

EUTRA/LTE/IoT

R&S[®]SMM-K55/-K84/-K85/-K112/- K113/-K115/-K119/-K143/-K146/-K175 User Manual



1179196402
Version 12

ROHDE & SCHWARZ
Make ideas real



This document describes the following software options:

- R&S®SMM-K55, LTE Rel. 8 (1441.1924.xx)
- R&S®SMM-K84, LTE Rel. 9 (1441.1882.xx)
- R&S®SMM-K85, LTE Rel. 10 (1441.1876.xx)
- R&S®SMM-K112, LTE Rel. 11 (1441.1847.xx)
- R&S®SMM-K113, LTE Rel. 12 (1441.1830.xx)
- R&S®SMM-K115, Cellular IoT Rel. 13 (1441.1818.xx)
- R&S®SMM-K119, LTE Rel. 13/14/15 (1441.1776.xx)
- R&S®SMM-K143, Cellular IoT Rel. 14 (1441.1747.xx)
- R&S®SMM-K146, Cellular IoT Rel. 15/16/17 (1441.1247.xx)
- R&S®SMM-K175, U-plane data generation (1441.1030.xx)

This manual describes firmware version FW 5.30.047.xx and later of the R&S®SMM100A.

© 2023 Rohde & Schwarz

Muehldorfstr. 15, 81671 Muenchen, Germany

Phone: +49 89 41 29 - 0

Email: info@rohde-schwarz.com

Internet: www.rohde-schwarz.com

Subject to change – data without tolerance limits is not binding.

R&S® is a registered trademark of Rohde & Schwarz GmbH & Co. KG.

All other trademarks are the properties of their respective owners.

1179.1964.02 | Version 12 | EUTRA/LTE/IoT

The following abbreviations are used throughout this description: R&S®SMM100A is abbreviated as R&S SMM, R&S®WinIQSIM2™ is abbreviated as R&S WinIQSIM2

Contents

1	Welcome to the EUTRA/LTE/loT options	11
1.1	Key features	11
1.2	Accessing the EUTRA/LTE dialog	13
1.3	What's new	13
1.4	Documentation overview	13
1.4.1	Getting started manual	13
1.4.2	User manuals and help	14
1.4.3	Service manual	14
1.4.4	Instrument security procedures	14
1.4.5	Printed safety instructions	14
1.4.6	Data sheets and brochures	14
1.4.7	Release notes and open source acknowledgment (OSA)	15
1.4.8	Application notes, application cards, white papers, etc.	15
1.4.9	Videos	15
1.5	Scope	16
1.6	Notes on screenshots	16
2	About the EUTRA/LTE options	17
2.1	Required options	17
2.2	Introduction to the EUTRA/LTE technology	18
2.2.1	LTE downlink transmission scheme	18
2.2.2	LTE uplink transmission scheme	32
2.2.3	LTE MIMO concepts	40
2.2.4	LTE MBMS concepts	44
2.2.5	LTE Release 10 (LTE-Advanced) introduction	44
2.2.6	LTE Release 11 introduction	49
2.2.7	LTE Release 12 introduction	52
2.2.8	LTE Release 13/14 introduction	53
3	Find out the implemented 3GPP specification	60
4	EUTRA/LTE configuration and settings	61
4.1	General settings	61

4.2	General DL settings / general TDD DL settings.....	68
4.2.1	PDSCH scheduling settings.....	69
4.2.2	DL carrier aggregation configuration.....	70
4.2.3	MBSFN settings.....	78
4.2.4	Physical settings.....	92
4.2.5	Cell-specific settings.....	96
4.2.6	TDD frame structure settings.....	100
4.2.7	Downlink signals settings.....	101
4.2.8	Antenna ports settings.....	125
4.3	DL frame configuration settings.....	127
4.3.1	General frame configuration settings.....	127
4.3.2	Dummy data configuration settings.....	129
4.3.3	User configuration settings.....	130
4.3.4	Auto sequence configuration.....	138
4.3.5	EPDCCH configuration settings.....	147
4.3.6	Scrambling configuration settings.....	152
4.3.7	SPS configuration settings.....	153
4.3.8	LAA settings.....	158
4.3.9	Subframe configuration settings.....	163
4.3.10	DL resource allocation table.....	164
4.3.11	PCFICH settings.....	171
4.3.12	PHICH settings.....	173
4.3.13	(E)PDCCH settings.....	176
4.3.14	(E)PDCCH format variable.....	180
4.3.15	DCI format configuration.....	189
4.4	Enhanced PBCH, PDSCH and PMCH settings.....	202
4.4.1	Precoding settings.....	203
4.4.2	CSI-RS settings.....	208
4.4.3	Scrambling settings.....	209
4.4.4	Channel coding settings.....	210
4.5	DL antenna port mapping settings.....	213
4.6	General UL settings.....	219
4.6.1	UL carrier aggregation configuration.....	219

4.6.2	Physical settings.....	225
4.6.3	Cell-specific settings.....	229
4.6.4	TDD frame structure settings.....	232
4.6.5	Signals settings.....	233
4.6.6	PRACH settings.....	237
4.6.7	PUSCH structure.....	239
4.6.8	PUCCH structure.....	240
4.7	UL frame configuration settings.....	243
4.7.1	General scheduling configuration settings.....	243
4.7.2	Subframe configuration.....	246
4.7.3	UL allocation table.....	248
4.8	User equipment configuration.....	253
4.8.1	Common settings.....	254
4.8.2	Physical uplink control channel (PUCCH).....	256
4.8.3	FRC configuration.....	257
4.8.4	Physical uplink shared channel (PUSCH).....	261
4.8.5	Demodulation reference signal (DMRS).....	266
4.8.6	Sounding reference signal (SRS).....	268
4.8.7	Sidelink settings.....	278
4.8.8	Antenna port mapping.....	304
4.8.9	PRACH power ramping.....	307
4.8.10	PRACH configuration.....	308
4.9	Enhanced PUSCH settings.....	311
4.9.1	Common PUSCH settings.....	311
4.9.2	Demodulation reference signal (DMRS).....	314
4.9.3	Channel coding / multiplexing.....	315
4.10	Enhanced PUCCH settings.....	321
4.10.1	Common settings.....	321
4.10.2	Channel coding / multiplexing.....	323
4.10.3	Demodulation reference signal (DMRS).....	327
5	Generating eMTC/NB-IoT signals.....	329
5.1	About eMTC.....	330
5.1.1	Physical layer.....	332

5.1.2	PBCH.....	333
5.1.3	PDSCH.....	333
5.1.4	MPDCCH.....	337
5.1.5	PUSCH.....	341
5.1.6	PUCCH.....	344
5.1.7	PRACH.....	346
5.2	About NB-IoT.....	347
5.2.1	Physical layer.....	348
5.2.2	NPSS and NSSS.....	351
5.2.3	NRS.....	352
5.2.4	NPBCH.....	353
5.2.5	NPDCCH.....	354
5.2.6	NPDSCH.....	358
5.2.7	NDRS.....	360
5.2.8	NPUSCH.....	361
5.2.9	NPRACH.....	364
5.3	eMTC/NB-IoT-specific configuration and settings.....	367
5.3.1	NB-IoT carrier allocation.....	368
5.3.2	NPBCH, NPDCCH and NPDSCH settings.....	375
5.3.3	FRC settings.....	405
5.3.4	NDMRS settings.....	408
5.3.5	NPUSCH settings.....	410
5.3.6	NPRACH settings.....	422
5.3.7	eMTC DL allocations settings.....	428
5.3.8	eMTC PUSCH settings.....	458
5.3.9	eMTC PUCCH settings.....	470
5.3.10	eMTC PRACH settings.....	477
6	Observing current allocations on the time plan.....	483
6.1	OFDMA time plan.....	483
6.2	SC-FDMA time plan.....	485
6.3	TDD time plan.....	486
6.4	eMTC/NB-IoT indication in the DL time plan.....	487
6.5	eMTC/NB-IoT indication in the UL time plan.....	490

6.6	TDD time plan.....	491
7	Performing BS tests according to TS 36.141.....	494
7.1	Introduction to conformance testing.....	494
7.1.1	UE conformance testing.....	494
7.1.2	BS conformance testing.....	496
7.1.3	Repeater conformance testing.....	496
7.2	Required options.....	496
7.3	Supported test cases.....	496
7.3.1	Generic structure of the description of the implemented test cases.....	497
7.4	Standard test setups.....	498
7.4.1	Standard test setup - one path.....	498
7.5	General considerations.....	498
7.6	User interface.....	502
7.6.1	Test case settings.....	502
7.6.2	Instrument settings.....	503
7.6.3	Frequency allocation settings.....	505
7.6.4	Wanted signal and cell-specific settings.....	505
7.6.5	Diagram.....	507
7.6.6	Apply settings.....	508
7.7	Transmitter characteristics (TS 36.141, chapter 6).....	508
7.7.1	Prior considerations.....	509
7.7.2	Introduction to the unwanted emissions tests.....	509
7.7.3	General workflow for carrying out a transmitter test.....	511
7.7.4	Interfering signal settings.....	512
7.7.5	Test case 6.7: transmitter intermodulation.....	514
7.8	Receiver characteristics (TS 36.141, chapter 7).....	516
7.8.1	Prior considerations.....	516
7.8.2	General workflow for carrying out a receiver test.....	518
7.8.3	Interfering signal settings.....	519
7.8.4	Test case 7.2: reference sensitivity level.....	522
7.8.5	Test case 7.3: dynamic range.....	523
7.8.6	Test case 7.4: in-channel selectivity (ICS).....	524
8	Generating user plane data.....	528

8.1	Required options.....	528
8.2	File format and folder structure.....	528
9	Signal control and signal characteristics.....	530
9.1	Time domain windowing settings.....	530
9.2	Filter/clipping/ARB settings.....	531
9.2.1	Filter settings.....	531
9.2.2	Clipping settings.....	537
9.2.3	ARB settings.....	538
9.3	Adjusting the signal power.....	539
9.3.1	General power-related settings overview.....	539
9.3.2	Downlink power-related settings overview.....	539
9.3.3	Uplink power-related settings overview.....	540
9.3.4	Power settings.....	541
9.4	Trigger settings.....	544
9.5	Marker settings.....	550
9.6	Clock settings.....	552
9.7	Local and global connectors settings.....	553
10	Remote-control commands.....	554
10.1	Primary commands.....	556
10.2	Filter/clipping/power.....	561
10.2.1	Filter settings.....	561
10.2.2	Clipping settings.....	565
10.2.3	Time domain windowing settings.....	566
10.2.4	Power settings.....	566
10.3	Clock.....	568
10.4	Timing configuration.....	569
10.5	Trigger.....	569
10.6	Marker.....	576
10.7	General TDD commands.....	578
10.8	General downlink commands.....	579
10.9	General uplink commands.....	592
10.10	DL frame configuration.....	604
10.11	DL MBFSN.....	613

10.12	DL carrier aggregation.....	625
10.13	CSI-RS.....	630
10.14	LAA and DRS.....	637
10.15	Enhanced PBCH, PDSCH, PMCH.....	647
10.16	Enhanced PCFICH, PHICH and PDCCH configuration.....	656
10.17	Auto sequence.....	689
10.18	UL frame configuration.....	701
10.19	UL carrier aggregation.....	707
10.20	UL enhanced.....	710
10.21	User configuration.....	727
10.22	EPDCCH.....	738
10.23	Dummy data configuration.....	742
10.24	SPS configuration.....	744
10.25	User equipment.....	745
10.26	Sidelink configuration.....	770
10.27	eMTC/NB-IoT commands.....	799
10.27.1	General IoT downlink.....	823
10.27.2	DL IoT frame configuration.....	843
10.27.3	General IoT uplink.....	893
10.27.4	IoT UE configuration.....	901
10.28	Test case wizard remote-control commands.....	932
	Annex.....	943
	A Conflict handling.....	943
A.1	Downlink.....	943
A.2	Uplink.....	944
A.3	DCI conflict handling.....	945
	B Subframes handling.....	948
B.1	Copy/paste subframe.....	948
B.2	Number of configurable subframes.....	948
B.3	Four configurable frames in uplink and downlink direction.....	949
B.3.1	Uplink direction.....	949
B.3.2	Downlink direction.....	951

Glossary: 3GPP specifications, references.....	953
List of commands.....	955
Index.....	979

1 Welcome to the EUTRA/LTE/loT options

The R&S SMM100A-K55/-K84/-K85/-K112/-K113/-K115/-K119/-K143/-K146/-K175 are firmware applications that add functionality to generate signals in accordance with the 3GPP standard EUTRA/LTE.

In the following, the terms LTE and EUTRA are used interchangeably.

1.1 Key features

Preamble

All supported **LTE** features are in line with 3GPP Release 14; the following official 3GPP specifications are implemented:

- 3GPP TS 36.211, version 15.6.0
- 3GPP TS 36.212, version 15.6.1
- 3GPP TS 36.213, version 15.6.0

The R&S SMM100A-K55/-K84/-K85/-K112/-K113/-K119 key features

The R&S SMM100A simulates EUTRA/LTE at the physical channel level. The following list gives an overview of the functions provided for generating an EUTRA/LTE signal:

- Supports FDD and TDD
- Intuitive user interface with graphical display of time plan
- Full support of P-SYNC, S-SYNC and DL reference signal derived from cell ID
- PBCH, PDSCH, (E)PDCCH, PCFICH, PHICH supported
- Downlink 256QAM for PDSCH and PMCH
- PDCCH with full DCI configuration (all DCI formats supported), incl. DCI format 1C for eIMTA-RNTI
- Channel coding and scrambling for PDSCH and PBCH (including MIB)
- Automatic PDSCH scheduling from DCI
- Automatic scheduling of downlink transmissions according to long HARQ patterns
- Full downlink MIMO and transmit diversity support
- Uplink MIMO support
- Supports PUSCH with channel coding and scrambling
- Configuration of all PRACH and PUCCH formats
- Fixed reference channels (FRC) in line with 3GPP [TS 36.141](#)
- Downlink test models (E-TMs) in line with 3GPP [TS 36.141](#), incl. E-TMs for 256QAM
- Test case wizard
- Simulation of single-layer, dual-layer and up to eight-layer beamforming scenarios (transmission modes 7, 8 and 9) on antenna ports 5 and 7 to 14

- Support of MBMS single frequency network (MBSFN) subframes on antenna port 4
- Generation of positioning reference signals (PRS) on antenna port 6
- Generation of LTE-Advanced downlink and uplink carrier aggregation scenarios (up to 5 carriers) with support for cross-carrier scheduling; incl. uplink carrier aggregation with mixed duplexing
- LTE-Advanced enhanced SC-FDMA with PUSCH/PUCCH synchronous transmission and clustered PUSCH
- Support of CSI reference signals
- Support of DL LAA bursts configuration
- Support of QAM256 in uplink

The R&S SMM100A-K115 key features

The R&S SMM100A simulates eMTC and NB-IoT at the physical channel level. The following is an overview of provided functions:

- Supports uplink eMTC and NB-IoT configuration, and downlink NB-IoT configuration for CAT-M1 and CAT-NB1 devices
- Supports IoT standalone configuration and mixed configuration with LTE
- Supports NB-IoT in-band and guard band operating modes
- Intuitive user interface with graphical display of time plan
- Support of coverage enhancement CE modes A and B and CE levels 0, 1 and 2
- Support of the new NB channels and synchronization signals (NPSS, NSSS and DL reference signal derived from NCell ID)
- MPBCH, PDSCH, PBCH supported
- DCI-based configuration of NPDCCH and NPDSCH
- Channel coding and scrambling for NPDCCH, NPDSCH and NPBCH (including SIB type 1)
- Supports NPUSCH with channel coding and scrambling
- NPRACH configuration
- Support of all specified modulation schemes

The R&S SMM100A-K143 key features

- 3GPP LTE Rel. 14 (eMTC and NB-IoT)
Introduces eMTC widebands and new types CAT-M2 and CAT-NB2 devices.

The R&S SMM100A-K146 key features

- 3GPP LTE Rel. 15/16/17 (NB-IoT)
Introduces NB-IoT TDD mode in UL, FDD NPRACH formats, early data transmission, NB-IoT wake up signal, scheduling request in uplink for NPUSCH F2, and NPUSCH modulation up to 16QAM.

This user manual contains a description of the functionality that the application provides, including remote control operation.

All functions not discussed in this manual are the same as in the base unit and are described in the R&S SMM100A user manual. The latest version is available at:

www.rohde-schwarz.com/manual/SMM100A

Installation

You can find detailed installation instructions in the delivery of the option or in the R&S SMM100A service manual.

1.2 Accessing the EUTRA/LTE dialog

To open the dialog with EUTRA/LTE settings

- ▶ In the block diagram of the R&S SMM100A, select "Baseband > EUTRA/LTE".
A dialog box opens that display the provided general settings.

The signal generation is not started immediately. To start signal generation with the default settings, select "State > On".

1.3 What's new

This manual describes firmware version FW 5.30.047.xx and later of the R&S®SMM100A.

Compared to the previous version 5.20.043, the EUTRA/LTE/IoT firmware application provides the following new features and changes:

- Support of 16QAM with NPUSCH for NB-IoT, see "[Modulation](#)" on page 415
- Time-based trigger added, see "[Time Based Trigger](#)" on page 546

1.4 Documentation overview

This section provides an overview of the R&S SMM100A user documentation. Unless specified otherwise, you find the documents at:

www.rohde-schwarz.com/manual/smm100a

1.4.1 Getting started manual

Introduces the R&S SMM100A and describes how to set up and start working with the product. Includes basic operations, typical measurement examples, and general information, e.g. safety instructions, etc. A printed version is delivered with the instrument.

1.4.2 User manuals and help

Separate manuals for the base unit and the software options are provided for download:

- **Base unit manual**
Contains the description of all instrument modes and functions. It also provides an introduction to remote control, a complete description of the remote control commands with programming examples, and information on maintenance, instrument interfaces and error messages. Includes the contents of the getting started manual.
- **Software option manual**
Contains the description of the specific functions of an option. Basic information on operating the R&S SMM100A is not included.

The contents of the user manuals are available as help in the R&S SMM100A. The help offers quick, context-sensitive access to the complete information for the base unit and the software options.

All user manuals are also available for download or for immediate display on the Internet.

1.4.3 Service manual

Describes the performance test for checking compliance with rated specifications, firmware update, troubleshooting, adjustments, installing options and maintenance.

The service manual is available for registered users on the global Rohde & Schwarz information system (GLORIS):

<https://gloris.rohde-schwarz.com>

1.4.4 Instrument security procedures

Deals with security issues when working with the R&S SMM100A in secure areas. It is available for download on the internet.

1.4.5 Printed safety instructions

Provides safety information in many languages. The printed document is delivered with the product.

1.4.6 Data sheets and brochures

The data sheet contains the technical specifications of the R&S SMM100A. It also lists the options and their order numbers and optional accessories.

The brochure provides an overview of the instrument and deals with the specific characteristics.

See www.rohde-schwarz.com/brochure-datasheet/smm100a

1.4.7 Release notes and open source acknowledgment (OSA)

The release notes list new features, improvements and known issues of the current firmware version, and describe the firmware installation.

The software makes use of several valuable open source software packages. An open-source acknowledgment document provides verbatim license texts of the used open source software.

See www.rohde-schwarz.com/firmware/smm100a

1.4.8 Application notes, application cards, white papers, etc.

These documents deal with special applications or background information on particular topics.

See www.rohde-schwarz.com/application/smm100a

1.4.9 Videos

Find various videos on Rohde & Schwarz products and test and measurement topics on YouTube: <https://www.youtube.com/@RohdeundSchwarz>



On the menu bar, search for your product to find related videos.

HOME VIDEOS SHORTS PLAYLISTS COMMUNITY CHANNELS ABOUT

Figure 1-1: Product search on YouTube

1.5 Scope



Tasks (in manual or remote operation) that are also performed in the base unit in the same way are not described here.

In particular, it includes:

- Managing settings and data lists, like saving and loading settings, creating and accessing data lists, or accessing files in a particular directory.
- Information on regular trigger, marker and clock signals and filter settings, if appropriate.
- General instrument configuration, such as checking the system configuration, configuring networks and remote operation
- Using the common status registers

For a description of such tasks, see the R&S SMM100A user manual.

1.6 Notes on screenshots

When describing the functions of the product, we use sample screenshots. These screenshots are meant to illustrate as many as possible of the provided functions and possible interdependencies between parameters. The shown values may not represent realistic usage scenarios.

The screenshots usually show a fully equipped product, that is: with all options installed. Thus, some functions shown in the screenshots may not be available in your particular product configuration.

2 About the EUTRA/LTE options

For better understanding of the required configuration settings, this section lists:

- Some background information on basic terms and principles used in the EUTRA/LTE technology
- Information on functions specific to the instrument

2.1 Required options

The basic equipment layout for generating LTE signals includes the:

- Baseband Generator(R&S SMM-B9)
- Frequency option (e.g. R&S SMM-B1006)
- Baseband real-time extension (R&S SMM-K520)
- Digital standard EUTRA/LTE release 8 (R&S SMM-K55)

The following options are required to **support all LTE-related settings** described in this user manual:

- Baseband Generator(R&S SMM-B9)
- Frequency option (e.g. R&S SMM-B1006)
- Option LTE release 8 (R&S SMM-K55)
- Option LTE release 9 (R&S SMM-K84)
- Option LTE release 10 (R&S SMM-K85)
- Option LTE release 11 (R&S SMM-K112)
- Option LTE release 12 (R&S SMM-K113)
- Option LTE release 13/14/15 (R&S SMM-K119)
- O-RAN: U-plane generation (R&S SMM-K175)
- Option cellular IoT release 13 (R&S SMM-K115)
- Option cellular IoT release 14 (R&S SMM-K143)
- Option cellular IoT release 15/16/17 (R&S SMM-K146)

Further options are required to perform all test cases implemented in the "Test Case Wizard", see [Chapter 7.2, "Required options"](#), on page 496.

You can generate signals via play-back of waveform files at the signal generator. To create the waveform file using R&S WinIQSIM2, you do not need a specific option.

To play back the waveform file at the signal generator, you have two options:

- Install the R&S WinIQSIM2 option of the digital standard, e.g. R&S SMM-K255 for playing LTE waveforms
- If supported, install the real-time option of the digital standard, e.g. R&S SMM-K55 for playing LTE waveforms

For more information, see data sheet.

2.2 Introduction to the EUTRA/LTE technology

This section provides an introduction to the EUTRA/LTE technology.

2.2.1 LTE downlink transmission scheme

The downlink transmission scheme for E-UTRA FDD and TDD modes is based on conventional OFDM. In an OFDM system, the available spectrum is divided into multiple subcarriers, which are orthogonal to each other. Each of the subcarriers is independently modulated by a low rate data stream.

The OFDM signal is generated using the inverse fast Fourier transform (IFFT) digital signal processing. The IFFT converts a number N of complex data symbols used as frequency domain bins into the time domain signal. Such an N -point IFFT is illustrated on Figure 2-1.

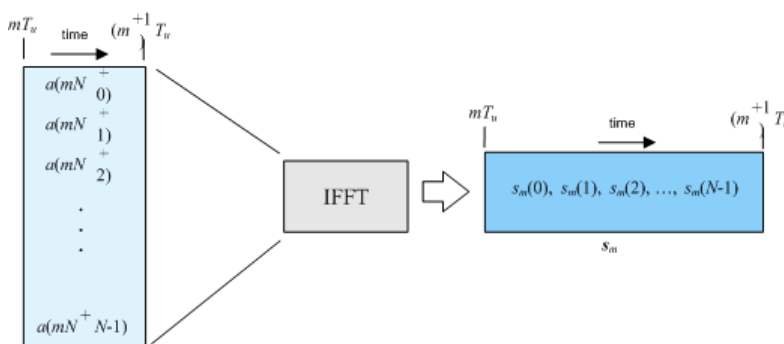

Figure 2-1: OFDM useful symbol generation using an IFFT (3GPP TR 25.892)

$a(mN+n)$ = n^{th} subchannel modulated data symbol
 $mT_u < t \leq (m+1)T_u$ = time period

The vector s_m is defined as the useful OFDM symbol. It is the time superposition of the N narrowband modulated subcarriers. Therefore, from a parallel stream of N sources of data, each one independently modulated, a waveform composed of N orthogonal subcarriers is obtained. Each of the subcarriers is a frequency sinc function.

The Figure 2-2 illustrates the mapping from a serial stream of QAM symbols to N parallel streams, used as frequency domain bins for the IFFT. The N -point time domain blocks obtained from the IFFT are then serialized to create a time domain signal. Not shown in the figure is the process of cyclic prefix insertion.

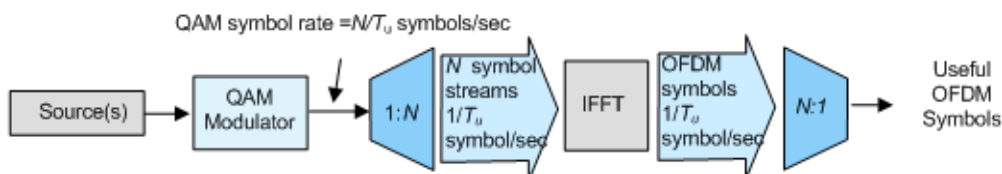

Figure 2-2: OFDM signal generation chain (3GPP TR 25.892)

In contrast to an OFDM transmission scheme, OFDMA allows the access of multiple users on the available bandwidth. Each user is assigned a specific time-frequency resource. As a fundamental principle of E-UTRA, the data channels are shared channels. For each transmission time interval of 1 ms, a new scheduling decision is taken regarding which users are assigned to which time/frequency resources during this transmission time interval.

2.2.1.1 OFDMA parameterization

Two radio frame structures, one for FDD (frame structure type 1) and one for TDD (frame structure type 2) mode are defined. These EUTRA frame structures are described in [TS 36.211](#).

Channel bandwidth

OFDMA physical layer parameterization is based on a bandwidth agnostic layer 1. However, current 3GPP specifications focus on the channel bandwidth listed in [Table 2-1](#).

The bandwidth is expressed as number of resource blocks in the range from 6 to 110 resource blocks (RB), which results in bandwidths from 1.08 MHz to 19.8 MHz.

Table 2-1: Channel bandwidth according to 3GPP TS 36.804

Channel bandwidth	1.4 MHz	3 MHz	5 MHz	10 MHz	15 MHz	20 MHz
Number of RBs	6	12	25	50	75	100
Number of occupied subcarriers	73	181	301	601	901	1201
FFT size	128, 256, 512, 1024, 2048	256, 512, 1024, 2048	512, 1024, 2048	1024, 2048	1536, 2048	2048

Frame structure type 1 (FDD)

The FDD frame structures type 1 is based on a 10 ms radio frame that is divided into 20 equally sized slots of 0.5 ms. A subframe consists of two consecutive slots, so one radio frame contains 10 subframes.

[Frame format 1 \(FDD mode\)](#) illustrates frame structure type 1 (T_s is expressing the basic time unit corresponding to 30.72 MHz). Frame format 1 is applicable to both full and half duplex FDD.

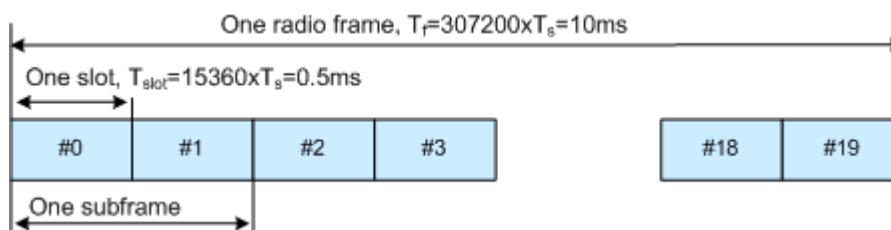

Figure 2-3: Frame format 1 (FDD mode)

Related settings

See:

- "Duplexing" on page 64
- Chapter 4.3, "DL frame configuration settings", on page 127
- Chapter 6.1, "OFDMA time plan", on page 483.

Frame structure type 2 (TDD)

The TDD frame format 2 is based on a 10 ms radio frame, but the frame is divided into two half-frames, 5 ms each. Each half-frame consists of five 1 ms long subframes, which are reserved either for downlink or uplink transmission or are carrying special information (see Figure 2-4).

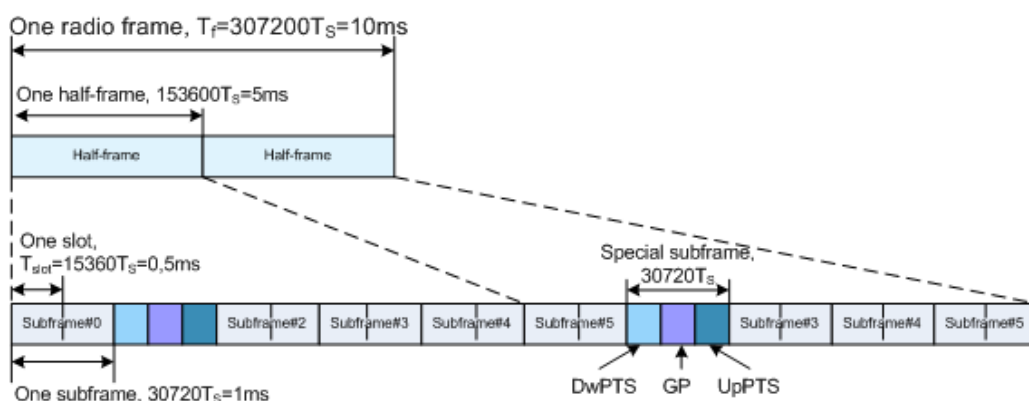

Figure 2-4: Frame format 2 (TDD mode), 5 ms switching periodicity

All non-special subframes are divided into two 0.5 ms long slots. The special subframes consist of three fields DwPTS (downlink pilot timeslot), GP (guard period), and UpPTS (uplink pilot timeslot). The length of these fields can vary in specified limits so that the total special subframe's length is maintained constant (1 ms). The 3GPP specification defines 10 special subframe configurations for normal cyclic prefix type and eight for extended cyclic prefix type. These subframe configurations specify the allowed DwPTS/GP/UpPTS lengths' combinations.

The 3GPP specification defines seven different uplink-downlink configurations, i.e. defines the downlink-to-uplink switch-point periodicity (5 ms or 10 ms) and the allowed combination of downlink, uplink, and special slots. In all the uplink-downlink configurations and for any downlink-to-uplink switch-point periodicity, subframe 0, subframe 5, and DwPTS are always reserved for downlink transmission. UpPTS and the subframe following the special subframe are always reserved for uplink transmission.

Figure 2-5 shows the supported uplink-downlink configurations according to TS 36.211.

UL/DL Configuration	Downlink-to-Uplink Switch-point periodicity	Subframe number									
		0	1	2	3	4	5	6	7	8	9
0	5 ms	D	S	U	U	U	D	S	U	U	U
1	5 ms	D	S	U	U	D	D	S	U	U	D
2	5 ms	D	S	U	D	D	D	S	U	D	D
3	10 ms	D	S	U	U	U	D	D	D	D	D
4	10 ms	D	S	U	U	D	D	D	D	D	D
5	10 ms	D	S	U	D	D	D	D	D	D	D
6	5 ms	D	S	U	U	U	D	S	U	U	D

Figure 2-5: Uplink-downlink configurations

D = Denotes a subframe reserved for downlink transmission

U = Denotes a subframe reserved for uplink transmission

S = Denotes the special subframe

Related settings

See:

- ["Duplexing"](#) on page 64
- [Chapter 4.2.6, "TDD frame structure settings"](#), on page 100
- [Chapter 6.3, "TDD time plan"](#), on page 486.

2.2.1.2 Downlink resource grid

The [Figure 2-6](#) shows the structure of the downlink resource grid for one downlink slot. The available downlink bandwidth consists of $N_{\text{DL}_{\text{BW}}}^{\text{DL}}$ subcarriers with a spacing of $\Delta f = 15$ kHz. In the case of multi-cell MBMS transmission, a subcarrier spacing of $\Delta f = 7.5$ kHz is also possible. $N_{\text{DL}_{\text{BW}}}^{\text{DL}}$ can vary to allow for bandwidth operation up to 20 MHz.

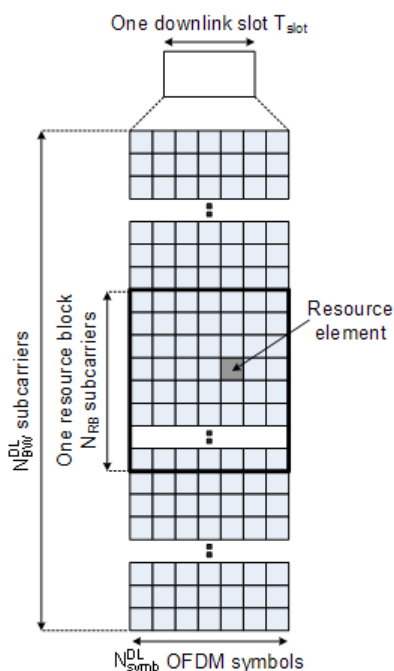

Figure 2-6: Downlink resource grid (3GPP TS 36.211)

One downlink slot consists of N_{Symb}^{DL} OFDM symbols. To each symbol, a cyclic prefix (CP) is appended as guard time. N_{Symb}^{DL} depends on the cyclic prefix length. The generic frame structure with normal cyclic prefix length contains $N_{Symb}^{DL} = 7$ symbols. This translates into a cyclic prefix length of $T_{CP} \approx 5.2 \mu s$ for the first symbol and $T_{CP} \approx 4.7 \mu s$ for the remaining six symbols. Additionally, an extended cyclic prefix is defined to cover large cell scenarios with higher delay spread and MBMS transmission. The generic frame structure with extended cyclic prefix of $T_{CP-E} \approx 16.7 \mu s$ contains $N_{Symb}^{DL} = 6$ OFDM symbols (subcarrier spacing 15 kHz). The generic frame structure with extended cyclic prefix of $T_{CP-E} \approx 33.3 \mu s$ contains $N_{Symb}^{DL} = 3$ symbols (subcarrier spacing 7.5 kHz). The Table 2-2 gives an overview of the different parameters for the generic frame structure.

Table 2-2: Parameters for downlink generic frame structure

Configuration	Number of symbols N_{Symb}^{DL}	Cyclic prefix length, samples	Cyclic prefix length, us
Normal cyclic prefix $\Delta f = 15$ kHz	7	160 for first symbol 144 for other symbols	5.2 us for first symbol 4.7 us for other symbols
Extended cyclic prefix $\Delta f = 15$ kHz	6	512	16.7 us
Extended cyclic prefix $\Delta f = 7.5$ kHz	3	1024	33.3 us

Related settings

See:

- [Chapter 6.1, "OFDMA time plan"](#), on page 483
- [Chapter 6.3, "TDD time plan"](#), on page 486

2.2.1.3 Downlink data transmission

Data is allocated to the UEs in terms of resource blocks. A physical resource block consists of 12 (24) consecutive subcarriers in the frequency domain for the $\Delta f = 15$ kHz ($\Delta f = 7.5$ kHz) case. In the time domain, a physical resource block consists of DL N_{symp} consecutive OFDM symbols, see [Figure 2-6](#). $N_{\text{symp}}^{\text{DL}}$ is equal to the number of OFDM symbols in a slot. The resource block size is the same for all bandwidths, therefore the number of available physical resource blocks depends on the bandwidth. Depending on the required data rate, each UE can be assigned one or more resource blocks in each transmission time interval of 1 ms. The scheduling decision is done in the base station (eNodeB). The user data is carried on the physical downlink shared channel (PDSCH).

Related settings

See [Chapter 4.4, "Enhanced PBCH, PDSCH and PMCH settings"](#), on page 202.

2.2.1.4 Downlink control information transmission

Control information is mapped to the resource elements in terms of resource elements groups (REG). A REG consists of four consequent resource elements within one resource block which are not used for cell-specific reference signals. Thus, there are two types of resource blocks, resource blocks containing three REGs and resource blocks containing only two REGs.

Two REGs are available within the OFDM symbols with allocated reference signals. These are the OFDM symbol 0 in the first slot in a subframe and in the OFDM symbol 1 in the four-antenna system case. 3 REGs are then available in the OFDM symbols 2 and in the OFDM symbol 1 if one- or two-antenna system are used (see [Figure 2-7](#) and [Figure 2-9](#)).

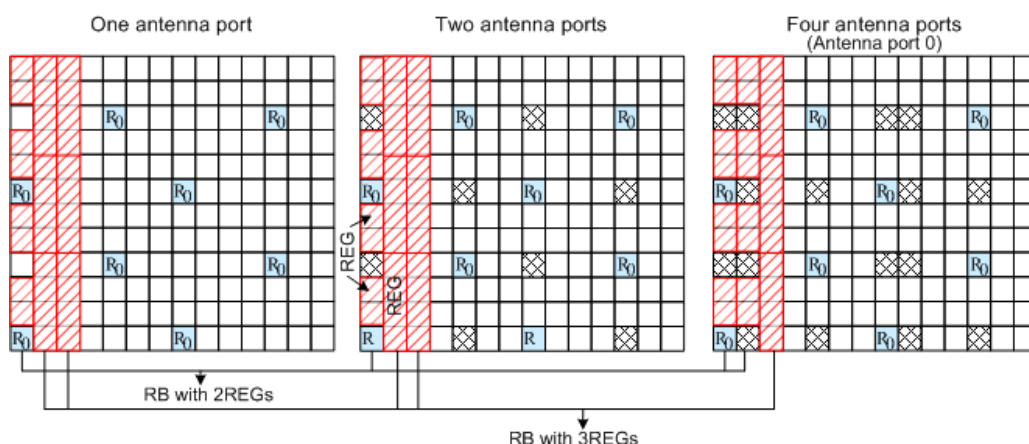

Figure 2-7: Resource elements groups (REG)

Three physical DL channels are carrying the control information: the Physical Control Format Indicator Channel (PCFICH), the Physical Hybrid ARQ Indicator Channel (PHICH) and the Physical Downlink Control Channel (PDCCH).

- The **PCFICH** carries the information about the number of OFDM symbols used for transmission of PDCCH in a subframe and is mapped to four REGs within the first OFDM symbol.
- The **PHICH** carries the HARQ ACK/NACK messages and is transmitted in terms of PHICH groups. A PHICH group uses three REGs. For normal CP, a PHICH group consists of up to eight ACK/NACK messages. Four ACK/NACK messages are carried by one PHICH group if an extended CP is used.

For frame format 1 and non-MBSFN transmission, the PHICH can be transmitted:

- Over only the first OFDM symbol (or the so called normal PHICH duration).
- In case of extended PHICH duration, over the first three OFDM symbols.

- Downlink control signaling on the Physical Downlink Control Channel (**PDCCH**) is used to convey the scheduling decisions to individual UEs. The PDCCH is located in the first OFDM symbols of a slot.

The maximum number of OFDM symbols used for the transmission of a PDCCH is determined by the number of RB used:

- For channel bandwidth with ≤ 10 RBs, four OFDM symbols are necessary (OFDM symbol 0 to 3)
- For channel bandwidths with ≥ 10 RBs, three OFDM symbols are sufficient (OFDM symbol 0 to 2).

The minimum number of OFDM symbols used for the transmission of a PDCCH is determined by the PHICH duration and the channel bandwidth.

The PDCCH is mapped to the REGs not used for PHICH and PCFICH and transmitted on one or several control channel elements (CCEs), where a CCE corresponds to 9 REGs.

Related settings

See:

- "[PHICH Duration](#)" on page 77

- [Chapter 4.3.1, "General frame configuration settings"](#), on page 127.

2.2.1.5 Downlink reference signal structure and cell search

The downlink reference signal structure is important for cell search, channel estimation, and neighbor cell monitoring.

For the LTE downlink, five types of reference signals are defined:

- [Cell-specific downlink reference signals](#)
The cell-specific reference signals are common signals in a cell, that are intended for all UE within this cell.
- [MBSFN reference signals](#)
These reference signals are used for channel estimation and demodulation of signals transmitted by MBSFN.
- [UE-specific reference signal \(DMRS\)](#)
These reference signals are intended for a specific user.
- [Positioning reference signals](#)
- [CSI reference signals](#)
These reference signals are intended channel quality measurements and frequency-dependent scheduling.

Related settings

See:

- ["Downlink Reference Signal Structure"](#) on page 102
- [Chapter 4.2.7.3, "Positioning reference signal \(PRS\) settings"](#), on page 104
- [Chapter 4.2.7.4, "CSI-RS settings"](#), on page 108.

Mapping of reference signals to antenna ports

The LTE standard specifies so-called antenna ports (AP). Antenna ports are logical elements, used to describe identical propagation conditions. The mapping of these antenna ports to the physical antennas is not specified by 3GPP.

LTE specifies AP 0 to AP 5 and defines one reference signal per downlink antenna port (see [Table 2-3](#)). LTE-Advanced introduces new reference signals, new control channels and defines additional antenna ports, AP 6 to AP 22 and AP 107 to AP 110.

From LTE Rel. 14 on, also the AP 23 to AP 46 are supported and the multiple CSI-RS configuration mapped on them. See also [Chapter 2.2.8, "LTE Release 13/14 introduction"](#), on page 53.

Table 2-3: Mapping of reference signals to antenna ports

Antenna port (AP)	Reference signal
AP 0 to AP 3	Cell-specific reference signals (CS-RS)
AP 4	MBSFN-RS
AP 5	UE-specific reference signals (DMRS) for single-layer transmission (TM7)

Antenna port (AP)	Reference signal
AP 6	Positioning reference signals (PRS)
AP 7 to AP 8	UE-specific reference signals (DMRS) for up to 2 layers beamforming (TM8/TM9/TM10)
AP 9 to AP 14	UE-specific reference signals (DMRS) for multi-layer beamforming (TM9/TM10)
AP 15 to AP 22 AP 23 to AP 46	Channel state information reference signals (CSI-RS)
AP 107 to AP 110	Demodulation reference signal associated with EPDCCH

The [Figure 2-8 \[1MA169\]](#) illustrates the mapping of the logical antenna ports to physical transmit antennas.

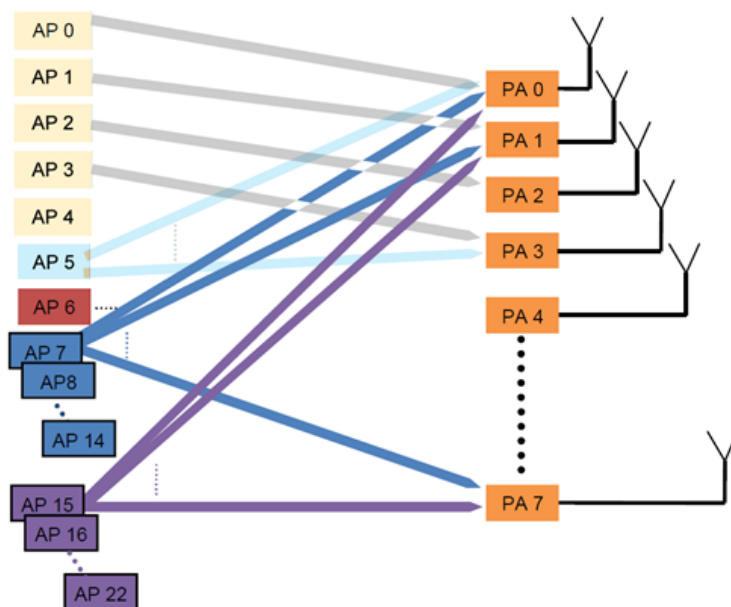

Figure 2-8: Mapping of logical antenna ports to physical transmit antennas (3GPP Rel. 10)

AP = Antenna port
PA = Physical antenna

See also:

- [Table 2-6](#)
- [Chapter 2.2.5, "LTE Release 10 \(LTE-Advanced\) introduction"](#), on page 44

Related settings

See [Chapter 4.5, "DL antenna port mapping settings"](#), on page 213.

Cell-specific downlink reference signals

The [Figure 2-9](#) shows the principle of the downlink reference signal structure for one-antenna, two-antenna, and four-antenna transmission (antenna ports 0 to 3, AP 0 to

AP 3). Specific predefined resource elements in the time-frequency domain carry the reference signal sequence. Besides first reference symbols, there can be a need for second reference symbols. The different colors in the figure represent the sequences transmitted from up to four transmit antennas.

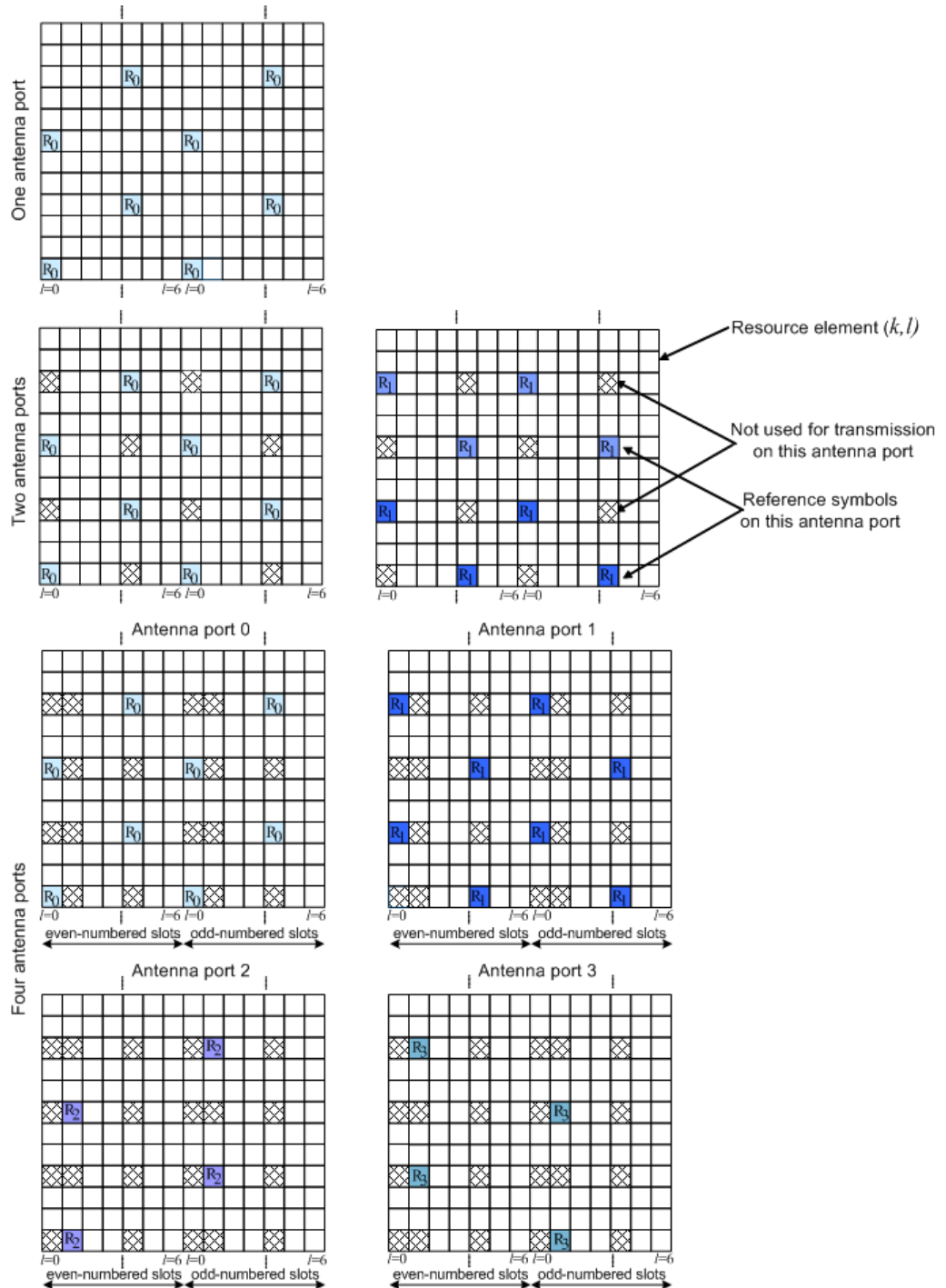

Figure 2-9: Downlink reference signal structure (normal cyclic prefix)

The reference signal sequence carries the cell identity. There are 504 unique physical layer cell identities, grouped into 168 unique physical cell identity groups that contain three unique identities each. Each reference signal is generated as a pseudo-random sequence that depends on the physical layer cell identity.

Frequency hopping can be applied to the downlink reference signals. The frequency hopping pattern has a period of one frame (10 ms).

During cell search, the handset identifies different types of information: symbol and radio frame timing, frequency, cell identification, overall transmission bandwidth, antenna configuration, and cyclic prefix length.

Besides the reference signals, synchronization signals are therefore needed during cell search. EUTRA uses a hierarchical cell search scheme similar to WCDMA. This means that the synchronization acquisition and the cell group identifier are obtained from different SYNC signals. Thus, a primary synchronization signal (**P-SYNC** or **PSS**) and a secondary synchronization signal (**S-SYNC** or **SSS**) are defined with a predefined structure. They are transmitted on the 72 center subcarriers (around DC sub-carrier) within the same predefined slots (twice per 10 ms) on different resource elements, see [Figure 2-10](#). This figure is taken from [TS 36.211](#).

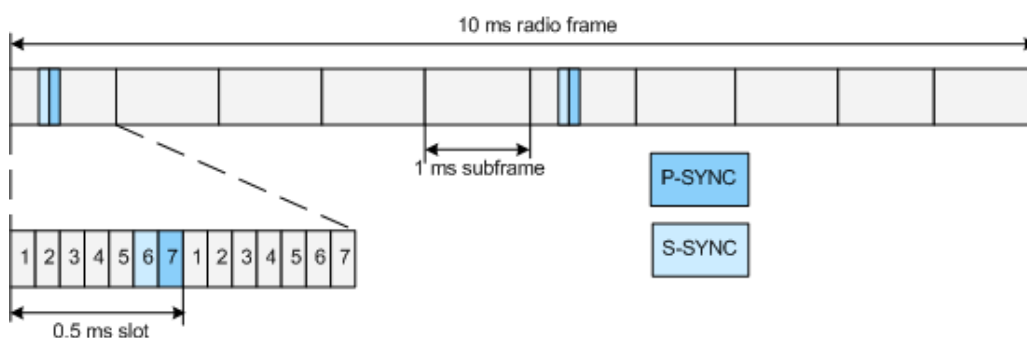

Figure 2-10: P-SYNC and S-SYNC structure (normal CP; 1.25 MHz bandwidth)

As additional help during cell search, a common control physical channel (CCPCH) is available which carries BCH type of information, e.g. system bandwidth. It is transmitted at predefined time instants on the 72 subcarriers centered on the DC subcarrier.

To enable the UE to support this cell search concept, it was agreed to have a minimum UE bandwidth reception capability of 20 MHz.

Related settings

See "[Synchronization Signal Settings](#)" on page 102.

MBSFN reference signals

MBSFN reference signals are defined for extended cyclic prefix only. The MBSFN reference signals are transmitted on antenna port 4 (AP 4) and only when the PMCH is transmitted.

The [Figure 2-11](#) shows the resource elements used by the MBSFN reference signal if $\Delta f = 15$ kHz.

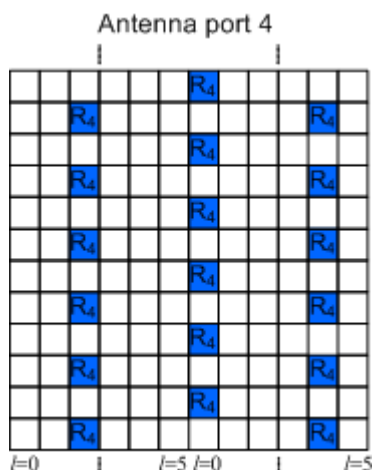

Figure 2-11: MBSFN reference signal structure (extended cyclic prefix, carrier spacing 15 KHz)

Related settings

See [Chapter 4.2.3, "MBSFN settings"](#), on page 78.

UE-specific reference signal (DMRS)

These reference signals are intended for a specific user and mapped to predefined PDSCH RBs of this particular user. The resource elements predefined for the UE-specific RS do not overlap with the resource elements reserved for the cell-specific reference signals.

For single-antenna transmission, the UE-specific reference signals are transmitted on antenna port 5, 7 or 8 (AP 5, AP 7, and AP 8). If a spatial multiplexing is applied, the UE-specific reference signals are transmitted on antenna ports 7 to 10 (AP 7 to AP 10).

The UE-specific RS are also called demodulation reference signals (DMRS) and are intended for channel estimation and demodulation instead of the common reference signals. One typical example of the application of UE-specific RS is the channel estimation and demodulation, if beamforming transmission is used. This is also called transmission using antenna port 5 (AP 5).

In contrary to the common reference signals that are not precoded, the UE-specific RS are precoded in the same way as the PDSCH they are mapped to.

See [Figure 2-12](#) and [Figure 2-13](#) for illustration of the mapping of the UE-specific reference signals to the resource elements.

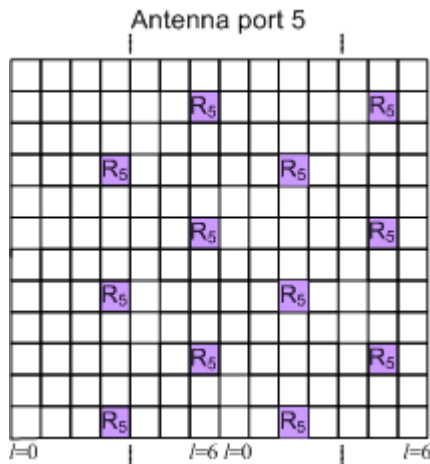

Figure 2-12: UE-specific reference signals, antenna port 5 (normal cyclic prefix)

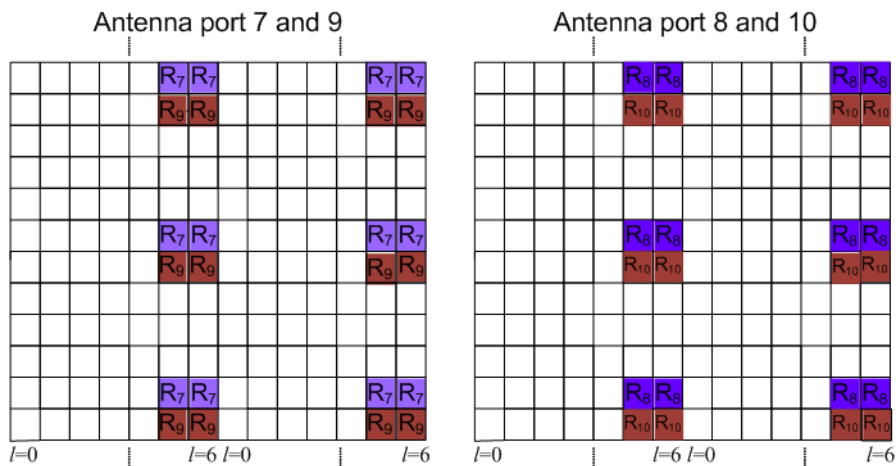

Figure 2-13: UE-specific reference signals, antenna ports 7 to 10 (normal cyclic prefix, downlink sub-frame)

See also "Transmission mode TM10 and DCI format 2D" on page 51.

Positioning reference signals

The positioning reference signals are transmitted only in downlink subframes configured for positioning reference signals transmission. Positioning reference signals are transmitted on antenna port 6 (AP 6).

The Figure 2-14 shows the mapping of the positioning reference signals for the one and two PBCH antenna ports case (normal cyclic prefix). Refer to the specification for information about the mapping in all other cases.

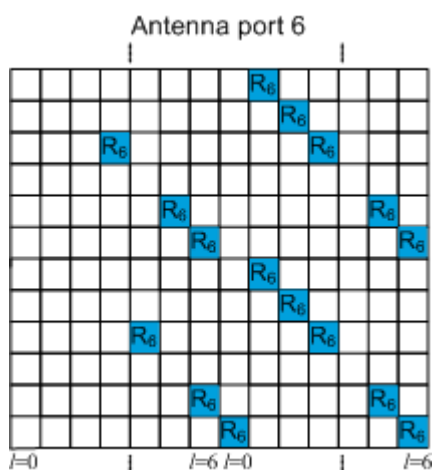

Figure 2-14: Mapping of PRS (normal cyclic prefix), one and two PBCH antenna ports.

Related settings

See [Chapter 4.2.7.3, "Positioning reference signal \(PRS\) settings"](#), on page 104 .

CSI reference signals

The CSI reference signals (CSI-RS) are intended for the acquisition of channel-state information (CSI) for UE working in transmission mode 9 or 10 (TM9 or TM10). This is because in TM9, the DMRS are used for channel estimation.

The CSI-RS structure depends on the number of CSI-RS (1, 2, 4 or 8) configured in a cell and can differ between the cells. This is illustrated on [Figure 2-15 \[TS 36.211\]](#).

Up to LTE Rel. 13, the CSI-RS are transmitted on antenna ports 15 to 22 (AP 15 to AP 22).

From LTE Rel. 14 on, also the AP 23 to AP 46 are supported and the multiple CSI-RS configuration mapped on them. See also [Chapter 2.2.8, "LTE Release 13/14 introduction"](#), on page 53.

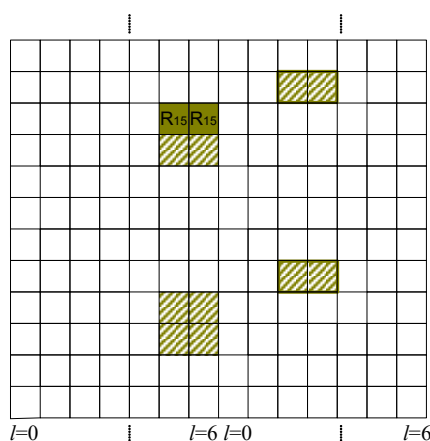

Figure 2-15: Mapping of a CSI-RS on antenna port 15 (CSI configuration 0, normal cyclic prefix)

Pattern = Example of possible position of the CSI-RSs
Dark green = Example of allocated CSI-RS signals in a cell
Border = Example of muted (ZeroTxPower) CSI-RSs

The CSI-RS can be configured with different transmission periods (5 ms to 80 ms) and per subframe (see [Table 4-3](#)).

In normal operation, the CSI-RS is transmitted on the allocated resource elements (dark green color on [Figure 2-15](#)). The remaining possible but not allocated resource elements (the pattern elements on the same figure) are used for PDSCH transmission. The 3GPP specification allows the configuration of an extra subset of resource elements. These resource elements are reserved for CSI-RS transmission and have the same structure as the CSI-RS but use a zero transmission power (ZeroTxPower). Nothing is transmitted during these resource elements.

Related settings

See:

- [Chapter 4.2.7.4, "CSI-RS settings"](#), on page 108
- [Chapter 4.4.2, "CSI-RS settings"](#), on page 208
- ["CSI Awareness State"](#) on page 136

2.2.1.6 Downlink physical layer procedures

For E-UTRA, the following downlink physical layer procedures are especially important:

- **Cell search and synchronization**
See ["Cell-specific downlink reference signals"](#) on page 26.
- **Scheduling**
Scheduling is done in the base station (eNodeB). The downlink control channel PDCCH informs users about their allocated time/frequency resources and the transmission formats to use. The scheduler evaluates different types of information, e.g. quality-of-service parameters, measurements from the UE, UE capabilities, and buffer status.
- **Link adaptation**
Link adaptation is already known from HSDPA as adaptive modulation and coding. Also in E-UTRA, modulation and coding for the shared data channel is not fixed, but rather is adapted according to radio link quality. For this purpose, the UE regularly reports channel quality indications (CQI) to the eNodeB.
- **Hybrid automatic repeat request (ARQ)**
Downlink hybrid ARQ is also known from HSDPA. It is a retransmission protocol. The UE can request retransmissions of incorrectly received data packets.

2.2.2 LTE uplink transmission scheme

During the study item phase of LTE, alternatives for the optimum uplink transmission scheme were investigated. While OFDMA is seen optimum to fulfill the LTE requirements in downlink, OFDMA properties are less favorable for the uplink. This is due to

weaker peak-to-average power ratio (PAPR) properties of an OFDMA signal, resulting in worse uplink coverage.

Thus, the LTE uplink transmission scheme for FDD and TDD mode is based on SC-FDMA (single carrier frequency division multiple access) with cyclic prefix. SC-FDMA signals have better PAPR properties compared to an OFDMA signal. This was one of the main reasons for selecting SC-FDMA as LTE uplink access scheme. The PAPR characteristics are important for cost-effective design of UE power amplifiers. Still, SC-FDMA signal processing has some similarities with OFDMA signal processing, so parameterization of downlink and uplink can be harmonized.

There are different possibilities how to generate an SC-FDMA signal. DFT-spread-OFDM (DFT-s-OFDM) has been selected for EUTRA. The principle is illustrated on [Figure 2-16](#). This figure is taken from 3GPP R1-050584, "EUTRA Uplink Numerology and Design".

For DFT-s-OFDM, a size-M DFT is first applied to a block of M modulation symbols. QPSK, 16QAM and 64 QAM are used as uplink EUTRA modulation schemes, the latter being optional for the UE. The DFT transforms the modulation symbols into the frequency domain. The result is mapped onto the available subcarriers. In EUTRA uplink, only localized transmission on consecutive subcarriers is allowed. An N point IFFT where $N > M$ is then performed as in OFDM, followed by addition of the cyclic prefix and parallel to serial conversion.

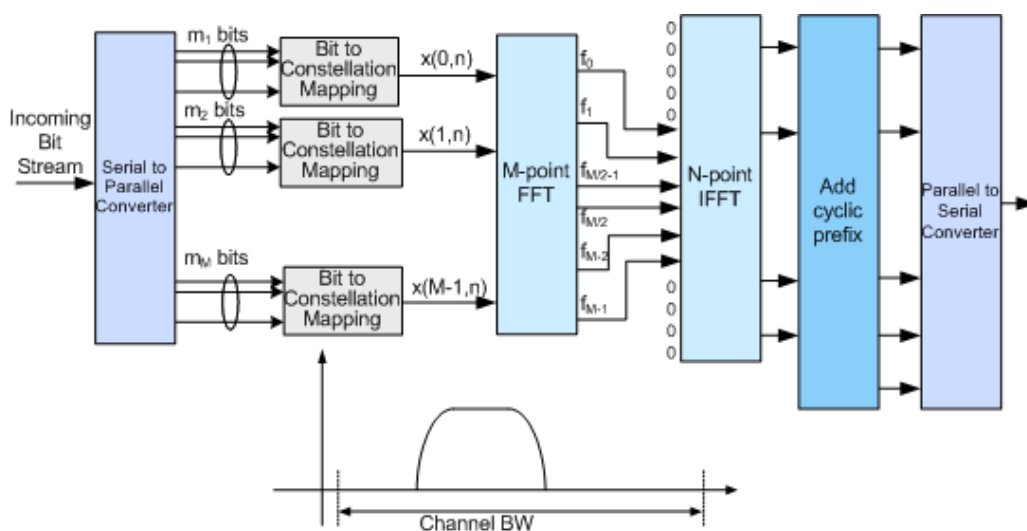

Figure 2-16: Block diagram of DFT-s-OFDM (localized transmission)

The DFT processing is therefore the fundamental difference between SC-FDMA and OFDMA signal generation. This is indicated by the term DFT-spread-OFDM. In an SCFDMA signal, each subcarrier used for transmission contains information of all transmitted modulation symbols. This is due to the fact that the input data stream has been spread by the DFT transform over the available subcarriers. In contrast, each subcarrier of an OFDMA signal only carries information related to specific modulation symbols.

2.2.2.1 SC-FDMA parameterization

The EUTRA uplink structure is similar to the downlink. An uplink radio frame consists of 20 slots of 0.5 ms each, and 1 subframe consists of 2 slots. The slot structure is shown on [Figure 2-17](#) (taken from TS 36.211).

Each slot carries $N_{\text{symbol}}^{\text{UL}}$ SC-FDMA symbols, where $N_{\text{symbol}}^{\text{UL}} = 7$ for the normal cyclic prefix and $N_{\text{symbol}}^{\text{UL}} = 6$ for the extended cyclic prefix. SC-FDMA symbol number 3 (i.e. the 4th symbol in a slot) carries the reference signal for channel demodulation.

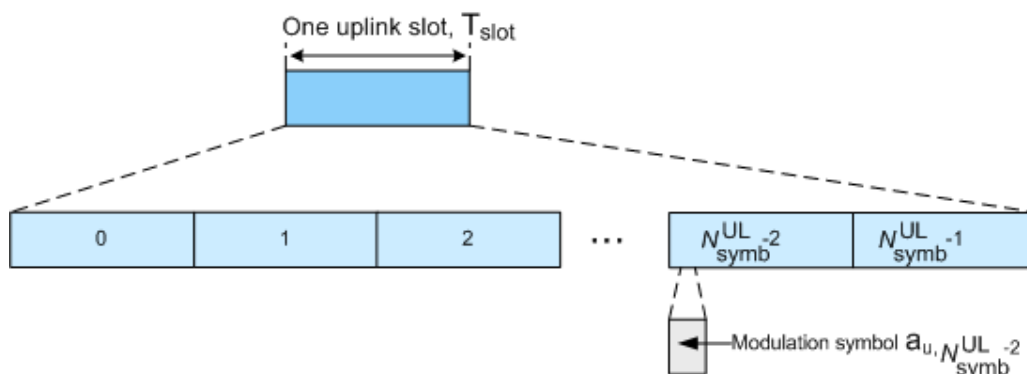

Figure 2-17: Uplink slot structure

Also for the uplink, a bandwidth agnostic layer 1 specification has been selected. The table below shows the configuration parameters in an overview table.

Configuration	Number of symbols $N_{\text{symbol}}^{\text{UL}}$	Cyclic prefix length in samples	Cyclic prefix length in μs
Normal cyclic prefix $\Delta f = 15 \text{ kHz}$	7	160 for first symbol 144 for other symbols	5.2 μs for first symbol 4.7 μs for other symbols
Extended cyclic prefix $\Delta f = 15 \text{ kHz}$	6	512	16.7 μs

Related settings

See:

- [Chapter 4.1, "General settings"](#), on page 61
- [Chapter 4.2.6, "TDD frame structure settings"](#), on page 100
- [Chapter 6.2, "SC-FDMA time plan"](#), on page 485
- [Chapter 6.3, "TDD time plan"](#), on page 486.

2.2.2.2 Uplink data transmission

In uplink, data is allocated in multiples of one resource block. Uplink resource block size in the frequency domain is 12 subcarriers, i.e. the same as in downlink. To simplify the DFT design in uplink signal processing only factors 2, 3, and 5 are allowed.

The uplink transmission time interval (TTI) is 1 ms (same as downlink).

User data is carried on the physical uplink shared channel (**PUSCH**).

Related settings

See:

- [Chapter 4.6.7, "PUSCH structure"](#), on page 239
- [Chapter 4.8.4, "Physical uplink shared channel \(PUSCH\)"](#), on page 261
- [Chapter 4.9, "Enhanced PUSCH settings"](#), on page 311

2.2.2.3 Uplink control information transmission

According to the LTE specifications, one of the following channels carries the uplink control information depending on whether an uplink resource has been assigned to the UE or not:

- Physical Uplink Shared Channel (PUSCH)
- Physical Uplink Control Channel (PUCCH)

Control information (CQI reports and ACK/NACK information related to data packets received in the downlink) is multiplexed with the PUSCH, if the UE has been granted with UL-SCH transmission.

The PUCCH carries uplink control information, e.g. CQI reports, HARQ ACK/NACK information, or scheduling requests (SR), in case the UE has not been assigned an UL-SCH transmission. The PUCCH is transmitted on a reserved frequency region at the edges of the total available UL bandwidth. One PUCCH resource comprises a pair of resource blocks within slot 0 and 1 that are located in the upper and the lower part of the spectrum. PUCCH is allocated as shown on the [Figure 2-18 \[TS 36.211\]](#).

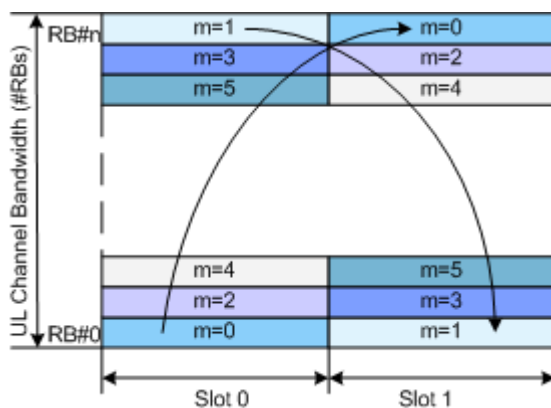

Figure 2-18: PUCCH mapping

TS 36.211 specifies seven PUCCH formats, see [Table 2-4](#).

Table 2-4: PUCCH formats

PUCCH format	Description	Physical bits	Modulation scheme	ODFM symbols used for DMRS (normal CP)	ODFM symbols used for DMRS (extended CP)
1	Scheduling request (SR)	0	-	2, 3, 4	2, 3
1a	ACK/NACK ACK/NACK + SR	1	BPSK	2, 3, 4	2, 3
1b	ACK/NACK for MIMO ACK/NACK + SR	2 4	QPSK	2, 3, 4	2, 3
2	CQI CSI + ACK/ NACK	20	QPSK	1, 5	3
2a	CSI + ACK/ NACK	21	QPSK+BPSK	1, 5	-
2b	CSI + ACK/ NACK for MIMO	22	QPSK+QPSK	1, 5	-
3 ^{*)}	ACK/NACK (if DL carrier aggregation with more than 2 cells) ACK/NACK + SR	48	QPSK	1, 5	3
4 and 5	ACK/NACK (if DL carrier aggregation with more than 5 cell)	Depends on RB size (number of used subcarriers and for F4 also number of RBs), CP and PUCCH format	QPSK	3	2

^{*)} eMTC does not support PUCCH formats 3, 4 and 5

The different PUCCH formats are mapped to the reserved PUCCH region. The mapping is performed so that there can be only one resource block per slot that supports a combination of PUCCH formats 1/1a/1b and 2/2a/2b.

For simultaneous transmission of multiple users on the PUCCH, different PUCCH resource indices are used. Multiple UEs are distinguished within one resource block by using different cyclic shifts (CS) of the CAZAC (constant amplitude zero auto-correlation) sequence. For PUCCH formats 1/1a/1b, three different orthogonal cover sequences (OC) can also be used. For the different PUCCH formats, different number of PUCCH resource indices are available within a resource block (see Table 2-5). The actual number of the used orthogonal sequences is also determined by the parameter `delta_shift`, used to support working in different channel conditions.

Table 2-5: PUCCH resource indices per PUCCH format

PUCCH format	PUCCH resource indices	Number available within a resource block
1/1a/1b	N(1)_PUCCH	36 for normal CP 24 for extended CP
2/2a/2b	N(2)_PUCCH	12
3 ^{*)}	N(3)_PUCCH	5
4 ^{*)}	N(4)_PUCCH	1
5 ^{*)}	N(5)_PUCCH	3

^{*)} eMTC does not support PUCCH formats 3, 4 and 5

Related settings

See:

- [Chapter 4.6.8, "PUCCH structure"](#), on page 240
- [Chapter 4.10, "Enhanced PUCCH settings"](#), on page 321

2.2.2.4 Uplink reference signal structure

Uplink reference signals are used for two different purposes:

- For channel estimation in the eNodeB receiver to demodulate control and data channels
- To provide channel quality information as a basis for scheduling decisions in the base station.
This purpose is also called channel sounding.

The uplink reference signals are based on CAZAC (constant amplitude zero auto-correlation) sequences.

Sounding reference signals (SRS)

The specification defines two types of sounding reference signals (SRS), periodic SRS and aperiodic SRS. A user equipment (UE) can be configured with both SRS trigger types.

- Periodic SRS occurs at regular time intervals.
It is referred as "trigger type 0" SRS and is known from LTE Rel. 8
- The aperiodic SRS transmission is a single (one-shot) transmission
It is referred as "trigger type 1" SRS and is introduced by LTE Rel. 10.
Aperiodic SRS is triggered by the "SRS Request" flag in one of the DCI formats 0/1A/4/2B/2C/2D.
Triggering aperiodic SRS by using DCI format 0 requires one dedicated SRS set of parameters whereas the triggering by using DCI formats 1A/2A/2B/2C uses a common SRS set. For the triggering by DCI format 4, the specification defines three SRS sets.

Related settings

See:

- Chapter 4.6.5.1, "UL reference signals", on page 234
- Chapter 4.6.5.2, "Cell-specific SRS settings", on page 235
- Chapter 4.8.6, "Sounding reference signal (SRS)", on page 268
- "Aperiodic SRS State" on page 136
- "DCI Format 1A" on page 192

2.2.2.5 Uplink physical layer procedures

For EUTRA, the following uplink physical layer procedures are especially important:

Non-synchronized random access

The random access is used to request initial access, as part of handover, when transiting from idle to connected, or to re-establish uplink synchronization. The structure is shown on Figure 2-19 (taken from TS 36.211).

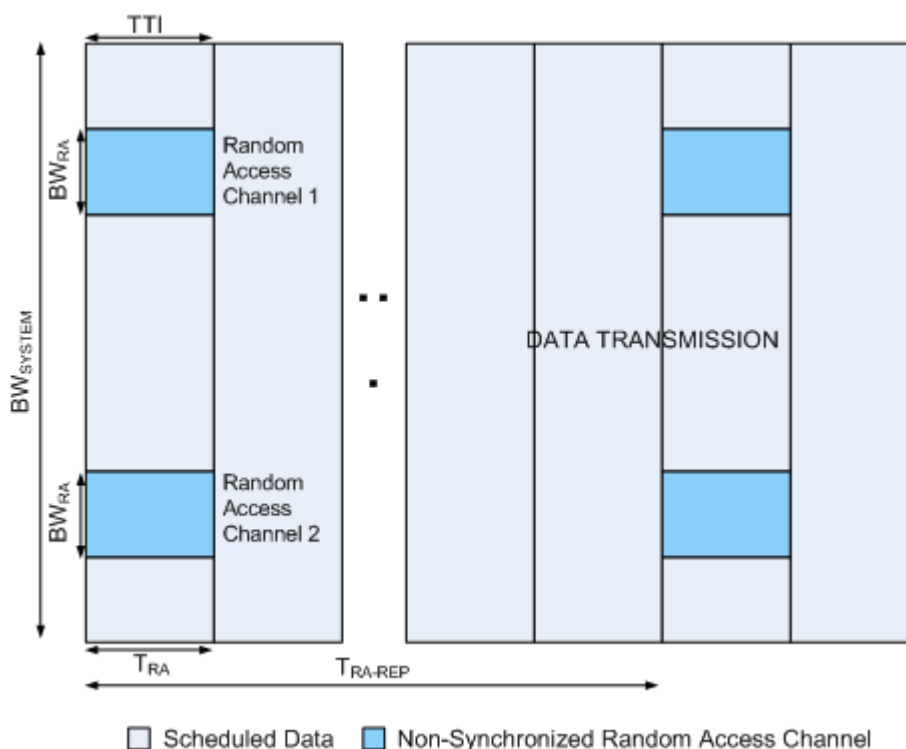

Figure 2-19: Random access structure, principle

Multiple random access channels can be defined in the frequency domain within one access period T_{RA} to provide enough random access opportunities.

For the random access, a preamble is defined as shown on Figure 2-20 (taken from TS 36.211). The preamble length depends on the preamble format. The preamble bandwidth is 1.08 MHz (72 subcarriers). Higher layer signaling controls in which subframes

the preamble transmission is allowed, and the location in the frequency domain. Per cell, there are 64 random access preambles. They are generated from Zadoff-Chu sequences.

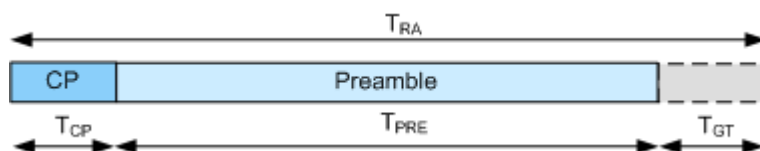

Figure 2-20: Random access preamble

The random access procedure uses open loop power control with power ramping similar to WCDMA. After sending the preamble on a selected random access channel, the UE waits for the random access response message. If no response is detected, then another random access channel is selected and a preamble is sent again.

Related settings

See:

- [Chapter 4.6.6, "PRACH settings"](#), on page 237
- [Chapter 4.8.9, "PRACH power ramping"](#), on page 307
- [Chapter 4.8.10, "PRACH configuration"](#), on page 308

Uplink scheduling

As in the downlink direction, the uplink scheduling is *dynamical scheduling* of uplink resources performed by eNodeB on a subframe basis. The eNodeB assigns certain time/frequency resources to the UEs and informs UEs about transmission formats to use. Scheduling decisions affecting the uplink are communicated to the UEs via the physical downlink control channel (PDCCH) in the downlink. The scheduling decisions can be based on QoS parameters, UE buffer status, uplink channel quality measurements, UE capabilities, UE measurement gaps, etc.

The LTE specification defines a second uplink scheduling method, the *semi-persistent scheduling (SPS)*. The semi-persistent scheduling is used to reduce the control signaling overhead for regularly occurring services and transmissions of relative small payloads. With SPS, the scheduling decisions are not transmitted every subframe but once. Via the PDCCH, the UEs first receive information on the SPS periodicity, that is information about the SPS pattern or the subframes on which scheduling decisions can be transmitted. Semi-persistent scheduling is then activated and deactivated by an explicit trigger, the SPS C-RNTI. The dynamic scheduling commands have higher priority than the SPS.

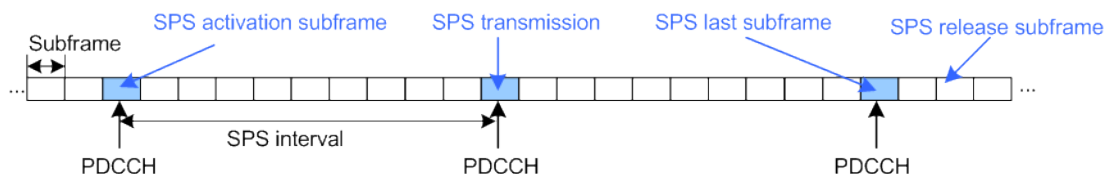

Figure 2-21: Semi-persistent scheduling (SPS)

In carrier aggregation transmission, SPS is allowed only on the primary component carrier.

Related settings

See [Chapter 4.3.7, "SPS configuration settings"](#), on page 153.

Uplink link adaptation

As uplink link adaptation methods, transmission power control, adaptive modulation and channel coding rate, and adaptive transmission bandwidth can be used.

Uplink timing control

Uplink timing control is required to time align the transmissions from different UEs with the receiver window of the eNodeB. The eNodeB sends the appropriate timing-control commands to the UEs in the downlink, commanding them to adapt their respective transmit timing.

Hybrid automatic repeat request (ARQ)

The eNodeB uses the uplink hybrid ARQ protocol to request retransmissions of incorrectly received data packets.

2.2.3 LTE MIMO concepts

Multiple Input Multiple Output (MIMO) systems form an essential part of LTE to achieve the ambitious requirements for throughput and spectral efficiency. MIMO refers to the use of multiple antennas at the transmitter and at the receiver.

2.2.3.1 Downlink MIMO

For the LTE downlink, a 2x2 configuration for MIMO is assumed as baseline configuration, i.e. two transmit antennas at the base station and two receive antennas at the terminal. Configurations with four or more antennas are also being considered.

Different MIMO modes are envisaged. It has to be differentiated between spatial multiplexing and transmit diversity, and it depends on the channel condition which scheme to select.

Related settings

See:

- [Chapter 4.2.8, "Antenna ports settings"](#), on page 125
- [Chapter 4.4.1, "Precoding settings"](#), on page 203
- [Chapter 4.5, "DL antenna port mapping settings"](#), on page 213.

Spatial multiplexing

Spatial multiplexing allows transmitting different streams of data simultaneously on the same downlink resource blocks (see [Figure 2-22](#) for illustration of the principle). These

data streams can belong to one single user (single user MIMO / SU-MIMO) or to different users (multi-user MIMO / MU-MIMO). While SU-MIMO increases the data rate of one user, MU-MIMO allows increasing the overall capacity.

Spatial multiplexing is only possible if the mobile radio channel allows it.

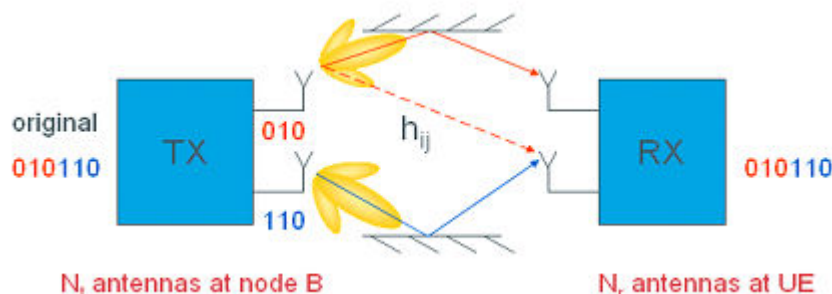

Figure 2-22: Spatial multiplexing

In the Figure 2-22, each transmit antenna transmits a different data stream. Each Rx antenna receives the data streams from all transmit antennas. The channel (for a specific delay) can thus be described by the following channel matrix H:

$$\mathbf{H} = \begin{matrix} & \begin{matrix} \xrightarrow{N_t} \\ \left[\begin{array}{cccc} h_{11} & h_{12} & \dots & h_{1N_t} \\ h_{21} & h_{22} & & h_{2N_t} \\ \vdots & & \ddots & \vdots \\ h_{N_r1} & h_{N_r2} & \dots & h_{N_rN_t} \end{array} \right] \end{matrix} \\ \left[\begin{array}{c} h_{11} \\ h_{21} \\ \vdots \\ h_{N_r1} \end{array} \right] & \begin{matrix} \\ \\ \\ \end{matrix} \\ \end{matrix} \begin{matrix} \\ \\ \\ \end{matrix} \xrightarrow{N_r}$$

In this general description, N_t is the number of transmit antennas, N_r is the number of receive antennas, resulting in a $N_r \times N_t$ matrix for the baseline LTE scenario. The coefficients h_{ij} of this matrix are called channel coefficients from transmit antenna j to receive antenna i , thus describing all possible paths between the transmitter and the receiver.

The number of data streams that can be transmitted in parallel over the MIMO channel is given by $\min \{N_t, N_r\}$. It is limited by the rank of the matrix H. The transmission quality degrades significantly in case the singular values of matrix H are not sufficiently strong. This can happen in case the two antennas are not sufficiently de-correlated, for example in an environment with little scattering or when antennas are too closely spaced.

Codewords and spatial layers

A block of information bits that can be separately processed before it is transmitted in a subframe, is called codeword [17].

A spatial layer indicates the number of spatial streams that can be simultaneously transmitted [17]. The number of layers for transmission is less than or equal to the number of transmit antenna ports and depends on the rank of the matrix H.

In LTE Rel. 8/9, up to two codewords can be transmitted simultaneously and mapped onto up to four layers. There is a fixed mapping between codewords to layers, see Figure 2-23.

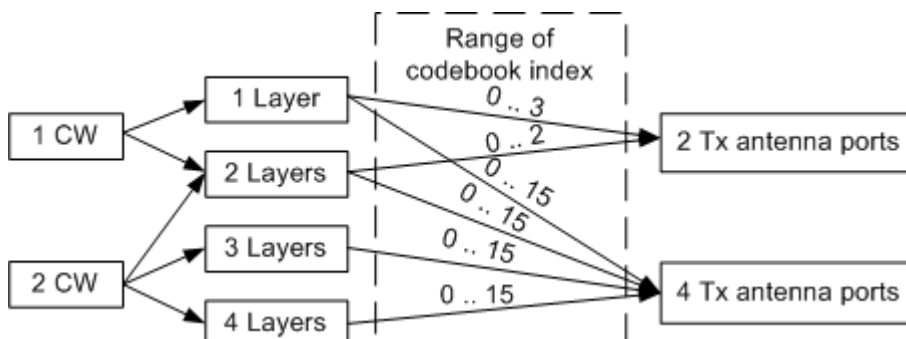

Figure 2-23: Codeword to layer mapping for downlink spatial multiplexing (LTE Rel. 8/9)

Precoding

Precoding on transmitter side is used to support spatial multiplexing, see Figure 2-24 (from TS 36.211). This is achieved by applying a precoding matrix W to the signal before transmission.

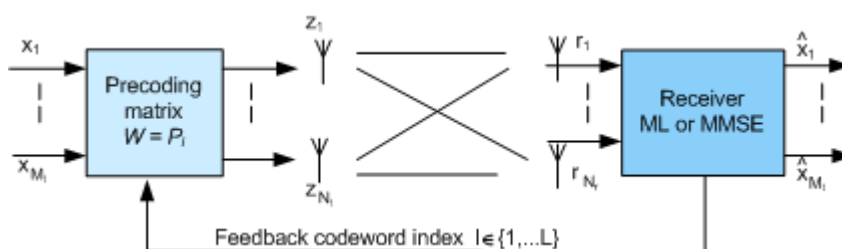

Figure 2-24: Precoding principle

The optimum precoding matrix W is selected from a predefined "codebook" which is known at the eNodeB and at the UE. Unitary precoding is used, i.e. the precoding matrices are unitary: $W^H W = I$. The UE estimates the radio channel and selects the optimum precoding matrix. The optimum precoding matrix is the one which offers maximum capacity. The UE provides feedback on the uplink control channel regarding the preferred precoding matrix (precoding vector as a special case). Ideally, this information is made available per resource block or at least group of resource blocks, since the optimum precoding matrix varies between resource blocks. The Figure 2-25 (from TS 36.211) gives an overview of EUTRA downlink baseband signal generation including the steps relevant for MIMO transmission.

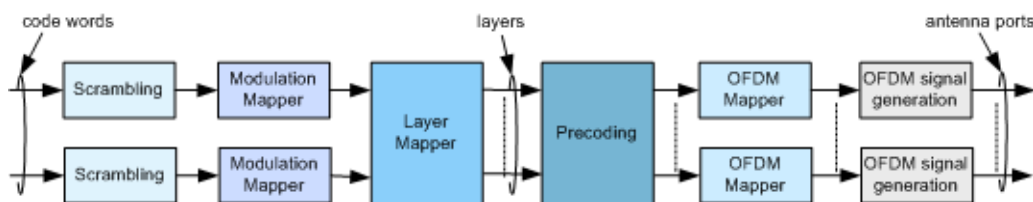

Figure 2-25: Overview of downlink baseband signal generation

Transmission modes

LTE defines the following transmission modes for the PDSCH (TS 36.213).

Table 2-6: Downlink transmission modes overview

Transmission mode	Transmission scheme
Tx Mode 1	Single-antenna transmission (AP 0); SISO/SIMO but no MIMO
Tx Mode 2	Transmit diversity
Tx Mode 3	<ul style="list-style-type: none"> • Transmit diversity • Open-loop spatial multiplexing with large delay CDD; SU-MIMO (single user MIMO)
Tx Mode 4	<ul style="list-style-type: none"> • Transmit diversity • Closed-loop spatial multiplexing; SU-MIMO
Tx Mode 5	<ul style="list-style-type: none"> • Transmit diversity • MU-MIMO (multi-user MIMO)
Tx Mode 6	<ul style="list-style-type: none"> • Transmit diversity • Closed-loop spatial multiplexing using a single transmission layer
Tx Mode 7	Single-antenna port transmission (AP 5); single layer beamforming
Tx Mode 8	<ul style="list-style-type: none"> • Dual layer transmission (AP 7 and AP 8); dual layer beamforming • Single-antenna port (AP 7 or AP 8)
Tx Mode 9	Multi-layer transmission (AP 9 to AP 14); MU-MIMO, SU-MIMO, 8 layer beamforming
Tx Mode 10	Multi-layer transmission (AP 9 to AP 14), CoMP (coordinated multi-point operation)

See also "[Mapping of reference signals to antenna ports](#)" on page 25.

Transmit diversity

Instead of increasing data rate or capacity, MIMO can be used to exploit diversity. If the channel conditions do not allow spatial multiplexing, a transmit diversity scheme is used instead, so switching between these two MIMO modes is possible depending on channel conditions. Transmit diversity is used when the selected number of streams (rank) is one.

Beamforming

The beamforming is a method to shape the transmitted signal in the receiver's direction. In LTE, the beamforming is defined as transmission mode 7, 8 and 9 (Tx Mode 7/8/9). Beamforming uses the special antenna ports 5 and 7 to 14, see [Table 2-6](#).

The channel estimation in a beamforming scenario is based on the [UE-specific reference signal \(DMRS\)](#).

2.2.3.2 Uplink MIMO

Uplink MIMO schemes for LTE differ from downlink MIMO schemes. Up to LTE Rel. 9, only uplink MU-MIMO is specified. Multiple user terminals can transmit simultaneously on the same resource block. This is also referred to as spatial domain multiple access

(SDMA). The scheme requires only one transmit antenna at the UE. The UEs sharing resource blocks have to apply mutually orthogonal pilot patterns.

For information on the SU-MIMO and the LTE-Advanced MIMO concept, see [Chapter 2.2.5.3, "Enhanced MIMO schemes"](#), on page 47.

2.2.4 LTE MBMS concepts

In LTE, MBMS transmission is performed as single-cell transmission or as multi-cell transmission. In multi-cell transmission, the cells and content are synchronized to enable for the terminal to soft-combine the energy from multiple transmissions. The superimposed signal looks like multipath to the terminal. This concept is also known as single frequency network (SFN). The EUTRAN can configure which cells are part of an SFN for transmission of an MBMS service. The MBMS traffic can share carrier with the unicast traffic or be sent on a separate carrier. For MBMS traffic, an extended cyclic prefix is provided. Specific reference signals are used in the subframes that carry MBMS SFN data (see ["MBSFN reference signals"](#) on page 28).

MBMS data is carried on the MBMS traffic channel (MTCH) as logical channel. The MBMS control channel MCCH carries the MBMS control information. Both logical channels, the MTCH and the MCCH, are mapped onto the physical multicast channel PMCH in the multi-cell transmission case. If a single-cell transmission is used, they are mapped on the PDSCH.

Related settings

See [Chapter 4.2.3, "MBSFN settings"](#), on page 78.

2.2.5 LTE Release 10 (LTE-Advanced) introduction



This description gives a brief description only of the LTE-A features currently covered by the software option R&S SMM-K85. The full set of LTE-Advanced features is described in [1MA232](#).

For a complete LTE-Advanced technology introduction and an insight description of the LTE-A features, refer to:

- White Paper [1MA169](#) "LTE-Advanced Technology Introduction"
- Application Note [1MA166](#) "LTE-Advanced Signals Generation and –Analysis"

2.2.5.1 Carrier aggregation

The LTE-A Rel. 10 specification uses the aggregation of multiple LTE carriers. Two or more component carriers (CC) are grouped to support wider transmission bandwidths of up to 100 MHz. To an LTE Rel. 8 terminal, each component carrier appears as an LTE carrier. An LTE Rel. 10 terminal can exploit the total aggregated bandwidth. As backward compatibility is fulfilled, a LTE-Advanced cell can serve both LTE Rel. 8 and LTE Rel. 10 terminals simultaneously.

Spectrum deployment can be either contiguous with adjacent component carriers, or non-contiguous with non-adjacent component carriers (see Figure 2-26, 1MA169). The individual component carriers can belong to the same frequency band (intra-band) or to different frequency bands (inter-band). Component carriers transmitted by the same eNodeB provide the same cell coverage.

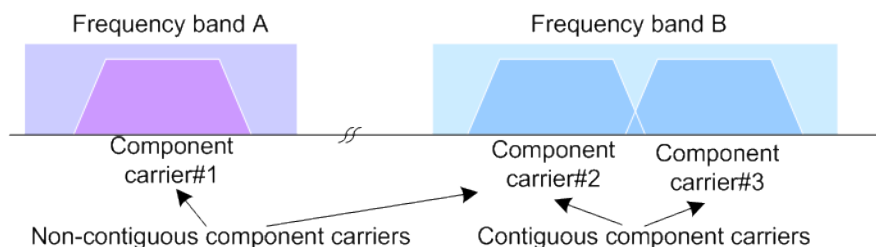

Figure 2-26: Carrier aggregation

The LTE-A specification defines two different approaches about informing the UE about the scheduling for each band: a separate PDCCH for each carrier or a common PDCCH for multiple carriers (cross-carrier scheduling).

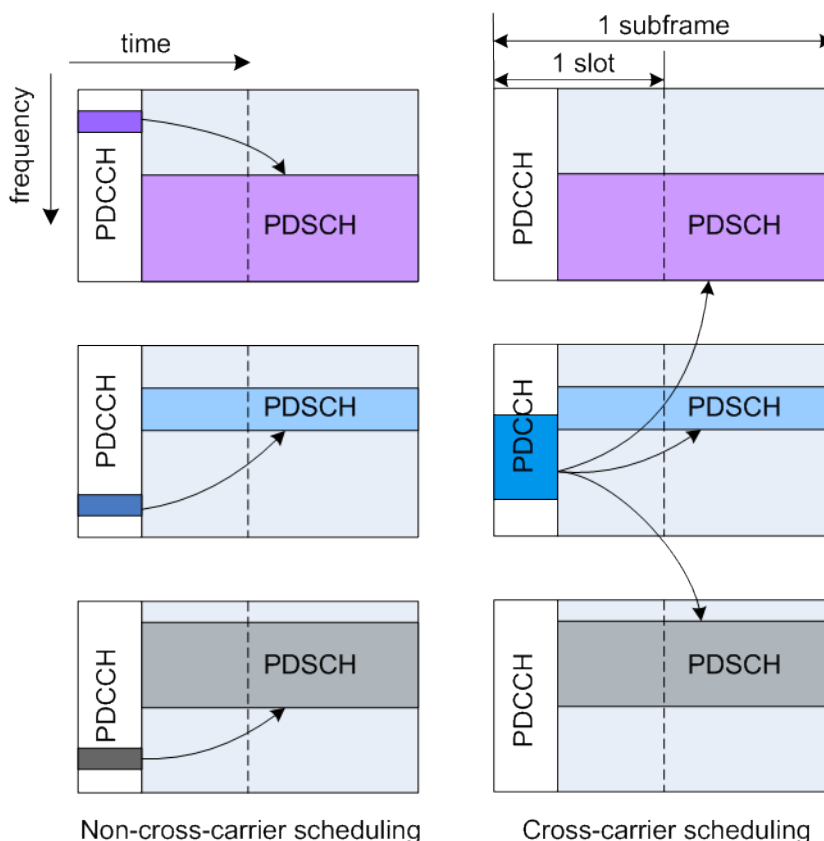

Figure 2-27: LTE-A scheduling approaches

In the dedicated/non-cross-carrier approach, the PDCCH on a component carrier assigns PDSCH resources on the same component carrier. The used PDCCH structure is identical to the LTE Rel. 8/9 PDCCH structure.

In the cross-carrier approach, the PDCCH on a component carrier assigns resources on one of multiple component carriers. The component carriers are identified by the new introduced DCI field, the CIF (carrier indicator field).

Related settings

See:

- [Chapter 4.2.2, "DL carrier aggregation configuration"](#), on page 70.
- [Chapter 4.3, "DL frame configuration settings"](#), on page 127.
- [Chapter 4.3.3, "User configuration settings"](#), on page 130.

2.2.5.2 Enhanced uplink SC-FDMA

The LTE-A Rel. 10 enhances the uplink transmission scheme compared to the LTE Rel. 8 uplink with the following:

- **Control-data decoupling**
In LTE Rel. 8/9, a UE only uses physical uplink control channel (PUCCH) when it does not have any data to transmit on PUSCH. If a UE has data to transmit on PUSCH, it would multiplex the control information with data on PUSCH. This behavior is not valid in LTE-Advanced, which means that simultaneous PUCCH and PUSCH transmission is possible in uplink direction.
- **Non-contiguous data transmission**
LTE-Advanced extends the uplink transmission scheme by allowing clustered PUSCH. The uplink transmission is not restricted to the use of consecutive subcarriers. Clusters of resource blocks can be allocated (two "sets" of consecutive PUSCH resource block groups according to resource allocation type 1 as defined in [TS 36.213](#)).

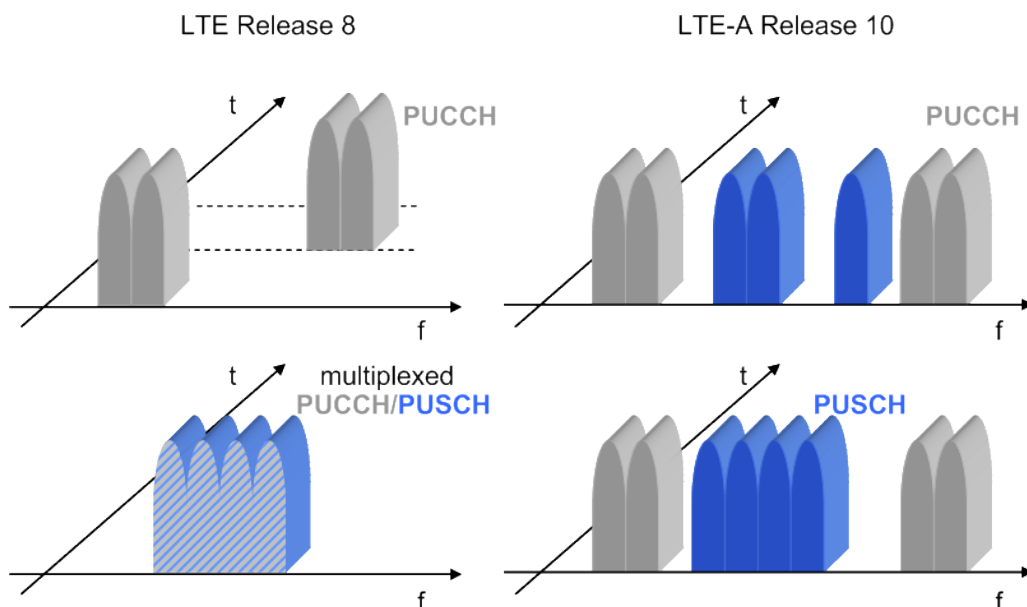

Figure 2-28: LTE Release 8 and LTE-A Release 10 UL transmission schemes

Related settings

See:

- [Chapter 4.7, "UL frame configuration settings"](#), on page 243
- [Chapter 4.8, "User equipment configuration"](#), on page 253.

2.2.5.3 Enhanced MIMO schemes

LTE Rel. 8 supports MIMO schemes in downlink direction. In downlink direction, up to four transmit antennas can be used whereas the maximum number of codewords is two irrespective of the number of antenna ports. LTE-Advanced extends the MIMO capabilities of LTE Rel. 8/9 to now supporting eight downlink antennas (8x8 antenna configuration) and four uplink antennas (4x4 antenna configuration), see [Figure 2-29](#), and [Figure 2-30](#), 1MA169.

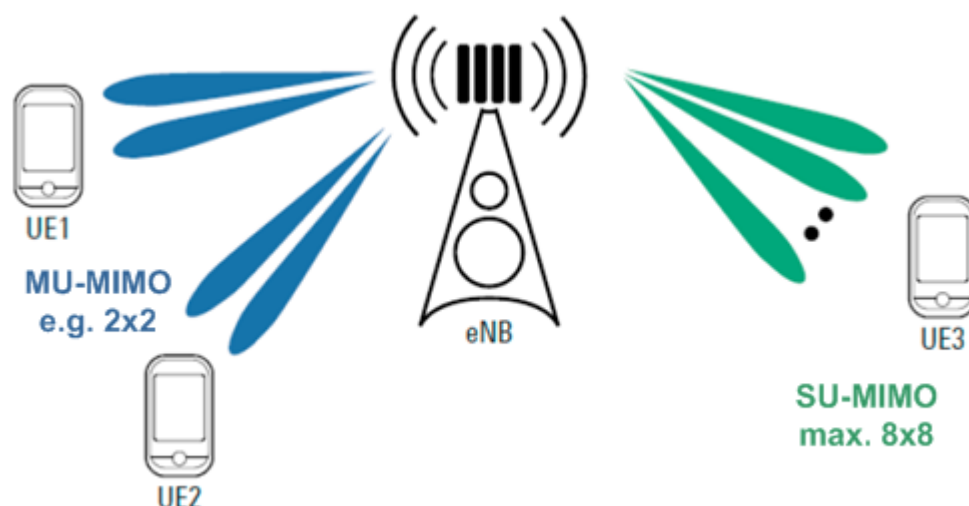

Figure 2-29: Supported transmit layers in LTE-Advanced (downlink)

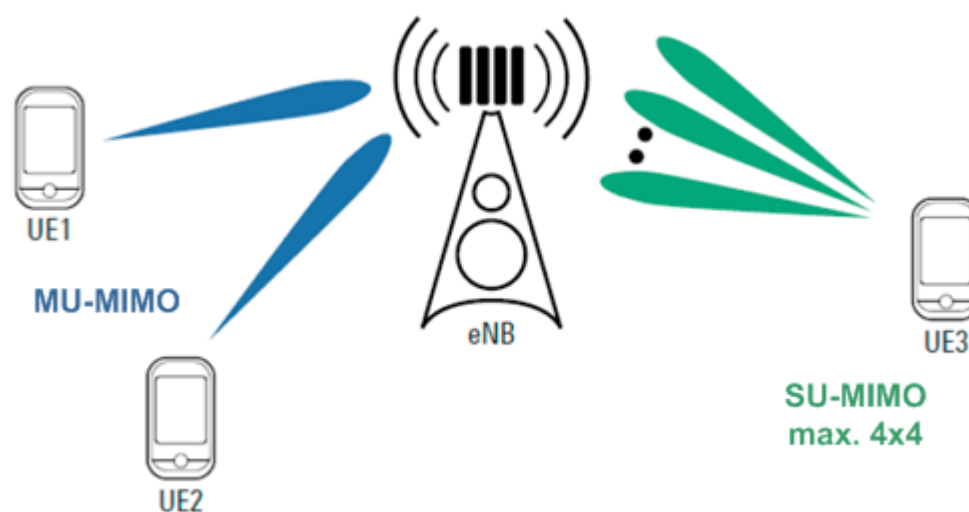

Figure 2-30: Supported transmit layers in LTE-Advanced (uplink)

In addition to the spatial multiplexing schemes, transmit diversity is possible in both downlink and uplink direction.

Downlink MIMO

The following is a list of the main differences compared to LTE Rel. 8/9:

- Layer mapping for downlink spatial multiplexing that uses the AP 7 to AP 14 for up to 8 layer PDSCH
See "Mapping of reference signals to antenna ports" on page 25 and [Figure 2-23](#)
- Scheduling of downlink resources uses the DCI format 2C and transmission mode 9 (TM9)
See "Transmission modes" on page 43
- Introduced are the PDSCH demodulation reference signals DMRS
See "UE-specific reference signal (DMRS)" on page 29
- Channel state estimation reference signals (CSI-RS)
See "CSI reference signals" on page 31

Uplink MIMO

The following is a list of the main difference compared to LTE Rel. 8/9:

- PUSCH transmission uses up to two codewords, up to four layers and up to four antenna ports to support SU-MIMO
- If two PUSCH codewords are used, these codewords can use different modulation schemes
- Defined are different codebooks depending on the used number of antenna ports and layers

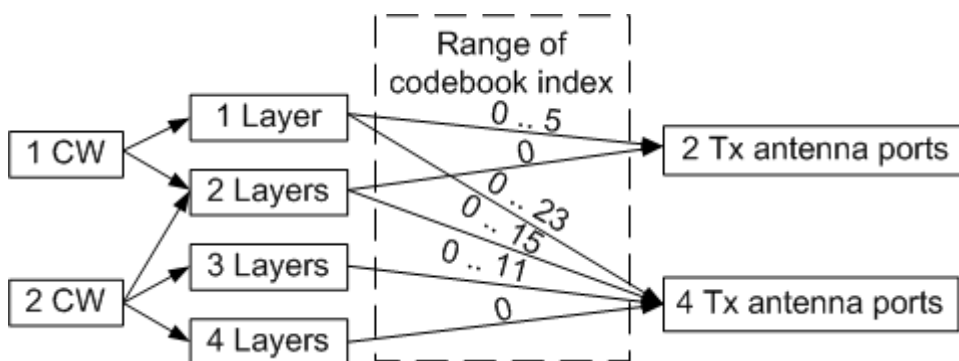

Figure 2-31: Codeword to layer mapping for uplink spatial multiplexing (LTE Rel. 10)

- PUCCH can be transmitted on up to two antenna ports
- SRS can be transmitted on up to four antenna ports

See [Table 2-7](#)

Table 2-7: Uplink transmission modes overview

Transmission mode	Transmission scheme
Tx Mode 1	No spatial multiplexing; transmission on a single antenna port
Tx Mode 2	Spatial multiplexing

Related settings

See:

- [Chapter 4.7.3, "UL allocation table"](#), on page 248
- [Chapter 4.8.2, "Physical uplink control channel \(PUCCH\)"](#), on page 256, [Chapter 4.8.4, "Physical uplink shared channel \(PUSCH\)"](#), on page 261, [Chapter 4.8.5, "Demodulation reference signal \(DMRS\)"](#), on page 266, [Chapter 4.8.6, "Sounding reference signal \(SRS\)"](#), on page 268 and [Chapter 4.8.8, "Antenna port mapping"](#), on page 304
- [Chapter 4.9, "Enhanced PUSCH settings"](#), on page 311
- [Chapter 4.10, "Enhanced PUCCH settings"](#), on page 321

2.2.6 LTE Release 11 introduction



This section gives a brief description only of the LTE-A Rel. 11 features currently covered by the software option R&S SMM-K112.

For a complete LTE-Advanced (3GPP Rel. 11) technology introduction and an insight description of the LTE-A features, refer to:

- White Paper [1MA232](#) "LTE-Advanced (3GPP Rel. 11) Technology Introduction"

LTE carrier aggregation enhancements

LTE-Advanced 3GPP Rel. 11 introduces the following new features:

- Multiple timing advances (TA) for uplink carrier aggregation
- Non-contiguous intra-band carrier aggregation
- Two special subframe configurations for LTE TDD
 - Special subframe configuration 9 with normal cyclic prefix in downlink
 - Special subframe configuration 7 with extended cyclic prefix in downlink
- Support of different UL/DL configurations on different bands
If TDD carrier aggregation is used, the individual carriers can use different UL/DL configurations
- Enhanced TxD schemes for PUCCH format 1b with channel selection

New control channel: enhanced PDCCH (EPDCCH)

LTE-Advanced 3GPP Rel. 11 introduces the new downlink control channel to support new features and to increase the control channel capacity.

The enhanced physical downlink control channel (EPDCCH) carries the downlink control information. Compared to the PDCCH, the EPDCCH is not allocated on the first symbols of a subframe as it is with PDCCH but uses resource blocks normally reserved for the PDSCH.

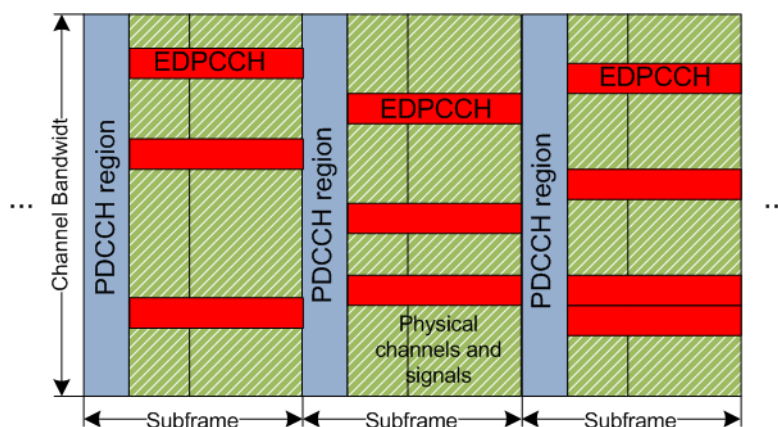

EPDCCH is a user-specific control channel. It is always transmitted in an EPDCCH set. For each component carrier and user, you can define one or two EPDCCH sets. Each EPDCCH set consists of 2, 4 or 8 physical resource block (PRB) pairs that do not have to be contiguous in frequency.

Each PRB pair consists of a number of enhanced control channel elements (ECCE). Each ECCE consists of 4 or 8 enhanced resource element groups (EREG), where there are 16 EREG per PRB pair. If the subsequent EREGs are allocated within a single PRB pair, the EPDCCH transmission is referred as localized. Opposite, if the EREGs are distributed over several PRB pairs, the transmission is referred as distributed. The two different transmission schemes can be used depending on the availability of reliable channel feedback and knowledge about the channel state conditions. Distributed transmission for instance can be used to exploit frequency diversity.

DMRSs associated with EPDCCH are transmitted on antenna ports AP 107 to AP 110. In the resource blocks mapping grid, these APs replace the AP 7 to AP 10 used for DMRS. See also [Figure 2-13](#).

DMRSs for EPDCCH are scrambled with higher layer user-specific identifier $n_{ID,m}^{EPDCCH}$, where $m = 0$ or 1 and indicates the EPDCCH set.

Related settings

See:

- [Chapter 4.3.5, "EPDCCH configuration settings"](#), on page 147
- ["\(E\)PDCCH"](#) on page 186
- [DCI Format 2/2A/2B/2C/2D](#) > "HARQ-ACK Resource Offset"

Coordinated multi-point operation for LTE (CoMP)

CoMP is a new interference mitigation technique that aims to improve coverage of high data rates and increase cell-edge throughput. CoMP also aims to optimize the transmission and reception from multiple transmission points (TP). A TP is a term that describes the location, where the transmission physical occurs. TPs can be the sectors on the same site, different remote radio heads (RRH), or different cells for example.

In CoMP scenarios, a UE can receive signals from up to 3 transmission points (TP). During reception, the UE is unaware which of the TP is transmitting. All TPs transmit-

ting to a particular UE can use the same scrambling sequence for generation of the user-specific reference signals (DMRS). The same applies for the cell-specific reference signals (CSI-RS).

According to [TS 36.211](#), the CSI-RS sequence is generated as a function of the variable N_{ID}^{CSI} , where $N_{ID}^{CSI} = N_{ID}^{cell}$ unless configured by higher layers. The CSI-RS sequence can be initialized with the cell identity as it is in the legacy systems and if CoMP is used, it can be initialized with "virtual cell ID". The latter is introduced to support measurements from different TPs.

According to [TS 36.211](#), the demodulation reference signals (DMRS) for PDSCH are generated as a function of the variable n_{ID} and n_{SCID} .

- Up to LTE Rel. 11, the $n_{ID} = N_{ID}^{cell}$.
The DMRS sequence is initialized with the physical cell identity (PCI) N_{ID}^{cell} .
- In LTE Rel. 11, the following applies:
 - $n_{ID} = N_{ID}^{cell}$ or
 - If signaled by the DCI or higher-level, $n_{ID} = n_{ID}^{DMRS,i}$
Where $i = 0, 1$ and $n_{ID}^{DMRS,i}$ are two DMRS scrambling identity.
- The n_{SCID} is the scrambling identity and it is $n_{SCID} = 0$ or given by the corresponding field of DCI format 2B, 2C or 2D.

Related settings

See:

- [Chapter 4.3.6, "Scrambling configuration settings"](#), on page 152
- ["DCI Format 2/2A/2B/2C/2D"](#) on page 199
 - DCI format 2C and 2D: "Ant. Port(s), Layers, SCID"
 - DCI format 2B: "Scrambling Identity"
- ["Scrambling Identity \$n_{SCID}\$ "](#) on page 206

Transmission mode TM10 and DCI format 2D

The TM10 is intended for multi-layer PDSCH transmission with up to eight layers and in case of coordinated multi-point operation (CoMP).

The transmission mode TM10 is similar to the transmission mode TM9. It uses DCI format 2D that serves the same purpose as the DCI format 2C does for the TM9. Both formats carry the same information fields but the DCI format 2D comprises four additional bits. The first two indicate one of four pre-configured sets of parameters and are related to the rate matching information and the QCL (quasi-co-located) indicator.

Related settings

See:

- ["Tx Modes"](#) on page 133
- ["Transmission Scheme"](#) on page 204
- ["DCI Format"](#) on page 186
- ["DCI Format 2/2A/2B/2C/2D"](#) on page 199

2.2.7 LTE Release 12 introduction



This section gives a brief description only of the LTE-A Rel. 12 features that are covered by the software option R&S SMM-K113.

For a complete LTE-Advanced (3GPP Rel. 12) technology introduction and an insight description of the LTE-A features, refer to:

- White Paper [1MA252](#) "LTE-Advanced (3GPP Rel. 12) Technology Introduction"

Higher-order modulation (256QAM)

[TS 36.213](#) adds a modulation and coding scheme index table to allow signaling of the 256QAM modulation. The new modulation and coding scheme index table is referred to as MSC table 2.

Related settings

See:

- "DL Frame Configuration" > "User Configuration" > [MSC Table](#)
- "MBFSN" > [Use Table 2](#) and [Modulation](#)
- "DL Frame Configuration" > "Subframe" > [Modulation](#)
- "DL Frame Configuration" > "Dummy Data Configuration" > [Modulation](#)

LTE TDD-FDD joint operation including carrier aggregation

Combination of component carriers with TDD and FDD duplexing in both the downlink and in the uplink, including independent UL/DL configuration per component carrier.

See:

- "General UL Settings" > "CA" > [Duplexing](#)
- "General DL Settings" > "CA" > [Duplexing](#)

Enhanced interference mitigation & traffic adaption (eIMTA)

eIMTA (enhanced interference mitigation & traffic adaptation) is an enhancement to LTE TDD for UL-DL interference and load management. This feature is also known as dynamic or flexible TDD.

If eIMTA is used, an eNodeB can change the TDD pattern ([TDD UL/DL Configuration](#)) on a frame basis and adapt the frame structure to the traffic. That is, an eNodeB can decide to reconfigure a subset of the UL and special subframes to DL subframes. LTE-Advanced UEs that support eIMTA can receive DL transmissions in these subframes. An eNodeB does not send an UL DCI to legacy UEs for these subframes, so that legacy UEs cannot schedule UL transmissions in these subframes.

The following layer 1 parameters are supported:

- Dedicated eIMTA-RNTI used for CRC scrambling of the PDCCH
See "DL Frame Configuration" > "User Configuration" > [eIMTA-RNTI](#)
- Modified DCI format 1C that indicates the UL/DL configuration numbers (1, 2, ...1).

Each UL/DL configuration number consist of 3 bits and corresponds to one of the UL/DL configurations (see [Figure 2-5](#)). Each UL/DL configuration is applied for a specific number of frames, where the number of frames is signaled by higher levels.

See "DL Frame Configuration" > "PDCCH" > "DCI Table" > [DCI Format 1C for eIMTA](#).

According to [TS 36.212](#), further parameters are set by higher-level signaling.

Further DL MIMO enhancements (enhanced 4Tx codebook)

To achieve better system throughput, Rel. 12 introduces a new enhanced 4Tx codebook as one of the DL MIMO enhancements.

The enhanced 4Tx codebook is specified in [TS 36.213](#).

[Figure 2-32](#) shows an example of the single-layer case. For reference information on all codebooks, see [TS 36.213](#).

i_1	i_2							
	0	1	2	3	4	5	6	7
0	$W_{i_1,0}^{(1)}$	$W_{i_1,8}^{(1)}$	$W_{i_1,16}^{(1)}$	$W_{i_1,24}^{(1)}$	$W_{i_1+8,2}^{(1)}$	$W_{i_1+8,10}^{(1)}$	$W_{i_1+8,18}^{(1)}$	$W_{i_1+8,26}^{(1)}$
1								
5								
i_1	i_2							
	8	9	10	11	12	13	14	15
0	$W_{i_1+16,4}^{(1)}$	$W_{i_1+16,12}^{(1)}$	$W_{i_1+16,20}^{(1)}$	$W_{i_1+16,28}^{(1)}$	$W_{i_1+24,6}^{(1)}$	$W_{i_1+24,14}^{(1)}$	$W_{i_1+24,22}^{(1)}$	$W_{i_1+24,30}^{(1)}$
1								
5								
where $W_{m,n}^{(1)} = \frac{1}{2} \begin{bmatrix} \mathbf{v}'_m \\ \phi'_n \mathbf{v}'_m \end{bmatrix}$								

Figure 2-32: Codebook for 1-layer CSI reporting [1MA252, TS 36.213]

See:

- ["Use Alternative Codebooks"](#) on page 218
- ["Use Alternative Codebooks"](#) on page 206

2.2.8 LTE Release 13/14 introduction

This section gives a brief introduction only of the LTE-A Rel. 13 features that are covered by the software option R&S SMM-K119.

For technical details, refer to the 3GPP Rel. 13 specifications [TS 36.211](#), [TS 36.212](#) and [TS 36.213](#).

Up to LTE Rel. 12, all LTE networks use licensed spectrum bands. LTE Rel. 13 adds among others the downlink LAA (license assisted access) functionality. It enhances the carrier aggregation concept to use the unlicensed 5 GHz spectrum of the ISM (industrial, scientific and medical) band.

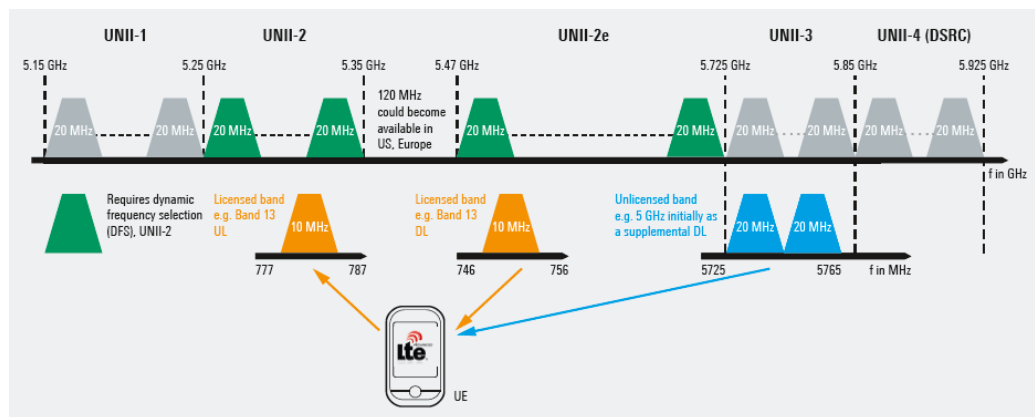

Figure 2-33: Carrier aggregation of licensed and unlicensed spectra [Rohde & Schwarz poster "Evolution of Carrier Aggregation (3GPP Releases 10 to 13)"]

Mechanisms for spectrum sharing

Since the unlicensed spectrum has to be shared fairly, LTE is extended to include the following mechanisms:

- Clear channel assessment (CAA) based on listen-before-talk (LBT) functionality
- Discontinuous transmission (DTX) on a carrier with maximum channel occupancy time (MCOT)
- Dynamic frequency selection (DFS) for radar avoidance in certain bands

LAA SCells

Foreseen is a carrier aggregation of up to five component carriers, where the PCell must be within the licensed spectrum. Up to four component carriers (SCells) can use unlicensed frequency bands and span a 20 MHz channel bandwidth. Each component carrier can use a 2x2 MIMO operation. LAA SCells support only downlink operation by using frame structure type 3 with normal cyclic prefix (CP). LAA SCells do not support transmission modes 5, 6 and 7 for PDSCH.

Related settings

See:

- "General DL Settings > Carrier Aggregation" > [Duplexing](#)

2.2.8.1 Frame structure type 3 (LAA) and partial subframes

The frame structure type 3 is applicable for LAA SCells. It allows DL transmission in bursts with burst duration of up to 10 ms, where the 10 ms correspond to the allowed MCOT. Except from the discovery reference signal (DRS), channels cannot be sent outside the bursts.

LAA SCell using frame structure type 3 is always regarded as FDD component carriers. Hence, depending on the duplexing mode the PCell uses, the resulting configuration is FDD only or carrier aggregation with mixed TDD-FDD component carriers.

Radio frames with frame structure type 3 are 10 ms, composed of 20 slots with length of 0.5 ms each. Two consecutive slots build a subframe. Downlink transmission uses one or more consecutive subframes, starting **at the first or seventh symbol** within a subframe and ending with the last subframe. The last subframe can be either fully occupied or following one of the DwPTS durations, specified for frame structure type 2 (see "Frame structure type 2 (TDD)" on page 20).

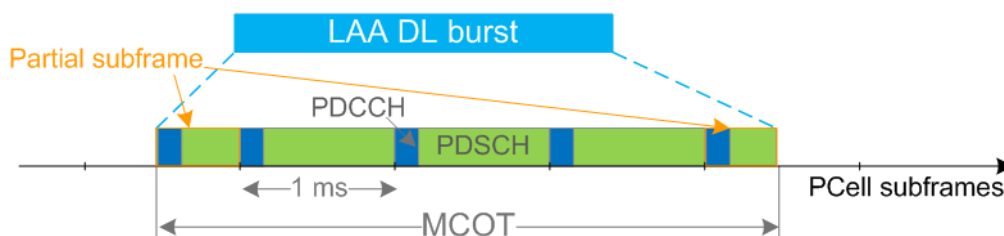

Figure 2-34: DL LAA burst transmission

LAA DL burst	= Example of burst consisting of 3 consecutive and 2 partial subframes
PCell	= LTE primary cell
MCOT	= Maximum channel occupancy time ≤ 10 ms
1 ms	= LTE PCell and LAA SCell slot duration
PDCCH, PDSCH	= Channels are always sent within the bursts
Partial subframe	= Starting at second slot boundary and ending as a DwPTS subframe

Partial subframes

LTE Rel. 13 introduces the concept of partial subframes, where the following applies:

- Starting subframe
LAA DL burst can start at the LTE subframe boundary (`subframeStartPositon`) or at the boundary of the second slot of a subframe (`secondSlotStartingPositon`).
A partial starting subframe is followed by a subframe with all symbols used.
- Ending subframe n
The last subframe of a LAA DL burst can end on the LTE subframe boundary or on a symbol boundary as in DwPTS (`endingDwPTS`).
Thus, the duration of the last subframe of a DL LAA burst can consist of 14 OFDM symbols or of 3, 6, 9, 10, 11 or 12 OFDM symbols. Where the latter corresponds to the Downlink Pilot Time Slot (DwPTS) structure of the TDD frame.
Ending subframe is configured by the dedicated DCI format 1C, see [Chapter 2.2.8.2, "DCI format 1C"](#), on page 55.

Related settings

See:

- "DL Frame Configuration" > [LAA](#)

2.2.8.2 DCI format 1C

DCI format 1C carries the field "Subframe Configuration for LAA" which specifies the number of symbols to be used for transmission.

Assuming n is the last subframe, DCI format 1C can be sent in the following ways:

- **n or $n-1$:**
In the next-to-last subframe ($n-1$) or in the last subframe n .
- **n and $n-1$:**
If present in both, then both subframes have to use identical subframe configuration.
- **n :**
If "Subframe Configuration for LAA < 14", no other physical channels are sent in subframe n

Related settings

See:

- "DL Frame Configuration > (E)PDCCH > DCI Table" > [User](#)
- "DL Frame Configuration > (E)PDCCH > DCI Table > DCI Format = 1C" > [DCI Format 1C for LAA](#)

2.2.8.3 Physical channels and signals in an LAA SCell

LAA SCell supports:

- PDSCH, (E)PDCCH, CRS, CSI-RS and DRS

LAA SCell does not support:

- PHICH, PBCH and PMCH

Discovery reference signal (DRS)

DRS is 1 ms (or 12 OFDM symbols) long and is transmitted at most once in any subframe during periodical occasions referred as DRS measurement timing configuration (DMTC). The DMTC occasions have duration of 6 ms and a configurable period of 40 ms, 80 ms or 160 ms.

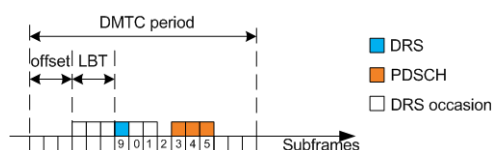

Figure 2-35: DRS allocation

DRS	= Discovery reference signal
LBT	= Listen-before-talk
DMTC	= DRS measurement timing configuration
DRS occasion	= Subframes during the DMTC period where DRS can occur
PDSCH	= Physical DL shared channel

If part of DRS, PSS and SSS are always transmitted, regardless of the subframe where the DRS occasion appears. Simultaneous transmission of DRS and PDSCH/(E)PDCCH is allowed in subframe#0 and subframe#5.

Related settings

See:

- "General DL Settings > Signals" > **"DRS"**
- "General DL Settings > Signals > DRS" > **CSI-RS** > "Config"

2.2.8.4 Full dimension MIMO (FD-MIMO)

Full Dimension MIMO is a MIMO method that employs antennas capable of beam steering in the 3D space. This 3D steering is realized by an antenna system that can form horizontal and vertical beams.

A vertical beam steering allows for focusing on different floor of a multi-story building, whereas horizontal beams facilitates MU-MIMO transmission, as described in [Chapter 2.2.5.3, "Enhanced MIMO schemes"](#), on page 47. Antenna focusing in the vertical axis is also known as elevation beam steering; similarly, the horizontal one is referred to as azimuth beam steering.

Precise 3D beam steering requires measuring and reporting channel state information for each beam separately. The CSI-RS structure specified in the LTE standards up to LTE Rel. 12 is sufficient for the MU-MIMO case but not for the requirements of the 3D MIMO scenarios.

Thus, LTE Rel. 13 extends the specification to include multiple CSI-RS configurations per cell. It also extends the range of supported antenna ports by allowing transmission on AP 23 to AP 46. Moreover, it introduces a CDM scheme to support the mapping to the physical resources.

According to [TS 36.211](#), CSI reference signals are transmitted on 1, 2, 4, 8, 12, 16, 20, 24, 28, or 32 antenna ports. Since there are a total number of 32 antennas and eight different CSI configurations, the specification limits the amount of possible combination by applying an aggregation rule. [Table 2-8](#) lists the possible combinations.

Table 2-8: Aggregation of CSI-RS configurations [TS 36.211]

Total number of antenna ports $N_{\text{res}}^{\text{CSI}} * N_{\text{ports}}^{\text{CSI}}$	Number of antenna ports per CSI-RS configuration $N_{\text{ports}}^{\text{CSI}}$	Number of CSI-RS configurations $N_{\text{res}}^{\text{CSI}}$
12	4	3
16	8	2
20	4	5
24	8	3
28	4	7
32	8	4

Related settings

See:

- [Chapter 4.2.7.4, "CSI-RS settings"](#), on page 108

- [Chapter 4.5, "DL antenna port mapping settings"](#), on page 213

2.2.8.5 PUCCH formats 4 and 5

From LTE Rel. 14 on, the specification is extended with carrier aggregation of up to 32 carriers, both in the downlink and in the uplink direction. For the carrier aggregation in uplink, two new PUCCH formats are defined, PUCCH format 4 and PUCCH format 5.

Carrier aggregation with more than 5 carriers is not supported by the current firmware version, but you can configure the PUCCH formats. Other than in all other PUCCH formats, PUCCH format 4 spans more than one contiguous resource blocks and thus uses larger resource block in the time domain.

For overview information on the PUCCH formats, see [Chapter 2.2.2.3, "Uplink control information transmission"](#), on page 35.

Related settings

See:

- ["Range n\(4\)_PUCCH/Range n\(5\)_PUCCH"](#) on page 243
- ["Number of Antenna Ports for PUCCH per PUCCH Format"](#) on page 257
- [Chapter 4.10, "Enhanced PUCCH settings"](#), on page 321

2.2.8.6 TDD special subframe configuration 10

From LTE Rel. 13 on, the specification is extended to support special subframe configuration 10, both in the downlink and in the uplink direction. The PUSCH in UpPTS follows a cell-specific configuration and can be configured independently for each user.

For overview information on the TDD frame structure, see ["Frame structure type 2 \(TDD\)"](#) on page 20.

Related settings

See:

- [Chapter 4.2.6, "TDD frame structure settings"](#), on page 100
- ["TDD Special Subframe Config"](#) on page 75
- ["TDD Special Subframe Config"](#) on page 225
- ["PUSCH in UpPTS"](#) on page 266

2.2.8.7 DMRS enhancements and DCI format 2C/2D

Starting from LTE Rel. 13, the transmission modes TM9 and TM10 can utilize new antenna ports, the AP11 and AP13, for one or two-layer transmissions and for transmit diversity.

DCI format 2C/2D carry the field "Ant. Port(s), Layers, SCID" which specifies the combination of used antenna ports, scrambling identity and number of layers ([TS 36.212](#)).

The value range of this field depends on the higher-layer parameters `semiOpenLoop` and `dmrs-tableAlt`.

Related settings

See:

- "DL Frame Configuration > General > Configure User > Tx Mode = TM9|TM10" > [DMRS Alt Table](#) and [Semi Open Loop](#)
- "DL Frame Configuration > (E)PDCCH > DCI Table > DCI Format = 2C/2D" > [DCI Format 2/2A/2B/2C/2D](#)
- "DL Frame Configuration > General > Configure User > Tx Mode = TM9|TM10 > Antenna Mapping > Config" > [User-Specific Antenna Port Mapping](#)
- "DL Frame Configuration > Subframe > PDSCH > Enhanced Settings > Config" > [Number of Layers](#), [Antenna Ports](#) and [Mapping Table](#)

3 Find out the implemented 3GPP specification

The Info dialog displays the currently supported version of the 3GPP standard.

Access:

- ▶ Select "EUTRA/LTE > Info".

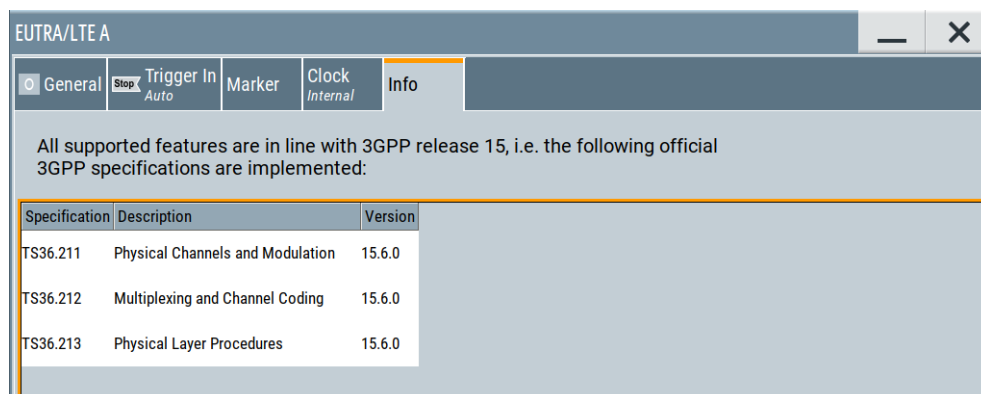

The default settings and parameters provided are oriented towards the specifications of the version displayed.

Remote command:

`[:SOURCE] :BB:EUTRa:VERSion?` on page 560

4 EUTRA/LTE configuration and settings

Access:

- ▶ Select "Baseband > EUTRA/LTE".

The remote commands required to define these settings are described in [Chapter 10, "Remote-control commands"](#), on page 554.

• General settings	61
• General DL settings / general TDD DL settings	68
• DL frame configuration settings	127
• Enhanced PBCH, PDSCH and PMCH settings	202
• DL antenna port mapping settings	213
• General UL settings	219
• UL frame configuration settings	243
• User equipment configuration	253
• Enhanced PUSCH settings	311
• Enhanced PUCCH settings	321

4.1 General settings

Access:

- ▶ Select "Baseband > EUTRA/LTE > General".

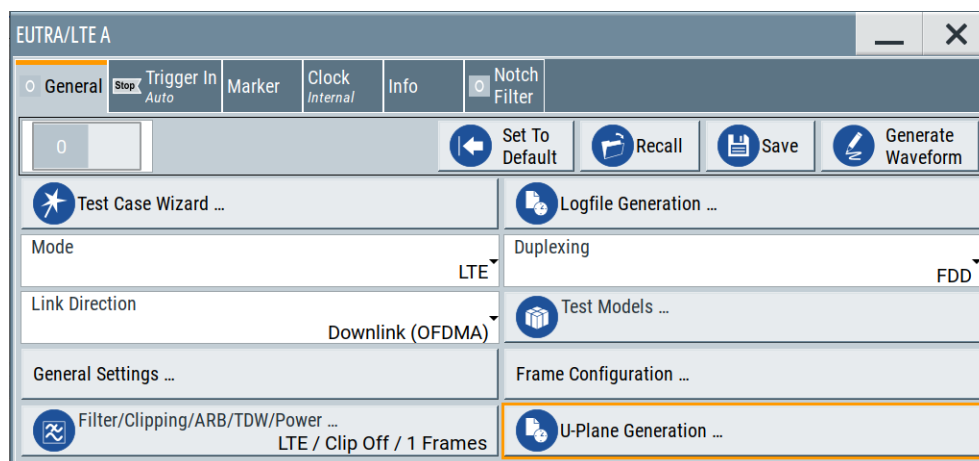

This dialog comprises the standard general settings, to the default and the "Save/ Recall" settings, as well as setting for defining the link direction or the used duplexing mode and access to dialogs with further settings. The choice of link direction determines which parameters are available.

Provided are the following settings:

State.....	62
Set to Default.....	62
Save/Recall.....	63
Generate Waveform.....	63
Test Case Wizard.....	63
Mode.....	64
Duplexing.....	64
Link Direction.....	64
Test Models.....	65
General DL Settings/General UL Settings.....	67
Frame Configuration.....	67
Filter/Clipping/ARB/TDW/Power Settings.....	68
U-Plane Generation.....	68

State

Activates the standard and deactivates all the other digital standards and digital modulation modes in the same path.

Remote command:

[:SOURce<hw>] :BB:EUTRa:STATe on page 556

Set to Default

Calls the default settings. The values of the main parameters are listed in the following table.

Parameter	Values
State	Not affected by "Set to Default"
Duplexing	FDD
Link Direction	Downlink (OFDMA)
Sequence Length	1 Frame
DL Channel Bandwidth	10 MHz
Physical Resource Block Bandwidth	12 * 15 kHz
Number Of Resource Blocks per Slot	50
Occupied Bandwidth /MHz	9.015
Sampling Rate /MHz	15.360
FFT Size	1024
Cell ID	0
Cyclic Prefix	Normal
PHICH Duration	Normal
Global MIMO Configuration	1 TxAntenna
Simulated Antenna	Antenna 1

Remote command:

[:SOURce<hw>] :BB:EUTRa:PRESet on page 557

Save/Recall

Accesses the "Save/Recall" dialog, i.e. the standard instrument function for storing and recalling the complete dialog-related settings in a file. The provided navigation possibilities in the dialog are self-explanatory.

The file name and the directory it is stored in are user-definable; the file extension is however predefined.

See also, chapter "File and Data Management" in the R&S SMM100A user manual.

Remote command:

`[:SOURce<hw>] :BB:EUTRa:SETTing:CATalog` on page 558

`[:SOURce<hw>] :BB:EUTRa:SETTing:LOAD` on page 558

`[:SOURce<hw>] :BB:EUTRa:SETTing:STORe` on page 559

`[:SOURce<hw>] :BB:EUTRa:SETTing:DEL` on page 558

Generate Waveform

With enabled signal generation, triggers the instrument to save the current settings of an arbitrary waveform signal in a waveform file with predefined extension `*.wv`. You can define the filename and the directory, in that you want to save the file.

Using the ARB modulation source, you can play back waveform files and/or process the file to generate multi-carrier or multi-segment signals.

If the current configuration uses coupled baseband sources with more than one Tx antenna (for example "System Config > Baseband (Tx Antennas) = 2"), with this function you trigger the software to generate the signals of all antennas. Created is a subset of waveform files, where the number of files corresponds to the number the currently simulated antennas and the file names have the following structure:

`<user-defined file name><antenna#-1>.wv`.

Example:

Select "System Config > Fading/Baseband Config > Mode > Advanced"

Select "System Config > Fading/Baseband Config > Baseband (Tx Antennas) = 4"

Select "System Config > Fading/Baseband Config > BB Source Config > Coupled"

Select "Baseband > EUTRA/LTE > General > State > On"

Select "EUTRA/LTE > General > Generate Waveform > On"

In the "Generate Waveform" dialog, use the default directory and enter "File Name = lte".

Select [Save/Rcl], select "File/Recall > File Manager" and in the directory tree open the default directory.

Displayed are four files, `lte.wv`, `lte1.wv`, `lte2.wv` and `lte3.wv`.

Remote command:

`[:SOURce<hw>] :BB:EUTRa:WAVEform:CREate` on page 560

Test Case Wizard

Accesses the "Test Case Wizard" dialog, see [Chapter 7, "Performing BS tests according to TS 36.141"](#), on page 494.

Mode

In instruments equipped with options R&S SMM-K55 and R&S SMM-K115, selects the standard to that the displayed settings belong.

If the instrument is equipped with one of these two options, the corresponding mode is selected automatically but the parameter "Mode" is not displayed.

"Mode"	Description	Required options
"LTE"	Standalone LTE IoT related settings and parameters are hidden.	R&S SMM-K55 (optionally also R&S SMM-K85)
"eMTC/NB-IoT"	Standalone IoT Configuration of parameters specified only for LTE is not possible.	R&S SMM-K115
"LTE/eMTC/NB-IoT"	Mixed LTE and IoT Allows mixed LTE and IoT configurations, for example for interoperability tests.	R&S SMM-K55 and R&S SMM-K115

Remote command:

[\[:SOURCE<hw>\]:BB:EUTRa:STDMode](#) on page 557

Duplexing

Selects the duplexing mode. The duplexing mode determines how the uplink and downlink signals are separated.

- "TDD" In TDD mode, the same frequency is used for both directions of transmission (uplink and downlink). With one baseband, either only downlink or only uplink can be generated.
- "FDD" In FDD mode, different frequencies are used for downlink and uplink directions.

Remote command:

[\[:SOURCE<hw>\]:BB:EUTRa:DUPLexing](#) on page 556

Link Direction

Selects the transmission direction.

"Downlink (OFDMA)"

The transmission direction selected is base station to user equipment. The signal corresponds to that of a base station. For the downlink, the physical layer mode is always set to OFDMA.

"Uplink (SC-FDMA)"

The transmission direction selected is user equipment to base station. The signal corresponds to that of a user equipment. For the uplink, the physical layer mode is always set to SC-FDMA.

Remote command:

[\[:SOURCE<hw>\]:BB:EUTRa:LINK](#) on page 557

Test Models

Accesses a dialog for selecting of:

- One of the EUTRA Test Models (E-TM) defined in [TS 36.141](#)



- One of the NB-IoT Test Models (N-TM) defined in [TS 36.141](#).

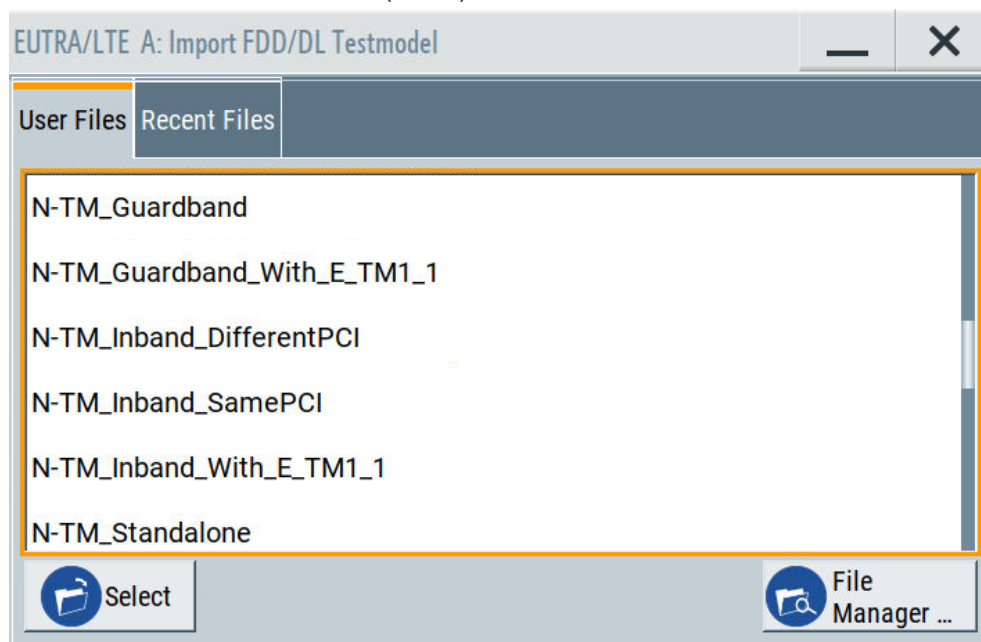

- Self-defined test setups
Use "Recent Files" button to display the files last used.
"File Manager" button opens the dialog to load or save configuration files. See also the section File and Data Management in the R&S SMM100A user manual.

The DL test models are predefined configurations of LTE settings. Three main groups of test models are defined, the E-TM1, E-TM2 and E-TM3. All test models use the following parameters:

- Single antenna port, single codeword, single layer and no precoding
- Duration of one frame
- Normal cyclic prefix

- Localized virtual resource blocks, no intra-subframe hopping for PDSCH
- UE-specific reference signals are not used

The data content of the physical channels and signals is defined in the 3GPP specification. Each test model is defined for six different channel bandwidths: 1.4 MHz, 3 MHz, 5 MHz, 10 MHz, 15 MHz and 20 MHz. The test models are defined for specific test purpose.

EUTRA test model	Defined for tests on
E-TM1.1	<ul style="list-style-type: none"> • BS output power • Unwanted emissions • Transmitter intermodulation • RS absolute accuracy
E-TM1.2	<ul style="list-style-type: none"> • ACLR • Operating band unwanted emissions
E-TM2	<ul style="list-style-type: none"> • Total power dynamic range (lower OFDM symbol power limit at min power) • EVM of single 64QAM PRB allocation (at min power) • Frequency error (at min power)
E-TM2a	<ul style="list-style-type: none"> • Total power dynamic range (lower OFDM symbol power limit at min power for 256QAM) • EVM of single 256QAM PRB allocation (at min power) • Frequency error (at min power)
E-TM2b	<ul style="list-style-type: none"> • Total power dynamic range (lower OFDM symbol power limit at min power for 1024QAM) • EVM of single 1024QAM PRB allocation (at min power) • Frequency error (at min power)
E-TM3.1	<ul style="list-style-type: none"> • Output power dynamics • Transmitted signal quality (Frequency error and EVM for 64QAM modulation, at max power)
E-TM3.1a	<ul style="list-style-type: none"> • Output power dynamics for 256QAM • Transmitted signal quality (Frequency error and EVM for 256QAM modulation, at max power)
E-TM3.1b	<ul style="list-style-type: none"> • Output power dynamics for 1024QAM • Transmitted signal quality (Frequency error and EVM for 1024QAM modulation, at max power)
E-TM3.2	Transmitted signal quality: <ul style="list-style-type: none"> • Frequency error • EVM for 16QAM modulation
E-TM3.3	Transmitted signal quality: <ul style="list-style-type: none"> • Frequency error • EVM for QPSK modulation
E-TM3.2	Transmitted signal quality: <ul style="list-style-type: none"> • Frequency error • EVM for 16QAM modulation
E-TM3.3	Transmitted signal quality: <ul style="list-style-type: none"> • Frequency error • EVM for QPSK modulation

The NB-IoT DL test models (N-TM) are predefined configurations of settings for NB-IoT tests. Supported are the following N-TMs:

- NB-IoT guard band operation
- NB-IoT guard band operation in combination with LTE E-TM1.1 carriers

- NB-IoT in-band operation, where NB-IoT and LTE use different PCIs
- NB-IoT in-band operation, where NB-IoT and LTE share the same PCI
- NB-IoT in-band operation in combination with LTE E-TM1.1 carriers
- NB-IoT standalone operation

According to [TS 36.141](#), all test models use the following parameters:

- Single antenna port
- Duration of 10 subframes or 10 ms
- Normal cyclic prefix
- The ration of synchronization signal EPRE and NRS EPRE is 0 dB
- NPDCCH format 1

With the option R&S SMM-K175 for O-RAN, the following test models in line with 3GPP TC 32.37x specifications are supported:

- ORAN-TC32371__x_yMHz
- ORAN-TC32372__x_yMHz
- ORAN-TC32373__x_yMHz
- ORAN-TC32374__x_yMHz
- ORAN-TC32375__x_yMHz
- ORAN-TC32376__x_yMHz
- ORAN-TC32376_TM3__x_yMHz
- ORAN-TC32376_TM4__x_yMHz

Where $x \in \{\text{FDD, TDD}\}$

Where $y \in \{1_4, 3, 5, 10, 15, 20\}$

Example: ORAN-TC32371__FDD_1_4MHz, ORAN-TC32376_TM3__TDD_5MHz

Remote command:

`[:SOURce<hw>] :BB:EUTRa:SETTing:TMOD:DL` on page 559

`[:SOURce<hw>] :BB:EUTRa:SETTing:TMOD:TDD` on page 559

General DL Settings/General UL Settings

Accesses the "General DL Settings / General UL Settings" dialog for configuring the EUTRA/LTE system.

For description of the available settings, refer to [Chapter 4.2, "General DL settings / general TDD DL settings"](#), on page 68 and [Chapter 4.6, "General UL settings"](#), on page 219 respectively.

Remote command:

n.a.

Frame Configuration

Accesses the "Frame Configuration" dialog for configuring the allocation of the resource blocks to the different users, as well as the configuration of the users.

The available settings depend on the selected link direction. For description, refer to [Chapter 4.3, "DL frame configuration settings"](#), on page 127 and [Chapter 4.7, "UL frame configuration settings"](#), on page 243 respectively.

Remote command:

n.a.

Filter/Clipping/ARB/TDW/Power Settings

Accesses the dialog for setting baseband filtering, clipping, and the sequence length of the arbitrary waveform component, see [Chapter 9.2, "Filter/clipping/ARB settings"](#), on page 531.

U-Plane Generation

Option: R&S SMM-K175

Opens a dialog to turn user plane data generation according to the O-RAN standard on and off.

The selected mode (Baseband > EUTRA/LTE > General > Mode) specifies the type of data to be generated: LTE, NB-IoT, or both.



For the supported O-RAN test models, see ["Test Models"](#) on page 65

For more information, see [Chapter 8, "Generating user plane data"](#), on page 528.

Remote command:

`[:SOURCE<hw>] :BB:EUTRa:UPLane:STATe` on page 560

4.2 General DL settings / general TDD DL settings

The "General DL Settings" dialog allows you to configure the EUTRA/LTE system for transmission direction downlink, i.e. the signal of one BS or one cell.

Access:

1. Select "General > Link Direction > Downlink (OFDMA)".
2. Select "General DL Settings".

The EUTRA/LTE standard defines no differences between TDD and FDD signals on the physical layer if only one link direction is considered at once. Therefore, the "General TDD DL Settings" dialog comprises the same parameters as the "General DL Settings" dialog but is extended with the [TDD frame structure settings](#) tab.

The "General DL Settings" dialog consists of several sections:

- [PDSCH scheduling settings](#).....69
- [DL carrier aggregation configuration](#).....70
- [MBSFN settings](#).....78
- [Physical settings](#).....92
- [Cell-specific settings](#).....96
- [TDD frame structure settings](#).....100
- [Downlink signals settings](#).....101
- [Antenna ports settings](#).....125

4.2.1 PDSCH scheduling settings

Access:

1. Select "General > Link Direction > Downlink (OFDMA)".
2. Select "General Settings > Scheduling".

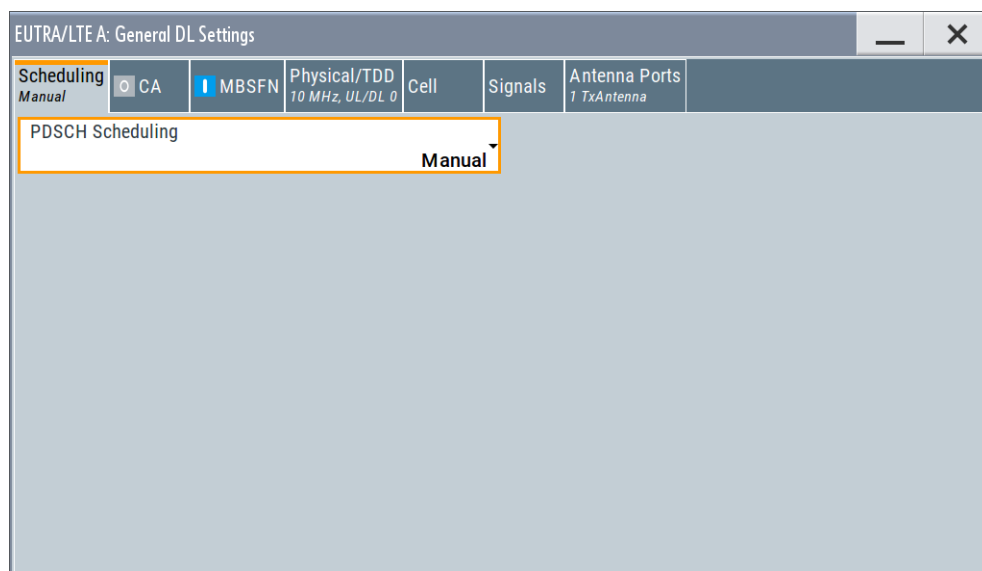

In the "Scheduling" section, you define whether the PDSCH Scheduling is performed manually, according to the configuration made for the DCIs or according to the required HARQ processes and redundancy versions.

Remote command:

[:SOURCE<hw>] :BB:EUTRA:DL:CONF:MODE on page 580

Overview of the scheduling methods

In the R&S SMM100A, there are different approaches to configure and schedule the different PDSCH allocations:

- Manually and with full flexibility ("Manual")
This is the default scheduling mode and the mode with full flexibility; you can configure any of the available settings.
There is no cross-reference between the settings made for the PDCCH DCIs and the PDSCHs settings. The configuration is performed on a subframe basis and you are responsible for the content of the PDSCH allocations.
- According to the configuration made for the DCIs ("Auto/DCI")
This is the mode supporting you to configure the precoding settings for spatial multiplexing according to [TS 36.211](#).
This mode assures a 3GPP compliant EUTRA/LTE signal and the PDSCH allocations are configured automatically according to the configuration of the PDCCH DCIs.

There are however limitations in the configuration flexibility, especially regarding the power setting, see "[Limitations and interdependencies in the Auto/DCI and Auto Sequence modes](#)" on page 70.

See also "[Switching between "Auto/DCI" and "Manual" modes](#)" on page 70.

Limitations and interdependencies in the Auto/DCI and Auto Sequence modes

The generation of a compliant signal requires some limitations in the configuration flexibility, especially regarding the power setting:

- The value of the parameter [Reference Signal Power](#) is fixed to 0dB.
- The PDSCH [Rho A](#) of each allocation belonging to a user is set as configured with the parameter [P_A](#) for the corresponding user in the "Configure User" dialog.
- All four users are activated with enabled [Scrambling](#) and [Channel Coding](#).
- Not all combinations of [DCI Table](#), [Users](#) and [UE_ID/n_RNTI](#) are allowed, see [Table 4-1](#).

Table 4-1: DCI Formats dependencies

User	UE ID/n_RNTI	DCI Format
User x	As defined for the corresponding user	0,1,1a,1b,1d,2,2a,2c,3,3a
P-RNTI	65534	1a,1c
SI-RNTI	65535	
RA-RNTI	As defined with the parameter "General DL Setting" > RA_RNTI	

Switching between "Auto/DCI" and "Manual" modes

- Switching from "Auto/DCI" mode to "Manual"
Enables all parameters in the DL allocation table for configuration without to change their values.
- Switching from "Manual" to "Auto/DCI" mode
Triggers a reset of the subframe configuration prior to reconfiguration of the PDSCH allocations according to the settings made for the PDCCH DCIs, that is the settings made in the DL allocation table are lost.

4.2.2 DL carrier aggregation configuration

Option: R&S SMM-K55 and R&S SMM-K85.

Access:

1. Select "General > Link Direction > Downlink (OFDMA)".

2. Select "General DL Settings > CA".

Cell Index	Phys. Cell ID	Bandwidth	Δf /MHz	Duplexing	UL/DL Config	Sp. SF Config	sched. CellIndex	CIF Pres.	Enhanced Settings	Power /dB	Delay /ns	State
0	0	10 MHz	0.000 000	FDD	-	-	0	<input type="checkbox"/>	Config...	0.00	0	On
1	1	10 MHz	0.000 000	FDD	-	-	1	<input type="checkbox"/>	Config...	0.00	0	Off
2	2	10 MHz	0.000 000	FDD	-	-	2	<input type="checkbox"/>	Config...	0.00	0	Off
3	3	10 MHz	0.000 000	FDD	-	-	3	<input type="checkbox"/>	Config...	0.00	0	Off
4	4	10 MHz	0.000 000	FDD	-	-	4	<input type="checkbox"/>	Config...	0.00	0	Off

PCell (FDD)

D D D D D D D D D D

The "General DL Settings > CA" dialog provides the settings for the configuration of one primary cell (PCell) and up to four secondary cells (SCell). In real system, the RRC messages signal all the relevant system information for a certain SCell. In this implementation, all relevant and configurable SCell settings are grouped in the "Carrier Aggregation" dialog. The remaining cell-specific settings are identical for all component carriers.

4.2.2.1 About DL carrier aggregation

This section lists implementation-related information. For background information on this topic, refer to [Chapter 2.2.5, "LTE Release 10 \(LTE-Advanced\) introduction"](#), on page 44.



In this description, the terms cell and component carrier (CC) are used interchangeably.

SCell settings derivation

The settings of each component carrier are calculated automatically from the configured PCell settings. They depend on the parameters in the "DL Carrier Aggregation Configuration" dialog. The following list provides an overview of the restrictions and interdependencies between related parameters if DL carrier aggregation is enabled:

- Combination of FDD and TDD is supported in "PDSCH Scheduling > Auto/DCI and Auto Sequence" modes
- Combination of TDD carriers with different UL/DL configuration or special subframe configuration is supported in "PDSCH Scheduling > Auto/DCI and Auto Sequence" modes
- Simultaneous support of LTE and LTE-A users is provided (See [User configuration settings > Activate CA](#)).

- To enable cross-carrier scheduling, the DCI formats are extended to support the CIF field.
The DCIs have to be configured individually per component carrier.
- The "Control Region for PDCCH" and the PHICH parameters "PHICH Duration" and "PHICH N_g" can have different values in the component carrier. The component carriers use different [Number of PHICH Groups](#), because the number of PHICH groups is calculated based on the parameter "N_g".
The cell-specific settings in the "Cell" tab correspond to the configuration of the PCell.
- If a SCell spans channel bandwidth with fewer RBs than the PCell, the instrument ignores the allocations or part of the them that is outside of the SCell channel bandwidth.

Supported LTE-A bandwidth

The LTE specification defines a maximum [Channel Bandwidth](#) of 20 MHz and aggregation of up to 5 component carriers. This achieves a 100 MHz bandwidth.

The R&S SMM100A configured to generate more than one component carrier automatically applies the multi-carrier function. In this case, the maximum bandwidth of the generated LTE-A signal depends on the installed options.

For more information, see data sheet.

4.2.2.2 How to enable carrier aggregation and cross-carrier scheduling

This section provides step-by-step instructions on how to use the settings to generate an LTE-A signal.

To enable carrier aggregation and cross-carrier scheduling



In the following, a general example is provided. Only the related settings are discussed.

1. Select "Baseband > EUTRA/LTE".
Configure the settings of the PCell as required. For example, select one of the pre-defined "Test Setups/Models".
2. To enable carrier aggregation:
 - a) Select "General DL Settings > DL Carrier Aggregation Configuration > Activate Carrier Aggregation > On"
 - b) Select "DL Frame Configuration > User Configuration".
Enable "Activate CA" per user as required.
3. In the "General DL Settings > DL Carrier Aggregation Configuration > Component Carrier Table" dialog, configure the settings of the SCells (see example on the following figure).

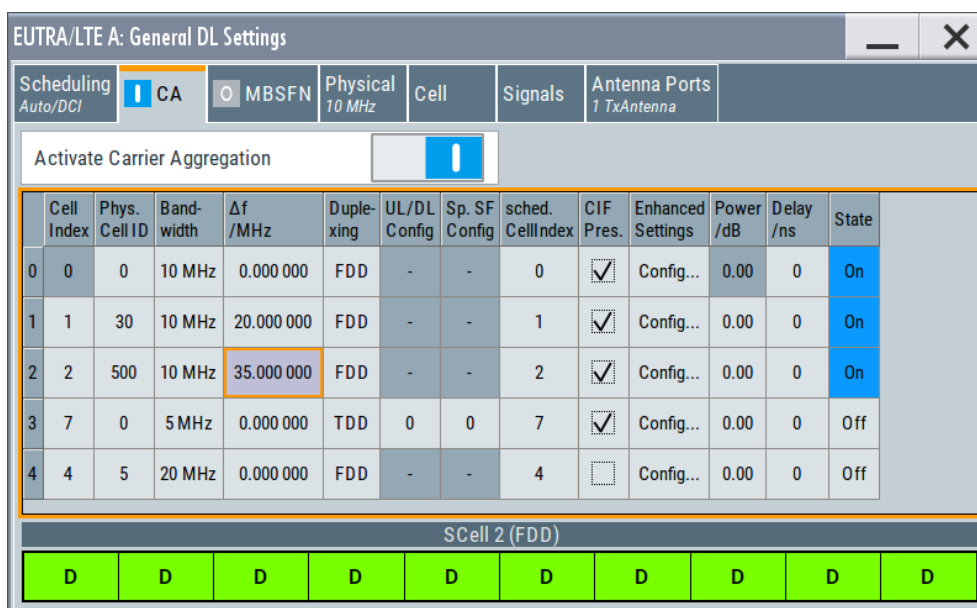

4. To enable cross-carrier scheduling for a certain component carrier:
 - a) Set the "DL Carrier Aggregation Configuration > SCell# > schedCell Index = 0" In the example, the component carriers SCell#1, SCell#2 and SCell#4 can be cross-scheduled over the PCell
 - b) Enable the "DL Carrier Aggregation Configuration > SCell# > CIF Present" parameter. In this example, the component carriers SCell#1 and SCell#2 is cross-scheduled over the PCell.
 - c) To enable a component carrier, set "DL Carrier Aggregation Configuration > SCell# > State > On".
5. Enable LTE signal generation "EUTRA/LTE State > On".
6. If necessary, adjust the RF frequency of the path to the middle frequency of the resulting total signal bandwidth.
7. Activate the RF output.

The instrument generates the signal in the path as multicarrier signal. The signal is composed of three carriers, the PCell, the SCell#1 and SCell#2. Each of the component carriers spans "Channel Bandwidth = 10 MHz"; the SCells use carrier frequency offset of 20 MHz and 35 MHz. The SCell#4 is disabled.

4.2.2.3 Carrier aggregation settings

Provided are the following settings:

Activate Carrier Aggregation.....	74
Component Carrier Table.....	74
L Cell Index.....	74
L Physical Cell ID.....	74

L Bandwidth.....	74
L delta f / MHz.....	75
L Duplexing.....	75
L TDD UL/DL Configuration.....	75
L TDD Special Subframe Config.....	75
L CIF Present.....	75
L sched. Cell Index.....	76
L Enhanced Settings.....	76
L PDSCH Start.....	76
L PHICH N_g.....	76
L PHICH Duration.....	77
L Power / dB.....	78
L Delay / ns.....	78
L State.....	78

Activate Carrier Aggregation

Enables/disables the generation of several component carriers.

Remote command:

[:SOURce<hw>] :BB:EUTRa:DL:CA:STATe on page 625

Component Carrier Table

The table provides the settings of the component carriers. The first row displays the settings of the PCell; the following four rows provide the configurable settings of the up to four SCells.

The PCell settings resemble the settings configured in the

The PCell settings resemble the settings configured in the "General DL Settings" dialog.

Cell Index ← Component Carrier Table

Sets the cell index of the corresponding SCell, as specified in TS 36.331. The SCell index is required for signaling on the DCI [DCI format configuration](#) field.

The cell index of the PCell is always 0.

Remote command:

[:SOURce<hw>] :BB:EUTRa:DL:CA:CELL<ch0>:INDex on page 627

Physical Cell ID ← Component Carrier Table

Sets the physical Cell ID of the corresponding SCell.

The physical Cell ID of the PCell is set by the parameter "General DL Settings" > [Cell ID](#)".

Remote command:

[:SOURce<hw>] :BB:EUTRa:DL:CA:CELL<ch0>:ID on page 626

Bandwidth ← Component Carrier Table

Sets the bandwidth of the corresponding component carrier/SCell.

Remote command:

[:SOURce<hw>] :BB:EUTRa:DL:CA:CELL<ch0>:BW on page 625

delta f / MHz ← Component Carrier Table

Sets the frequency offset between the central frequency of the SCell and the frequency of the PCell.

Remote command:

[:SOURCE<hw>] :BB:EUTRa:DL:CA:CELL<ch0>:DFReq on page 626

Duplexing ← Component Carrier Table

Selects the duplexing mode of the PCell.

- Without R&S SMM-K113
The duplexing mode of the SCells is set accordingly.
- Option: R&S SMM-K113
If "PDSCH Scheduling > Auto/DCI and Auto Sequence", combination of FDD and TDD is supported
- Option: R&S SMM-K119
If "PDSCH Scheduling > Auto/DCI and Auto Sequence", SCells can work in LAA mode.
LAA cells use FDD duplexing.

Remote command:

[:SOURCE<hw>] :BB:EUTRa:DL:CA:CELL<ch0>:DUPLexing on page 626

TDD UL/DL Configuration ← Component Carrier Table

Option: R&S SMM-K112

In TDD duplexing mode, sets the uplink-downlink configuration number. That is, defines which subframe is used for downlink respectively uplink, and where the special subframes are located.

In "PDSCH Scheduling > Auto/DCI and Auto Sequence" mode, the individual carriers can use different "UL/DL Configuration". The frame configuration of the selected carriers and the used duplexing are also displayed. Alternatively, use the [SC-FDMA time plan](#) to visualize them.

Remote command:

[:SOURCE<hw>] :BB:EUTRa:DL:CA:CELL<ch0>:UDConf on page 627

TDD Special Subframe Config ← Component Carrier Table

Option: R&S SMM-K112

In TDD duplexing mode, sets the special subframe configuration number.

Together with the parameter [Cyclic Prefix](#), this parameter defines the lengths of the DwPTS, the guard period and the UpPTS.

Remote command:

[:SOURCE<hw>] :BB:EUTRa:DL:CA:CELL<ch0>:SPSConf on page 627

CIF Present ← Component Carrier Table

Defines whether the [Carrier Indicator Field \(CIF\)](#) is included in the PDCCH DCI formats transmitted from the corresponding SCell.

Remote command:

[:SOURCE<hw>] :BB:EUTRa:DL:CA:CELL<ch0>:CIF on page 626

sched. Cell Index ← Component Carrier Table

Defines the component carrier/cell that signals the UL and DL grants for the selected SCell. The signaling cell is determined by its [Cell Index](#).

According to the LTE-A specification, cross-carrier scheduling has to be enabled per user and per component carrier.

To enable signaling for one particular SCell on the PCell, i.e. cross-carrier scheduling, set the "schedCell Index" to 0.

Remote command:

[:SOURCE<hw>] :BB:EUTRa:DL:CA:CELL<ch0>:SCINDEX on page 628

Enhanced Settings ← Component Carrier Table

Opens the "CA Enhanced Settings" dialog per component carrier.

EUTRA/LTE: CA Enhanced Settings (PCell)	
PDSCH Start	2
PHICH N_g	1/6
PHICH Duration	Normal

PDSCH Start ← Enhanced Settings ← Component Carrier Table

Sets the starting symbol of the PDSCH for the component carrier and determines the "Control Region for PDCCH".

Note: All subframes of a particular component carrier use the same "Control region for PDCCH" as defined here, regardless of the settings of the PCell.

Remote command:

[:SOURCE<hw>] :BB:EUTRa:DL:CA:CELL<ch0>:PSTART on page 628

PHICH N_g ← Enhanced Settings ← Component Carrier Table

Sets the parameter N_g according to [TS 36.211](#), section 6.9.

If [Activate Carrier Aggregation](#) > "On", you can define the PHICH duration per component carrier.

"1/6, 1/2, 1, 2" The used [Number of PHICH Groups](#) for the different subframes is calculated according to the following formula:

$$N_{PHICH}^{group} = \begin{cases} \lfloor N_g(N_{RB}^{DL}/8) \rfloor & \text{for normal cyclic prefix} \\ \lfloor 2 \cdot N_g(N_{RB}^{DL}/8) \rfloor & \text{for extended cyclic prefix} \end{cases}$$

In FDD mode, the calculated value corresponds directly to the parameter "Number of PHICH Groups".

In TDD mode, the number of PHICH groups is calculated as the product of the N_{PHICH}^{group} value multiplied with a coefficient selected from the following table.

UL/DL Configuration	Subframe number									
	0	1	2	3	4	5	6	7	8	9
0	2	1	-	-	-	2	1	-	-	-
1	0	1	-	-	1	0	1	-	-	1
2	0	0	-	1	0	0	0	-	1	0
3	1	0	-	-	-	0	0	0	1	1
4	0	0	-	-	0	0	0	0	1	1
5	0	0	-	0	0	0	0	0	1	0
6	1	1	-	-	-	1	1	-	-	1

The parameter [Number of PHICH Groups](#) is read-only.

"Custom" (for [Activate Carrier Aggregation](#) > "Off")

The parameter [Number of PHICH Groups](#) is configurable.

Remote command:

```
[ :SOURCE<hw> ] :BB:EUTRa:DL:CA:CELL<ch0>:PHICH:NGParameter  
on page 629
```

PHICH Duration ← Enhanced Settings ← Component Carrier Table

Sets the PHICH duration, i.e. the allocation of the PHICH resource element groups over the OFDM symbols.

The value selected puts the lower limit of the size of the [PCFICH settings](#) that is signaled by the PCFICH.

If [Activate Carrier Aggregation](#) > "On", you can define the PHICH duration per component carrier.

"Normal" All resources element groups of PHICH (see [Number of PHICH Groups](#)) are allocated on the first OFDM symbol (OFDM Symbol 0).

"Extended" The resources element groups of PHICH are distributed over three OFDM symbols for a normal subframe or over two symbols within a special one.

Remote command:

```
[ :SOURCE<hw> ] :BB:EUTRa:DL:CA:CELL<ch0>:PHICH:DURation on page 629
```

Power / dB ← Component Carrier Table

Sets the RS EPRE (reference signal energy per resource element) of the SCell relative to the RS EPRE of the PCell.

The absolute power of the RS of a cell is calculated according to the following formula:

$$\text{Absolute_RS_EPRE}_{\text{Cell}_X} = \text{RS Power per RE relative to Level Display} + \text{"Level Display"} + \text{CA_Power}_{\text{Cell}_X}$$

Example:

Set "EUTRA/LTE > Set to Default"

Set [Activate Carrier Aggregation](#) > On

For the SCell1, set $\text{CA_Power}_{\text{Cell}_1} = \text{Power / dB} = -5 \text{ dB}$

Enable SCell1, i.e. set [State](#) > On

The value of the parameter "General DL Settings" > [RS Power per RE relative to Level Display](#) is -30.736 dB

The power displayed in the status bar of the instrument is "Level = -30 dBm"

$$\text{Absolute_RS_EPRE}_{\text{Cell}_1} = (-30.736 \text{ dB}) + (-30.00 \text{ dBm}) + (-5 \text{ dB}) = -65.736 \text{ dBm}$$

Remote command:

`[:SOURCE<hw>] :BB:EUTRa:DL:CA:CELL<ch0>:POFFset` on page 628

Delay / ns ← Component Carrier Table

Sets the time delay of the SCell relative to the PCell.

Remote command:

`[:SOURCE<hw>] :BB:EUTRa:DL:CA:CELL<ch0>:TDELay` on page 628

State ← Component Carrier Table

Activates/deactivates the component carrier/SCell.

Remote command:

`[:SOURCE<hw>] :BB:EUTRa:DL:CA:CELL<ch0>:STATE` on page 629

4.2.3 MBSFN settings



Configuration of the "MBSFN Settings" requires the additional software option R&S SMM-K84.

The "MBSFN Settings" section comprises the parameters necessary to configure an MBSFN transmission. Refer to [Chapter 2.2.4, "LTE MBMS concepts"](#), on page 44 for background information.



According to the MBMS LTE concept, one eNodeB may serve more than one MBSFN areas. In this implementation, the simulated cell belongs to only one MBSFN area. Hence, all radio resources reserved for MBSFN subframes are assigned to one MBSFN area.

In an LTE network, the MBSFN information is transmitted only during the specially reserved MBSFN subframes. Almost all MBMS control information is carried by a special control channel, the MCCH. There is one MCCH per MBSFN area. In this implementation, the MCCH is always mapped to the first active MBSFN subframe within one MCCH repetition period (see figure in [Example "MBSFN Resource Allocation"](#) on page 81).

A configurable "MCCH repetition period" determines how frequent the control information is transmitted within a defined "MCCH modification period" (see [Figure 4-1](#)).

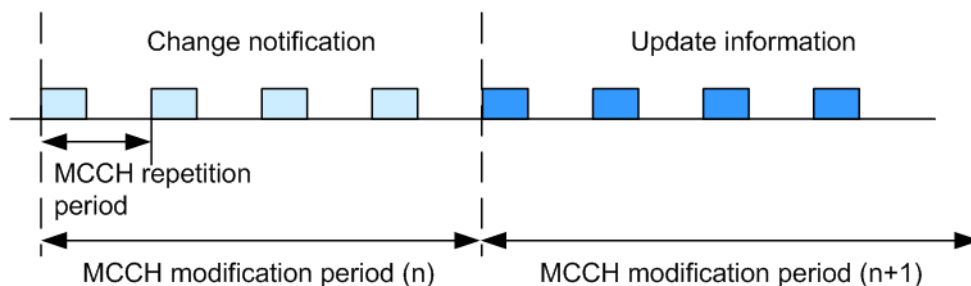

Figure 4-1: Change of MCCH information

The MCCH carries a single message, the *MBSFNAreaConfiguration* message, which provides information on the ongoing MBMS sessions and the corresponding radio resources, i.e. the mapping of the PMCHs. The BCCH also carries some of the MBMS control information by the special System Information Blocks SIB Type 13 and SIB Type 2.



For exact definition of control elements and messages such as *MBSFNAreaConfiguration*, refer to [TS 36.331](#).

The following table provides an overview of the steps an UE performs to acquire the information about the resource configuration of reserved MBSFN subframes, the position of the MCCH within the MBSFN subframes as well as information necessary to demodulate the MCCH and to retrieve the information about the PMCH scheduling.

Table 4-2: Acquiring MBSFN information

Step	Information provided by	Description	User Interface
1	BCCH > SIB#2 <ul style="list-style-type: none"> <i>MBSFN-SubframeConfiguration</i> 	The SIB#2 contains common radio configuration information and among other things a list (<i>mbsfn_SubframeConfigList</i>) with scheduling information for up to 8 MBSFN allocations (<i>MBSFN-SubframeConfiguration</i>). Hence, after receiving the SIB#2 each UE, also the MBSFN incapable UEs, are informed about the subframes that are reserved for MBSFN in the downlink.	Subframe Conf. (SIB Type 2)
2	BCCH > SIB#13 <ul style="list-style-type: none"> <i>MBSFN-AreaInfoList</i> <i>MBMS-NotificationConfiguration</i> 	The SIB#13 carries the information necessary to acquire the MBMS control information for up to 8 MBSFN areas (<i>MBSFN-AreaInfoList</i>), as well as the common MBMS notification scheduling information (<i>MBMS-NotificationConfiguration</i>). After receiving the SIB#13 the MBSFN capable UE is able to find the MBSFN reference signals (<i>mbsfn-AreaID</i>) and to detect and demodulate the MCCH (<i>mcch-Config</i> and <i>MBMS-NotificationConfiguration</i>).	MBSFN-AreaInfoList Parameters MBSFN-Notification-Config Parameters
3	MCCH > <i>MBSFNAreaConfiguration</i> <ul style="list-style-type: none"> <i>PMCH-InfoList</i> <i>CommonSF-Allocation-PatternList</i> 	The MCCH carries the single message <i>MBSFNAreaConfiguration</i> that determines which of the reserved MBSFN subframes (compare SIB#2) belong to which MBSFN area and provides a list with configuration information for up to 15 PMCHs (<i>PMCH-InfoList</i>) per an MBSFN area. Note: The <i>MBSFN-SubframeConfiguration</i> is equivalent to the summary of all <i>CommonSF-AllocationPatternList</i> . In this implementation, all MBSFN subframes are assigned to one MBSFN area. Hence, <i>MBSFN-SubframeConfiguration</i> equates the <i>CommonSF-AllocationPatternList</i> and configuration of the later one is done with the parameters of SIB#2. The <i>PMCH-InfoList</i> specifies the individual PMCHs, including MBMS sessions, used MCS, allocated subframes (<i>sf-AllocEnd</i>), and the periodicity for providing MCH scheduling information on MAC layer (<i>mch-SchedulingPeriod</i>).	Common Subframe Allocation Period PMCH-InfoList Parameters
4	PMCH	The UE receives the PMCHs.	

The illustrations on Figure 4-2 and Figure 4-3 show the signaling of MBSFN information during the acquisition steps.

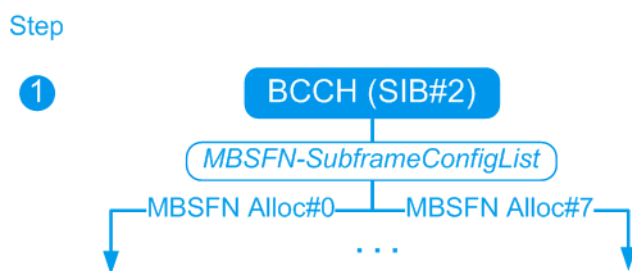

Figure 4-2: MBSFN Signaling (step 1)

Step

2

3

4

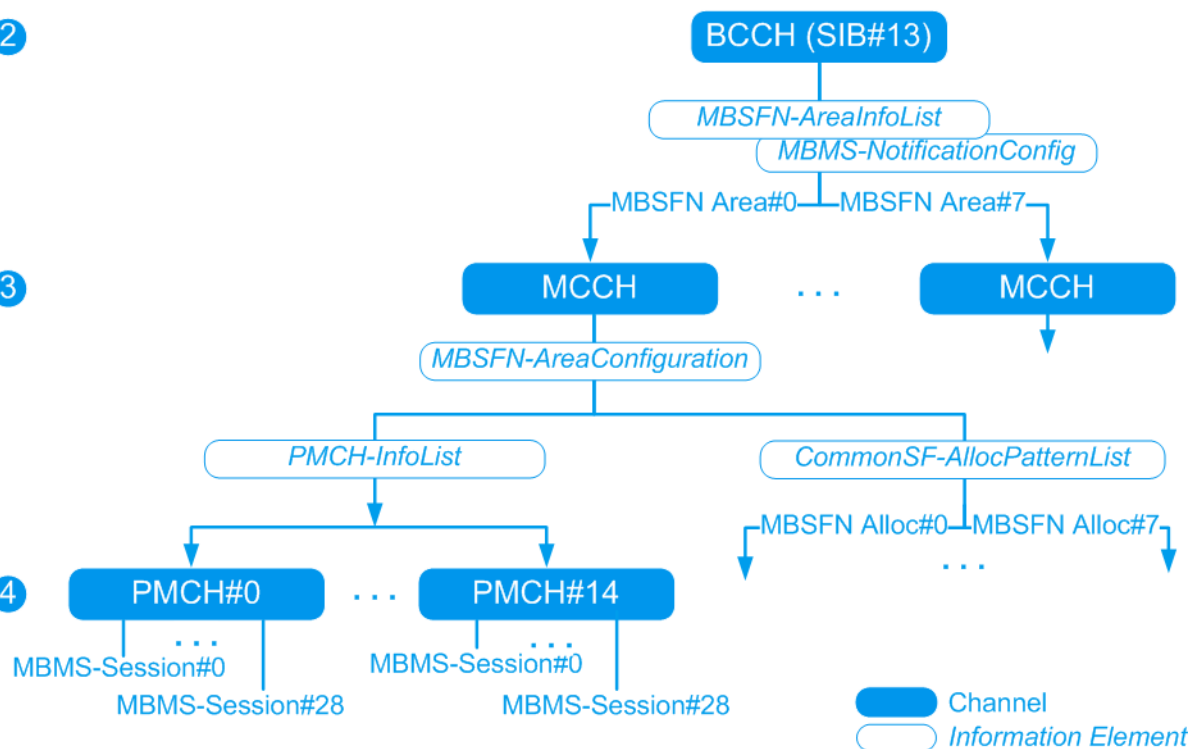

Figure 4-3: MBSFN Signaling (steps 2 to 4)

Example: MBSFN Resource Allocation

This example shows the MBSFN resource allocation for the settings listed in the following table. Use the default values for the other parameters.



ARB Sequence Length

The generation of a signal with cyclically repeating MBSFN pattern requires an "ARB sequence length" equal to the "MCCH repetition period" or to the "MCCH modification period".

The maximum value of the ARB sequence length depends on the selected channel bandwidth and on the memory size option of the generator.

Parameter	Value
EUTRA/LTE > Duplexing	FDD
EUTRA/LTE > Sequence Length	512 Frames
General DL Settings > Channel Bandwidth	1.4 MHz
General DL Settings > MBSFN Mode	Mixed
Radio Frame Allocation Period	8 Frames
Radio Frame Allocation Offset	2 Frames

Parameter	Value
Subframe Allocation Mode	4 Frames
Allocation value (HEX)	AAAAAA
MCCH State	On
MCCH Repetition Period	128 Frames
MCCH Modification Period	512 frames
Notification Repetition Coefficient	2 Frames
Notification Subframe Index	4, i.e. the MCCH change notification on PDCCH is transmitted on subframe#6
Common Subframe Allocation Period	64 Frames, i.e. the PMCH scheduling is repeated after 64 frames
Number of PMCHs	3
PMCH#0: SF Alloc Start/SF Alloc EndSF Alloc End	5
PMCH#0: MCH Scheduling Period	8
PMCH#1: SF Alloc End	7
PMCH#1: MCH Sched. Period	8
PMCH#2: SF Alloc End	95 (automatically calculated)
PMCH#2: MCH Sched. Period	8

See [Figure 4-4](#) for an illustration of the resource allocation.

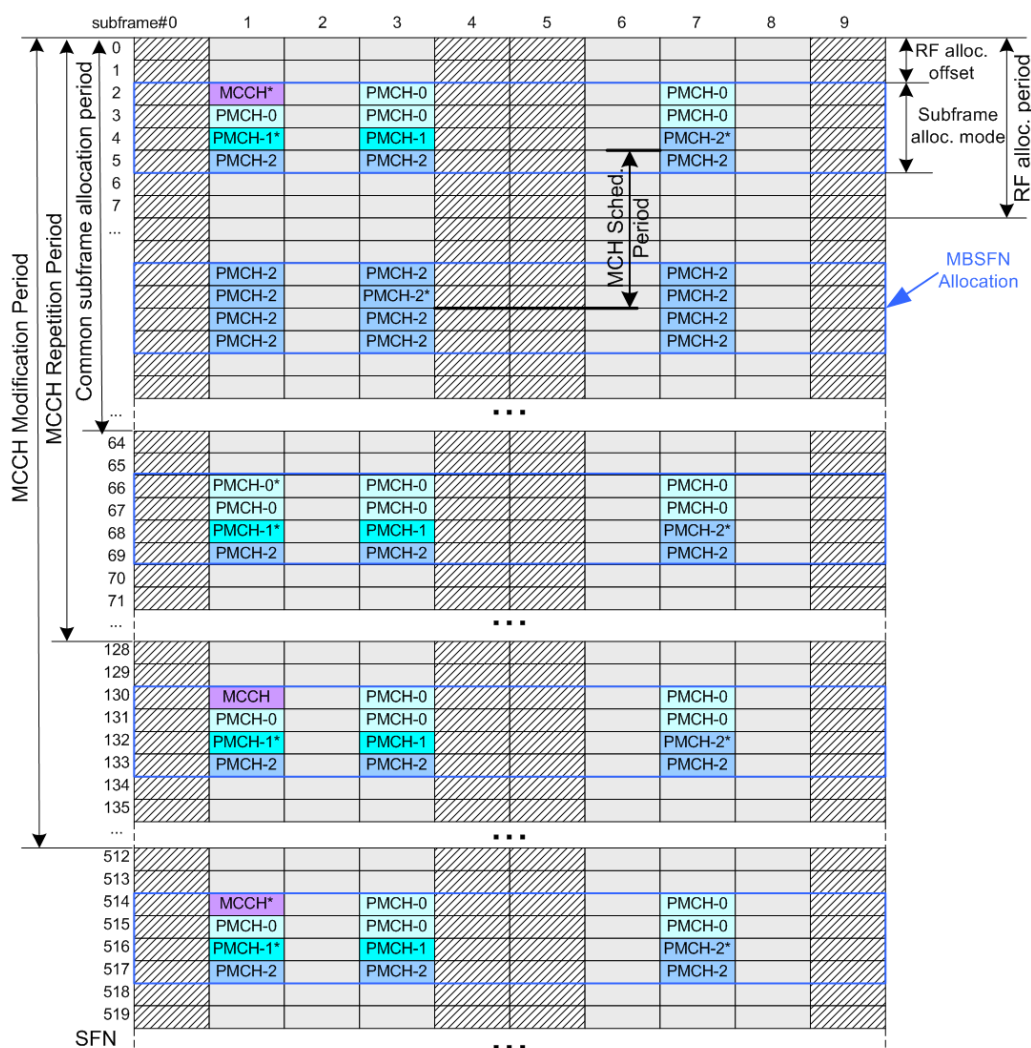

Figure 4-4: Example of MBSFN resource allocation

- SFN = System Frame Number
- Pattern subframes = Subframes not allowed to be scheduled as MBSFN subframes
- Grey subframes = MBSFN subframes not used for MBMS transmission, i.e. regular LTE subframes that can be used for allocation of DL signal
- MCCH* = First MCCH in a new MCCH modification period
- PMCH-0*/PMCH-1*/PMCH-2* = First PMCH of one MCH scheduling period.

By default, the SFN (System Frame Number) starts with 0. Use the parameter **SFN Offset** to adjust the start value.



If PRS and MBSFN are configured to be in the same subframe, MBSFN is skipped and PRS is transmitted solely (see [Example"Overlapping PDSCH, PRS and MBSFN"](#) on page 105).

To access the MBSFN dialog:

1. Select "General > Link Direction > Downlink (OFDMA)".

2. Select "General DL Settings > MBSFN > General" tab.
3. Select "MBSFN Mode > Mixed".

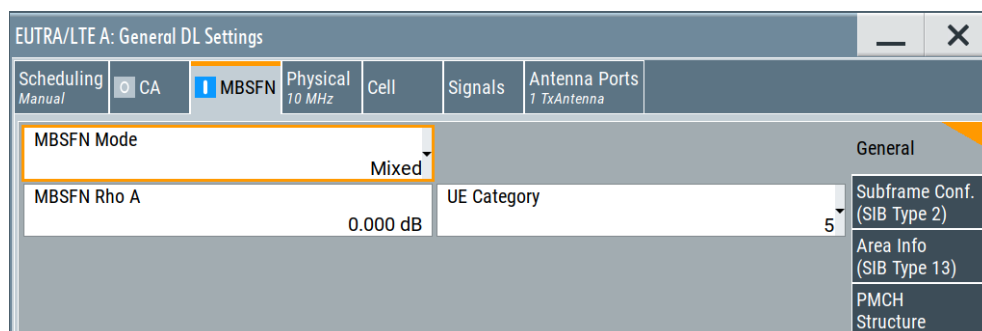

This dialog comprises the parameters necessary to configure an MBSFN transmission:

MBSFN Mode.....	85
MBSFN Rho A.....	85
UE Category.....	85
Subframe Conf. (SIB Type 2).....	85
L Radio Frame Allocation Period.....	86
L Radio Frame Allocation Offset.....	86
L Subframe Allocation Mode.....	86
L Allocation value (HEX).....	86
Area Info (SIB Type 13).....	86
L MBSFN-AreaInfoList Parameters.....	87
L Area ID (N_ID_MBSFN).....	87
L Non-MBSFN Region Length.....	87
L Notification Indicator.....	88
L MCCH State.....	88
L MCCH Repetition Period.....	88
L MCCH Offset.....	88
L MCCH Modification Period.....	88
L Allocation Value (HEX).....	88
L MCCH Data.....	89
L MCCH MCS.....	89
L MCCH Modulation.....	89
L MCCH Transport Block Size.....	89
L MCCH Data Source.....	89
L MBSFN-NotificationConfig Parameters.....	89
L Notification Repetition Coefficient.....	89
L Notification Offset.....	90
L Notification Subframe Index.....	90
L Notification Pattern.....	90
PMCH Structure.....	90
L Common Subframe Allocation Period.....	90
L PMCH-InfoList Parameters.....	91
L Number of PMCHs.....	91
L SF Alloc Start/SF Alloc End.....	91

L	Use Table 2.....	91
L	MCS.....	92
L	Modulation.....	92
L	MCH Scheduling Period.....	92
L	Data Source.....	92
L	State.....	92

MBSFN Mode

Enables the MBSFN transmission and selects a mixed MBSFN Mode, i.e. the available subframes are shared between MBSFN and regular LTE operation.

Note: Dedicated MBSFN Mode (i.e. all subframes are used for MBSFN solely) will be supported in a later version.

Remote command:

[:SOURCE<hw>] :BB:EUTRa:DL:MBSFn:MODE on page 620

MBSFN Rho A

Defines the power of the MBSFN channels relative to the common Reference Signals.

Remote command:

[:SOURCE<hw>] :BB:EUTRa:DL:MBSFn:RHOA on page 623

UE Category

Defines the UE category as defined in TS 36.306.

Remote command:

[:SOURCE<hw>] :BB:EUTRa:DL:MBSFn:UEC on page 624

Subframe Conf. (SIB Type 2)

Access: "MBSFN > Subframe Conf. (SIB Type 2)" tab.

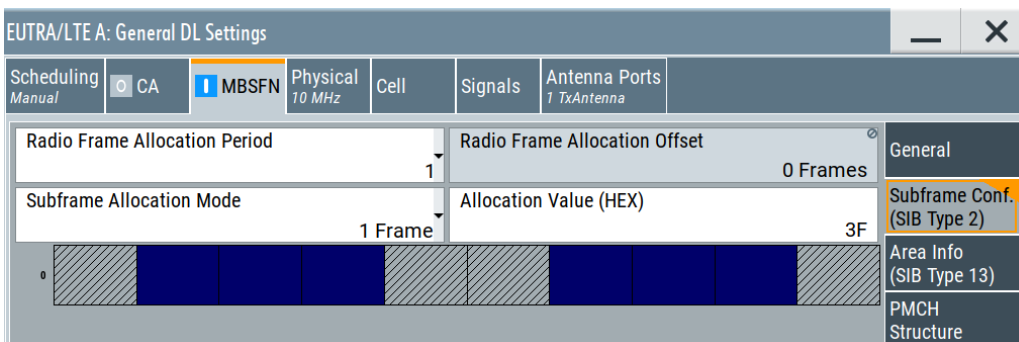

This section comprises settings for configuration of the general MBSFN structure, i.e. it defines which subframes are used for MBSFN transmission. In the "real" system, these values are transmitted via the System Information Block (SIB) Type 2.

The parameters in this section correspond to the MBMS information element *MBSFN-SubframeConfig*, as defined in TS 36.331.

The graph in this section displays the currently reserved MBSFN subframes. To select a subframe as MBSFN subframe, click on this subframe.

Note: The here described parameters are for configuration of the MBSFN structure only, the coding of the SIB#2 and the SIB#13 is not done automatically.

Also, the content of the MCCH is not generated automatically, but has to be set manually, by selecting the data source.

Radio Frame Allocation Period ← Subframe Conf. (SIB Type 2)

Radio-frames that contain MBSFN subframes occur when the following equation is satisfied:

$$\text{SFN} \bmod \text{radioFrameAllocationPeriod} = \text{radioFrameAllocationOffset}$$

Remote command:

[:SOURCE<hw>] :BB:EUTRa:DL:MBSFn:SC:APER on page 624

Radio Frame Allocation Offset ← Subframe Conf. (SIB Type 2)

Radio-frames that contain MBSFN subframes occur when the following equation is satisfied:

$$\text{SFN} \bmod \text{radioFrameAllocationPeriod} = \text{radioFrameAllocationOffset}$$

Remote command:

[:SOURCE<hw>] :BB:EUTRa:DL:MBSFn:SC:AOffset on page 623

Subframe Allocation Mode ← Subframe Conf. (SIB Type 2)

Defines whether MBSFN periodic scheduling is 1 or 4 frames.

The figure in [Example "MBSFN Resource Allocation"](#) on page 81 shows an MBSFN allocation composed of 4 frames. The following figure displays an MBSFN allocation with "Subframe allocation mode" set to 1 frame.

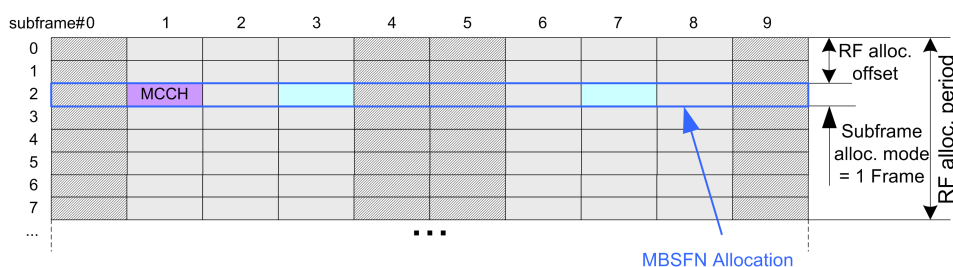

Remote command:

[:SOURCE<hw>] :BB:EUTRa:DL:MBSFn:SC:AMODE on page 623

Allocation value (HEX) ← Subframe Conf. (SIB Type 2)

Defines which MBSFN subframes are allocated.

This parameter is identical to the bitmap defined by the field *subframeAllocation* of the MBMS information element *MBSFN-SubframeConfig*.

Remote command:

[:SOURCE<hw>] :BB:EUTRa:DL:MBSFn:SC:AVAL on page 624

Area Info (SIB Type 13)

Access: "MBSFN > Area Info (SIB Type 13)" tab.

This section comprises settings for configuration of the general MBSFN area info, i.e. it defines where to find the MCCH. In the "real" system, these values are transmitted via the System Information Block (SIB) Type 13.

The parameters in this section correspond to the MBMS information elements *MBSFN-AreaInfoList* and *MBSFN-NotificationConfig*, as defined in TS 36.331.

Note: The here described parameters are for configuration of the MBSFN structure only, the coding of the SIB#2 and the SIB#13 is not done automatically. Also the content of the MCCH is not generated automatically, but has to be set manually, by selecting of a data source.

EUTRA/LTE A: General DL Settings						
Scheduling <i>Manual</i>	CA	MBSFN	Physical 10 MHz	Cell	Signals	Antenna Ports 1 TxAntenna
Area ID (N_ID_MBSFN)	0	Non-MBSFN Region Length	2 OFDMA Sym.			
Notification Indicator	0	MCCH State	<input checked="" type="checkbox"/>			
MCCH Repetition Period	32 Frames	MCCH Offset	0			
MCCH Modification Period	512 Frames	Allocation Value (HEX)	20			
MCCH Data						
MCCH MCS	2	MCCH Modulation	QPSK			
MCCH Transport Block Size	2 216					
MCCH Data Source	PN9					
Notification Parameters						
Notification Repetition Coefficient	2	Notification Offset	0			
Notification Subframe Index	1	Notification Pattern	0...			

MBSFN-AreaInfoList Parameters ← Area Info (SIB Type 13)

This section comprises the scheduling parameters of the MBMS information element *MBSFN-AreaInfoList*.

Area ID (N_ID_MBSFN) ← MBSFN-AreaInfoList Parameters ← Area Info (SIB Type 13)

Defines the MBSFN area ID, parameter N_{id}^{MBSFN} .

Remote command:

[:SOURCE<hw>] :BB:EUTRa:DL:MBSFn:AI:ID on page 615

Non-MBSFN Region Length ← MBSFN-AreaInfoList Parameters ← Area Info (SIB Type 13)

Defines how many symbols from the beginning of the subframe constitute the non-MBSFN region.

Remote command:

[:SOURCE<hw>] :BB:EUTRa:DL:MBSFn:AI:NMRL on page 619

Notification Indicator ← **MBSFN-AreaInfoList Parameters** ← **Area Info (SIB Type 13)**

Defines which PDCCH bit is used to notify the UE about change of the MCCH applicable for this MBSFN area. Value 0 corresponds to the least significant bit as defined for the [DCI Format 1C](#).

Remote command:

[:SOURCE<hw>] :BB:EUTRa:DL:MBSFn:AI:NIND on page 619

MCCH State ← **MBSFN-AreaInfoList Parameters** ← **Area Info (SIB Type 13)**

Enables/disables the MCCH.

Remote command:

[:SOURCE<hw>] :BB:EUTRa:DL:MBSFn:AI:MCCH:STATE on page 618

MCCH Repetition Period ← **MBSFN-AreaInfoList Parameters** ← **Area Info (SIB Type 13)**

Defines the interval between transmissions of MCCH information in radio frames.

Remote command:

[:SOURCE<hw>] :BB:EUTRa:DL:MBSFn:AI:MCCH:RPER on page 618

MCCH Offset ← **MBSFN-AreaInfoList Parameters** ← **Area Info (SIB Type 13)**

Indicates, together with the "MCCH repetition period", the radio frames in which MCCH is scheduled. MCCH is scheduled in radio frames for which:

$SFN \bmod \text{"MCCH repetition period"} = \text{"MCCH offset"}$

Remote command:

[:SOURCE<hw>] :BB:EUTRa:DL:MBSFn:AI:MCCH:OFFS on page 618

MCCH Modification Period ← **MBSFN-AreaInfoList Parameters** ← **Area Info (SIB Type 13)**

Defines periodically appearing boundaries, i.e. radio frames for which the following equation is fulfilled:

$SFN \bmod \text{"MCCH modification period"} = 0$

The contents of different transmissions of MCCH information can only be different if there is at least one such boundary in-between them.

Remote command:

[:SOURCE<hw>] :BB:EUTRa:DL:MBSFn:AI:MCCH:MPER on page 616

Allocation Value (HEX) ← **MBSFN-AreaInfoList Parameters** ← **Area Info (SIB Type 13)**

Indicates the subframes of the radio frames indicated by the "MCCH repetition period" and the "MCCH offset" that may carry MCCH.

Note: In the current implementation, the MCCH is always mapped to the first active MBSFN subframe.

Remote command:

[:SOURCE<hw>] :BB:EUTRa:DL:MBSFn:AI:MCCH:AVAL? on page 615

MCCH Data ← Area Info (SIB Type 13)

This section configures MCCH parameters of the MBMS information element *MBSFN-AreaInfoList*.

MCCH MCS ← MCCH Data ← Area Info (SIB Type 13)

Defines the Modulation and Coding Scheme (MCS) applicable for the subframes indicated by the "MCCH Allocation value" and for the first subframe of each MCH scheduling period (which may contain the MCH scheduling information provided by MAC).

Remote command:

[:SOURCE<hw>] :BB:EUTRa:DL:MBSFn:AI:MCCH:MCS on page 616

MCCH Modulation ← MCCH Data ← Area Info (SIB Type 13)

Displays the values as determined by the "MCCH MCS".

Remote command:

[:SOURCE<hw>] :BB:EUTRa:DL:MBSFn:AI:MCCH:MODulation? on page 616

MCCH Transport Block Size ← MCCH Data ← Area Info (SIB Type 13)

Displays the values as determined by the "MCCH MCS".

Remote command:

[:SOURCE<hw>] :BB:EUTRa:DL:MBSFn:AI:MCCH:TBSize? on page 619

MCCH Data Source ← MCCH Data ← Area Info (SIB Type 13)

Sets the data source used for the MCCH.

Remote command:

[:SOURCE<hw>] :BB:EUTRa:DL:MBSFn:AI:MCCH:DATA on page 615

[:SOURCE<hw>] :BB:EUTRa:DL:MBSFn:AI:MCCH:DLISt on page 615

[:SOURCE<hw>] :BB:EUTRa:DL:MBSFn:AI:MCCH:PATtern on page 618

MBSFN-NotificationConfig Parameters ← Area Info (SIB Type 13)

This section comprises the parameters of the MBMS information element *MBSFN-NotificationConfig*.

Notification Repetition Coefficient ← MBSFN-NotificationConfig Parameters ← Area Info (SIB Type 13)

Selects the current change notification repetition period common for all MCCHs that are configured. The notification repetition period is calculated as follows:

change notification repetition period = shortest modification period / "Notification repetition coefficient"

Where the *shortest modification period* corresponds with the value of the selected "MCCH modification period".

Remote command:

[:SOURCE<hw>] :BB:EUTRa:DL:MBSFn:AI:MCCH:NRC on page 617

Notification Offset ← MBSFN-NotificationConfig Parameters ← Area Info (SIB Type 13)

Defines, together with the "Notification Repetition Coefficient", the radio frames in which the MCCH information change notification is scheduled, i.e. the MCCH information change notification is scheduled in radio frames for which:

$$SFN \text{ mod notification repetition period} = \text{"Notification offset"}$$

Remote command:

```
[ :SOURCE<hw> ] :BB:EUTRa:DL:MBSFn:AI:MCCH:NOFFset on page 616
```

Notification Subframe Index ← MBSFN-NotificationConfig Parameters ← Area Info (SIB Type 13)

Defines the subframe used to transmit MCCH change notifications on PDCCH.

In FDD: Values 1, 2, 3, 4, 5 and 6 correspond with subframe #1, #2, #3, #6, #7 and #8 respectively.

In TDD: Values 1, 2, 3, 4 and 5 correspond with subframe #3, #4, #7, #8 and #9 respectively.

Remote command:

```
[ :SOURCE<hw> ] :BB:EUTRa:DL:MBSFn:AI:MCCH:NSI on page 617
```

Notification Pattern ← MBSFN-NotificationConfig Parameters ← Area Info (SIB Type 13)

Sets the pattern for the notification bits sent on PDCCH DCI format 1c.

Remote command:

```
[ :SOURCE<hw> ] :BB:EUTRa:DL:MBSFn:AI:MCCH:NPATtern on page 617
```

PMCH Structure

Access: "MBSFN > PMCH Structure" tab.

This section comprises settings for configuration of the PMCH structure, i.e. where to find a PMCH carrying a certain MTCH. In the "real" system, these values are transmitted via the MCCH (*MBSFNAreaConfiguration*).

The parameters in this section correspond to the MBMS information elements *MBSFNAreaConfiguration* and *PMCH-InfoList*, as defined in TS 36.331.

PMCH Structure										
Common SF Alloc Period							Number of PMCHs			
64							3			
	SF Alloc Start	SF Alloc End	Use Table 2	MCS	Modulation	Scheduling Period	Data Source	DList Pattern	State	
0	0	0	<input type="checkbox"/>	0	QPSK	-	PN9	-	On	
1	1	1	<input type="checkbox"/>	0	QPSK	-	PN9	-	On	
2	2	383	<input type="checkbox"/>	0	QPSK	-	PN9	-	On	

Common Subframe Allocation Period ← PMCH Structure

Defines the period during which resources corresponding with field *commonSF-Alloc* are divided between the (P)MCHs that are configured for this MBSFN area.

The subframe allocation patterns, as defined by *commonSF-Alloc*, repeat continuously during this period.

Remote command:

[:SOURCE<hw>] :BB:EUTRa:DL:MBSFn:MTCH:CSAP on page 620

PMCH-InfoList Parameters ← **PMCH Structure**

Comprises the parameters of the *PMCH-InfoList*.

Number of PMCHs ← **PMCH-InfoList Parameters** ← **PMCH Structure**

Defines the number of PMCHs in this MBSFN area.

Remote command:

[:SOURCE<hw>] :BB:EUTRa:DL:MBSFn:MTCH:NPMChs on page 620

SF Alloc Start/SF Alloc End ← **PMCH-InfoList Parameters** ← **PMCH Structure**

Defines the first/last subframe allocated to this (P)MCH within a period identified by field *commonSF-Alloc*.

The subframes allocated to (P)MCH corresponding with the n^{th} entry in *pmch-InfoList* are the subsequent subframes starting from either the subframe identified by "SF Alloc End" of the $(-1)^{\text{th}}$ listed (P)MCH or, for $n=1$, the first subframe, through the subframe identified by "SF Alloc End" of the n^{th} listed (P)MCH. Value 0 corresponds with the first subframe defined by field *commonSF-Alloc*.

Note: Configuring the MCHs ("SF Allocation Start" values) from bottom to top. Although the 3GPP specification defines the "SF Alloc End" parameter as the only one required, in this implementation it is mandatory to define the "SF Alloc Start" instead. The implemented algorithm uses the selected "SF Alloc Start" and calculates automatically the "SF Alloc End" of the corresponding MCH. The algorithm applies the internal rule, that there is no gap between two consequent MCHs.

It is therefore recommended to configure the MCHs, i.e. define the "SF Alloc Start" values, from bottom to the top. This workaround prevents the configuration of overlapping MCHs.

Remote command:

[:SOURCE<hw>] :BB:EUTRa:DL:MBSFn:PMCH<ch0>:SASStart on page 623

[:SOURCE<hw>] :BB:EUTRa:DL:MBSFn:PMCH<ch0>:SAEnd on page 623

Use Table 2 ← **PMCH-InfoList Parameters** ← **PMCH Structure**

(requires option R&S SMM-K113)

Defines which of the two tables defined in [TS 36.213](#) is used to specify the used modulation and coding scheme (see [MCS](#) and [Modulation](#)):

- "Use Table 2 > Off": Table 7.1.7.1-1 is used
- "Use Table 2 > On": Table 7.1.7.1-1A is used.

Example:

For "MCS = 5" and "Use Table 2 > Off", the used modulation is "Modulation > QPSK".

If "Use Table 2 > On", the used modulation changes to "Modulation > 16QAM".

Remote command:

[:SOURCE<hw>] :BB:EUTRa:DL:MBSFn:PMCH<ch0>:MCSTwo on page 621

MCS ← PMCH-InfoList Parameters ← PMCH Structure

Defines the value for parameter according to TS 36.213 Table 7.1.7.1-1 or Table 7.1.7.1-1A, which defines the Modulation and Coding Scheme (MCS) applicable for the subframes of this (P)MCH as indicated by the field *commonSF-Alloc*. The MCS does however neither apply to the subframes that may carry MCCH, i.e. the subframes indicated by the field *sf-AllocInfo* within System Information Block Type 13, nor for the first subframe of each MCH scheduling period (which may contain the MCH scheduling information provided by the MAC).

To select which one of the two tables Table 7.1.7.1-1 or Table 7.1.7.1-1A is used, use the parameter [Use Table 2](#). Using Table 7.1.7.1-1A requires option R&S SMM-K113.

Remote command:

[:SOURCE<hw>] :BB:EUTRa:DL:MBSFn:PMCH<ch0>:MCS on page 622

Modulation ← PMCH-InfoList Parameters ← PMCH Structure

Indicates the used modulation, as defined with:

- [Use Table 2](#)
- MCS

Remote command:

[:SOURCE<hw>] :BB:EUTRa:DL:MBSFn:PMCH<ch0>:MOD? on page 622

MCH Scheduling Period ← PMCH-InfoList Parameters ← PMCH Structure

Defines the MCH scheduling period, i.e. the periodicity used for providing MCH scheduling information at lower layers (MAC) applicable for an MCH.

Note: The first subframe of the scheduling period may contain the MAC control element and therefore uses MCS of MCCH (however, the data source from PMCH is still used).

Remote command:

[:SOURCE<hw>] :BB:EUTRa:DL:MBSFn:PMCH<ch0>:SPERiod on page 622

Data Source ← PMCH-InfoList Parameters ← PMCH Structure

Sets the data source for this PMCH/MTCH.

Remote command:

[:SOURCE<hw>] :BB:EUTRa:DL:MBSFn:PMCH<ch0>:DATA on page 621

[:SOURCE<hw>] :BB:EUTRa:DL:MBSFn:PMCH<ch0>:DLISt on page 621

[:SOURCE<hw>] :BB:EUTRa:DL:MBSFn:PMCH<ch0>:PATtern on page 621

State ← PMCH-InfoList Parameters ← PMCH Structure

Enables/disables the selected PMCH/MTCH.

Remote command:

[:SOURCE<hw>] :BB:EUTRa:DL:MBSFn:PMCH<ch0>:STATe on page 620

4.2.4 Physical settings

Access:

1. Select "General > Link Direction > Downlink (OFDMA)".

2. Select "General DL Settings > Physical".

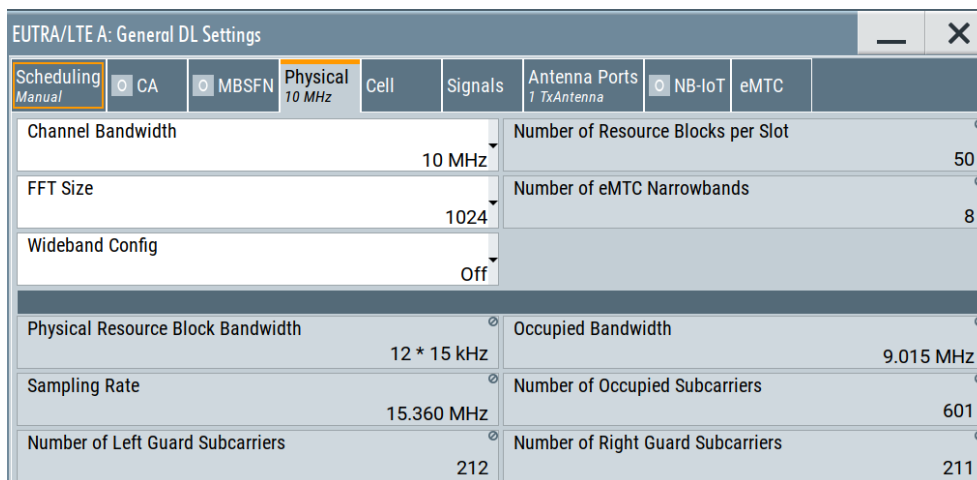

In this dialog, the channel bandwidth respectively the number of resource blocks per slot is selected. The other parameters are fixed and read-only.

Channel Bandwidth.....	93
Number of Resource Blocks Per Slot.....	94
FFT Size.....	94
Number of eMTC Narrowbands.....	94
Number of eMTC Widebands.....	95
Wideband Config.....	95
Physical Resource Block Bandwidth.....	95
Occupied Bandwidth.....	95
Sampling Rate.....	96
Number Of Occupied Subcarriers.....	96
Number Of Left/Right Guard Subcarriers.....	96

Channel Bandwidth

Sets the channel bandwidth of the EUTRA/LTE system.

The 3GPP specification defines bandwidth agnostic layer 1 where the channel bandwidth is determined by specifying the desired number of resource blocks. However, the current EUTRA standardization focuses on six bandwidths.

- "1.4 MHz, 3 MHz, 5 MHz, 10 MHz, 15 MHz, 20 MHz"
 Select a predefined channel bandwidth.
 The parameter "Number of Resource Blocks Per Slot" is internally calculated for the selected "Channel Bandwidth" and "Physical Resource Block Bandwidth".
 The sampling rate, occupied bandwidth and FFT size are therefore determined by the parameter "Number of Resource Blocks Per Slot". If necessary, adjust the "FFT Size".
 See also [Table 2-1](#) for an overview of the cross-reference between the parameters. If "Mode > eMTC/NB-LoT or LTE/eMTC/NB-LoT" is selected, the "1.4 MHz" bandwidth is supported by LTE and eMTC; the NB-LoT-specific settings are not available for configuration.
- "200 kHz"
 Option: R&S SMM-K115

This channel bandwidth is **dedicated to NB-IoT**. It is available, if "Mode > eMTC/NB-IoT or LTE/eMTC/NB-IoT" is selected.

If channel bandwidth of 200 kHz is used, the LTE or eMTC-specific settings are not available for configuration. Available is only one NB-IoT carrier which works in standalone mode (**Mode** = "Standalone").

- "User"
Option: R&S SMM-K55
Provided for backward compatibility with previous version of this software, this parameter allows you to select a user-defined bandwidth as number of resource blocks.

Remote command:

[:SOURce<hw>] :BB:EUTRa:DL:BW on page 584

Number of Resource Blocks Per Slot

Indicates the number of used resource blocks for the selected "Channel Bandwidth".

"Channel Bandwidth"	"Number of Resource Blocks Per Slot (UL)"
"1.4 MHz, 3 MHz, 5 MHz, 10 MHz, 15 MHz, 20 MHz"	Read-only value, set automatically as function of the "Channel Bandwidth" and "Physical Resource Block Bandwidth"
"User"	"Channel Bandwidth" depends on the "Number of Resource Blocks Per Slot" and "Physical Resource Blocks Bandwidth"

The sampling rate and the occupied bandwidth are determined by the parameter "Number of Resource Blocks Per Slot". If necessary, adjust the value of "FFT Size".

See also [Table 2-1](#).

Remote command:

[:SOURce<hw>] :BB:EUTRa:DL:NORB on page 585

FFT Size

Sets the FFT (Fast Fourier Transformation) size.

You can change the FFT size for all bandwidth definitions if the following conditions are met:

- For a specific bandwidth, all FFT sizes are applicable as long as the size is greater than the number of occupied subcarriers.
By default, the smallest available FFT size is selected.
- To decrease the number of unused guard subcarriers and the resulting sampling rate, for channel bandwidth of 15 MHz an FFT size of 1536 is provided, too.

Remote command:

[:SOURce<hw>] :BB:EUTRa:DL:FFT on page 585

Number of eMTC Narrowbands

Option: R&S SMM-K115

This parameter is **dedicated to eMTC** and available if "Mode > eMTC/NB-IoT or LTE/eMTC/NB-IoT" is selected.

It indicates amount of eMTC narrowbands N_{RB}^{DL} available within the selected channel bandwidth.

The value is calculated as follows:

"Number of Narrowbands" = "Number of Resource Blocks" / 6

For more information, see ["Narrowbands"](#) on page 332.

Remote command:

[:SOURCE<hw>] :BB:EUTRa:DL:EMTC:NNBands? on page 823

Number of eMTC Widebands

Option: R&S SMM-K143

This parameter is **dedicated to eMTC** and available if "Mode > eMTC/NB-IoT or LTE/eMTC/NB-IoT" and [Wideband Config](#) > "5 MHz/20 MHz" is selected.

It indicates the number of eMTC widebands N_{WB} available within the selected channel bandwidth.

The value is calculated as follows:

"Number of Widebands" = "Channel Bandwidth" / [Wideband Config](#)

For more information, see ["Widebands"](#) on page 333.

Remote command:

[:SOURCE<hw>] :BB:EUTRa:DL:EMTC:NWBands? on page 824

Wideband Config

Option: R&S SMM-K143

This parameter is **dedicated to eMTC** and available if "Mode > eMTC/NB-IoT or LTE/eMTC/NB-IoT" is selected.

If enabled, the available channel bandwidth is split into eMTC widebands with the selected bandwidth. The resulting number of widebands is indicated by the parameter [Number of eMTC Widebands](#).

For more information, see ["Widebands"](#) on page 333.

Remote command:

[:SOURCE<hw>] :BB:EUTRa:DL:EMTC:WBCFg on page 823

Physical Resource Block Bandwidth

Displays the bandwidth of one physical resource block. The value is fixed to 12 x 15 kHz.

Remote command:

n.a.

Occupied Bandwidth

Displays the occupied bandwidth, calculated from the parameter "Number of Resource Blocks Per Slot".

Remote command:

[:SOURCE<hw>] :BB:EUTRa:DL:OCCBandwidth? on page 586

Sampling Rate

Displays the sampling rate, calculated from the parameter "Number of Resource Blocks Per Slot".

Remote command:

[:SOURCE<hw>] :BB:EUTRa:DL:SRATE? on page 585

Number Of Occupied Subcarriers

Displays the number of occupied subcarriers, calculated from the parameter "Number of Resource Blocks Per Slot".

Remote command:

[:SOURCE<hw>] :BB:EUTRa:DL:OCCSubcarriers? on page 586

Number Of Left/Right Guard Subcarriers

Displays the number of left/right guard subcarriers, calculated from the parameter "Number of Resource Blocks Per Slot".

Remote command:

[:SOURCE<hw>] :BB:EUTRa:DL:LGS? on page 586

[:SOURCE<hw>] :BB:EUTRa:DL:RGS? on page 586

4.2.5 Cell-specific settings

Access:

1. Select "General > Link Direction > Downlink (OFDMA)".
2. Select "General DL Settings > Cell".

EUTRA/LTE A: General DL Settings								
Scheduling <i>Manual</i>	CA	MBSFN	Physical/TDD 10 MHz, UL/DL 0	Cell	Signals	Antenna Ports 1 TxAntenna		
Cell ID				0	Physical Cell ID Group	0	Physical Layer ID	0
Cyclic Prefix				Normal	UL Cyclic Prefix		Normal	
PDSCH P_B				0	PDSCH Ratio rho_B/rho_A		0.000 dB	
PDCCH Ratio rho_B/rho_A				0.000 dB	PBCH Ratio rho_B/rho_A		0.000 dB	
PHICH N_g				1/6	PHICH Duration		Normal	
RA_RNTI				1				

The "Cell-Specific Settings" section comprises the physical layer cell identity settings and the DL power control settings.

The TDD settings are available only, if the TDD is selected as a duplexing mode. The TDD frame is configured by adjusting the UL/DL configuration and the special subframe configuration.

Cell ID.....	97
Physical Cell ID Group.....	97
Physical Layer ID.....	97
Cyclic Prefix (General DL Settings).....	98
UL/DL Cyclic Prefix.....	98
PDSCH P_B.....	98
PDSCH/PDCCH/PBCH Ratio rho_B/rho_A.....	98
PHICH Duration.....	99
PHICH N_g.....	99
RA_RNTI.....	100

Cell ID

Sets the cell identity.

There are 504 unique physical layer cell identities (Cell ID), grouped into 168 unique physical cell identity groups that contain three unique identities each. The Cell ID is calculated as following:

$$\text{Cell ID} = 3 * \text{Physical Cell ID Group} + \text{Physical Layer ID}$$

There is a cross-reference between the values of these three parameters and changing of one of them results in adjustment in the values of the others.

The Cell ID determinates:

- The downlink reference signal pseudo-random sequence
- The frequency shifts of the reference signal
- The S-SYNC sequence
- The cyclic shifts for PCFICH, PHICH and PDCCH mapping
- The pseudo-random sequence used for scrambling

Remote command:

`[:SOURCE<hw>] :BB:EUTRa:DL [:PLCI] :CID` on page 587

Physical Cell ID Group

Sets the physical cell identity group.

To configure these identities within a cell ID group, set the parameter [Physical Layer ID](#).

Remote command:

`[:SOURCE<hw>] :BB:EUTRa:DL [:PLCI] :CIDGroup` on page 587

Physical Layer ID

Sets the identity of the physical layer within the selected physical cell identity group, set with parameter [Physical Cell ID Group](#).

The physical layer ID determinates the Zadoff-Chu orthogonal sequence carried by the PSS (P-SYNC) and used for cell search.

Remote command:

`[:SOURCE<hw>] :BB:EUTRa:DL [:PLCI] :PLID` on page 587

Cyclic Prefix (General DL Settings)

Sets the cyclic prefix length for all subframes.

The number of the OFDM symbols is set automatically.

- "Normal" Normal cyclic prefix, i.e. the DL slot contains seven OFDM symbols.
- "Extended" Extended cyclic prefix, i.e. the DL slot contains six OFDM symbols. The extended cyclic prefix is defined to cover large cell scenarios with higher delay spread and MBMS transmission. NB-IoT allocations cannot be activated.
- "User Defined" To set the cyclic prefix length per subframe, use the parameter "DL Frame Configuration" > "Cyclic Prefix".

Remote command:

[:SOURce<hw>] :BB:EUTRa:DL:CPC on page 588

UL/DL Cyclic Prefix

In "Duplexing > TDD", determines the cyclic prefix for the appropriate opposite direction.

Remote command:

[:SOURce<hw>] :BB:EUTRa:UL:DLCPc on page 596

[:SOURce<hw>] :BB:EUTRa:DL:ULCPc on page 588

PDSCH P_B

Defines the cell-specific ratio ρ_B/ρ_A according to TS 36.213 (Table 5.2-1).

The following table gives an overview of the resulting values of the parameter "PDSCH Ratio ρ_B/ρ_A " as function of the values for the parameter [PDSCH P_B] and the number of configured antennas.

PDSCH P_B	1 Tx antenna	2 or 4 Tx antennas
0	0.000 dB	0.969 dB
1	-0.969 dB	0.000 dB
2	-2.218 dB	-1.249 dB
3	-3.979 dB	-3.010 dB

Remote command:

[:SOURce<hw>] :BB:EUTRa:DL:PDSCh:PB on page 588

PDSCH/PDCCH/PBCH Ratio ρ_B/ρ_A

Displays or sets the transmit energy ratio among the resource elements allocated for PDSCH/PDCCH/PBCH in the OFDM symbols containing reference signal (P_B) and such not containing one (P_A).

The PDSCH value is calculated from the parameter PDSCH P_B. It also depends on the number of configured antennas.

Remote command:

[:SOURce<hw>] :BB:EUTRa:DL:PDSCh:RATBa on page 589

[:SOURce<hw>] :BB:EUTRa:DL:PDCCh:RATBa on page 589

[:SOURce<hw>] :BB:EUTRa:DL:PBCH:RATBa on page 589

PHICH Duration

Sets the PHICH duration, i.e. the allocation of the PHICH resource element groups over the OFDM symbols.

The value selected puts the lower limit of the size of the [PCFICH settings](#) that is signaled by the PCFICH.

If [Activate Carrier Aggregation](#) > "On", you can define the PHICH duration per component carrier.

- "Normal" All resources element groups of PHICH (see [Number of PHICH Groups](#)) are allocated on the first OFDM symbol (OFDM Symbol 0).
- "Extended" The resources element groups of PHICH are distributed over three OFDM symbols for a normal subframe or over two symbols within a special one.

Remote command:

[:SOURce<hw>] :BB:EUTRa:DL:CA:CELL<ch0>:PHICH:DURation on page 629

PHICH N_g

Sets the parameter N_g according to [TS 36.211](#), section 6.9.

If [Activate Carrier Aggregation](#) > "On", you can define the PHICH duration per component carrier.

- "1/6, 1/2, 1, 2" The used [Number of PHICH Groups](#) for the different subframes is calculated according to the following formula:

$$N_{PHICH}^{group} = \begin{cases} \lfloor N_g(N_{RB}^{DL}/8) \rfloor & \text{for normal cyclic prefix} \\ \lfloor 2 \cdot N_g(N_{RB}^{DL}/8) \rfloor & \text{for extended cyclic prefix} \end{cases}$$

In FDD mode, the calculated value corresponds directly to the parameter "Number of PHICH Groups".

In TDD mode, the number of PHICH groups is calculated as the product of the N_{PHICH}^{group} value multiplied with a coefficient selected from the following table.

UL/DL Configuration	Subframe number									
	0	1	2	3	4	5	6	7	8	9
0	2	1	-	-	-	2	1	-	-	-
1	0	1	-	-	1	0	1	-	-	1
2	0	0	-	1	0	0	0	-	1	0
3	1	0	-	-	-	0	0	0	1	1
4	0	0	-	-	0	0	0	0	1	1
5	0	0	-	0	0	0	0	0	1	0
6	1	1	-	-	-	1	1	-	-	1

The parameter [Number of PHICH Groups](#) is read-only.

- "Custom" (for [Activate Carrier Aggregation](#) > "Off")
The parameter [Number of PHICH Groups](#) is configurable.

Remote command:

[:SOURCE<hw>] :BB:EUTRa:DL:CA:CELL<ch0>:PHICh:NGParameter
on page 629

RA_RNTI

Sets the random-access response identity RA-RNTI for the users.

The value selected here determined the value of the parameter [UE_ID/n_RNTI](#) in case a RA_RNTI "User" is selected.

See [UE_ID/n_RNTI](#).

Remote command:

[:SOURCE<hw>] :BB:EUTRa:DL:CSEttings:RARnti on page 588

4.2.6 TDD frame structure settings

Access:

- ▶ Select "EUTRA/LTE > Duplexing > TDD".

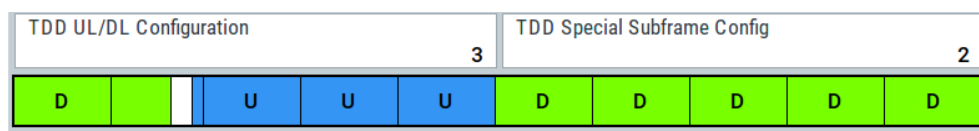

The TDD frame is configured by adjusting the UL/DL configuration and the special subframe configuration (see also [Chapter 2.2.1.1, "OFDMA parameterization"](#), on page 19).

TDD UL/DL Configuration

Sets the UL/DL configuration number and defines which subframe is used for downlink respectively uplink, and where the special subframes are located.

Remote command:

[:SOURCE<hw>] :BB:EUTRa:TDD:UDConf on page 579

TDD Special Subframe Config

Sets the special subframe configuration number and together with the parameter "Cyclic Prefix" defines the lengths of the DwPTS, the guard period (GP) and the UpPTS.

The DwPTS length selected with this parameter determines the maximum number of the OFDM symbols available for PDSCH in the special subframe.

The UpPTS length selected with this parameter determines the maximum number of the SC-FDMA symbols available for SRS in the special subframe.

Remote command:

[:SOURCE<hw>] :BB:EUTRa:TDD:SPSConf on page 578

Number of UpPTS Symbols

Option: R&S SMM-K119 (if "Mode = LTE")

Option: R&S SMM-K143 (if "Mode = eMTC/NB-LoT")

For [TDD Special Subframe Config](#) = 10, sets the number of UpPTS symbols.

In all other configurations, the number of UpPTS symbols is set automatically depending on:

- ["TDD UL/DL Configuration"](#) on page 100
- ["TDD Special Subframe Config"](#) on page 100.

Remote command:

[:SOURce<hw>] :BB:EUTRa:TDD:UPTS on page 579

4.2.7 Downlink signals settings

Access:

1. Select "General > Link Direction > Downlink (OFDMA)".
2. Select "General DL Settings > Signals".

The "Signals" dialog comprises the settings of all DL signals.

- [Synchronization and cell-specific reference signals \(CRS/SYNC\) settings](#)..... 101
- [NB-LoT synchronization and cell-specific reference signals \(NRS/N-SYNC\) settings](#) 103
- [Positioning reference signal \(PRS\) settings](#)..... 104
- [CSI-RS settings](#)..... 108
- [Discovery reference signals \(DRS\) settings](#)..... 115
- [Narrowband positioning reference signals \(NPRS\) settings](#)..... 120
- [NB-LoT wake-up signal \(NWUS\) settings](#)..... 123

4.2.7.1 Synchronization and cell-specific reference signals (CRS/SYNC) settings

Access:

1. Select "General > Link Direction > Downlink (OFDMA)".

2. Select "General DL Settings > Signals > CRS/SYNC".

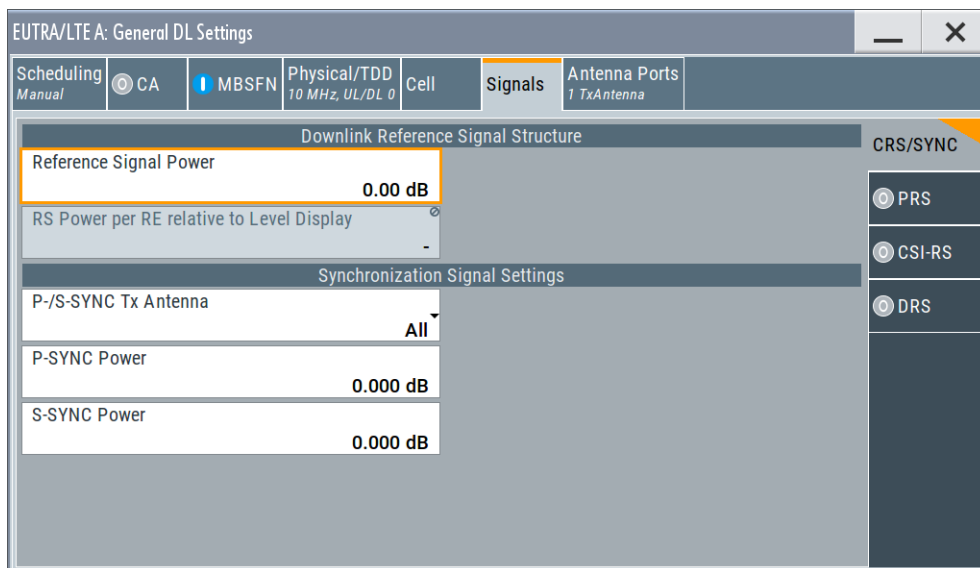

The dialog comprises the "Downlink Reference Signal Structure" and the "Synchronization Signal Settings" sections. Use these settings to set the power level of the reference signals and the P-/S-SYNC and to enable/disable the P-/S-SYNC.

Downlink Reference Signal Structure

Comprises the downlink reference signal settings, like the power of the reference signals.

For an overview of the provided power settings and detailed information on how to adjust them, refer to [Chapter 9.3, "Adjusting the signal power"](#), on page 539.

Reference Signal Power ← Downlink Reference Signal Structure

Sets the power of the reference signal (PRS relative).

Remote command:

`[:SOURCE<hw>] :BB:EUTRa:DL:REFSig:POWer` on page 583

RS Power per RE relative to Level Display ← Downlink Reference Signal Structure

If "EUTRA/LTE > State = On", displays the power of the reference signal (RS) per resource element (RE) relative to the power value, displayed in the status bar ("Level").

If a MIMO configuration is enabled, the value of this parameter is equal for all antennas; this applies also for the antenna configured in the path B.

Remote command:

`[:SOURCE<hw>] :BB:EUTRa:DL:REFSig:EPRE?` on page 583

Synchronization Signal Settings

In the "Synchronization Signal Settings" section, the power of the P-SYNC/S-SYNC is set.

P-/S-SYNC Tx Antenna ← Synchronization Signal Settings

Defines on which antenna port the P-/S-SYNC is transmitted.

The available values depend on the number of configured antennas.

Remote command:

[:SOURce<hw>] :BB:EUTRa:DL:SYNC:TXAntenna on page 584

P-SYNC Power ← Synchronization Signal Settings

Sets the power of the P-SYNC allocations.

Remote command:

[:SOURce<hw>] :BB:EUTRa:DL:SYNC:PPOwer on page 584

S-SYNC Power ← Synchronization Signal Settings

Sets the power of the S-SYNC allocations.

Remote command:

[:SOURce<hw>] :BB:EUTRa:DL:SYNC:SPOwer on page 584

4.2.7.2 NB-IoT synchronization and cell-specific reference signals (NRS/N-SYNC) settings

Option: R&S SMM-K115

Access:

1. Select "Mode > LTE/eMTC/NB-IoT"
2. Select "General > Link Direction > Downlink (OFDMA)".
3. Select "General DL Settings > Physical > Channel Bandwidth \geq 1.4 MHz"
4. Select "General DL Settings > Signals > NRS/N-SYNC".

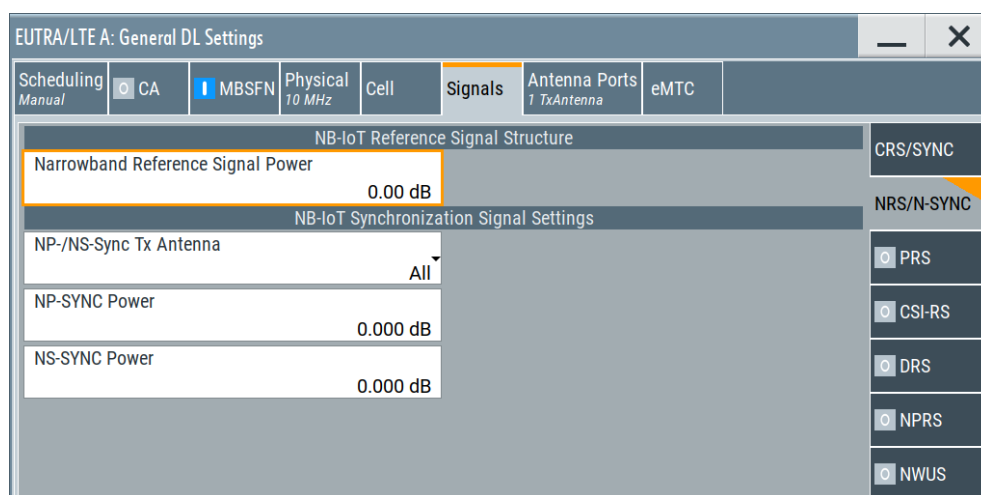
**NRS/N-SYNC (NPSS/NSSS)**

Option:R&S SMM-K115

Access: "General DL Settings > Physical > Channel Bandwidth \geq 3 MHz" and "Signals > NRS/N-SYNC".

Comprises the NB-IoT Signals NRS and NPSS/NSSS settings.

Narrowband Reference Signal Power ← NRS/N-SYNC (NPSS/NSSS)

Sets the power of the narrowband reference signal (NRS).

Remote command:

[:SOURCE<hw>] :BB:EUTRa:DL:REFSig:NIOT:POWer on page 824

NP-/NS-Sync Tx Antenna ← NRS/N-SYNC (NPSS/NSSS)

Defines on which antenna port the NPSS/NSSS are transmitted.

The available values depend on the number of configured antennas, see [NB-IoT MIMO Configuration](#).

Remote command:

[:SOURCE<hw>] :BB:EUTRa:DL:SYNC:NIOT:TXAntenna on page 824

NP-SYNC Power/NS-SYNC Power ← NRS/N-SYNC (NPSS/NSSS)

Sets the power of the NPSS/NSSS allocations.

Remote command:

[:SOURCE<hw>] :BB:EUTRa:DL:SYNC:NIOT:NPPWr on page 825

[:SOURCE<hw>] :BB:EUTRa:DL:SYNC:NIOT:NSPWr on page 825

4.2.7.3 Positioning reference signal (PRS) settings

Option: R&S SMM-K84.

Access:

1. Select "General > Link Direction > Downlink (OFDMA)".
2. Select "General DL Settings > Signals > PRS".

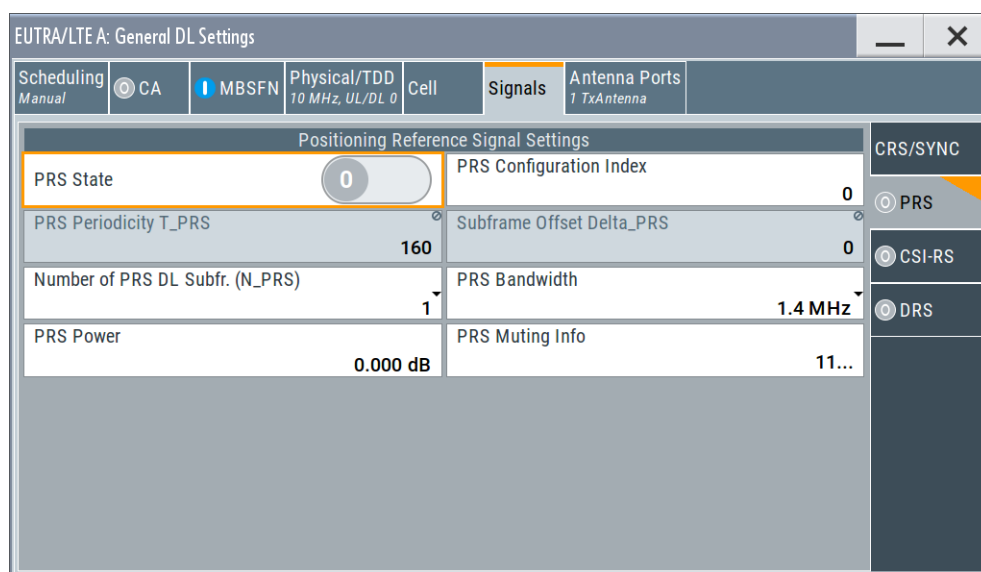

This section comprises the setting necessary to configure the positioning reference signals (PRS). See also "[Positioning reference signals](#)" on page 30.



If PRS and MBSFN are configured to be in the same subframe, MBSFN is skipped and PRS is transmitted solely.

If a PDSCH is configured to overlap partially with the PRS bandwidth in a PRS subframe, the PRS in these resource blocks is skipped then.

Example: Overlapping PDSCH, PRS and MBSFN

Perform the following settings:

- [PRS State](#) = ON
- [PRS Configuration Index](#) = 0
- [Number of PRS DL Subframes \(N_PRS\)](#) = 2
- [PRS Bandwidth](#) = 3 MHz
- [MBSFN Mode](#) = Mixed
- Use the [OFDMA time plan](#) to visualize the allocation of the PRSs.

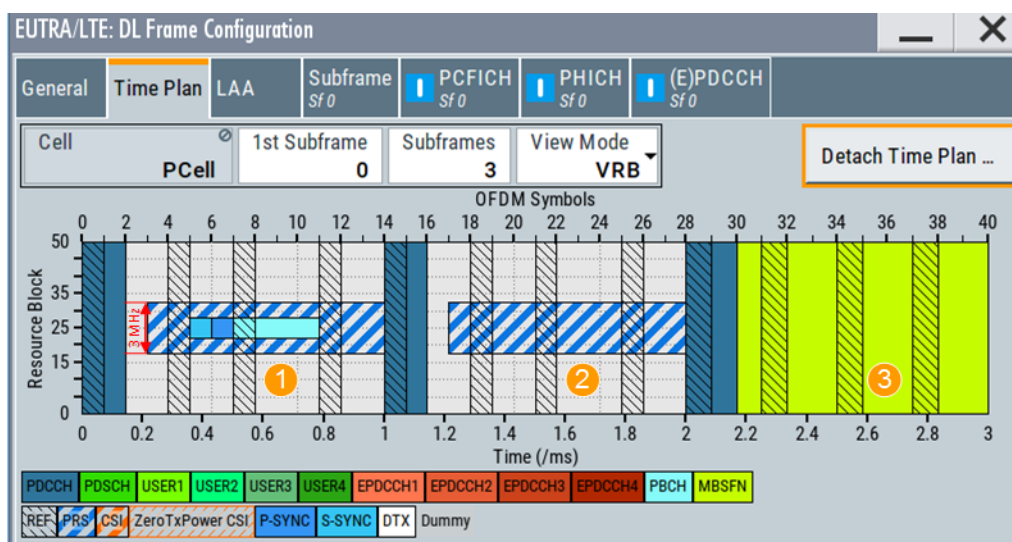

- 1 = PDSCH and PRS are overlapping in the subframe#0
- 2 = MBSFN is ignored in subframe#1
- 1+2 = two consequent PRS subframes with 3 MHz Bandwidth, i.e. one PRS occasion
- 3 = first MBSFN subframe

Example: How to visualize the effect of muting and omitting PRS transmission

Perform the following settings:

- Select "EUTRA/LTE > General DL Settings > Physical > Channel Bandwidth = 3 MHz"
- Select "EUTRA/LTE > DL Frame Configuration > Subframe Config" and configure the subframes.
- Select "EUTRA/LTE > General DL Settings > Signals > PRS", use the default settings, and enable the following:

- "PRS Configuration Index = 1"
 - "Number of PRS DL Subframes (N_PRS) = 2"
 - "PRS State > On"
 - Select "EUTRA/LTE > General DL Settings" and open the [OFDMA time plan](#) to visualize the configured allocations.
- Tip:** Select "Show Time Plan in Dialog" to easy switch between dialogs with settings and the time plan.

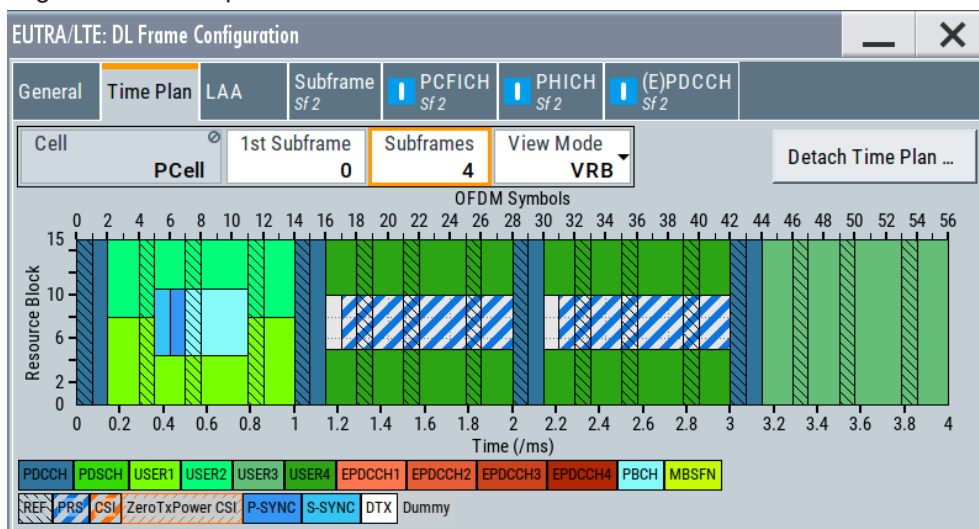

The time plan confirms the transmission of one PRS occasion, consisting of two consequent PRS subframes with 1.4 MHz bandwidth, transmitted in subframe#1 and subframe#2.

- Select "EUTRA/LTE > DL Frame Configuration > Behavior in Unsch. RE (OCGN) > Dummy Data"
- Select "EUTRA/LTE > DL Frame Configuration > Dummy Data Configuration > Omit PRS Subframes"
- Observe the allocations displayed on the time plan.
The time plan confirms that the PRS subframes are *not* filled in with DTX.
- Select "EUTRA/LTE > General DL Settings > PRS" and set "PRS Muting Info = 01"
- Observe the allocations displayed on the time plan.

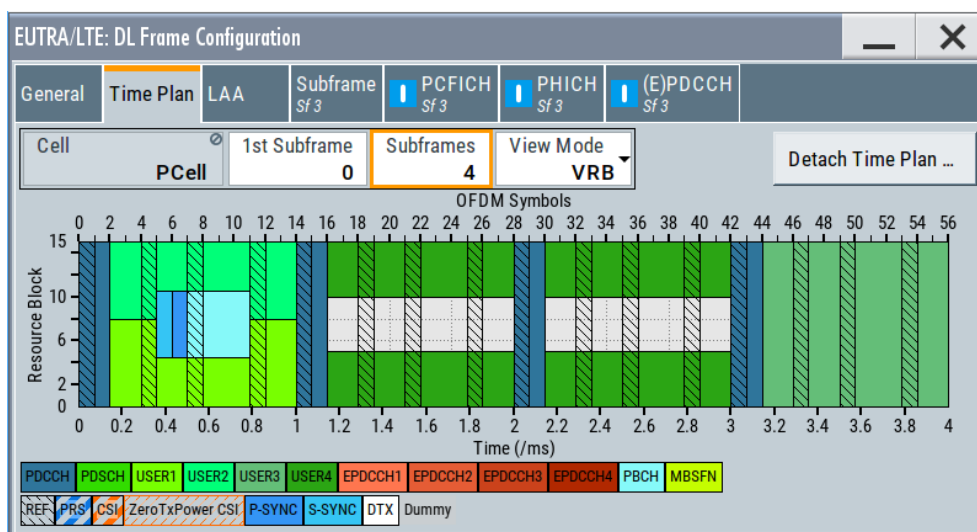

The time plan confirms that the PRS is muted; there is no transmission of PRS in the subframe#1 and subframe#2. The muted PRS subframes are not omitted; the allocation-free resource blocks in these subframes are filled with DTX.

PRS State..... 107
 PRS Configuration Index..... 107
 PRS Periodicity T_PRS..... 107
 PRS Subframe offset Delta_PRS..... 107
 Number of PRS DL Subframes (N_PRS)..... 108
 PRS Bandwidth..... 108
 PRS Power..... 108
 PRS Muting Info..... 108

PRS State

Enables the generation of the PRS.

Remote command:

```
[ :SOURCE<hw> ] :BB:EUTRa:DL:PRSS:STATE on page 591
```

PRS Configuration Index

Sets the PRS Configuration Index I_{PRS} as defined in TS 36.211 (table 6.10.4.3-1).

Remote command:

```
[ :SOURCE<hw> ] :BB:EUTRa:DL:PRSS:CI on page 589
```

PRS Periodicity T_PRS

Displays the periodicity of the PRS generation (T_{PRS}) as defined in TS 36.211 (table 6.10.4.3-1).

Remote command:

```
[ :SOURCE<hw> ] :BB:EUTRa:DL:PRSS:TPRS? on page 591
```

PRS Subframe offset Delta_PRS

Displays the subframe offset of the PRS generation (Δ_{PRS}) as defined in TS 36.211 (table 6.10.4.3-1).

Remote command:

[:SOURCE<hw>] :BB:EUTRa:DL:PRSS:DPRS? on page 590

Number of PRS DL Subframes (N_PRS)

Defines the number of consecutive DL subframes in that PRS are transmitted. Several consecutive DL subframes build one PRS occasion.

Remote command:

[:SOURCE<hw>] :BB:EUTRa:DL:PRSS:NPRS on page 590

PRS Bandwidth

Defines the RBs in which the PRS is transmitted.

Note: The PRS Bandwidth must not be bigger than channel bandwidth.

Remote command:

[:SOURCE<hw>] :BB:EUTRa:DL:PRSS:BW on page 589

PRS Power

Sets the power of a PRS resource element relative to the power of a common reference signal resource element.

Remote command:

[:SOURCE<hw>] :BB:EUTRa:DL:PRSS:POW on page 590

PRS Muting Info

Specifies a bit pattern that defines the muted and not muted PRS. The bit pattern can be 2, 4, 8 or 16 bit long, where each bit defines the PRS state of one PRS occasion. The parameter [Number of PRS DL Subframes \(N_PRS\)](#) defines the length of the PRS occasions.

See [Example"How to visualize the effect of muting and omitting PRS transmission"](#) on page 105

"0" PRS is muted in the corresponding PRS occasion.

"1" PRS is not muted, i.e. PRS is transmitted in the corresponding PRS occasion.

Remote command:

[:SOURCE<hw>] :BB:EUTRa:DL:PRSS:MIPattern on page 591

4.2.7.4 CSI-RS settings

Access:

1. Select "General > Link Direction > Downlink (OFDMA)".
2. Select "General DL Settings > Signals > CSI".

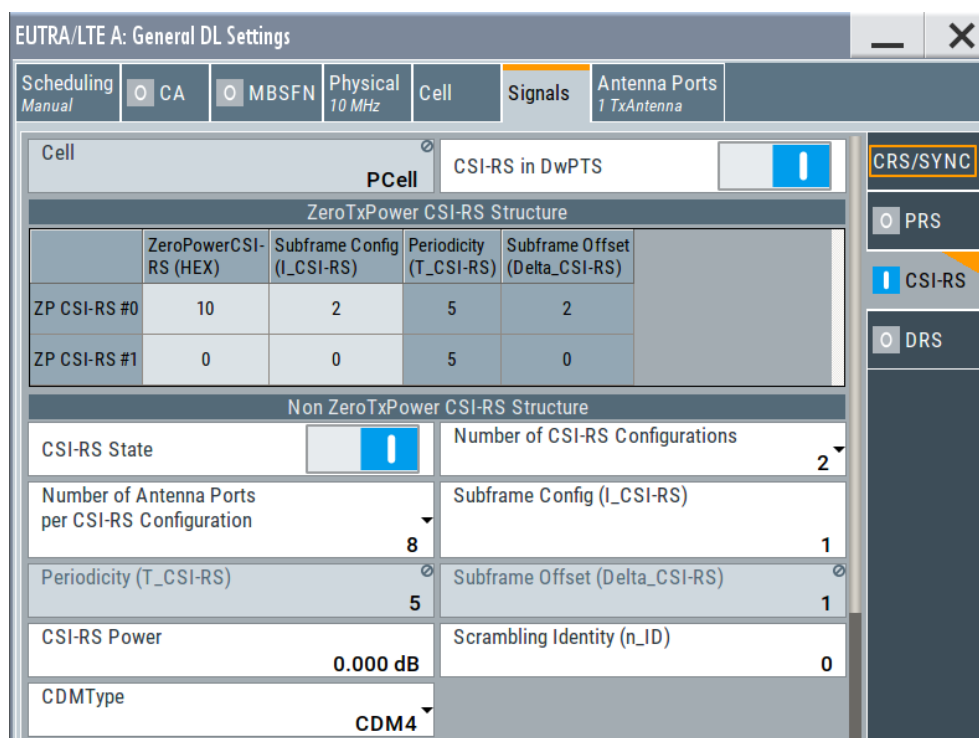

This dialog comprises the settings for configuring the channel-state information reference signal (CSI-RS) structure. For detailed information, see "CSI reference signals" on page 31.

The TS 36.211 specifies the occurrence of the CSI reference signal in the subframes as function of the subframe configuration period $T_{\text{CSI-RS}}$ and the subframe offset $\text{Delta}_{\text{CSI-RS}}$. The available value ranges are listed in Table 4-3 [TS 36.211]. The parameter $l_{\text{CSI-RS}}$ can be configured separately for the zero (ZeroTxPower CSI-RS Structure) and non-zero transmission power ("NonZeroTxPower CSI-RS Structure" on page 112) cases.

Table 4-3: CSI reference signal structure configuration

CSI-RS subframe configuration $l_{\text{CSI-RS}}$	CSI-RS periodicity $T_{\text{CSI-RS}}$ (subframes)	CSI-RS subframe offset $\text{Delta}_{\text{CSI-RS}}$ (subframes)
0 to 4	5	$l_{\text{CSI-RS}}$
5 to 14	10	$l_{\text{CSI-RS}} - 5$
15 to 34	20	$l_{\text{CSI-RS}} - 15$
35 to 74	40	$l_{\text{CSI-RS}} - 35$
75 to 154	80	$l_{\text{CSI-RS}} - 75$

How to enable and visualize a CSI-RS transmission

1. Select "EUTRA/LTE > Set to Default".

2. Select "EUTRA/LTE > Link Direction > Downlink (OFDMA)".
3. Select "EUTRA/LTE > State > On".
4. Select "EUTRA/LTE > General Downlink Settings".
5. Select "General Downlink Settings > Signals > CSI-RS".
Configure the settings as required.
For example, enable the settings displayed in the figure above.
6. Enable "Cell-specific CSI-RS Structure > Subframe Config (I_CSI-RS) = 1".
7. Select "Cell-specific CSI-RS Structure > CSI-RS State > On".
Close the dialog.
8. Select "EUTRA/LTE > Frame Configuration".
9. LAA is disabled in this example. If LAA is configured and thus "Scheduling > PDSCH Scheduling = Auto/DCI" is used, the "Subframe" settings are automatically configured. To observe the allocation of the physical resources, open the time plan (see [step 10](#)). Otherwise proceed as follows:
Configure the subframe selected for the CSI-RS transmission:
 - a) Select "Frame Configuration > Subframe > Subframe Selection = 1" to configure the subframe selected for the CSI-RS transmission.
 - b) Set "No. of Used Allocations = 2".
The allocation table displays the activated PDSCH allocation with the corresponding number of used "Phys. Bits".
 - c) In the allocation table, for this PDSCH allocation, select "Ench. Settings > Config".
 - d) In the "Enhanced Settings" dialog, select "CSI-RS > Awareness > On".
 - e) In the allocation table, select the PDSCH allocation. Compare the number of used "Phys. Bits".

The displayed information confirms, that less physical bits are allocated for the PDSCH, because some resources are reserved for the CSI-RS transmission.

Tip: Use the parameter [CSI Awareness State](#) to inform an UE that a CSI-RS transmission is used.
10. Select "Frame Configuration > Time Plan".
Set "No of Subframes = 10".

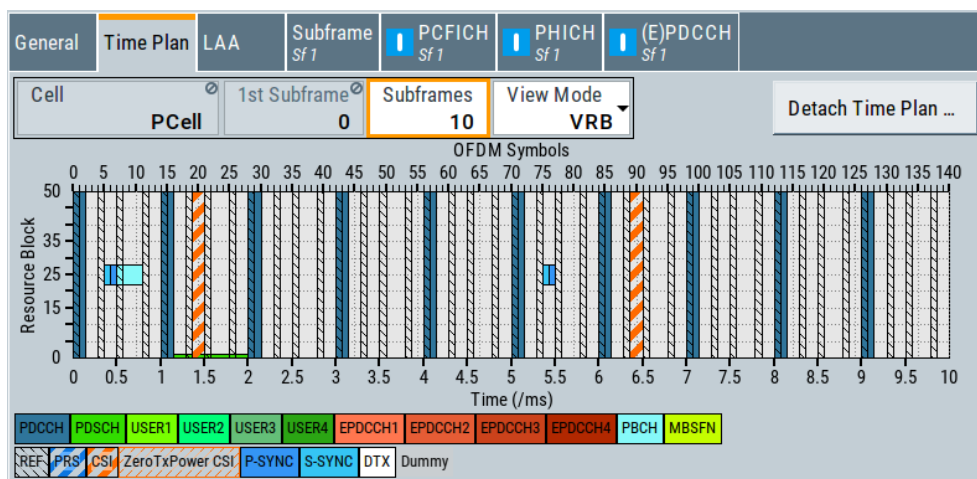

- Cell..... 111
- CSI-RS in DwPTS..... 111
- ZeroTxPower CSI-RS Structure..... 112
 - L ZeroPowerCSI-RS (HEX)..... 112
 - L Subframe Config (I_CSI-RS)..... 112
 - L Periodicity (T_CSI-RS)..... 112
 - L Subframe Offset (Delta_CSI-RS)..... 112
- NonZeroTxPower CSI-RS Structure..... 112
 - L CSI-RS State..... 112
 - L Number of CSI-RS Configurations..... 112
 - L Number of AP per CSI-RS Configuration..... 113
 - L Subframe Config (I_CSI-RS)..... 113
 - L Periodicity (T_CSI-RS)..... 113
 - L Subframe Offset (Delta_CSI-RS)..... 113
 - L CSI-RS Power..... 113
 - L Scrambling Identity (n_ID)..... 113
 - L CDMType..... 114
 - L CSI-RS Configurations..... 114
 - L CSI-RS Configuration #..... 114
 - L Resource Configuration..... 114
 - L Frequency Density..... 114
 - L Transmission Comb..... 115

Cell

With enabled "General DL Settings > CA > Activate Carrier Aggregation > On" state, indicates to which cell (i.e. component carrier) the settings apply.

Remote command:

n.a

CSI-RS in DwPTS

Enables transmission of the CSI-RS in the Downlink Pilot Time Slot (DwPTS) parts of the TDD frame.

Remote command:

[:SOURce<hw>] :BB:EUTRa:DL:CSIS [:CELL<ch0>] :DWPTs on page 634

ZeroTxPower CSI-RS Structure

Option: R&S SMM-K113

From LTE Rel. 12 on, eNBs support one (ZP CSI-RS #0) primary and one additional (ZP CSI-RS #1) zero-power CSI reference signal for each cell.

ZeroPowerCSI-RS (HEX) ← ZeroTxPower CSI-RS Structure

Sets the used CSI-RS configurations in the zero transmission power subframes.

Required is a 16-bit-long hexadecimal value (bitmap). The UE assumes a zero transmission power for each bit set to one.

Remote command:

```
[ :SOURCE<hw> ] :BB:EUTRa:DL:CSIS [ :CELL<ch0> ] [ :ZPRS<st0> ] :ZP
```

on page 633

Subframe Config (I_CSI-RS) ← ZeroTxPower CSI-RS Structure

Sets the parameter $I_{\text{CSI-RS}}$ for CSI-RS with zero transmission power, see [Table 4-3](#).

Remote command:

```
[ :SOURCE<hw> ] :BB:EUTRa:DL:CSIS [ :CELL<ch0> ] [ :ZPRS<st0> ] :ZPI
```

on page 634

Periodicity (T_CSI-RS) ← ZeroTxPower CSI-RS Structure

Sets the parameter subframe configuration period $T_{\text{CSI-RS}}$ for CSI-RS with zero transmission power, see [Table 4-3](#).

Remote command:

```
[ :SOURCE<hw> ] :BB:EUTRa:DL:CSIS [ :CELL<ch0> ] [ :ZPRS<st0> ] :ZPT?
```

on page 634

Subframe Offset (Delta_CSI-RS) ← ZeroTxPower CSI-RS Structure

Sets the parameter subframe offset $\Delta_{\text{CSI-RS}}$ for CSI-RS with zero transmission power, see [Table 4-3](#).

Remote command:

```
[ :SOURCE<hw> ] :BB:EUTRa:DL:CSIS [ :CELL<ch0> ] [ :ZPRS<st0> ] :ZPDelta?
```

on page 633

NonZeroTxPower CSI-RS Structure

Comprises the following cell-specific parameters:

CSI-RS State ← NonZeroTxPower CSI-RS Structure

Enables the transmission of a CSI-RS, see also "[How to enable and visualize a CSI-RS transmission](#)" on page 109.

Remote command:

```
[ :SOURCE<hw> ] :BB:EUTRa:DL:CSIS [ :CELL<ch0> ] :STATE on page 632
```

Number of CSI-RS Configurations ← NonZeroTxPower CSI-RS Structure

Option: R&S SMM-K119

Enables using multiple CSI-RS configurations and sets the value of the parameter

$N_{\text{res}}^{\text{CSI}}$.

To define the individual configurations, use the parameters [Resource Configuration](#), [Frequency Density](#) and [Transmission Comb](#).

See also [Chapter 2.2.8.4, "Full dimension MIMO \(FD-MIMO\)"](#), on page 57.

Remote command:

[:SOURCE<hw>] :BB:EUTRa:DL:CSIS [:CELL<ch0>] :NCFG on page 635

Number of AP per CSI-RS Configuration ← NonZeroTxPower CSI-RS Structure

Defines (or indicates) the number of antenna ports (one, two, four or eight) the CSI-RS are transmitted on.

Option: R&S SMM-K119

- This field is configured automatically, if [Number of CSI-RS Configurations](#) ≥ 2 is selected.

The value indicates the number of antenna ports per CSI-RS configuration $N_{\text{ports}}^{\text{CSI}}$ and is selected to comply with the aggregation rule, given in [Table 2-8](#).

- The value displayed in the "DRS" > "CSI-RS" on page 118 dialog resembles the value set in the "CSI-RS" dialog.

Use the [Cell-Specific Antenna Port Mapping](#) and configure the cell-specific antenna port mapping.

Remote command:

[:SOURCE<hw>] :BB:EUTRa:DL:CSIS [:CELL<ch0>] :NAP on page 631

Subframe Config (I_CSI-RS) ← NonZeroTxPower CSI-RS Structure

Sets the parameter $I_{\text{CSI-RS}}$ for cell-specific CSI-RS, see [Table 4-3](#).

Remote command:

[:SOURCE<hw>] :BB:EUTRa:DL:CSIS [:CELL<ch0>] :SFI on page 632

Periodicity (T_CSI-RS) ← NonZeroTxPower CSI-RS Structure

Indicates the parameter subframe configuration period $T_{\text{CSI-RS}}$ for cell-specific CSI-RS, see [Table 4-3](#).

Remote command:

[:SOURCE<hw>] :BB:EUTRa:DL:CSIS [:CELL<ch0>] :SFT? on page 632

Subframe Offset (Delta_CSI-RS) ← NonZeroTxPower CSI-RS Structure

Indicates the parameter subframe offset $\Delta_{\text{CSI-RS}}$ for cell-specific CSI-RS, see [Table 4-3](#).

Remote command:

[:SOURCE<hw>] :BB:EUTRa:DL:CSIS [:CELL<ch0>] :SFDelta? on page 632

CSI-RS Power ← NonZeroTxPower CSI-RS Structure

Boosts the CSI-RS power compared to the cell-specific reference signals.

Remote command:

[:SOURCE<hw>] :BB:EUTRa:DL:CSIS [:CELL<ch0>] :POW on page 631

Scrambling Identity (n_ID) ← NonZeroTxPower CSI-RS Structure

Option: R&S SMM-K112

Sets the additional scrambling identity n_ID used to generate the NonZeroTxPower CSI-RS, as specified in LTE Rel. 11.

Remote command:

[:SOURCE<hw>] :BB:EUTRa:DL:CSIS [:CELL<ch0>] :SCID on page 635

CDMType ← NonZeroTxPower CSI-RS Structure

Option: R&S SMM-K119

Sets the higher-level parameter $CDMType$ that influence the antenna port mapping of the CSI-RS.

CDM8 type is available if the product of [Number of CSI-RS Configurations](#) * [Number of AP per CSI-RS Configuration](#) = {24 or 32}

See also [Chapter 2.2.8.4, "Full dimension MIMO \(FD-MIMO\)"](#), on page 57.

Remote command:

[:SOURCE<hw>] :BB:EUTRa:DL:CSIS [:CELL<ch0>] :CDMType on page 636

CSI-RS Configurations ← NonZeroTxPower CSI-RS Structure

Table with several rows, where the number of rows depends on the [Number of CSI-RS Configurations](#).

CSI-RS Configuration # ← CSI-RS Configurations ← NonZeroTxPower CSI-RS Structure

Option: R&S SMM-K119

Indicates the configuration number, where the number of configurations is set with [Number of CSI-RS Configurations](#).

Resource Configuration ← CSI-RS Configurations ← NonZeroTxPower CSI-RS Structure

Defines the CSI-RS configuration used for the current cell and for which the UE assumes non-zero transmission power. The zero transmission power subframes are determined by the [ZeroPowerCSI-RS \(HEX\)](#).

Option: R&S SMM-K119

From LTE Rel. 13 on, cells can use multiple CSI-RS configurations. Select [Number of CSI-RS Configurations](#) ≥ 2 to enable this feature and be able to select an individual CSI-RS configuration value for each of the enabled configurations.

The [Number of AP per CSI-RS Configuration](#) and the [CDMType](#) are set automatically. All other CSI-RS configuration settings are common for all CSI-RS configurations.

Remote command:

[:SOURCE<hw>] :BB:EUTRa:DL:CSIS [:CELL<ch0>] :CONFig [<st>]

on page 631

Frequency Density ← CSI-RS Configurations ← NonZeroTxPower CSI-RS Structure

Option: R&S SMM-K119

Sets the parameter $NZP-FrequencyDensity$ and thus defines the CSI-RS mapping to resource elements according to [TS 36.211](#).

Remote command:

```
[ :SOURce<hw> ] :BB:EUTRa:DL:CSIS [ :CELL<ch0> ] :FRDensity [<st>]
```

on page 636

Transmission Comb ← CSI-RS Configurations ← NonZeroTxPower CSI-RS Structure

Option: R&S SMM-K119

Sets the parameter `NZP-TransmissionComb` and thus defines the CSI-RS mapping to resource elements according to [TS 36.211](#).

Remote command:

```
[ :SOURce<hw> ] :BB:EUTRa:DL:CSIS [ :CELL<ch0> ] :TRANscomb [<st>]
```

on page 636

4.2.7.5 Discovery reference signals (DRS) settings

Option: R&S SMM-K119

Access:

1. Select "General > Link Direction > Downlink (OFDMA)".
2. Select "General DL Settings > Scheduling > PDSCH Scheduling" > **"Auto/DCI or Auto Sequence"**.
3. Select "General DL Settings > CA" > **"SCell"** > "Duplexing" > **"LAA"**.
4. Select "General DL Settings > Signals > DRS".

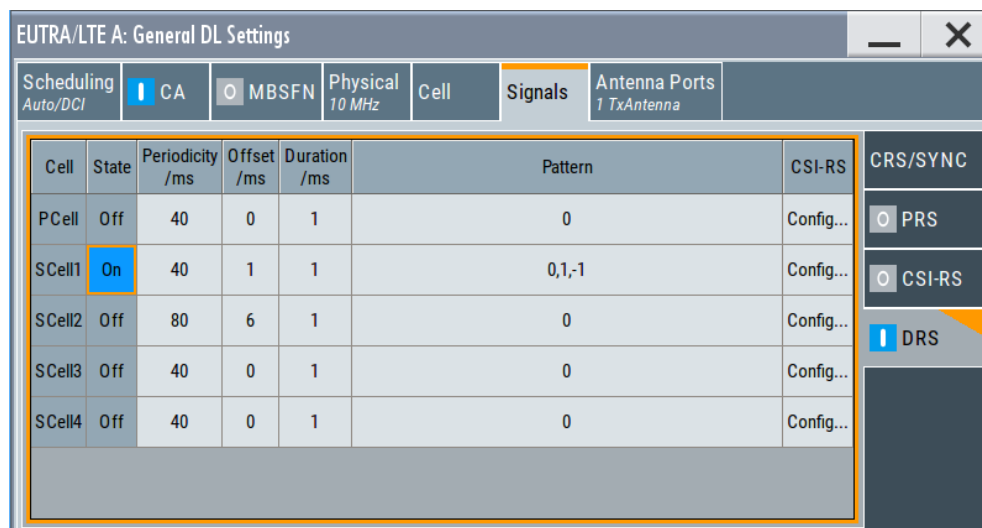

5. To access the CSI-RS settings, select "CSI-RS > Config".

EUTRA/LTE A: CSI...uration (SCell 1)

CSI-RS Part of DRS

ZeroTxPower CSI-RS Structure

Number of CSI-RS Configurations: 1

	ZeroPower CSI-RS	Subframe Config (I_CSI-RS)	Periodicity (T_CSI-RS)	Subframe Offset (Δ_CSI-RS)
1	4	1	5	1

NonZeroTxPower CSI-RS Structure

Number of CSI-RS Antenna Ports: 1

Number of CSI-RS Configurations: 2

	Scrambling Identity (n_ID)	CSI-RS Configuration	Subframe Offset with SSS	Q-Offset
1	1	2	0	-2
2	0	6	0	14

6. During a discovery signal occasion, the eNB can configure up to 5 zero-power CSI reference signals (CSI-RS) and up to 96 non-zero-power CSI reference signals within the DRS period.

To configure the CSI-RS:

- Set "CSI-RS Part of DRS = On"
- Set "ZeroTxPower/NonZeroTxPower > Number of CSI-RS Configurations ≥ 1 "
- Configure the CSI-RS structures as required.

This dialog comprises settings, necessary to configure the discovery reference signals occasions for the LAA cells.

For configuration of the LAA burst, see [Chapter 4.3.8, "LAA settings"](#), on page 158. See also ["Discovery reference signal \(DRS\)"](#) on page 56.

How to set the ARB sequence length for signals composed of DRSs with different periodicity

Per default, the R&S SMM100A uses an ARB sequence length of 1 frame. Thus the generated signal is 10 ms long and comprises the first LAA frame. This frame is then repeated cyclically.

If DRS signals with different periodicity are configured, you have to adjust the length of the generated signal so that it contains the whole DRS periodicity of all DRSs.

- Select "LTE > Filter/Clipping/ARB/TDW/Power Settings > ARB" to observe the current signal length.

2. Calculate the required ARB sequence length as follows:
"ARB Sequence Length" = $k * \text{LCM}(\text{"Periodicity"}_{\text{PCell}}, \text{"Periodicity"}_{\text{SCell\#1}}, \dots, \text{"Periodicity"}_{\text{SCell\#4}}) / 10$
Where:
 - k is a multiplier and $k \geq 1$
 - LCM is the standard least common multiple mathematical function
 - "Periodicity"_{PCell/SCell#n} is the DRS periodicity in milliseconds of each of the active cell with enabled DRS signals.
3. Set "ARB > ARB Sequence Length" to the calculated value.

Settings:

Cell.....	117
State.....	117
Periodicity.....	117
Offset.....	118
Duration.....	118
Pattern.....	118
CSI-RS.....	118
L CSI-RS Part of DRS.....	119
L ZeroTxPower/NonZeroTxPower CSI-RS Structure>Number of CSI-RS Configurations.....	119
L ZeroPower CSI-RS.....	119
L Subframe Config (I_CSI-RS).....	119
L Periodicity (T_CSI-RS).....	119
L Subframe Offset (Delta_CSI-RS).....	119
L Number of AP per CSI-RS Configuration.....	120
L Scrambling Identity (n_ID).....	120
L CSI-RS Configuration.....	120
L Subframe Offset with SSS.....	120
L Q-Offset.....	120

Cell

Indicates the cell (PCell or SCell) the displayed settings belong to.

Remote command:

n.a.

State

For LAA SCells, enables the selected discovery reference signal occasion configuration.

Remote command:

[:SOURCE<hw>] :BB:EUTRa:DL:DRS:CELL<ch0>:STATE on page 639

Periodicity

Defines how often the DRS measurement timing configuration (DMTC) occasion appears.

A DMTC occasion lasts 6 ms and can appear each 40 ms, 80 ms or 160 ms.

See also "Discovery reference signal (DRS)" on page 56.

Remote command:

[:SOURCE<hw>] :BB:EUTRa:DL:DRS:CELL<ch0>:PERiodicity on page 639

Offset

Offsets the DRS within the periodical DRS occasion, see [Figure 2-35](#).

Remote command:

[:SOURCE<hw>] :BB:EUTRa:DL:DRS:CELL<ch0>:OFFSet on page 639

Duration

Sets or indicates the DRS duration.

- For LAA SCells, "Duration = 1 ms"
- In FDD mode, "Duration = 2 to 5 ms"

Remote command:

[:SOURCE<hw>] :BB:EUTRa:DL:DRS:CELL<ch0>:DURation on page 640

Pattern

A DRS is 1ms long (see [Duration](#)) and is transmitted **zero times or at most once** in any subframe during the DMTC occasion.

For LAA SCells, this parameter defines the DRS subframes for 20 DMTC occasions.

The values are set as a sequence of up to 20 values within the range -1 to 5 and indicate the following situations:

- -1: no DRS transmission
- 0, 1, 2, 3, 4, 5: DRS transmitted in the first/second/third/fourth/sixth subframe of the DMTC occasion

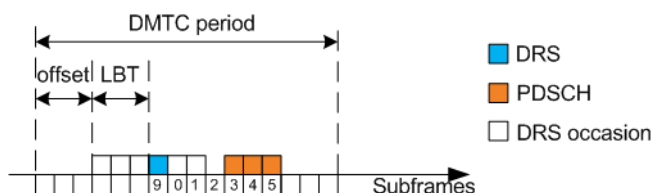

Figure 4-5: DRS allocation

DRS	= Discovery reference signal
LBT	= Listen-before-talk
DMTC	= DRS measurement timing configuration
DRS occasion	= Subframes during the DMTC period where DRS can occur
PDSCH	= Physical DL shared channel

Remote command:

[:SOURCE<hw>] :BB:EUTRa:DL:DRS:CELL<ch0>:PATtern on page 640

CSI-RS

During a discovery signal occasion, the eNB can configure up to 5 zero-power CSI reference signals (CSI-RS) and up to 96 non-zero-power CSI reference signals within the DRS period.

To configure the CSI-RS:

- Set "CSI-RS Part of DRS = On"

- Set "ZeroTxPower/NonZeroTxPower > Number of CSI-RS Configurations ≥ 1 "
- Configure the CSI-RS structures as required.
- In the "Signals > CSI-RS" dialog, define the parameter [Number of AP per CSI-RS Configuration](#) for the LAA "Cell".

CSI-RS that is part of the DRS uses the same antenna ports (APs) as the CSI-RS, see ["Mapping table"](#) on page 215.

Provided are the following ZeroTxPower and NonZeroTxPower parameters:

CSI-RS Part of DRS ← **CSI-RS**

Enables defining the CSI-RS part of the DRS.

Remote command:

[\[:SOURCE<hw>\]:BB:EUTRa:DL:DRS:CELL<ch0>:CDState](#) on page 640

ZeroTxPower/NonZeroTxPower CSI-RS Structure>Number of CSI-RS Configurations ← **CSI-RS**

Enables up to 5 ZeroTxPower CSI-RS and up to 96 NonZeroTxPower CSI-RS within the DRS period.

Remote command:

[\[:SOURCE<hw>\]:BB:EUTRa:DL:DRS:CELL<ch0>:ZPNum](#) on page 640

[\[:SOURCE<hw>\]:BB:EUTRa:DL:DRS:CELL<ch0>:NZPNum](#) on page 641

ZeroPower CSI-RS ← **CSI-RS**

Sets the used CSI-RS configurations in the zero transmission power subframes.

Required is a 16-bit-long hexadecimal value (bitmap). The UE assumes a zero transmission power for each bit set to one.

Remote command:

[\[:SOURCE<hw>\]:BB:EUTRa:DL:DRS:CELL<ch0>:CSIRs<st>:ZP](#) on page 641

Subframe Config (I_CSI-RS) ← **CSI-RS**

Sets the parameter $I_{\text{CSI-RS}}$ for CSI-RS with zero transmission power.

Remote command:

[\[:SOURCE<hw>\]:BB:EUTRa:DL:DRS:CELL<ch0>:CSIRs<st>:ZPI](#) on page 641

Periodicity (T_CSI-RS) ← **CSI-RS**

Indicates the parameter subframe configuration period $T_{\text{CSI-RS}}$ for CSI-RS with zero transmission power.

Remote command:

[\[:SOURCE<hw>\]:BB:EUTRa:DL:DRS:CELL<ch0>:CSIRs<st>:ZPT?](#) on page 642

Subframe Offset (Delta_CSI-RS) ← **CSI-RS**

Indicates the parameter subframe offset $\Delta_{\text{CSI-RS}}$ for CSI-RS with zero transmission power.

Remote command:

[\[:SOURCE<hw>\]:BB:EUTRa:DL:DRS:CELL<ch0>:CSIRs<st>:ZPDelta?](#)
on page 642

Number of AP per CSI-RS Configuration ← CSI-RS

Defines (or indicates) the number of antenna ports (one, two, four or eight) the CSI-RS are transmitted on.

Option: R&S SMM-K119

- This field is configured automatically, if **Number of CSI-RS Configurations** ≥ 2 is selected.
The value indicates the number of antenna ports per CSI-RS configuration $N_{\text{ports}}^{\text{CSI}}$ and is selected to comply with the aggregation rule, given in [Table 2-8](#).
- The value displayed in the "DRS" > "CSI-RS" on page 118 dialog resembles the value set in the "CSI-RS" dialog.

Use the [Cell-Specific Antenna Port Mapping](#) and configure the cell-specific antenna port mapping.

Remote command:

`[:SOURCE<hw>] :BB:EUTRa:DL:CSIS [:CELL<ch0>] :NAP` on page 631

Scrambling Identity (n_ID) ← CSI-RS

From LTE Rel. 12 on, eNBs can generate the individual NonZeroTxPower CSI-RS with separate scrambling identity n_{ID} (`scramblingIdentity`) [[TS 36.331](#)].

Remote command:

`[:SOURCE<hw>] :BB:EUTRa:DL:DRS:CELL<ch0>:CSIRs<st>:NZSCid`
on page 642

CSI-RS Configuration ← CSI-RS

Defines the CSI-RS configuration used for the current cell and for which the UE assumes non-zero transmission power.

Remote command:

`[:SOURCE<hw>] :BB:EUTRa:DL:DRS:CELL<ch0>:CSIRs<st>:NZConfig`
on page 643

Subframe Offset with SSS ← CSI-RS

Indicates the parameter subframe offset (`subframeOffset`) between the secondary synchronization signal (SSS) and the CSI-RS resource in a discovery signal occasion [[TS 36.331](#)].

Remote command:

`[:SOURCE<hw>] :BB:EUTRa:DL:DRS:CELL<ch0>:CSIRs<st>:NZSFoffset`
on page 643

Q-Offset ← CSI-RS

Sets the parameter Q-offset for cell-specific CSI-RS [[TS 36.331](#)].

Remote command:

`[:SOURCE<hw>] :BB:EUTRa:DL:DRS:CELL<ch0>:CSIRs<st>:NZQoffset`
on page 644

4.2.7.6 Narrowband positioning reference signals (NPRS) settings

Option: R&S SMM-K143

Access:

1. Select "Mode > LTE/eMTC/NB-LoT"
2. Select "General > Link Direction > Downlink (OFDMA)".
3. Select "General DL Settings > Physical > Channel Bandwidth ≥ 3 MHz"
4. Select "General DL Settings > Signals > NPRS".

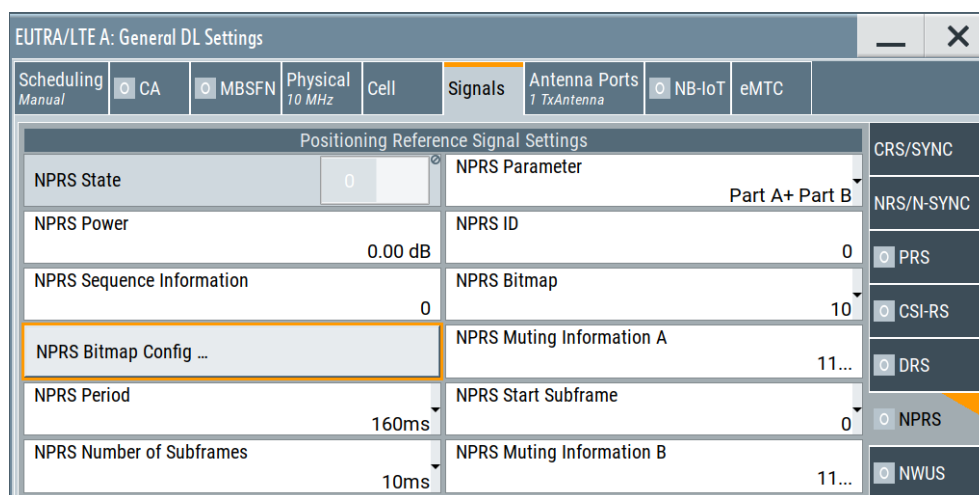

Comprises the settings for configuring the content of the PRS-Info-NB message, as defined in TS 36.355. This message contains information related to the configuration of the NB-LoT narrowband positioning reference signals (NPRS) in a cell.

NPRS State..... 121

NPRS Parameter..... 121

NPRS Power..... 122

NPRS ID..... 122

NPRS Sequence Information..... 122

NPRS Bitmap..... 122

NPRS Bitmap Config..... 122

NPRS Muting Information A/B..... 123

NPRS Period..... 123

NPRS Start Subframe..... 123

NPRS Number of Subframes..... 123

NPRS State

Enables using the narrowband positioning reference signals (NPRS).

Remote command:

[:SOURce<hw>] :BB:EUTRa:DL:NIOT:NPRS:STATe on page 825

NPRS Parameter

Defines which type of NPRS is used.

"Part A" Indicates a NPRS that is configured based on a bitmap of subframes, which are not NB-LoT downlink subframes.

"Part B" Enabled if "General DL Settings > NB-IoT > Carrier Type = Anchor" and "Carrier Mode = Standalone/Guard Band".
Indicates that a NPRS is configured based on a [NPRS Period](#), subframe offset ([NPRS Start Subframe](#)) and a number of consecutive NPRS DL subframes per position occasion ([NPRS Number of Subframes](#)).

"Part A+B" A subframe contains NPRS if both conditions for part A and Part B are fulfilled.

Remote command:

[:SOURce<hw>] :BB:EUTRa:DL:NIOT:NPRS:CONF on page 826

NPRS Power

Sets the power of the narrowband positioning reference signal (NPRS).

Remote command:

[:SOURce<hw>] :BB:EUTRa:DL:NIOT:NPRS:POW on page 826

NPRS ID

Sets the NPRS-ID used for the generation of the NPRS instead of using the physical cell ID (PCI).

Remote command:

[:SOURce<hw>] :BB:EUTRa:DL:NIOT:NPRS:ID on page 826

NPRS Sequence Information

Sets the parameter `nprsSequenceInfo` that specifies the index of the physical resource block (PRB) containing the NPRS.

Remote command:

[:SOURce<hw>] :BB:EUTRa:DL:NIOT:NPRS:SEIN on page 826

NPRS Bitmap

Sets if the NPRS subframe Part A configuration lasts 10 ms or 40 ms (`subframePattern10`, `subframePattern40`).

Remote command:

[:SOURce<hw>] :BB:EUTRa:DL:NIOT:NPRS:BMP:CONF on page 827

NPRS Bitmap Config

Opens a configuration dialog and sets the NPRS bitmap.

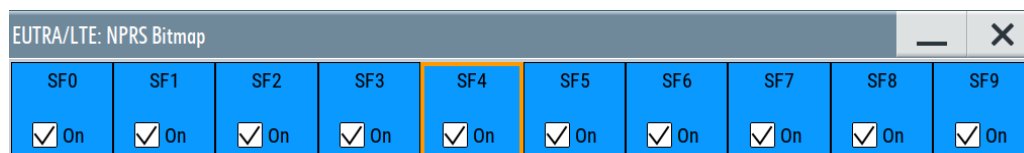

The dialog indicates whether a subframe (SF) is used for NPRS transmission. If an SF is disabled, it does not contain NPRS; such subframes are indicated with value '0' in the bitmap.

The selected subframes influence the scheduling of the NPRS transmissions.

Remote command:

[:SOURCE<hw>] :BB:EUTRa:DL:NIOT:NPRS:BMP:VALSubframes<ch>
on page 827

NPRS Muting Information A/B

Sets the `nprs-MutingInfoA/nprs-MutingInfoB` parameter, required if muting is used for the NPRS part A (and Part B) configurations.

"NPRS MutingInfo B" is displayed if **NPRS Parameter** = "Part B" or "Part A+B".

The `nprs-MutingInfo` field is a periodically repeating bit sequence with a length of 2, 4, 8 or 16 NPRS position occurrences, where:

"1" indicates that the NPRS is transmitted in the corresponding occasion; a "0" indicates a muted NPRS.

For Type A configuration, a NPRS position occasion comprises one radio frame (10 subframes). The muting sequence is applied to all subframes that follow the `nprs-MutingInfoA` message.

Remote command:

[:SOURCE<hw>] :BB:EUTRa:DL:NIOT:NPRS:MTIA on page 827
[:SOURCE<hw>] :BB:EUTRa:DL:NIOT:NPRS:MTIB on page 827

NPRS Period

For NPRS Part B configuration, sets the parameter `nprs-Period`, that defines the NPRS occasion period T_{NPRS} .

Remote command:

[:SOURCE<hw>] :BB:EUTRa:DL:NIOT:NPRS:PERiod on page 828

NPRS Start Subframe

For NPRS Part B configuration, sets the parameter `nprs-startSF`, that defines the subframe offset a_{NPRS} .

Remote command:

[:SOURCE<hw>] :BB:EUTRa:DL:NIOT:NPRS:STSFrame on page 828

NPRS Number of Subframes

For NPRS Part B configuration, sets the parameter `nprs-NumSF`, that defines the number of consecutive DL subframes N_{NPRS} within one NPRS positioning occasion.

If $N_{NPRS} > T_{NPRS}$, the UE should that NPRS is not transmitted in the cell.

Remote command:

[:SOURCE<hw>] :BB:EUTRa:DL:NIOT:NPRS:SFNM on page 828

4.2.7.7 NB-IoT wake-up signal (NWUS) settings

Access:

1. Select "General > Link Direction > Downlink".

2. Select "General DL Settings > Signals > NWUS".

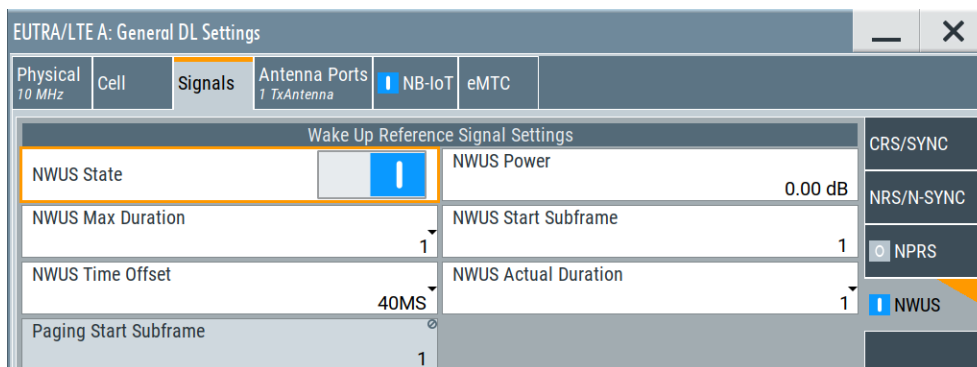

Option: R&S SMM-K146

Settings:

NWUS State..... 124
 NWUS Max Duration..... 124
 NWUS Power..... 124
 NWUS Start Subframe..... 124
 NWUS Time Offset..... 125
 NWUS Actual Duration..... 125
 Paging Start Subframe..... 125

NWUS State

Enables the NB-IoT wake up signal. If enabled, the wake-up signal (WUS) configuration is provided in system information.

WUS events are displayed in logging data.

Remote command:

[:SOURce<hw>] :BB:EUTRa:DL:NIOT:WUS:STATe on page 830

NWUS Max Duration

Sets the maximum WUS duration, expressed as a ratio of R_{max} .

Remote command:

[:SOURce<hw>] :BB:EUTRa:DL:NIOT:WUS:MAXDuration on page 829

NWUS Power

Sets the transmit power of NB-IoT wake up signal

Remote command:

[:SOURce<hw>] :BB:EUTRa:DL:NIOT:WUS:POW on page 829

NWUS Start Subframe

Specifies the first subframe for paging associated with a WUS transmission.

Remote command:

[:SOURce<hw>] :BB:EUTRa:DL:NIOT:WUS:SF on page 830

NWUS Time Offset

Sets the offset from the end of the configured maximum WUS duration to the associated paging occasion.

Remote command:

[:SOURce<hw>] :BB:EUTRa:DL:NIOT:WUS:TO on page 831

NWUS Actual Duration

Sets the duration of WUS in subframes.

Remote command:

[:SOURce<hw>] :BB:EUTRa:DL:NIOT:WUS:ACD on page 829

Paging Start Subframe

Queries the first paging occasion in subframes associated with WUS.

Remote command:

[:SOURce<hw>] :BB:EUTRa:DL:NIOT:WUS:PSF? on page 830

4.2.8 Antenna ports settings

Access:

1. Select "General > Link Direction > Downlink (OFDMA)".
2. Select "General DL Settings > Antenna Ports".

In the "Antenna Ports" section, the MIMO configuration and the simulated antennas are defined.

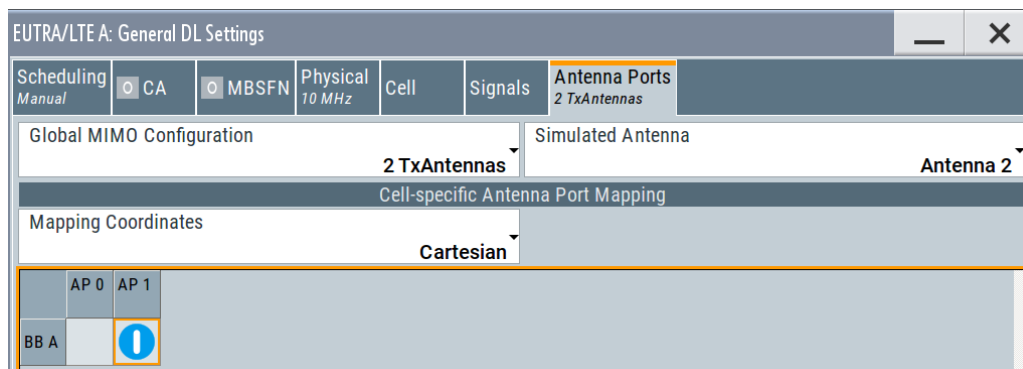

Global MIMO Configuration..... 125
 Simulated Antenna..... 126
 NB-IoT MIMO Configuration..... 126
 Cell-Specific Antenna Port Mapping..... 126

Global MIMO Configuration

Determines the number of transmit antennas of the simulated EUTRA/LTE system. The [Downlink Reference Signal Structure](#) is set accordingly (see also [Figure 2-9](#)).

Note: One baseband simulates one antenna.

- "1 TxAntenna" Enables single antenna port transmission.
- "2 TxAntennas/4 TxAntennas" Enables a multiple antenna transmission. The transmission mode, transmit diversity or spatial multiplexing, is determined per allocation with the parameter [Precoding Scheme](#).
- "SISO + BF" This mode combines the 1 transmit antenna Single Input Single Output (SISO) transmission with beamforming (BF). Beamforming is a method to increase the SNR of the signal received by the UE. In this mode, beamforming is implemented as a single layer PDSCH which is mapped to the different antennas with individual phase offsets. To simplify the configuration and to fulfill the requirements as specified in [TS 36.101](#), Annex A, the same precoding vector as in a MIMO case can be used.
- Note:** To enable the instrument to generate a **transmission using antenna port 5** signal (transmission corresponding to the UE-specific reference signal) as defined in the 3GPP specification, set the parameter [Precoding Scheme](#) to "Beamforming (UE-spec.RS)". In this case, the generated signal carries a combination of common signal part (PBCH, PDCCH, cell-specific RS,...), which is identical on all antennas, and UE-specific PDSCH, which is different on the antennas due to the applied precoding.
- Note that, although the generation of a beamformed signal requires more than one antenna, for the UE it appears as a SISO signal.

Remote command:

[\[:SOURCE<hw>\]:BB:EUTRa:DL:MIMO:CONFiguration](#) on page 581

Simulated Antenna

Defines the antenna to be simulated.

The configuration of the Downlink Reference Signal structure is set accordingly (see [Figure 2-9](#)).

Remote command:

[\[:SOURCE<hw>\]:BB:EUTRa:DL:MIMO:ANTenna](#) on page 581

NB-IoT MIMO Configuration

Option: R&S SMM-K115

For "Channel Bandwidth = 200 kHz or \geq 3 MHz", sets the number of transmit antennas used for the simulated NB-IoT system.

The NRS structure is set automatically.

To use Tx diversity:

- Select "NB-IoT MIMO Configuration = 2 Tx Antennas"
- In the mapping table, define the antenna port: select AP2000 or AP20001

Remote command:

[\[:SOURCE<hw>\]:BB:EUTRa:DL:MIMO:NIOT:CONFig](#) on page 831

Cell-Specific Antenna Port Mapping

Option: R&S SMM-K84/K85

Comprises the settings for defining the mapping of the logical antenna ports to the available physical Tx antennas (Basebands).

Refer to [Chapter 4.5, "DL antenna port mapping settings"](#), on page 213 for description of the provided settings.

4.3 DL frame configuration settings

Access:

1. Select "General > Link Direction > Downlink (OFDMA)".
2. Select "General DL Settings > Scheduling > Manual".
3. Select "General > Frame Configuration".

The "DL Frame Configuration" dialog allows you to configure the subframes and the OFDMA resource allocations. The dialog consists of several tabs.

• General frame configuration settings	127
• Dummy data configuration settings	129
• User configuration settings	130
• Auto sequence configuration	138
• EPDCCH configuration settings	147
• Scrambling configuration settings	152
• SPS configuration settings	153
• LAA settings	158
• Subframe configuration settings	163
• DL resource allocation table	164
• PCFICH settings	171
• PHICH settings	173
• (E)PDCCH settings	176
• (E)PDCCH format variable	180
• DCI format configuration	189

4.3.1 General frame configuration settings

Access:

1. Select "General > Link Direction > Downlink (OFDMA)".
2. Select "Frame Configuration > General".

3. Select "General DL Settings > Scheduling > Manual".

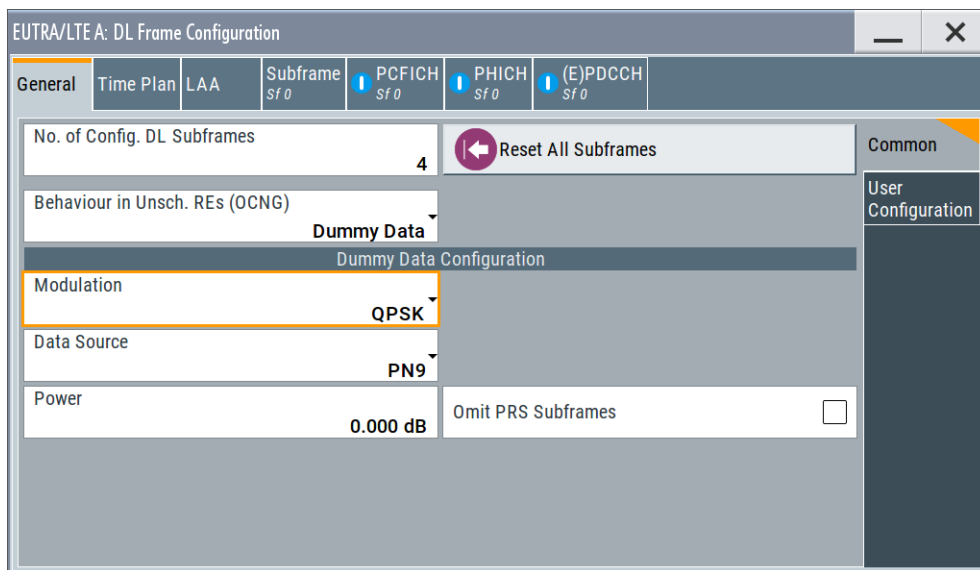

This dialog comprises the general settings that can be configured in the OFDMA mode.

Provided are the following settings:

No Of Configurable (DL) Subframes.....	128
Reset All Subframes.....	128
Behavior In Unscheduled REs (OCNG).....	128

No Of Configurable (DL) Subframes

Sets the number of configurable subframes. Only the downlink and the special subframes are enabled for configuration if TDD mode is selected.

All downlink/special subframes are filled periodically with the configured subframes except for the P-SYNC/S-SYNC. The last are set globally in the "General DL Settings" dialog. The PBCH can only be configured in subframe 0.

For more detailed information about the maximum number of configurable subframes and for description of the dependencies between the parameters, see [Chapter B.3, "Four configurable frames in uplink and downlink direction"](#), on page 949.

Remote command:

```
[ :SOURce<hw> ] :BB:EUTRa:DL:CONSubframes on page 605
```

Reset All Subframes

Resets settings of all subframes including cyclic prefix and number of used allocations to the default values.

Remote command:

```
[ :SOURce<hw> ] :BB:EUTRa:DL:RSTFrame on page 605
```

Behavior In Unscheduled REs (OCNG)

Selects either to fill unscheduled resource elements and subframes with dummy data or DTX.

This function can be used as an OFDMA Channel Noise Generator (OCNG) according to TS 36.101.

Remote command:

[:SOURce<hw>] :BB:EUTRa:DL:BUR on page 604

4.3.2 Dummy data configuration settings

Access:

- ▶ Select "Frame Configuration > Behavior in Unsch. REs (OCNG) > Dummy Data".

Behaviour in Unsch. REs (OCNG)	
Dummy Data	
Dummy Data Configuration	
Modulation	QPSK
Data Source	PN9
Power	0.000 dB
	Omit PRS Subframes <input type="checkbox"/>

In this section, the dummy data for filling the unscheduled resource blocks and subframes are configured.

Modulation.....	129
Data Source.....	129
Power (Dummy Data).....	130
Omit PRS Subframes.....	130

Modulation

Selects the modulation of the dummy data.

Remote command:

[:SOURce<hw>] :BB:EUTRa:DL:DUMD:MODulation on page 742

Data Source

Selects the data source for the dummy data configuration.

The following standard data sources are available:

- "All 0, All 1"
An internally generated sequence containing 0 data or 1 data.
- "PNxx"
An internally generated pseudo-random noise sequence.
- "Pattern"
An internally generated sequence according to a bit pattern.
Use the "Pattern" box to define the bit pattern.
- "Data List/Select DList"
A binary data from a data list, internally or externally generated.
Select "Select DList" to access the standard "Select List" dialog.

- Select the "Select Data List > navigate to the list file *.dm_iqd > Select" to select an existing data list.
- Use the "New" and "Edit" functions to create internally new data list or to edit an existing one.
- Use the standard "File Manager" function to transfer external data lists to the instrument.

See also:

- Section "Modulation Data" in the R&S SMM100A user manual.
- Section "File and Data Management" in the R&S SMM100A user manual.
- Section "Data List Editor" in the R&S SMM100A user manual

Remote command:

[\[:SOURce<hw>\]:BB:EUTRa:DL:DUMD:DATA](#) on page 743

[\[:SOURce<hw>\]:BB:EUTRa:DL:DUMD:PATtern](#) on page 744

[\[:SOURce<hw>\]:BB:EUTRa:DL:DUMD:DSElect](#) on page 743

Power (Dummy Data)

Sets the power of the subcarriers allocated with dummy data.

Remote command:

[\[:SOURce<hw>\]:BB:EUTRa:DL:DUMD:POWer](#) on page 743

Omit PRS Subframes

(requires R&S SMM-K84)

If the OCNB (OFDM Channel Noise Generator) is used, you can disable (omit) the OCNB transmission in the non-muted PRS subframes, as required for RSTD Performance Tests (TS 36.133, section A.9.8.1).

Tip: Use the [OFDMA time plan](#) to visualize the allocated resources.

See also [Example "How to visualize the effect of muting and omitting PRS transmission"](#) on page 105.

Remote command:

[\[:SOURce<hw>\]:BB:EUTRa:DL:DUMD:OPSubframes](#) on page 744

4.3.3 User configuration settings

Access:

1. Select "General > Link Direction > Downlink (OFDMA)"
2. Select "General DL Settings > Scheduling > Manual".

3. Select "Frame Configuration > General > User"

General	User	Time Plan	LAA	Subframe Sf 0	PCFICH Sf 0	PHICH Sf 0	(E)PDCCH Sf 0
	User 1	User 2	User 3	User 4			
State	On	On	On	On			
Activate CA	<input type="checkbox"/>	<input type="checkbox"/>	<input type="checkbox"/>	<input type="checkbox"/>			
Tx Modes	User	User	User	User			
UL Carriers	Config...	Config...	Config...	Config...			
UE Category	1	1	1	1			
EPDCCH / MPDCCH	Config...	Config...	Config...	Config...			
Antenna Mapping	Config...	Config...	Config...	Config...			
Scrambling	Config...	Config...	Config...	Config...			
Channel Coding	<input checked="" type="checkbox"/>	<input checked="" type="checkbox"/>	<input checked="" type="checkbox"/>	<input checked="" type="checkbox"/>			

Use the provided settings to configure up to four scheduled UEs. To distribute them over the whole frame, set the data source of a certain allocation to "User x". This approach ensures that a common data source is used for allocations of one user equipment also in case that these allocations are non-adjacent.

In one subframe, all allocations belonging to the same "User" use identical settings. Changing, for example, the modulation of one of the allocations of "User 1", changes the modulation in all other allocations of this user in the current subframe.

The aforementioned applies for the following settings:

- **Modulation**

Different modulations can be selected for the two codewords of an allocation.

	CW	Mod.	Enh. Sett.	VRB Gap	No. RB	No. Sym.	Offs RB	Offs Sym.	Auto	Phys. Bits	Data Source	DList / Pattern	ρ A /dB	Content Type	State	Conf
0	1/1	QPSK	Config...	-	6	4	22	7(1/0)	<input type="checkbox"/>	480	MIB	-	0.000	PBCH	On	
1	1/1	QPSK		-	50	2	0	0(0/0)	<input type="checkbox"/>	-	PDCCH	-	0.000	PDCCH	Off	
2	1/1	QPSK	Config...	-	1	14	0	0(0/0)	<input checked="" type="checkbox"/>	316	PN9	-	0.000	PDSCH	On	
3	1/1	QPSK	Config...	-	1	14	1	0(0/0)	<input checked="" type="checkbox"/>	316	PN9	-	0.000	PDSCH	On	
4	1/1	16QAM	Config...	-	1	14	2	0(0/0)	<input checked="" type="checkbox"/>	632	User3	-	0.000	PDSCH	On	
5	1/1	QPSK	Config...	-	1	14	3	0(0/0)	<input checked="" type="checkbox"/>	-	PN9	-	0.000	PDSCH	Off	
6	1/1	16QAM	Config...	-	1	14	3	0(0/0)	<input checked="" type="checkbox"/>	632	User3	-	0.000	PDSCH	On	
7	1/1	QPSK	Config...	-	1	14	4	0(0/0)	<input checked="" type="checkbox"/>	-	PN9	-	0.000	PDSCH	Off	

- Complete **Precoding settings**
- Scrambling settings (**Scrambling State, UE ID/n_RNTI**) and **Channel Coding State** temporarily.

See also the "Enhanced Settings" dialog of each allocation ([Chapter 4.4, "Enhanced PBCH, PDSCH and PMCH settings"](#), on page 202).

Settings:

User.....	132
State.....	132
3GPP Release.....	132
Activate CA.....	132
Tx Modes.....	133
UL Carriers Configuration.....	134
Configure Auto Sequence.....	134
UE Category.....	134
EPDCCH Config.....	134
Antenna Mapping Configuration.....	134
Scrambling Configuration.....	135
Channel Coding State.....	135
UE ID.....	135
Data Source, DList/Pattern.....	135
Data Source Init.....	136
eIMTA-RNTI.....	136
P_A.....	136
SPS Configuration.....	136
Aperiodic SRS State.....	136
CSI Awareness State.....	136
MSC Table.....	137
TBS Alt. Index.....	137
DMRS Alt Table.....	137
Semi Open Loop.....	138
Support two HARQ Processes.....	138

User

Displays the consecutive number of the users.

Remote command:

n.a.

State

Enables/disables a user.

Remote command:

[:SOURce<hw>] :BB:EUTRa:DL:USER<ch>:STATe on page 727

3GPP Release

Option: R&S SMM-K115

Sets the 3GPP release version the UE supports.

Remote command:

[:SOURce<hw>] :BB:EUTRa:DL:USER<ch>:RELease on page 863

Activate CA

Option: R&S SMM-K85

Enables/disables carrier aggregation for the selected user.

If [Activate Carrier Aggregation](#) is enabled, carrier aggregation is activated automatically for all users, but can be deactivated afterwards.

Remote command:

[:SOURce<hw>] :BB:EUTRa:DL:USER<ch>:CA:STATe on page 728

Tx Modes

Sets the transmission mode of the user as defined in [TS 36.213](#).

Consider the following prerequisites and interdependencies:

- "Tx Mode 8" and "Tx Mode 9" require R&S SMM-K84/K85.
- "Tx Mode 10" requires option R&S SMM-K112.
- The selected "Tx Mode" determines the range of allowed DCI formats, that is you can only assign valid DCI formats to this user.

For any PDSCH allocation, the software configures its "Precoding" as a function of the selected "Tx Mode" and the selected "DCI Format".

- In "Tx Mode > User", the range for valid DCI formats is not affected.
- If a carrier aggregation is enabled ([Activate Carrier Aggregation](#) = On and [Activate CA](#) = On), you access the "TxModes Configuration" dialog.

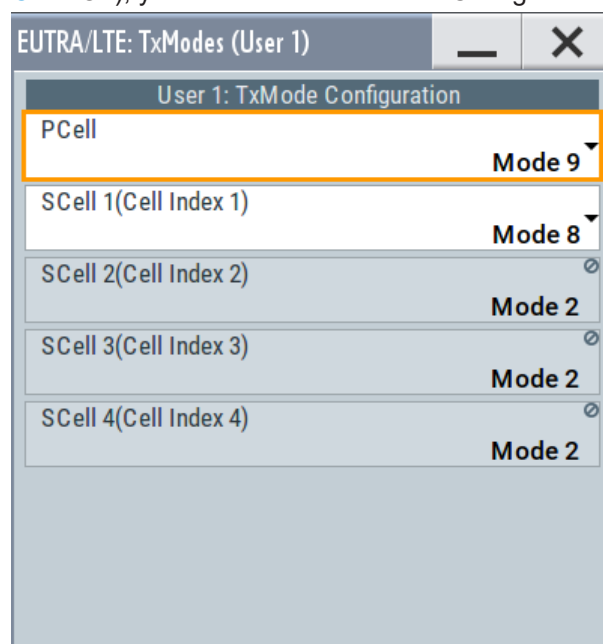

You can define the transmission mode a UE uses in the primary and the secondary cells.

- Option: R&S SMM-K119
SCells configured as LAA cells cannot use transmission modes "Tx Mode 5/6/7"
- Option: R&S SMM-K115
Available are "Tx Mode = User" and "Tx Mode = Mode 1, 2, 6 and 9".

Remote command:

[:SOURce<hw>] :BB:EUTRa:DL:USER<ch>:TXM on page 728

[:SOURce<hw>] :BB:EUTRa:DL:USER<ch>:CELL<st0>:TXM on page 728

UL Carriers Configuration

Option: R&S SMM-K85

If a carrier aggregation is enabled ([Activate Carrier Aggregation](#) = On), you can set the state of the associated UL carriers.

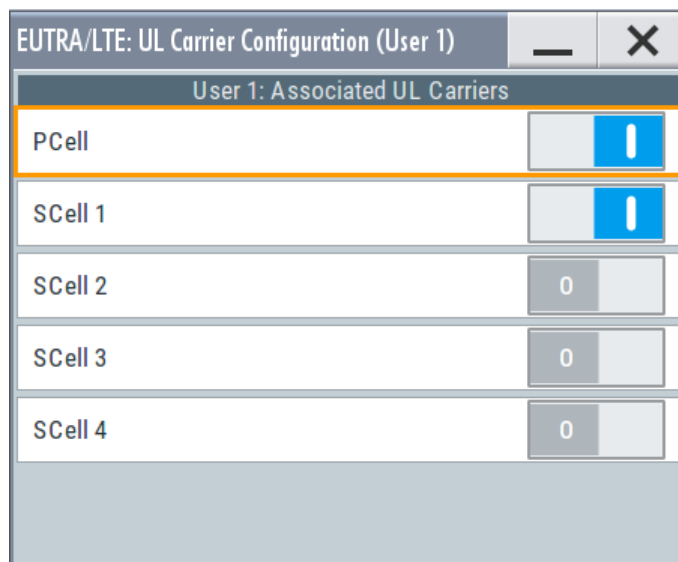

Option: R&S SMM-K119:

LAA SCells cannot be associated with UL carriers. For SCells using "CA > SCell x > Duplexing > LAA", the corresponding "SCell x > State = Off".

Remote command:

`[:SOURCE<hw>] :BB:EUTRa:DL:USER<ch>:ULCA<st0>:STATE` on page 729

Configure Auto Sequence

Option: R&S SMM-K112

If "General DL Settings > PDSCH Scheduling > Auto Sequence", access the "Auto Sequence" settings.

See [Chapter 4.3.4, "Auto sequence configuration"](#), on page 138.

UE Category

Sets the UE category.

Remote command:

`[:SOURCE<hw>] :BB:EUTRa:DL:USER<ch>:UEC` on page 728

EPDCCH Config

Option: R&S SMM-K112/K115

Opens the "EPDCCH Configuration" dialog, see [Chapter 4.3.5, "EPDCCH configuration settings"](#), on page 147.

Antenna Mapping Configuration

Use the [DL antenna port mapping settings](#) dialog to define the mapping of the logical antenna ports to the available physical Tx antennas, in one of the following cases:

- "Tx Mode = Tx Mode 7 to 10/User"

- "EPDCCH > Activate EPDCCH > On"

Scrambling Configuration

Opens the "Scrambling Configuration" dialog, see [Chapter 4.3.6, "Scrambling configuration settings"](#), on page 152.

Channel Coding State

Sets channel coding for all allocations belonging to the selected user.

That is, the parameter "Channel Coding State" determines the "Enhanced Settings > Channel Coding State" of all allocations for which you select the [Data Source](#) = "User x".

Remote command:

[\[:SOURCE<hw>\]:BB:EUTRa:DL:USER<ch>:CCODing:STATe](#) on page 732

UE ID

Sets the user equipment ID.

This UE ID is used for the generation of the scrambling sequence for the allocations, for which you select the [DL frame configuration settings](#) > "Allocation Table" > [Data Source](#) = "User x".

Remote command:

[\[:SOURCE<hw>\]:BB:EUTRa:DL:USER<ch>:UEID](#) on page 732

Data Source, DList/Pattern

Selects the data source for the selected user.

The following standard data sources are available:

- "All 0, All 1"
An internally generated sequence containing 0 data or 1 data.
- "PNxx"
An internally generated pseudo-random noise sequence.
- "Pattern"
An internally generated sequence according to a bit pattern.
Use the "Pattern" box to define the bit pattern.
- "Data List/Select DList"
A binary data from a data list, internally or externally generated.
Select "Select DList" to access the standard "Select List" dialog.
 - Select the "Select Data List > navigate to the list file *.dm_iqd > Select" to select an existing data list.
 - Use the "New" and "Edit" functions to create internally new data list or to edit an existing one.
 - Use the standard "File Manager" function to transfer external data lists to the instrument.

See also:

- Section "Modulation Data" in the R&S SMM100A user manual.
- Section "File and Data Management" in the R&S SMM100A user manual.
- Section "Data List Editor" in the R&S SMM100A user manual

Remote command:

[:SOURCE<hw>] :BB:EUTRa:DL:USER<ch>:DATA on page 732

[:SOURCE<hw>] :BB:EUTRa:DL:USER<ch>:DSElect on page 733

[:SOURCE<hw>] :BB:EUTRa:DL:USER<ch>:PATTern on page 733

Data Source Init

Selects the starting seed for data sources for the PDSCH allocation.

Remote command:

[:SOURCE<hw>] :BB:EUTRa:DL:USER<ch>:INITpattern on page 733

eIMTA-RNTI

Option: R&S SMM-K113

Sets the dedicated eIMTA-RNTI used for CRC scrambling of the PDCCH.

See also "[Enhanced interference mitigation & traffic adaption \(eIMTA\)](#)" on page 52.

Remote command:

[:SOURCE<hw>] :BB:EUTRa:DL:USER<ch>:EIMTarnti on page 734

P_A

Sets PDSCH power factor according to [TS 36.213](#), chapter 5.2.

This power value is applied to all allocations that belong to the corresponding user. The power of an allocation is also determined by the parameter "PDSCH Scheduling Mode". In a normal operation, the power values in the allocation table are configurable parameters. In the "Auto/DCI" mode however, the power value is fixed and cannot be adjusted.

For the DCI format 1D, an additional level offset has to be considered.

Remote command:

[:SOURCE<hw>] :BB:EUTRa:DL:USER<ch>:PA on page 734

SPS Configuration

Accesses the [SPS configuration settings](#) dialog to configure a semi-persistence scheduling for the selected user.

Aperiodic SRS State

Configures if the UE supports aperiodic transmission of SRS.

The aperiodic SRS transmission is a single (one-shot) transmission. Activate this parameter to be able to trigger SRS transmissions of the user by the DCIs.

Use the parameter [DCI Format 1A](#) > "SRS Request" to select one of the three SRS parameter sets.

Remote command:

[:SOURCE<hw>] :BB:EUTRa:DL:USER<ch>:ASRS:STATE on page 734

CSI Awareness State

Enables/disables the CSI awareness for the selected user, i.e. informs the UE that a CSI-RS are transmitted. See also "[CSI reference signals](#)" on page 31.

Remote command:

[:SOURCE<hw>] :BB:EUTRa:DL:USER<ch>:CAW:STATE on page 734

MSC Table

Option: R&S SMM-K113/-K119

Defines which of the MSC tables defined in [TS 36.213](#) is used to specify the used modulation and coding scheme:

"1"	Option: R&S SMM-K113 Table 7.1.7.1-1
"2"	Option: R&S SMM-K113 Table 7.1.7.1-1A
"3"	Option: R&S SMM-K119 Table 7.1.7.1-1B
"4"	Option: R&S SMM-K119 Table 7.1.7.1-1C

Remote command:

`[:SOURCE<hw>] :BB:EUTRa:DL:USER<ch>:CELL<st0>:MCS` on page 735

TBS Alt. Index

Option: R&S SMM-K113/-K119

If "General DL Settings > PDSCH Scheduling > Auto DCI", enables using the extended TBS range for the PDSCH allocations scheduled by DCI format 1/1B/1D/2/2A/2B/2C/2D.

Sets the which of the transport block size (TBS) tables defined in [TS 36.213](#) is used:

"0"	Option: R&S SMM-K113 Table 7.1.7.1-1, up to TBS Index $I_{TBS} = 26$
"1"	Option: R&S SMM-K113 Alternative TBS Index $I_{TBS} = 26A$ in table 7.1.7.1-1, TBS Index $I_{TBS} = 33A$ in tables 7.1.7.1-1A/B/C
"2"	Option: R&S SMM-K119 Alternative TBS Index $I_{TBS} = 33B$ in tables 7.1.7.1-1A/B/C
"3"	Option: R&S SMM-K119 Alternative TBS Index $I_{TBS} = 37A$ in tables 7.1.7.1-1B/C

Remote command:

`[:SOURCE<hw>] :BB:EUTRa:DL:USER<ch>:CELL<st0>:TBAL` on page 735

DMRS Alt Table

Option: R&S SMM-K119

For **Tx Modes** = "TM9/TM10", sets the value of the higher-layer parameter `dmrs-tableAlt`.

With "[Scheduling > Auto DCI/Auto Sequence](#)", it defines the antenna port mapping and the value range of the parameter [DCI Format 2/2A/2B/2C/2D](#) > "Ant. Port(s), Layers, SCID".

Remote command:

`[:SOURCE<hw>] :BB:EUTRa:DL:USER<ch>:CELL<st0>:DMRS:STATe`
on page 736

Semi Open Loop

Option: R&S SMM-K119

For **Tx Modes** = "TM9/TM10", sets the value of the higher-layer parameter `semiOpenLoop`.

With "**Scheduling > Auto DCI/Auto Sequence**", it defines the antenna port mapping and the value range of the parameter **DCI Format 2/2A/2B/2C/2D** > "Ant. Port(s), Layers, SCID".

Remote command:

[:SOURCE<hw>] :BB:EUTRa:DL:USER<ch>:CELL<st0>:SEOL:STATe
on page 736

Support two HARQ Processes

Indicates if a NB-IoT UE is capable of understanding the HARQ process bit.

- Option: R&S SMM-K115
The parameter is disabled and cannot be changed.
- Option: R&S SMM-K143
Enables the UE to support the HARQ process bit.
To set the HARQ process number bit (`twoHARQ-Processes`), use the DCI parameter "DL Frame Configuration > NB-IoT > DCI table > DCI Format = 0 > User = User x > Content > Config > HARQ Process Number", see "**DCI Format N0**" on page 383.

Remote command:

[:SOURCE<hw>] :BB:EUTRa:DL:USER<ch>:STHP:STATe on page 736

4.3.4 Auto sequence configuration

The "Auto Sequence" mode requires the additional software option R&S SMM-K112. This mode supports you to generate EUTRA/LTE signals from a sequence perspective.

In "Auto Sequence" mode, you configure the sequence-related settings once per active User; all related parameters are calculated automatically.

Impact of the "Auto Sequence" mode on the configuration of DCIs

The following applies for each active user (**State** > On) and for every active cell:

- There is one DL DCI and one UL DCI for the user and the cell in the PDCCH DCI table. Comprehend these DCIs as template DCIs. The DCIs which are used for the generated subframes are derived from them, with modifications according to the auto sequence DCI tables.
See [Figure 4-6](#)
- Suitable DCI formats are selected automatically, according to the [Tx Modes](#).
- If [Activate Carrier Aggregation](#) is enabled, the Cell Index for the DL-DCI and UL-DCI is set to the selected [sched. Cell Index](#)
- Several parameters of the DCI formats are automatically varied throughout the subframes (see [DCI format configuration](#)).

For example:

- The modulation and coding scheme (MCS) and HARQ-related parameters are indicated as "Auto"
- If **CIF Present** is enabled, the CIF parameter in the DL-DCI and UL-DCI is set to the selected **Cell Index**

4.3.4.1 How to enable and use the auto sequence mode

This example focuses on the "Auto Sequence" settings and their impact. For step-by-step instruction on how to enable the required configuration, see [Chapter 4.2.2.2, "How to enable carrier aggregation and cross-carrier scheduling"](#), on page 72.

1. Select "Baseband > EUTRA/LTE > General DL Setting > CA".

Enable for example the following settings:

Cell Index	Phys. Cell ID	Bandwidth	Δf /MHz	Duplexing	UL/DL Config	Sp. SF Config	sched. CellIndex	CIF Pres.	Enhanced Settings	Power /dB	Delay /ns	State
0	0	10	10 MHz	0.000 000	FDD	-	0	<input type="checkbox"/>	Config...	0.00	0	On
1	7	1	10 MHz	0.000 000	FDD	-	7	<input checked="" type="checkbox"/>	Config...	0.00	0	On
2	2	2	10 MHz	0.000 000	FDD	-	2	<input type="checkbox"/>	Config...	0.00	0	Off
3	3	3	10 MHz	0.000 000	FDD	-	3	<input type="checkbox"/>	Config...	0.00	0	Off
4	4	4	10 MHz	0.000 000	FDD	-	4	<input type="checkbox"/>	Config...	0.00	0	Off

1 = Cross-carrier scheduling is disabled (SCell#1 uses "schedCellIndex = 7")

2 = "CIF Preset > On"

2. Select "General DL Setting > Scheduling > PDSCH Scheduling > Auto Sequence".

3. Select "EUTRA/LTE > DL Frame Configuration > General".

Enable "User > User 1/User 2 > State > On".

The subframe-related settings are not displayed. Compare these settings to the settings described in [Chapter 4.3, "DL frame configuration settings"](#), on page 127.

EUTRA/LTE A: DL Frame Configuration									
General	User	Time Plan	LAA	Subframe	PCFICH	PHICH	(E)PDCCH		
	User 1	User 2	User 3	User 4					
State	On	On	Off	Off					
Activate CA	<input checked="" type="checkbox"/>	<input checked="" type="checkbox"/>	<input checked="" type="checkbox"/>	<input checked="" type="checkbox"/>					
Tx Modes	9/9/-/-/...	7/7/-/-/...	2/2/-/-/...	2/2/-/-/...					
UL Carriers	Config...	Config...	Config...	Config...					
Auto Sequence	Config...	Config...	Config...	Config...					
UE Category	User	User	User	User					
EPDCCH / MPDCCH	Config...	Config...	Config...	Config...					
Antenna Mapping	Config...	Config...	Config...	Config...					
Scrambling	Config...	Config...	Config...	Config...					
Channel Coding	<input checked="" type="checkbox"/>	<input checked="" type="checkbox"/>	<input checked="" type="checkbox"/>	<input checked="" type="checkbox"/>					
UE ID	0	0	0	0					
Data Source	PN9	PN9	PN9	PN9					
DList/Pattern	-	-	-	-					

- Select "DL Frame Configuration > PDCCH > DCI Table".
Observe the settings.

													Reset	Resolve Conflicts	General
	User	UE_ID n_RNTI	Cell Index	CIF	(E)PDCCH	DCI Format	Search Space	Content	(E)PDCCH Format	Number (E)CCes	(E)CCE Index	No.Dummy (E)CCes	C	DCI Table	
0	User1	0	0	0	PDCCH	0	0-Spec	Config...	0	1	4	0			
1	User1	0	0	0	PDCCH	1A	0-Spec	Config...	0	1	5	20			
2	User1	0	7	7	PDCCH	0	UE-Spec	Config...	0	1	20	0			
3	User1	0	7	7	PDCCH	1A	UE-Spec	Config...	0	1	21	4			
4	User2	0	0	0	PDCCH	0	UE-Spec	Config...	0	1	0	0			
5	User2	0	0	0	PDCCH	1A	UE-Spec	Config...	0	1	1	2			
6	User2	0	7	7	PDCCH	0	UE-Spec	Config...	0	1	16	0			
7	User2	0	7	7	PDCCH	1A	UE-Spec	Config...	0	1	17	2			

Figure 4-6: DCI table in PDSCH Scheduling > Auto Sequence mode

- 1a, 1b = Two active users, "User1" and "User2"
- 2a, 2b = Two active cells with "schedCell Index = 0 and 7"
- 3a, 3b = Automatically selected "DCI format = 0 and 1A" per cell, see "Impact of the "Auto Sequence" mode on the configuration of DCIs" on page 138

5. In "DCI Table", select "User1 > DCI Format 1A > Content > Config" for the DCI with "Cell Index = 7".

The "DCI Format Configuration" confirms the configuration: "CIF = 7", MCS and HARQ-related settings are set to "Auto".

6. To configure the HARQ transmission:
 - a) Open the "DL Frame Configuration > General > User Configuration > User1 > Auto Sequence > Config" dialog.

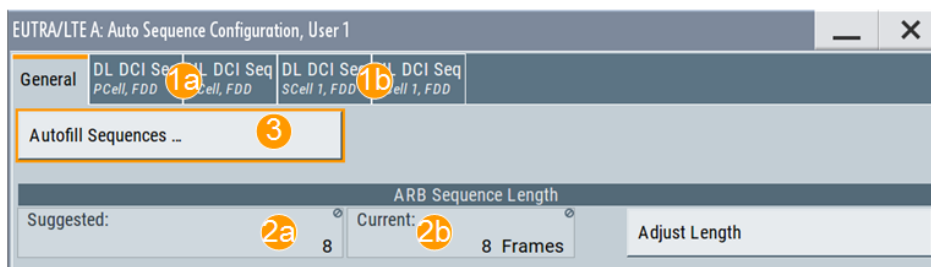

Figure 4-7: Auto Sequence settings: Understanding the displayed information

1a, 1b = Automatically selected DL DCI and UL DCI per cell, see "Impact of the "Auto Sequence" mode on the configuration of DCIs" on page 138

2a, 2b = Suggested and current ARB sequence length

- b) Select "Auto Sequence > Autofill Sequences". Configure the HARQ transmission. Select "Apply". See Figure 4-8.
- c) If the current ARB sequence length deviates from the suggested one, select "Adjust Sequence Length".

The "Auto Sequence > DL/UL DCI Seq" display the resulting sequences.

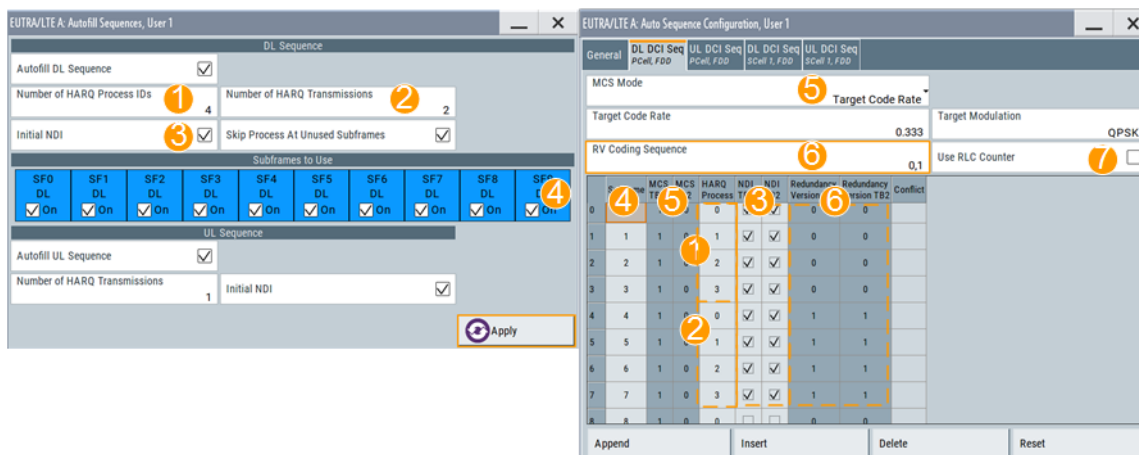

Figure 4-8: "Autofill Settings" and "Auto Sequence Configuration": Understanding the displayed information

- 1 = "Number of HARQ Processes = 4"; the HARQ Processes IDs change cyclically from 0 to 3
- 2 = "Number of HARQ Transmissions = 2"; the four HARQ Processes are transmitted 2 times
- 3 = "Initial NDI = On"; the New Data Indicator (NDI) is enabled for "Number of HARQ Transmissions = 2" times and starting with the first HARQ process

- 4 = "Subframes to use = all DL subframes"
- 5 = "MCS Mode = Target Code Rate"; the modulation and coding scheme values (MCS) are set automatically to fulfill the required "Target Code Rate" for the selected "Target Modulation"
- 6 = "RV Coding Sequence = 0,1", where each the redundancy version value is used for one HARQ transmission
- 7 = "Use RLC Counter = On"
- TB1, = NDI, RV and RLC values are provided per transport block (TB), where the number of TBs
- TB2 depends on the MIMO configuration

4.3.4.2 Auto sequence settings

To access this dialog:

1. Select "EUTRA/LTE > General DL Setting > Scheduling > PDSCH Scheduling > Auto Sequence".
2. Select "DL Frame Configuration > General > User Configuration > User1 > Auto Sequence > Config."

The "Auto Sequence" dialog opens.

See [Figure 4-7](#).

For instruction on how to use these settings, see [Chapter 4.3.4.1, "How to enable and use the auto sequence mode"](#), on page 139.

Autofill Sequences.....	142
L Autofill DL/UL Sequence.....	143
L Number of HARQ Process IDs.....	143
L Number of HARQ Transmissions.....	143
L Initial NDI.....	143
L Skip Process at Unused Subframes.....	144
L Subframes to Use:.....	144
L Apply.....	144
ARB Sequence Length > Suggested, Adjust Length.....	144
DL DCI Sequence.....	144
L MCS Mode.....	144
L MCS.....	145
L Target Code Rate, Target Modulation.....	145
L RV coding Sequence.....	145
L Use RLC Counter.....	145
L DL DCI Sequence Table.....	145
UL DCI Sequence.....	146
L Vary UL TX Power and RBA.....	146
L UL DCI Sequence Table.....	146
Append, Insert, Delete, Reset.....	147

Autofill Sequences...

Access a dialog with settings to configure the DL and UL DCIs.

EUTRA/LTE: Autofill Sequences, User 1

DL Sequence

Autofill DL Sequence

Number of HARQ Process IDs Number of HARQ Transmissions

Initial NDI Skip Process At Unused Subframes

Subframes to Use

SF0	SF1	SF2	SF3	SF4	SF5	SF6	SF7	SF8	SF9
DL	DL	DL	DL	DL	DL	DL	DL	DL	DL
<input checked="" type="checkbox"/> On	<input checked="" type="checkbox"/> On	<input checked="" type="checkbox"/> On	<input checked="" type="checkbox"/> On	<input checked="" type="checkbox"/> On	<input checked="" type="checkbox"/> On	<input checked="" type="checkbox"/> On	<input checked="" type="checkbox"/> On	<input checked="" type="checkbox"/> On	<input checked="" type="checkbox"/> On

UL Sequence

Autofill UL Sequence

Number of HARQ Transmissions Initial NDI

Apply

To configure the Auto Sequence DCI tables of the user automatically, enable the "Autofill DL/UL Sequence" parameters, adjust the settings, and confirm with "Apply".

See [Figure 4-8](#) for illustration on how these settings are processed.

Autofill DL/UL Sequence ← Autofill Sequences...

Automatically fill the auto sequence DCI tables of the user in a meaningful and standard-compliant way.

Remote command:

[\[:SOURCE<hw>\]:BB:EUTRa:DL:USER<ch>:AS:DL:AFSeq](#) on page 692

[\[:SOURCE<hw>\]:BB:EUTRa:DL:USER<ch>:AS:UL:AFSeq](#) on page 692

Number of HARQ Process IDs ← Autofill Sequences...

Sets the number of HARQ process IDs.

Remote command:

[\[:SOURCE<hw>\]:BB:EUTRa:DL:USER<ch>:AS:DL:NHIDs](#) on page 692

Number of HARQ Transmissions ← Autofill Sequences...

Sets the number of HARQ transmissions.

Remote command:

[\[:SOURCE<hw>\]:BB:EUTRa:DL:USER<ch>:AS:DL:NHTRans](#) on page 693

[\[:SOURCE<hw>\]:BB:EUTRa:DL:USER<ch>:AS:UL:NHTRans](#) on page 693

Initial NDI ← Autofill Sequences...

Defines whether the "New Data Indicator" flag is set at the beginning of the sequence or cleared.

Remote command:

[:SOURCE<hw>] :BB:EUTRa:DL:USER<ch>:AS:DL:INDI on page 693

[:SOURCE<hw>] :BB:EUTRa:DL:USER<ch>:AS:UL:INDI on page 693

Skip Process at Unused Subframes ← Autofill Sequences...

Defines how the HARQ processes are distributed throughout the used subframes.

Remote command:

[:SOURCE<hw>] :BB:EUTRa:DL:USER<ch>:AS:DL:SKPProcess on page 693

Subframes to Use: ← Autofill Sequences...

Sets the downlink subframes to be used for the HARQ transmission as a pattern of "0" and "1", where 1 enables a subframe.

Do not set the uplink subframes; in FDD duplexing mode, used are all subframes and in TDD mode, all downlink and special subframes that are allowed to schedule uplink transmissions.

Remote command:

[:SOURCE<hw>] :BB:EUTRa:DL:USER<ch>:AS:DL[:CELL<ccid>]:
USUBframe<dir0> on page 694

Apply ← Autofill Sequences...

Applies the settings

Remote command:

[:SOURCE<hw>] :BB:EUTRa:DL:USER<ch>:AS:APPLY on page 694

ARB Sequence Length > Suggested, Adjust Length

Displays the suggested and currently used ARB sequence length.

If the current ARB sequence length deviates from the suggested one, select "Adjust Sequence Length". The ARB sequence length is set automatically.

Remote command:

[:SOURCE<hw>] :BB:EUTRa:DL:USER<ch>:AS:ARBLen? on page 692

[:SOURCE<hw>] :BB:EUTRa:DL:USER<ch>:AS:ASLength on page 692

DL DCI Sequence

The DL DCIs are defined in table form that can be filled in manually, by adding rows and configuring them, or automatically, with the [Autofill Sequences...](#) settings.

See [Figure 4-8](#) for illustration on how these settings are processed.

MCS Mode ← DL DCI Sequence

Sets how the Modulation and Coding Scheme is configured.

"Manual" Enter the MCS value in the corresponding column

"Fixed" The MCS value is fixed and configured with the parameter [MCS](#)

"Target Code Rate"

The required MCS value is calculated based on the selected "Target Code Rate" and "Target Modulation".

Remote command:

[:SOURCE<hw>] :BB:EUTRa:DL:USER<ch>:AS:DL:CELL<st0>:MCSMode
on page 694

MCS ← DL DCI Sequence

In "MCS Mode > Fixed", sets the MCS value.

Remote command:

[:SOURCE<hw>] :BB:EUTRa:DL:USER<ch>:AS:DL:CELL<st0>:FMCS
on page 694

Target Code Rate, Target Modulation ← DL DCI Sequence

In "MCS Mode > Target Code Rate", sets the target code rate and modulation (QPSK, 16QAM, 64QAM).

Remote command:

[:SOURCE<hw>] :BB:EUTRa:DL:USER<ch>:AS:DL:CELL<st0>:TCR on page 695
[:SOURCE<hw>] :BB:EUTRa:DL:USER<ch>:AS:DL:CELL<st0>:TMOD
on page 695

RV coding Sequence ← DL DCI Sequence

Sets the redundancy version sequence to be used.

Remote command:

[:SOURCE<hw>] :BB:EUTRa:DL:USER<ch>:AS:DL:CELL<st0>:RVSequence
on page 695

Use RLC Counter ← DL DCI Sequence

Enables/disables the use of radio link control (RLC) counter.

Remote command:

[:SOURCE<hw>] :BB:EUTRa:DL:USER<ch>:AS:DL:CELL<st0>:URLCounter
on page 698

DL DCI Sequence Table ← DL DCI Sequence

The DCIs are configured in table form. If the [Autofill Sequences...](#) function is used, several parameters are preconfigured.

In TDD mode, the DCI table lists only the DL and special subframes.

A conflict indicates an erroneous situation, like for example if the selected "Target Code Rate" cannot be achieved.

Remote command:

[:SOURCE<hw>] :BB:EUTRa:DL:USER<ch>:AS:UL:CELL<st0>:SLENgth?
on page 696
[:SOURCE<hw>] :BB:EUTRa:DL:USER<ch>:AS:DL:CELL<st0>:
SEQelem<dir0>:SUBFrame on page 697
[:SOURCE<hw>] :BB:EUTRa:DL:USER<ch>:AS:DL:CELL<st0>:
SEQelem<dir0>:TB1:MCS on page 697
[:SOURCE<hw>] :BB:EUTRa:DL:USER<ch>:AS:DL:CELL<st0>:
SEQelem<dir0>:HARQ on page 695
[:SOURCE<hw>] :BB:EUTRa:DL:USER<ch>:AS:DL:CELL<st0>:
SEQelem<dir0>:TB1:NDI on page 697

[:SOURCE<hw>] :BB:EUTRa:DL:USER<ch>:AS:DL:CELL<st0>:
SEQelem<dir0>:TB1:RV on page 698

[:SOURCE<hw>] :BB:EUTRa:DL:USER<ch>:AS:DL:CELL<st0>:
SEQelem<dir0>:TB1:RLCCounter on page 698

[:SOURCE<hw>] :BB:EUTRa:DL:USER<ch>:AS:DL:CELL<st0>:
SEQelem<dir0>:PDRE on page 696

[:SOURCE<hw>] :BB:EUTRa:DL:USER<ch>:AS:DL:CELL<st0>:
SEQelem<dir0>:CONFLICT? on page 698

UL DCI Sequence

The UL DCIs are defined in table form, that can be filled in manually, by adding rows and configuring them, or automatically, with the [Autofill Sequences...](#) settings.

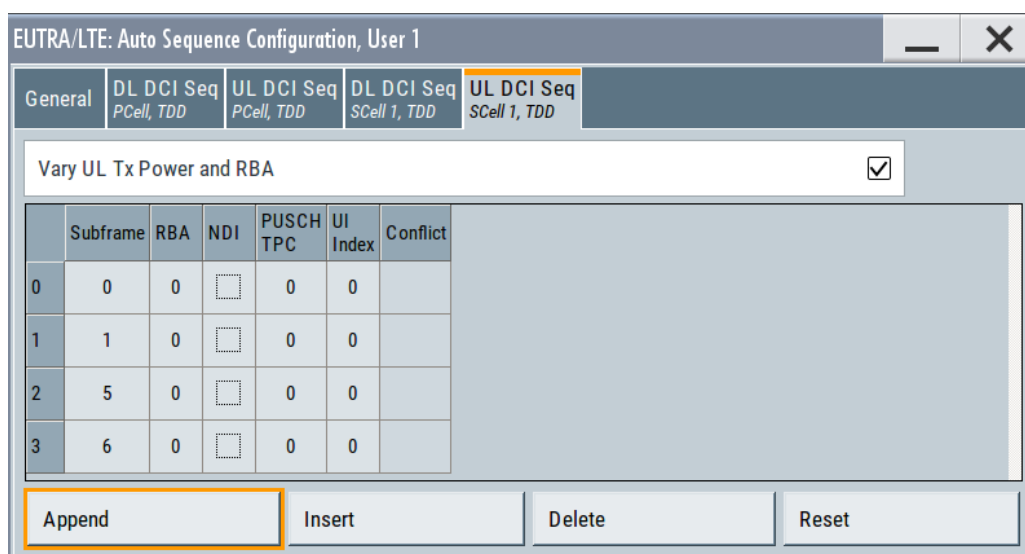

Figure 4-9: UL DCI Sequence settings in TDD mode ("UL/DL Configuration = 0")

Vary UL TX Power and RBA ← UL DCI Sequence

Enables the "PUSCH TPC" column in the table.

Remote command:

[:SOURCE<hw>] :BB:EUTRa:DL:USER<ch>:AS:UL:CELL<st0>:VULTxpow
on page 700

UL DCI Sequence Table ← UL DCI Sequence

The DCIs are configured in table form. If the [Autofill Sequences...](#) function is used, several parameters are preconfigured.

In TDD mode, the DCI table lists only the DL and special subframes. The "UL Index" parameter is displayed if a [TDD UL/DL Configuration = 0](#) is used.

Remote command:

[:SOURCE<hw>] :BB:EUTRa:DL:USER<ch>:AS:UL:CELL<st0>:SLENgth?
on page 696
[:SOURCE<hw>] :BB:EUTRa:DL:USER<ch>:AS:UL:CELL<st0>:
SEQelem<dir0>:SUBFrame on page 697

[:SOURce<hw>] :BB:EUTRa:DL:USER<ch>:AS:UL:CELL<st0>:
 SEQelem<dir0>:RBA on page 699

[:SOURce<hw>] :BB:EUTRa:DL:USER<ch>:AS:UL:CELL<st0>:
 SEQelem<dir0>:NDI on page 697

[:SOURce<hw>] :BB:EUTRa:DL:USER<ch>:AS:UL:CELL<st0>:
 SEQelem<dir0>:PTPC on page 699

[:SOURce<hw>] :BB:EUTRa:DL:USER<ch>:AS:UL:CELL<st0>:
 SEQelem<dir0>:ULINdex on page 699

[:SOURce<hw>] :BB:EUTRa:DL:USER<ch>:AS:UL:CELL<st0>:
 SEQelem<dir0>:CONFlict? on page 698

Append, Insert, Delete, Reset

Standard functions for handling of table elements.

Remote command:

[:SOURce<hw>] :BB:EUTRa:DL:USER<ch>:AS:DL:CELL<st0>:SELelement
 on page 700

[:SOURce<hw>] :BB:EUTRa:DL:USER<ch>:AS:DL:CELL<st0>:APPend
 on page 700

[:SOURce<hw>] :BB:EUTRa:DL:USER<ch>:AS:DL:CELL<st0>:INSert
 on page 700

[:SOURce<hw>] :BB:EUTRa:DL:USER<ch>:AS:DL:CELL<st0>:DELeTe
 on page 701

[:SOURce<hw>] :BB:EUTRa:DL:USER<ch>:AS:DL:CELL<st0>:RESet
 on page 701

[:SOURce<hw>] :BB:EUTRa:DL:USER<ch>:AS:UL:CELL<st0>:SELelement
 on page 700

[:SOURce<hw>] :BB:EUTRa:DL:USER<ch>:AS:UL:CELL<st0>:APPend
 on page 700

[:SOURce<hw>] :BB:EUTRa:DL:USER<ch>:AS:UL:CELL<st0>:INSert
 on page 700

[:SOURce<hw>] :BB:EUTRa:DL:USER<ch>:AS:UL:CELL<st0>:DELeTe
 on page 701

[:SOURce<hw>] :BB:EUTRa:DL:USER<ch>:AS:UL:CELL<st0>:RESet
 on page 701

4.3.5 EPDCCH configuration settings

Option: R&S SMM-K112/K115

Access:

1. Select "General > Link Direction > Downlink (OFDMA)"
2. Select "General DL Settings > Scheduling" > **"Auto/DCI"**
 EPDCCH cannot be activated in manual mode ("Scheduling > Manual")
3. Select "Frame Configuration > General > User"
4. Select "User# > EPDCCH > Config"

- Set "Activate EPDCCH > On".

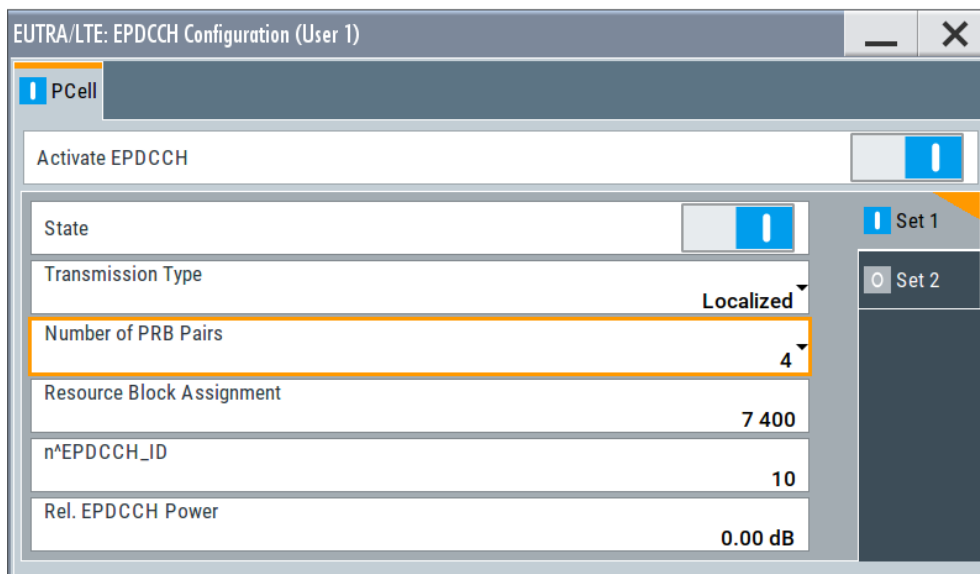

You can enable and configure the EPDCCH parameters for the selected user and, if DL carrier aggregation is used, also per component carrier.

- Select "Frame Configuration > E(DPCCH)".
- In the "DCI Table", select "User 1 > (E)EPDCCH > EPDCCH Set 1".
- Select "Frame Configuration > Subframe > Subframe#0 > Allocation Table" to observe the EPDCCH allocation.

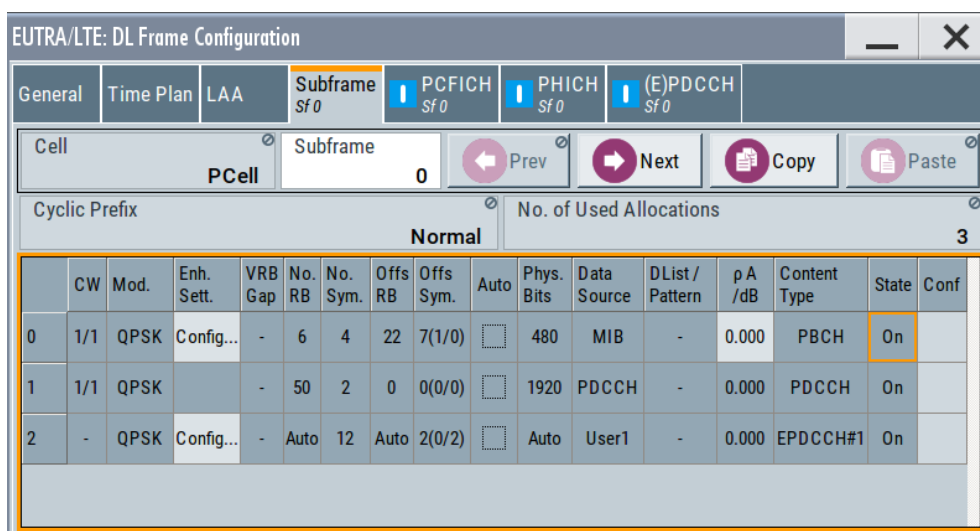

The parameters of the EPDCCH#1 allocation and the most of the available parameters are set automatically.

- Select "EPDCCH > Enhanced Settings > Config" to observe the percoding information, i.e. the used antenna ports.

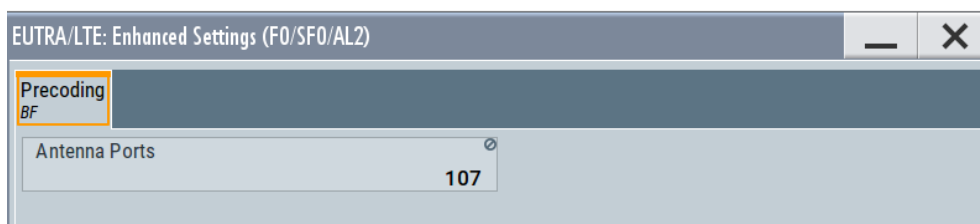

10. Select "Frame Configuration > Timeplan" to observe the EPDCCH configuration.

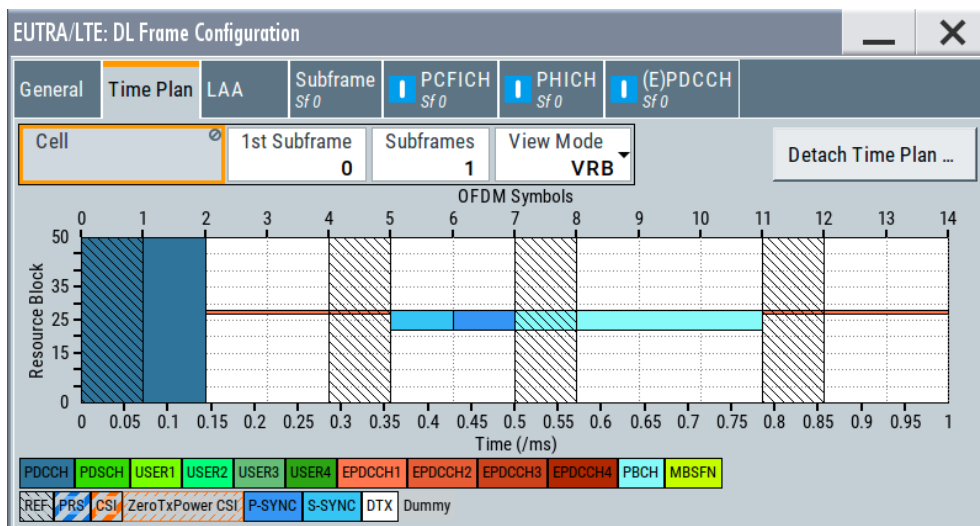

The display confirms that the EPDCCH is transmitted in the data region of the frame and it does not span the full system bandwidth. The EPDCCH is transmitted over a set of four narrow non-contiguous physical resource blocks (PRB).

The number of displayed EPDCCH pairs per UE depends on the following:

- Number of PRB pairs per EPDCCH set.
- Number of active EPDCCH sets.
The two EPDCCH sets of one UE are indicated with the same color.
- If and which EPDCCH set is allocated ("Frame Configuration > E(DPCCH) > User x > (E)EPDCCH > EPDCCH Set x")
At least one DCI must be assigned to an EPDCCH.
- EPDCCH transmission type
- Resource block allocation per EPDCCH set.
EPDCCH may partly overlap.
- Amount of DCI information (assigned ECCEs) carried in an EPDCCH with two PRB pairs and localized transmission.
If the DCI information is not sufficient to fill all available EPDCCH PRBs, the unallocated PRBs can be used for PDSCH transmission.

Settings:

Activate EPDCCH..... 150

Set 1/2 State..... 150

Transmission Type..... 150

Number of PRB Pairs..... 150

Resource Block Assignment..... 151

N ^A EPDCCH_ID.....	151
Relative EPDCCH Power.....	151
Hopping.....	151
Starting NB.....	151
Max. Repetitions MPDCCH (Rmax).....	151
Search Space Start Subframe.....	152

Activate EPDCCH

If "General DL Settings > Scheduling" > "Auto/DCI", enables the EPDCCH transmission for the select user and component carrier.

EPDCCH cannot be activated in manual mode ("Scheduling > Manual").

Option: R&S SMM-K115

The EPDCCH and EPDCCH set 1 are always active.

Remote command:

```
[ :SOURCE<hw> ] :BB:EUTRa:DL:USER<ch>:EPDCch:CELL<st0>:STATe
on page 740
```

Set 1/2 State

Enables the EPDCCH set.

To allocate an EPDCCH set, select "Frame Configuration > E(DPCCH) > User x > (E)EPDCCH > EPDCCH Set 1/2".

Option: R&S SMM-K115

The EPDCCH and EPDCCH set 1 are always active.

Remote command:

```
[ :SOURCE<hw> ] :BB:EUTRa:DL:USER<ch>:EPDCch:CELL<st0>:SET<dir>:
STATe on page 740
```

Transmission Type

Select whether localized or distributed EPDCCH transmission is used.

- | | |
|---------------|------------------------------------------------------------------------------------------------------------------------------------------------------------------------------------------------------------------------------------------------------|
| "Localized" | Subsequent EREGs are allocated within the same PRB as long as there are physical resources available.
Localization transmission is useful if the channel conditions are known, so that the scheduling and MIMO precoding can be optimized. |
| "Distributed" | EREGs are allocated in the separate (subsequent) PRBs.
This transmission type applies frequency diversity and distributed the REGs among the available channel bandwidth. Distributed transmission is used if the channel conditions are unknown. |

Remote command:

```
[ :SOURCE<hw> ] :BB:EUTRa:DL:USER<ch>:EPDCch:CELL<st0>:SET<dir>:
TTYp on page 740
```

Number of PRB Pairs

Sets the number of physical resource block (PRB) pairs.

Per PRB pair, there are 16 enhanced resource element groups (EREG), that are numbered from 0 to 15.

Observe the [OFDMA time plan](#)

Remote command:

```
[ :SOURCE<hw> ] :BB:EUTRa:DL:USER<ch>:EPDCch:CELL<st0>:SET<dir>:  
PRBS on page 741
```

Resource Block Assignment

Shifts the EPDCCH allocations in the frequency domain and defines the resource blocks used for the EPDCCH transmission.

The EPDCCH PRBs are distributed among the available resource blocks according to [TS 36.213](#).

Remote command:

```
[ :SOURCE<hw> ] :BB:EUTRa:DL:USER<ch>:EPDCch:CELL<st0>:SET<dir>:RBA  
on page 741
```

N[^]EPDCCH_ID

Unlike the PDCCH that is a cell-specific control channel, the EPDCCH is a user-specific control channel.

This parameter sets the user-specific identifier $n_{ID,m}^{EPDCCH}$ used to initialize the DMRS scrambling sequences of the EPDCCH sets.

Remote command:

```
[ :SOURCE<hw> ] :BB:EUTRa:DL:USER<ch>:EPDCch:CELL<st0>:SET<dir>:NID  
on page 741
```

Relative EPDCCH Power

Sets the power of the EPDCCH allocations.

The value is applied relative to the value of the parameter [Reference Signal Power](#).

Remote command:

```
[ :SOURCE<hw> ] :BB:EUTRa:DL:USER<ch>:EPDCch:CELL<st0>:SET<dir>:  
POWer on page 742
```

Hopping

Option: R&S SMM-K115

Enables MPDCCH hopping.

Remote command:

```
[ :SOURCE<hw> ] :BB:EUTRa:DL:USER<ch>:EPDCch:CELL<st0>:SET<dir>:  
HOPPIng on page 891
```

Starting NB

Option: R&S SMM-K115

Sets the first narrowbands in which MPDCCH is allocated.

Remote command:

```
[ :SOURCE<hw> ] :BB:EUTRa:DL:USER<ch>:EPDCch:CELL<st0>:SET<dir>:  
STNB on page 892
```

Max. Repetitions MPDCCH (Rmax)

Option: R&S SMM-K115

Sets the maximum number the MPDCCH is repeated.

The actual number of repetitions is calculated as function of the repetition level, as described in "[MPDCCH repetition number](#)" on page 339.

Remote command:

```
[ :SOURCE<hw> ] :BB:EUTRa:DL:USER<ch>:EPDCch:CELL<st0>:SET<dir>:
REPMpdcch on page 892
```

Search Space Start Subframe

Option: R&S SMM-K115

Sets the first subframe of the search space.

Remote command:

```
[ :SOURCE<hw> ] :BB:EUTRa:DL:USER<ch>:EPDCch:CELL<st0>:SET<dir>:
STSF on page 892
```

4.3.6 Scrambling configuration settings

(requires R&S SMM-K112)

Access:

1. Select "General > Link Direction > Downlink (OFDMA)"
2. Select "Frame Configuration > General > User"
3. Select "User# > Tx Modes > Mode 10"
4. Select "User# > Scrambling > Config"

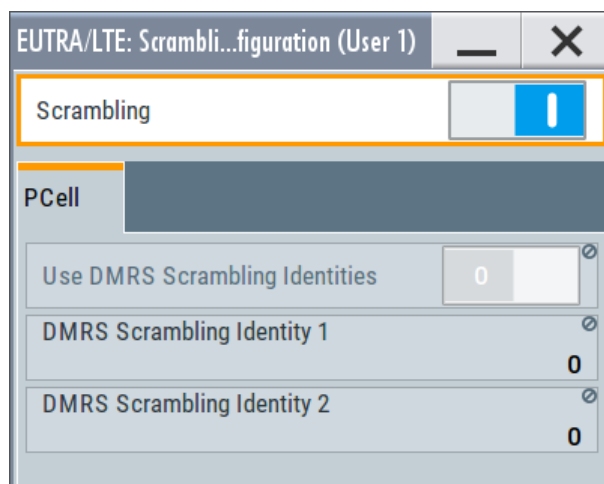

With option R&S SMM-K112, you can enable and configure the scrambling parameters for the selected user.

If DL carrier aggregation is used, the scrambling parameters are configured per component carrier. The scrambling state, however, applies to all component carriers.

Settings:

Scrambling State.....	153
Use DMRS Scrambling Identities.....	153
DMRS Scrambling Identity 1/2.....	153

Scrambling State

Enables/disables scrambling for all allocations belonging to the selected user.

The parameter "Scrambling State" determines the "Enhanced Settings > Scrambling State" of all allocations for which you select the **Data Source** = "User x".

Remote command:

[:SOURCE<hw>] :BB:EUTRa:DL:USER<ch>:SCRambling:STATe on page 737

Use DMRS Scrambling Identities

Sets if one or two scrambling identities are used for the demodulation reference signals (DMRS).

See "[Coordinated multi-point operation for LTE \(CoMP\)](#)" on page 50.

To set the n_{CSID} , use the parameters [DCI Format 2/2A/2B/2C/2D](#) and [Scrambling Identity \$n_{\text{SCID}}\$](#) .

"Off" The DRMS sequence is generated with the variable $n_{\text{ID}} = N_{\text{ID}}^{\text{cell}}$, where $N_{\text{ID}}^{\text{cell}}$ is the physical cell identity (PCI).

"On" $n_{\text{ID}} = n_{\text{ID}}^{\text{DMRS},i}$, i.e. two DRMS scrambling identities are used. Set the values with the parameters [DMRS Scrambling Identity 1/2](#).

Remote command:

[:SOURCE<hw>] :BB:EUTRa:DL:USER<ch>:SCRambling:CELL<st>:DMRS:USE on page 737

DMRS Scrambling Identity 1/2

Sets the DMRS scrambling identities $n_{\text{ID}}^{\text{DMRS},i}$.

Remote command:

[:SOURCE<hw>] :BB:EUTRa:DL:USER<ch>:SCRambling:CELL<st>:DMRS:ID1 on page 738

[:SOURCE<hw>] :BB:EUTRa:DL:USER<ch>:SCRambling:CELL<st>:DMRS:ID2 on page 738

4.3.7 SPS configuration settings

Access:

1. Select "General > Link Direction > Downlink (OFDMA)"
2. Select "Frame Configuration > General > User"

3. Select "User# > SPS > Config"

With the provided settings, you can enable and configure a semi-persistent scheduling (SPS) for the selected user.

Semi-persistent scheduling is a scheduling method used to reduce the control signaling overhead for regularly occurring services and transmissions of relative small payloads, see "[Uplink scheduling](#)" on page 39.

Related parameters

In this firmware, the configuration, the activation and the deactivation of an SPS transmission is implemented as following:

- Configuration of the SPS pattern is defined by:
 - [SPS Interval](#)
 - [SPS C-RNTI](#)
 - [Activate SPS](#)
- Activation of the SPS is defined by:
 - [Activation Subframe No](#)
 - [Config PDCCH](#) > "PDCCH Activation Subframe# > DCI Table > User > User x SPS > DCI Format" and "Content Act. > DCI Format Configuration > Special fields"
- Transmission
Observe the scheduling in the [OFDMA time plan](#)
- Release of the SPS is defined by:
 - [Release Subframe No](#)
 - "Config PDCCH > PDCCH Release Subframe# > DCI Table > User > User x SPS > Content Rel > DCI Format Configuration > Special fields"

How to configure an SPS for User 1 and visualize the scheduling

The following is a simple example that demonstrates the necessary configuration steps and lists only the related settings. Setting beyond the scope of this example are not discussed.

To enable a semi-persistent scheduling

1. Select "EUTRA/LTE > Filter/Clipping/ARB > ARB Sequence Length = 3 Frames".
2. Select "EUTRA/LTE > General DL Settings > PDSCH Scheduling > Auto/DCI".
3. Select "EUTRA/LTE > Frame Configuration" and enable "Number of Configurable Subframes = 30".
4. Select "Frame Configuration > User".
Enable "User 1 > SPS > Config".
5. In the "SPS Configuration" dialog, enable "SPS Interval = SF 10", "Activation Subframe No = 2" and "Release Subframe No = 14".

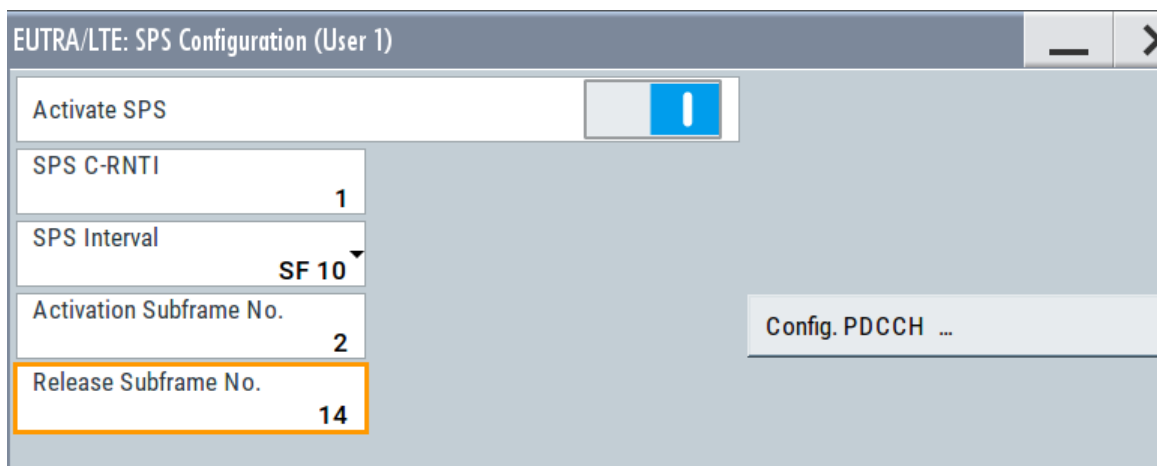

The User 1 is scheduled to start transmission in the subframe#2 and release it in subframe#14. The SPS interval is 10 subframes. If the DCIs are configured correctly, the User 1 transmits in subframe#2 and subframe#12.

6. In the "SPS Configuration" dialog, select "Config. PDCCH".
The "Frame Configuration" dialog opens and the "DCI Table" displays the PDCCH settings of subframe#2.

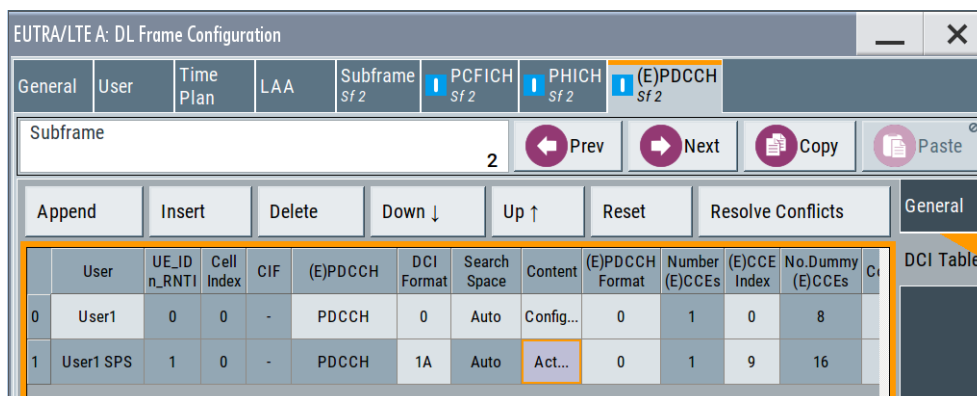

The second PDCCH item in the DCI table confirms that the User 1 is semi-persistent scheduled ("User > User 1 SPS") and subframe#2 is the activation subframe of this SPS ("User 1 SPS > Content > Act.").

- In the "DCI Table", select "User 1 SPS > Content > Act."

The "DCI Configuration" dialog for DCI Format 1A opens. As defined in TS 36.213, some fields are predefined.

- Adjust the DCI fields, for example set "Resource Block Assignment = 300" and "Modulation and Coding Scheme = 15".

Note: In any SPS activation subframe, the maximum value allowed for the Modulation and Coding Scheme is 15; this corresponds to 0111 in binary form and is according to the requirements defined in TS 36.213.

See also Table 4-4.

- In the "Frame Configuration > PDCCH" dialog, select "Subframe = 14". Observe the "DCI Table".

	User	UE_ID n_RNTI	Cell Index	CIF	(E)PDCCH	DCI Format	Search Space	Content	(E)PDCCH Format	Number (E)CCEs	(E)CCE Index	No.Dummy (E)CCEs	C
0	User1	0	0	-	PDCCH	0	Auto	Config...	0	1	0	7	
1	User1 SPS	1	0	-	PDCCH	1A	Auto	Rel...	0	1	8	17	

The second PDCCH item in the DCI table confirms that the User 1 is semi-persistent scheduled ("User > User 1 SPS") and subframe#14 is the release subframe of this SPS ("User 1 SPS > Content > Rel.>").

- In the "DCI Table", select "User 1 SPS > Content > Rel."

The "DCI Configuration" dialog for DCI Format 1A opens. The DCI fields are set as defined in TS 36.213; compare with the values in Table 4-4.

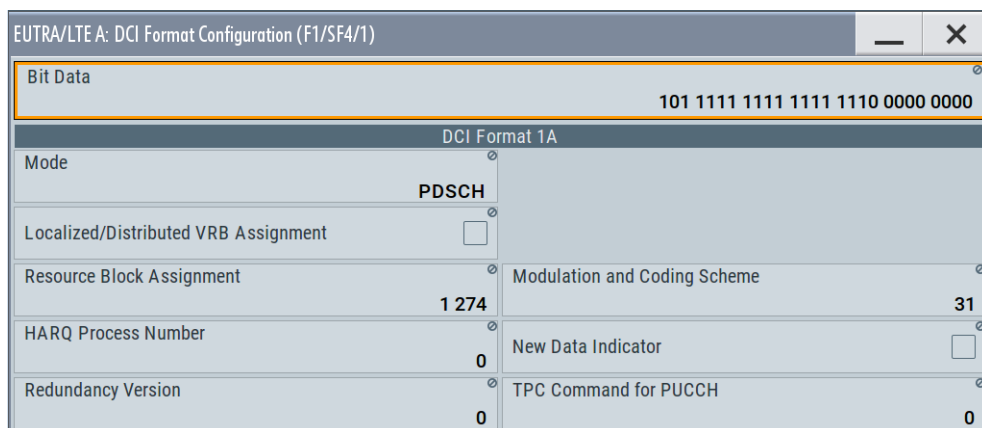

11. Open "Frame Configuration > OFDMA Timeplan" and enable:

- a) "No of Subframes = 20"
- b) "First Subframe = 0"

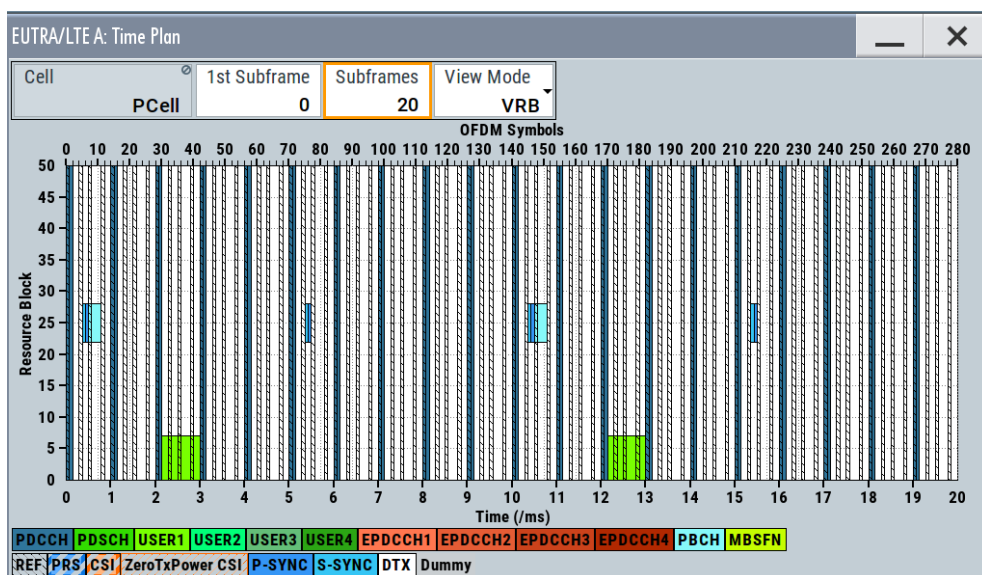

The time plan confirms User 1 transmission in subframe#2 and subframe#12.

12. Select "First Subframe = 10" to display the time plan of subframe#10 to subframe#20.

There are no more subframes allocated to User 1; The SPS is released in subframe#14.

Activate SPS..... 158

SPS C-RNTI..... 158

SPS Interval..... 158

Activation/Release Subframe No..... 158

Config PDCCH..... 158

Activate SPS

Enables you to configure an SPS (semi-persistence scheduling) for the selected UE and triggers the instrument to generate the required DCIs.

Define the SPS pattern ([SPS Interval](#)) and select the exact subframe the SPS transmission starts and stops ([Activation/Release Subframe No](#)).

Remote command:

`[:SOURCE<hw>] :BB:EUTRa:DL:USER<ch>:SPS:STATe` on page 744

SPS C-RNTI

Sets the SPS C-RNTI parameter.

Remote command:

`[:SOURCE<hw>] :BB:EUTRa:DL:USER<ch>:SPS:CRNTi` on page 745

SPS Interval

Defines the SPS interval as number of subframes (SF).

Remote command:

`[:SOURCE<hw>] :BB:EUTRa:DL:USER<ch>:SPS:SINTerval` on page 745

Activation/Release Subframe No

Defines the start and end subframes of the semi-persistent scheduling (SPS).

The UE validates an activation/deactivation request for an SPS only if the DCI fields are set as required, see "[Config PDCCH](#)" on page 158.

Remote command:

`[:SOURCE<hw>] :BB:EUTRa:DL:USER<ch>:SPS:SACTivation` on page 745

`[:SOURCE<hw>] :BB:EUTRa:DL:USER<ch>:SPS:SRELease` on page 745

Config PDCCH

Accesses the [\(E\)PDCCH format variable](#) dialog for configuring the required DCI settings in the activation subframe.

The UE validates an activation/deactivation request for an SPS only if the DCI fields are set according to Tables 9.2 in [TS 36.213](#). The [Table 4-4](#) is an example of the DCI format 1A fields (see also "[DCI Format 1A](#)" on page 192).

Table 4-4: PDCCH DCI format 1A fields for SPS activation and release/deactivation validation

Bit field	SPS activation value	SPS release value
"HARQ Process Number"	0	0
"Modulation and Coding Scheme"	0 .. 15	31
"Redundancy Version"	0	0
"Resource Block Assignment"	-	Set to all "1"

4.3.8 LAA settings

Option: R&S SMM-K119

Access:

1. Select "General > Link Direction > Downlink (OFDMA)".
2. Select "General DL Settings > Scheduling PDSCH Scheduling" > **"Auto/DCI or Auto Sequence"**.
3. Enable at least on LAA SCell, for example select "General DL Settings > CA > SCell#1 > Duplexing" > **"LAA"**.
4. To configure the discovery reference signals:
 - a) Select "General DL Settings > Signals > DRS"
 - b) For example set, "SCell#1 > State = On", "Periodicity = 40", "Duration = 1", "Offset = 1" and "Pattern = 0".

The DMTC occasion has a periodicity of 40 s. The DRS is 1 ms long and allocated in the subframe#1 of the DMTC occasion, because "Pattern = 0" but "Offset = 1".

For more information, see ["Discovery reference signal \(DRS\)"](#) on page 56.

See also [Chapter 4.2.7.5, "Discovery reference signals \(DRS\) settings"](#), on page 115.

5. Select "General > DL Frame Configuration" > **"LAA"**.
6. Select "LAA Cell = SCell 1 (Index 1)", i.e. one of the SCell configured as LAA cells in the DL carrier aggregation "CA" dialog.
7. Enable at least one LAA burst, e.g. set "Number of LAA Bursts = 1".
8. Configure the LAA burst in terms of start and end subframe, burst duration and DCI mode.

Burst Index	Starting Subframe	Starting Symbol	Burst Duration /ms	Number of Ending Symbols	Ending Subframe	LAA DCI 1C Mode	(E)PDCCH Format
0	5	s7	3	11	8	(n-1) & n	2

9. Observe the LAA SCell allocation on the "Time Plan".

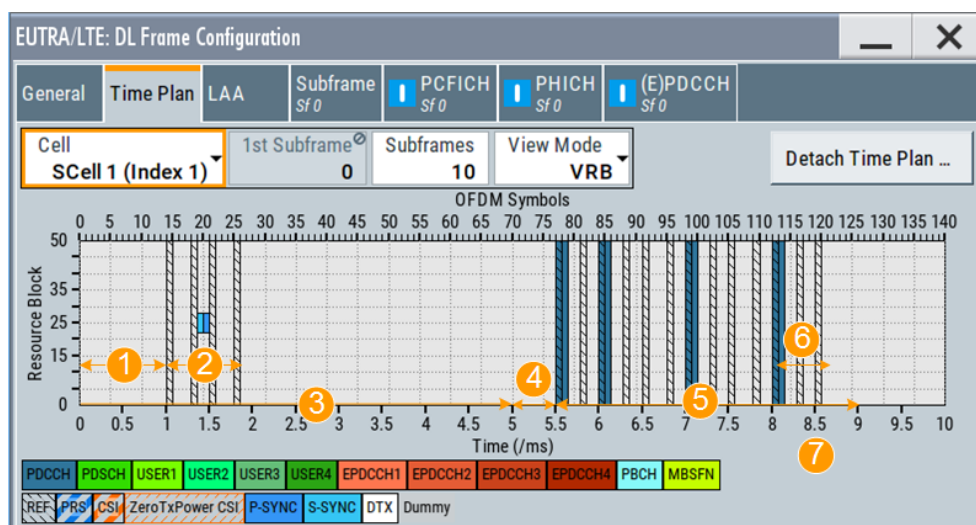

Figure 4-10: LAA burst: understanding the displayed information

- 1 = "DRS Offset = 1"
 - 2 = "DRS Duration = 1 ms"
 - 3 = "LAA burst "Starting Subframe = 5", i.e. LAA burst start at subframe#5 of each frame"
 - 4 = "Starting Symbol = s7", i.e. the LAA partial subframe starts at the boundary of the second symbol within the LAA starting subframe"
 - 5 = "Burst Duration = 3 ms", where the starting LAA subframe is a partial subframe and the last (ending) subframe contains 11 ending OFDM symbols"
 - 6 = "Number of Ending Symbols = 11" (not all symbols are used)"
 - 7 = "Ending Subframe = Starting Subframe + Burst Duration = 8"
- Subframes = 10

10. To configure the DCI format 1C:

- a) Select "General > DL Frame Configuration > LAA > LAA DCI 1C Mode = e.g. (n-1)&n"
- b) Select "(E)PDCCH > User = CC-RNTI"
- c) For "DCI Format > 1C", select "Content > Config".
- d) Set the field "Subframe Configuration for LAA".

11. Adjust the "ARB Sequence Length" according to ["How to set the ARB sequence length for signals composed of DRSs with different periodicity"](#) on page 116.

For background details, see [Chapter 2.2.8, "LTE Release 13/14 introduction"](#), on page 53

The remote commands required to define these settings are described in [Chapter 10.14, "LAA and DRS"](#), on page 637.

Settings:

LAA Cell	161
Number of LAA Bursts	161
Burst Index	161
Starting Subframe	161
Starting Symbol	161
Burst Duration (ms)	161

Number of Ending Symbols.....	161
Ending Subframe.....	162
LAA DCI 1C Mode.....	162
(E)PDCCH Format.....	162

LAA Cell

Selects the LAA SCell for that the LAA is configured.

Remote command:

[:SOURCE<hw>] :BB:EUTRa:DL:LAA:CEINDEX on page 644

Number of LAA Bursts

You can configure up to 10 LAA bursts per LAA SCell.

Remote command:

[:SOURCE<hw>] :BB:EUTRa:DL:LAA:CELL<ch0>:NUMBURSTS on page 644

Burst Index

Consecutive number indicating the LAA bursts.

Starting Subframe

Sets the first subframe of the LAA burst.

See:

- [Figure 4-10](#)
- [Chapter 2.2.8.1, "Frame structure type 3 \(LAA\) and partial subframes"](#), on page 54.

Remote command:

[:SOURCE<hw>] :BB:EUTRa:DL:LAA:CELL<ch0>:BURSt<st0>:STSFrame
on page 645

Starting Symbol

Defines the time point the LAA burst started:

- "s0": LAA burst starts at the LTE subframe boundary (subframeStartPositon), i.e. at the **first slot** of a subframe
- "s7": LAA burst starts at the boundary of the **second slot** of a subframe (secondSlotStartingPositon)

Remote command:

[:SOURCE<hw>] :BB:EUTRa:DL:LAA:CELL<ch0>:BURSt<st0>:STSLOT
on page 645

Burst Duration (ms)

Sets the duration of the LAA burst.

Remote command:

[:SOURCE<hw>] :BB:EUTRa:DL:LAA:CELL<ch0>:BURSt<st0>:DURATION
on page 645

Number of Ending Symbols

Sets the number of OFDM symbols in the last subframe of the LAA burst.

Remote command:

[:SOURCE<hw>] :BB:EUTRa:DL:LAA:CELL<ch0>:BURSt<st0>:LSFSymbols
on page 646

Ending Subframe

Indicates the number of the last subframe of the LAA burst. The value is calculated as follows:

Indicates the number of the last subframe of the LAA burst. The value is calculated as follows:

- For "Starting Symbol = s0"
"Ending Subframe" = "Starting Subframe" + "Burst Duration" - 1
- For "Starting Symbol = s7"
"Ending Subframe" = "Starting Subframe" + "Burst Duration"

Remote command:

[:SOURCE<hw>] :BB:EUTRa:DL:LAA:CELL<ch0>:BURSt<st0>:ENSFrame?
on page 646

LAA DCI 1C Mode

Defines how the DCI format 1C is sent.

Assuming n is the last subframe, DCI format 1C can be sent in the following ways:

- "(n-1)"
DCI is present in the **next-to-last subframe** (n-1).
- "n"
DCI is present in the **last subframe** n .
If "Subframe Configuration for LAA < 14", no other physical channels are sent in subframe n
- "(n-1)&n"
DCI present in both **n and n-1** subframes
Both subframe have to use identical subframe configuration.
- "Manual"

Remote command:

[:SOURCE<hw>] :BB:EUTRa:DL:LAA:CELL<ch0>:BURSt<st0>:C1Mode
on page 646

(E)PDCCH Format

For "LAA DCI 1C Mode" different than "Manual", sets the (E)PDCCH format and defines how many (E)CCEs are used for the transmission of the (E)PDCCH.

See also "(E)PDCCH Format (Variable)" on page 188.

Remote command:

[:SOURCE<hw>] :BB:EUTRa:DL:LAA:CELL<ch0>:BURSt<st0>:EPDCch
on page 647

4.3.9 Subframe configuration settings

Access:

1. Select "General > Link Direction > Downlink (OFDMA)".
2. Select "General DL Settings > Scheduling > Manual".
3. Select "General > Frame Configuration".
4. To access the common subframe configuration settings, select one of the following:
 - "Frame Configuration > Subframe"
 - "Frame Configuration > PCFICH"
 - "Frame Configuration > PHICH"
 - "Frame Configuration > PDCCH"

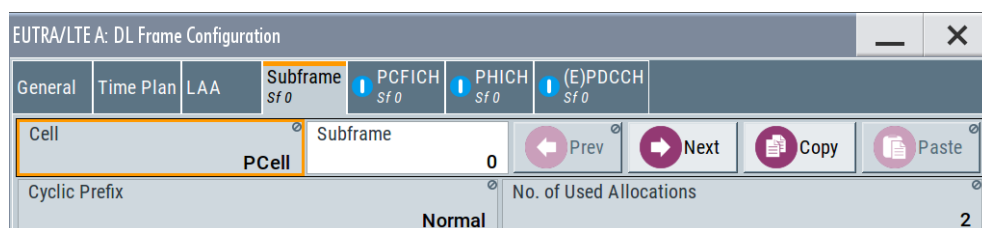

Provided are the following common settings:

Cell.....	163
Subframe Selection.....	163
Cyclic Prefix.....	163
No. Of Used Allocations.....	164
Copy/Paste.....	164
Next/Prev.....	164

Cell

With enabled "General DL Settings > CA > Activate Carrier Aggregation > On" state, indicates to which cell (i.e. component carrier) the settings apply.

Remote command:

n.a

Subframe Selection

Sets the subframe to be configured in the frame configuration table.

Remote command:

n.a

Cyclic Prefix

Configuration of the cyclic prefix per subframe is only enabled, if the parameter [Cyclic Prefix](#) is set to User Defined.

The number of the OFDM symbols per subframe is set automatically.

Remote command:

`[:SOURce<hw>] :BB:EUTRa:DL [:SUBF<st0>] :CYCPrefix` on page 605

No. Of Used Allocations

Sets the number of scheduled allocations in the selected subframe.

The number of available allocations depends on the allocation's content type for a subframe and the general channel bandwidth setting.

The default value depends on the existence of a PBCH channel in a subframe. In this case, the default value is set to 2, otherwise to 1. The second or the first allocation is reserved for the PDCCH, regardless whether this allocation is enabled or not.

Remote command:

[:SOURce<hw>] :BB:EUTRa:DL [:SUBF<st0>] :ALCount on page 606

Copy/Paste

Copies/pastes the settings of the selected subframe. P-SYNC/S-SYNC/PBCH settings are not considered.

For more detailed information, see [Chapter B.1, "Copy/paste subframe"](#), on page 948.

Remote command:

n.a.

Next/Prev

Navigates through the subframes.

Remote command:

n.a.

4.3.10 DL resource allocation table

Access:

1. Select "General > Link Direction > Downlink (OFDMA)".
2. Select "General Settings > Scheduling > Manual".
3. In the "General" tab, select "Frame Configuration > Subframe".

	CW	Modulation	Enhanced Settings	VRB Gap	No. RB	No. Sym.	Offset RB	Offset Sym.	Auto	Phys. Bits	Data Source	DList / Pattern	ρ A /dB	Content Type	State	Conflict
0	1/1	QPSK	Config...	-	6	4	22	7(1/0)	<input type="checkbox"/>	480	MIB	-	0.000	PBCH	On	
1	1/1	QPSK		-	50	2	0	0(0/0)	<input type="checkbox"/>	1520	PDCCH	-	0.000	PDCCH	On	
2.1	1/2	QPSK	Config...	-	10	12	0	2(0/2)	<input checked="" type="checkbox"/>	5120	PN11	-	5.000	PDSCH	On	
2.2	2/2	64QAM	Config...	-	10	12	0	2(0/2)	<input checked="" type="checkbox"/>	15360		-			On	
3.1	1/2	QPSK	Config...	-	5	12	10	2(0/2)	<input checked="" type="checkbox"/>	1160	User1	-	0.000	PDSCH	On	
3.2	2/2	QPSK	Config...	-	5	12	10	2(0/2)	<input checked="" type="checkbox"/>	1160		-			On	
4.1	1/2	QPSK	Config...	-	25	12	15	2(0/2)	<input checked="" type="checkbox"/>	9152	User2	-	0.000	PDSCH	On	
4.2	2/2	256QAM	Config...	-	25	12	15	2(0/2)	<input checked="" type="checkbox"/>	36608		-			On	

The resource allocation table comprises the settings necessary to configure the individual allocation parameters for a subframe.

Allocation number.....	165
Codeword.....	165
Modulation.....	165
Enhanced Settings.....	165
VRB Gap.....	166
No. RB (Resource Blocks).....	167
No. Sym.....	167
Offset RB.....	168
Offset Sym.....	168
Auto.....	169
Phys. Bits.....	169
Data Source.....	169
Rho A.....	170
Content Type.....	170
State.....	170
Conflict.....	171

Allocation number

Displays the consecutive number of the allocation.

Remote command:

n.a.

Codeword

Determines whether one or two codewords use the same physical resource, and whether codeword 1/2 or 1/2 is configured with this allocation table entry

In case the data source for an allocation is set to User, changing this parameter sets also the parameter "Codeword" of all allocations, belonging to the same User in the subframe.

Remote command:

`[:SOURce<hw>] :BB:EUTRa:DL [:SUBF<st0>] :ALLoc<ch0>:CODWords`
on page 606

Modulation

Selects the modulation scheme for the allocation.

In case the data source for an allocation is set to User, changing this parameter sets also the parameter "Modulation" of all allocations, belonging to the same User in the subframe.

Remote command:

`[:SOURce<hw>] :BB:EUTRa:DL [:SUBF<st0>] :ALLoc<ch0>[:CW<user>] :`
`MODulation` on page 606

Enhanced Settings

Opens the "Enhanced Settings" dialog for configuration of precoding and channel coding (see [Chapter 4.4, "Enhanced PBCH, PDSCH and PMCH settings"](#), on page 202).

Remote command:
n.a.

VRB Gap

Enables the utilization of virtual resource blocks (VRB) of distributed type and determines whether the first or the second gap is applied. That is, it determines the distribution and the mapping of the VRB pairs to the physical resource blocks (PRB) pairs.

The VRB-to-PRB mapping and the calculation of the VRB gap values are performed according to [TS 36.211](#). The specification defines two types of VRBs, a localized distribution with a direct mapping and distributed VRBs for better frequency diversity. The distribution of the VRBs is performed in such a way, that consecutive VRBs are not mapped to frequency-consecutive PRBs. The VRBs are spread over the frequencies instead. Each single VRB pair is split into two parts and a frequency gap between these two VRB parts is introduced. That is, a frequency hopping on a slot basis is applied. For wider channel bandwidths (more than 50 RBs), a second VRB gap with smaller size may be applied.

Tip: Use the "DL Time Plan" to visualize the PDSCH mapping.

The information whether localized or distributed VBRs are applied is carried by the PDCCH. The DCI Formats [1A/1B/1D](#) provide the special 1-bit flag "Localized/Distributed VBR Assignment" for this purpose. The selection whether the first or the second gap is applied, is determined by the additional bit "Gap Value".

Note: In case a "General DL Settings > Scheduling > PDSCH Scheduling > Auto/DCI" mode is used, the "VRB Gap" value is read-only and is set according to the configuration of the corresponding DCI format.

Example:

"DL Channel Bandwidth = 10 MHz" (50 RBs)

Three subframes are configured:

- Subframe#0
 - PDSCH allocation#2 (User2): "VRB Gap = 0"
 - PDSCH allocation#3 (User4): "VRB Gap = 0"

	CW	Mod.	Enh. Sett.	VRB Gap	No. RB	No. Sym.	Offs RB	Offs Sym.	Auto	Phys. Bits	Data Source	DList / Pattern	ρ A /dB	Content Type	State	Conf
0	1/1	QPSK	Config...	-	6	4	22	7(1/0)	<input type="checkbox"/>	480	MIB	-	0.000	PBCH	On	
1	1/1	QPSK		-	50	2	0	0(0/0)	<input type="checkbox"/>	1920	PDCCH	-	0.000	PDCCH	On	
2	1/1	QPSK	Config...	-	1	12	0	2(0/2)	<input checked="" type="checkbox"/>	276	User2	-	0.000	PDSCH	On	
3	1/1	QPSK	Config...	-	1	12	1	2(0/2)	<input checked="" type="checkbox"/>	276	User4	-	0.000	PDSCH	On	

- Subframe#1
 - PDSCH allocation#2 (User2): "VRB Gap = 1"
 - PDSCH allocation#3 (User4): "VRB Gap = 1"
 - Both allocations use distributed VRBs; the first VRB gap is applied.

According to [TS 36.211](#), the first VRB gap for 10 MHz channel bandwidth is **27 RBs**

- Subframe#2

- PDSCH allocation#2 (User2): "VRB Gap = 1"
- PDSCH allocation#3 (User4): "VRB Gap = 2"
- Both allocations use distributed VRBs. The first VRB gap is applied for PDSCH allocation#2 (User2) and the second VRB gap for the allocation#3 (User4) .

According to [TS 36.211](#), the second VRB gap for 10 MHz channel bandwidth is **9 RBs**

Use the "DL Time Plan" to visualize the PDSCH mapping.

- | | |
|-----|-----------------------------------------------------------------------------------------------------------------|
| "0" | A localized distribution is applied, i.e. the PDSCH mapping is performed on a direct VRB-to-PRB mapping. |
| "1" | Enables a distributed resource block allocation. The first VRB gap is used. |
| "2" | Enabled for "Channel Bandwidths" greater than 50 RBs. The mapping is based on the second (smaller) VRB gap. |

Remote command:

```
[ :SOURCE<hw> ] :BB:EUTRa:DL [ :SUBF<st0> ] :ALLoc<ch0> [ :CW<user> ] :GAP
```

on page 607

No. RB (Resource Blocks)

Defines the bandwidth of selected allocation in terms of resource blocks per slot.

In case two codewords are configured, the defined bandwidth of the allocation with the second codeword is determinate by the selected bandwidth of the first one.

"Auto" indicates automatically calculated value depending on other settings, like the "Content type".

Remote command:

```
[ :SOURCE<hw> ] :BB:EUTRa:DL [ :SUBF<st0> ] :ALLoc<ch0> [ :CW<user> ] :RBCount
```

on page 607

No. Sym.

Sets the size of the selected allocation in OFDM symbols.

For FDD mode and content type PDSCH, this value is set automatically in a way that the allocation always fills the complete subframe with consideration of the symbol offset.

Example:

For Cyclic Prefix with normal length (14 OFDMA Symbols) and Symbol Offset = 2 the resulting "No. Of Symbols" is 12.

In case two codewords are configured, the size of the allocation with the second codeword is determinate by the size of the first one.

While configuring a special subframe for TDD mode, the maximum size of the PDSCH allocation is determined by the selected [TDD frame structure settings](#) and depends on the selected [Cyclic Prefix](#).

The following table shows the cross-reference between the special subframe configuration and the maximum number of OFDM symbols available for PUSCH (DwPTS) in a special subframe for normal and extended CP.

Configuration of Special Sub-frame	DwPTS (Normal CP)	DwPTS (Extended CP)
0	3	3
1	9	8
2	10	9
3	11	10
4	12	3
5	3	8
6	9	9
7	10	5
8	11	-
9	6	-

Remote command:

```
[ :SOURCE<hw> ] :BB:EUTRa:DL [ :SUBF<st0> ] :ALLoc<ch0> [ :CW<user> ] :
SYMCOUNT on page 608
```

Offset RB

Sets the start resource block of the selected allocation.

The value is:

- **Read only:** if "Auto Offset Calculation > On"
- In case two codewords are configured, the start resource block of the allocation with the second codeword is determined by the selected start resource block of the first one.
- **"Auto":** if automatically calculated depending on other settings, like the "Content type".

Remote command:

```
[ :SOURCE<hw> ] :BB:EUTRa:DL [ :SUBF<st0> ] :ALLoc<ch0> [ :CW<user> ] :
RBOFFSET on page 608
```

Offset Sym.

Sets the start OFDM symbol of the selected allocation.

Note: If the "Auto Offset Calculation" mode is activated, this value is read only.

For extended cyclic prefix, the maximum symbol offset is 13.

Note: According to [TS 36.211](#), up to first three OFDM symbols of a subframe are reserved for control information (PDCCH). Therefore, for PDSCH allocations the maximum value is 3, regardless of the cyclic prefix length.

In case two codewords are configured, the start OFDM symbol of the allocation with the second codeword is determined by the selected start OFDM symbol of the first one.

Remote command:

```
[ :SOURCE<hw> ] :BB:EUTRa:DL [ :SUBF<st0> ] :ALLoc<ch0> [ :CW<user> ] :
SYMoffset on page 608
```

Auto

Sets whether automatic offset calculation is used or not.

Note: If the "Auto Offset Calculation" mode is activated, the resource block offset and the start symbol offset are set automatically and cannot be changed.

By setting new allocations or changing the number of RBs of an existing allocation, the Auto mode tries to distribute the allocations with activated Auto mode in an optimal manner to the available resource blocks by adjusting the parameters "Offset RB". The resulting "No. of Bits" of a certain allocation can vary, due to overlapping control channels.

If it is not possible to distribute the changed configuration to the available resources blocks, a conflict is displayed.

Note: "Auto Offset Calculation" mode is only available for PDSCH. For PDCCH, this parameter is always off.

In case two codewords are configured, the state of the "Auto Offset Calculation" mode of the second codeword is set to the state of the first one.

Remote command:

```
[ :SOURCE<hw> ] :BB:EUTRa:DL [ :SUBF<st0> ] :ALLoc<ch0> [ :CW<user> ] :AOC
on page 609
```

Phys. Bits

Displays the size of the selected allocation in bits and considering the subcarriers that are used for other signals or channels with higher priority.

See [Chapter A, "Conflict handling"](#), on page 943.

"Auto" indicates automatically calculated value depending on other settings, like the "Content type".

Remote command:

```
[ :SOURCE<hw> ] :BB:EUTRa:DL [ :SUBF<st0> ] :ALLoc<ch0> [ :CW<user> ] :
PHYSbits? on page 609
```

Data Source

Selects the data source for the selected allocation.

For PBCH allocation with enabled parameter [MIB \(including SFN\)](#), the "Data Source = MIB" is used.

If MBSFN is used, the data source of the allocations in the MBSFN subframes is set to MCCH or MTCH depending on the MBSFN configuration.

Use the [User configuration settings](#) dialog to configure the data sources for "User x".

The following standard data sources are available:

- "All 0, All 1"
An internally generated sequence containing 0 data or 1 data.
- "PNxx"
An internally generated pseudo-random noise sequence.
- "Pattern"

An internally generated sequence according to a bit pattern.

Use the "Pattern" box to define the bit pattern.

- "Data List/Select DList"

A binary data from a data list, internally or externally generated.

Select "Select DList" to access the standard "Select List" dialog.

- Select the "Select Data List > navigate to the list file *.dm_iqd > Select" to select an existing data list.
- Use the "New" and "Edit" functions to create internally new data list or to edit an existing one.
- Use the standard "File Manager" function to transfer external data lists to the instrument.

See also:

- Section "Modulation Data" in the R&S SMM100A user manual.
- Section "File and Data Management" in the R&S SMM100A user manual.
- Section "Data List Editor" in the R&S SMM100A user manual

Remote command:

`[:SOURCE<hw>] :BB:EUTRa:DL [:SUBF<st0>] :ALLoc<ch0> [:CW<user>] :DATA`
on page 609

`[:SOURCE<hw>] :BB:EUTRa:DL [:SUBF<st0>] :ALLoc<ch0> [:CW<user>] :`
DSElect on page 610

`[:SOURCE<hw>] :BB:EUTRa:DL [:SUBF<st0>] :ALLoc<ch0> [:CW<user>] :`
PATTern on page 610

Rho A

Sets the power P_{PDSCH} (ρ A) respectively P_{PBCH} for the selected allocation.

The power of the PDCCH allocation P_{PDCCH} is read-only. The value is set in the "Enhanced Channel Configuration" dialog of the corresponding subframe.

Remote command:

`[:SOURCE<hw>] :BB:EUTRa:DL [:SUBF<st0>] :ALLoc<ch0> [:CW<user>] :`
POWER on page 611

Content Type

Indicates the type of the selected allocation.

Note: There can be only one PBCH in subframe 0.

Remote command:

`[:SOURCE<hw>] :BB:EUTRa:DL [:SUBF<st0>] :ALLoc<ch0> [:CW<user>] :`
CONTType? on page 611

State

Sets the allocation to active or inactive state.

In case two codewords are configured, the state of the allocation with the second codeword is determinate by the state of the first one.

Remote command:

`[:SOURCE<hw>] :BB:EUTRa:DL [:SUBF<st0>] :ALLoc<ch0> [:CW<user>] :`
STATE on page 612

Conflict

Indicates a conflict between allocations.

For more information, see [Chapter A, "Conflict handling"](#), on page 943.

Remote command:

`[:SOURce<hw>] :BB:EUTRa:DL [:SUBF<st0>] :ALLoc<ch0> [:CW<user>] : CONFLICT` on page 612

4.3.11 PCFICH settings

Access:

1. Select "General > Link Direction > Downlink (OFDMA)".
2. Select "Frame Configuration > PCFICH".

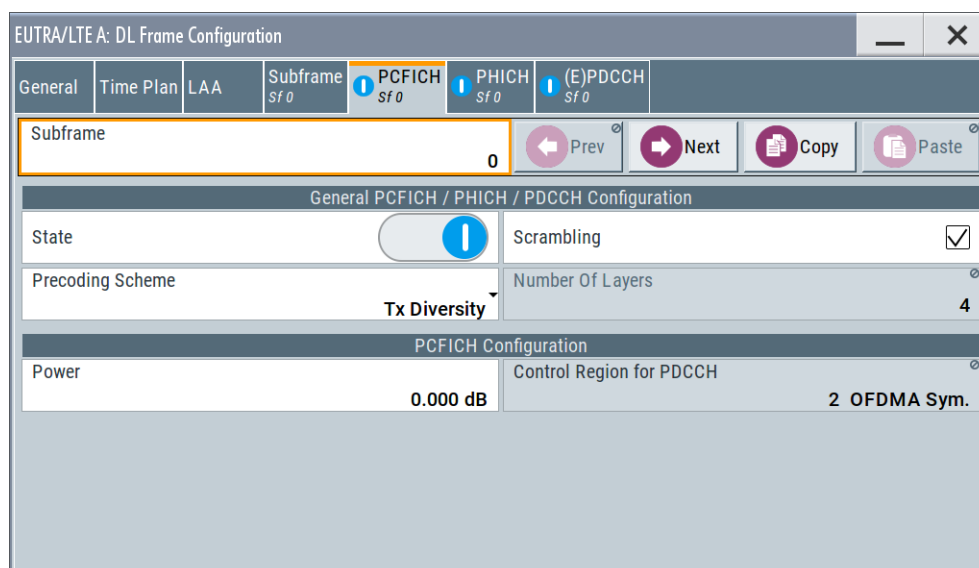

This dialog comprises the settings required for configuring PCFICH.

Settings:

[General PCFICH/PHICH/PDCCH Configuration](#)..... 171

- [L State](#)..... 172
- [L Precoding Scheme](#)..... 172
- [L Number of Layers \(Enhanced Channels\)](#)..... 172
- [L Scrambling State](#)..... 172

[PCFICH Configuration](#)..... 172

- [L PCFICH Power](#)..... 172
- [L Control Region for PDCCH \(PCell\)](#)..... 172

General PCFICH/PHICH/PDCCH Configuration

Comprises the settings common to all DL enhanced channels.

State ← General PCFICH/PHICH/PDCCH Configuration

Enables/disables the PDCCH, PCFICH and PHICH allocation.

Remote command:

`[:SOURCE<hw>] :BB:EUTRa:DL [:SUBF<st0>] :ENCC:STATE` on page 658

Precoding Scheme ← General PCFICH/PHICH/PDCCH Configuration

Selects the precoding scheme for PDCCH, PCFICH and PHICH.

"None" Disables precoding.

"Tx Diversity" Precoding for transmit diversity is performed according to [TS 36.211](#) and the selected parameters.

Remote command:

`[:SOURCE<hw>] :BB:EUTRa:DL [:SUBF<st0>] :ENCC:PRECoding:SCHEME`
on page 659

Number of Layers (Enhanced Channels) ← General PCFICH/PHICH/PDCCH Configuration

(Enabled for [Precoding Scheme](#) set to Tx Diversity)

Displays the number of layers for PDCCH, PCFICH and PHICH. This value is fixed to 1 for PDCCH, PCFICH and PHICH.

Remote command:

`[:SOURCE<hw>] :BB:EUTRa:DL [:SUBF<st0>] :ENCC:PRECoding:NOLayers?`
on page 659

Scrambling State ← General PCFICH/PHICH/PDCCH Configuration

Enables/disables the scrambling of all DL enhanced channels.

Remote command:

`[:SOURCE<hw>] :BB:EUTRa:DL [:SUBF<st0>] :ENCC:SCRambling:STATE`
on page 658

PCFICH Configuration

Comprises the PCFICH settings:

PCFICH Power ← PCFICH Configuration

Sets the power of the PCFICH (P_{PCFICH}).

Remote command:

`[:SOURCE<hw>] :BB:EUTRa:DL [:SUBF<st0>] :ENCC:PCFich:POWER`
on page 659

Control Region for PDCCH (PCell) ← PCFICH Configuration

Sets the size of the control region, i.e. the number of OFDM Symbols that the region spans (see [Table 4-5](#)).

Table 4-5: Number of OFDM symbols in the control region for PDCCH

Channel Bandwidth	PHICH Duration	Duplex. Mode	OFDM Symbols in	The control region
			Normal Subframe	Special Subframe
No RB > 10	Normal	FDD	1, 2, 3	-
	Normal	TDD	1, 2, 3	1, 2
	Extended	FDD	3	-
	Extended	TDD	3	2
No RB <=10	Normal	FDD	2, 3, 4	-
	Normal	TDD	2, 3, 4	2
	Extended	FDD	3, 4	-
	Extended	TDD	3, 4	2

The size of the control region can vary per subframe.

Remote command:

[:SOURCE<hw>] :BB:EUTRa:DL [:SUBF<st0>] :ENCC:PCFich:CREGion

on page 660

4.3.12 PHICH settings

Access:

1. Select "General > Link Direction > Downlink (OFDMA)".
2. Select "Frame Configuration > PHICH".

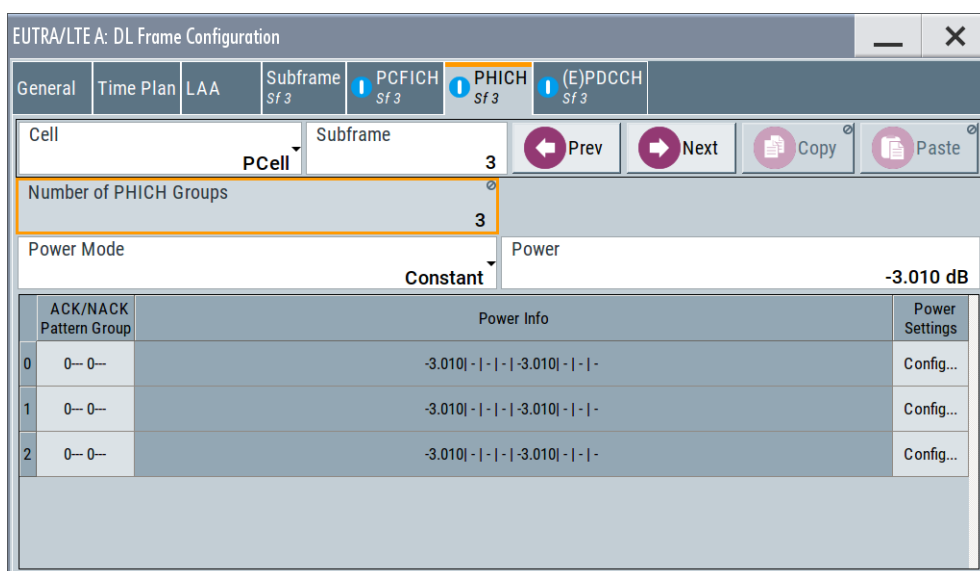

This dialog comprises the settings required for configuring PHICH.

Provided are the following settings:

Cell.....	174
Number of PHICH Groups.....	174
Power Mode.....	174
PHICH Power.....	175
PHICHs Table.....	175
L ACK/NACK Pattern Group x.....	175
L Power Info.....	175
L Power Settings Config.....	175

Cell

With enabled "General DL Settings > CA > Activate Carrier Aggregation > On" state, indicates to which cell (i.e. component carrier) the settings apply.

Remote command:

n.a

Number of PHICH Groups

Displays the number of available PHICH groups, depending on the value of the parameter [PHICH N_g](#).

If "PHICH N_g > Custom", this parameter is enabled for configuration.

- For normal CP, one PHICH group consists of 8 ACK/NACK messages from several users.
- For extended CP, one PHICH group carries 4 ACK/NACK messages from several users.

Each PHICH group uses 3 resource element groups (REGs); hence the total number of REGs used for PHICH is 3 times the number of PHICH groups.

The number of the available OFDM symbols for the allocation of this total number of REGs depends on the selection made for the parameter [PHICH Duration](#) (normal or extended).

Remote command:

`[:SOURCE<hw>] :BB:EUTRa:DL [:SUBF<st0>] :ENCC:PHICH [:CELL<ccid>] :NOGRoups` on page 661

Power Mode

Determines whether all PHICHs in a PHICH group are sent with the same power or enables the adjustment of each P_{PHICH} individually.

The parameter [Power Info](#) displays the power values of the configured PHICHs.

"Constant" The power of a PHICH (P_{PHICH}) in a PHICH group is set with the parameter [Power](#).

"Individual" The power of the individual PHICHs is set in the [PHICH Power Config](#) dialog.

Remote command:

`[:SOURCE<hw>] :BB:EUTRa:DL [:SUBF<st0>] :ENCC:PHICH:PMODE` on page 660

PHICH Power

Sets the power of one PHICH (P_{PHICH}) in a PHICH group, i.e. the total power of one PHICH group is the sum of the power of the transmitted PHICHs within this group.

Remote command:

`[:SOURCE<hw>] :BB:EUTRa:DL [:SUBF<st0>] :ENCC:PHICH:POWer` on page 661

PHICHs Table

Comprises the settings of the PHICHs.

ACK/NACK Pattern Group x ← PHICHs Table

Sets the ACK/NACK pattern for the corresponding PHICH group, where:

- "1" indicates an ACK
- "0" indicates a NACK
- "-" indicates DTX
DTX means that the corresponding PHICH is not transmitted, i.e. the orthogonal sequence is not used.

The number of ACK/NACK messages carried by a PHICH group depends on the [Cyclic Prefix](#). Hence, a pattern group consists of 8 or 4 values for normal and extended CP respectively.

Remote command:

`[:SOURCE<hw>] :BB:EUTRa:DL [:SUBF<st0>] :ENCC:PHICH:CELL<ch0> : ANPattern<gr0>` on page 661

Power Info ← PHICHs Table

Displays the power values of the configured PHICHs.

Remote command:

n.a.

Power Settings Config. ← PHICHs Table

Opens the "PHICH Power Config". dialog to configure the power of the PHICHs individual.

EUTRA/LTE A: PHICH Group Power Conf.	
PHICH 0 -3.010 dB	PHICH 1 -3.010 dB
PHICH 2 -3.010 dB	PHICH 3 -3.010 dB
PHICH 4 -3.010 dB	PHICH 5 -3.010 dB
PHICH 6 -3.010 dB	PHICH 7 -3.010 dB
PCell / Subframe 0	
ACK/NACK Pattern Group 0	

"ACK/NACK Pattern Group"

Displays the ACK/NACK pattern group the values are adjusted for.

"PHICH x"

Sets the power of the individual PHICHs.

Remote command:

```
[ :SOURCE<hw> ] :BB:EUTRa:DL [ :SUBF<st0> ] :ENCC:PHICH [ :CELL<ccidx> ] :
GRoup<gr0> :ITEM<user0> :POW on page 662
```

4.3.13 (E)PDCCH settings

Access:

1. Select "General > Link Direction > Downlink (OFDMA)".
2. Select "Frame Configuration > (E)PDCCH".

3. Select "PDCCH Format = 1".

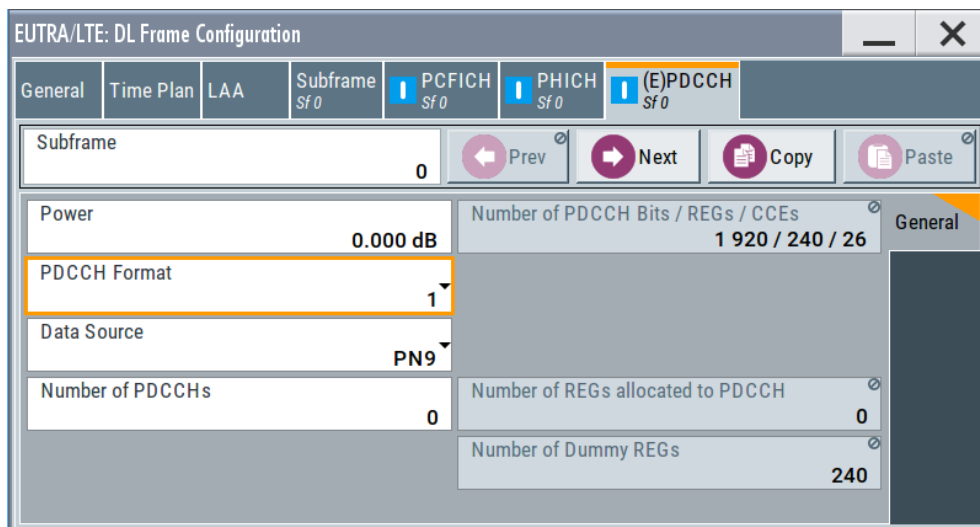

This dialog comprises the settings required for configuring PDCCH.

Settings:

PDCCH Format..... 177
 Power..... 178
 Number of PDCCH Bits / REGs / CCEs..... 178
 Number of PDCCHs..... 179
 Number of REGs allocated to PDCCH..... 179
 Number of Dummy REGs..... 180
 Data Source..... 180

PDCCH Format

Sets the PDCCH format.

The PDCCH format determines how many CCEs (control channel elements) are used for the transmission of the PDCCH, i.e. determines how many PDCCHs (#PDCCH) can be transmitted.

The following figure shows the distribution of the PDCCH over the CCEs for the different formats.

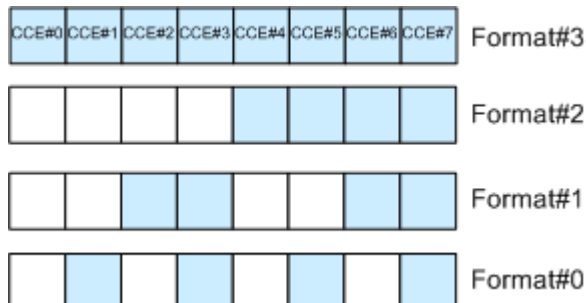

"Variable"	Select this mode to enable full flexibility by the configuration of the downlink control information (DCI) format and content (see Chapter 4.3.14, "(E)PDCCH format variable" , on page 180).
"-1"	Proprietary format for legacy support. This format corresponds to the transmission of one PDCCH on all available REGs, i.e. <ul style="list-style-type: none"> • Number of available REGs = #REGs allocated PDCCH, • #PDCCH = 1, • #DummyREGs = 0.
"0"	One PDCCH is transmitted on one CCE, i.e. #REG=1 .
"1"	One PDCCH is transmitted on two CCEs, i.e. #REG=18 .
"2"	One PDCCH is transmitted on four CCEs, i.e. #REG=36 .
"3"	One PDCCH is transmitted on eight CCEs, i.e. #REG=72 .

Remote command:

[\[:SOURCE<hw>\]:BB:EUTRa:DL\[:SUBF<st0>\]:ENCC:PDCCh:FORMAT](#)
on page 664

Power

Sets the power of the PDCCH (P_{PDCCH}).

The value set with this parameter is also displayed in the allocation table for the corresponding allocation.

Remote command:

[\[:SOURCE<hw>\]:BB:EUTRa:DL\[:SUBF<st0>\]:ENCC:PDCCh:POWer](#) on page 662

Number of PDCCH Bits / REGs / CCEs

Displays the number of bits / REGs / CCEs allocated for PDCCH.

"Number of PDCCH Bits"

Indicates the number of bits available for PDCCH.

The number of bits available for PDCCH allocation depends on the selected:

- [Channel Bandwidth](#)
- [Global MIMO Configuration](#)
[Number of PHICH Groups](#)
- [PHICH Duration](#)
- [Control Region for PDCCH \(PCell\)](#)

Remote command:

[\[:SOURCE<hw>\]:BB:EUTRa:DL\[:SUBF<st0>\]:ENCC:PDCCh:BITS](#) on page 663

"Number of PDCCH REGs"

Indicates the number of the REGs that are available for the PDCCH allocation.

The number of REGs available for PDCCH allocation depends on the "Number of PDCCH Bits" (#Bits_{PDCCH}) and is calculated as follows:

$$\#REGs\ available_{PDCCH} = \#Bits_{PDCCH} / 8$$

Remote command:

[:SOURCE<hw>] :BB:EUTRa:DL [:SUBF<st0>] :ENCC:PDCCh:BITS on page 663

"Number of PDCCH CCEs"

Indicates the number of the control channel elements (CCEs) that are available for the PDCCH allocation.

The PDCCH is mapped to the REGs not used for PHICH and PCFICH and transmitted on one or several CCEs, where a CCE corresponds to 9 REGs, i.e. the number of the available CCEs is calculated as follows:

$$\#CCEs\ available_{PDCCH} = \text{"Number of PDCCH REGs"} / 9$$

Note: If **Activate Carrier Aggregation** > "On", the parameter "Number of available CCEs" displays information about the PCell.

Information related to the SCells is displayed by the corresponding parameter **No. Dummy (E)CCEs**.

Remote command:

[:SOURCE<hw>] :BB:EUTRa:DL [:SUBF<st0>] :ENCC:PDCCh:AVCCes on page 663

Number of PDCCHs

(for "PDCCH Format" different than "Variable")

Sets the number of PDCCHs to be transmitted.

The maximum number PDCCH that can be transmitted on the available REGs for PDCCH depends on the number of REGs (#REG) reserved for the transmission of one PDCCH, i.e. depends on the selected **PDCCH Format** and is calculated as follows:

$$\#PDCCH = \text{Number of PDCCH REGs} / \#REG.$$

Remote command:

[:SOURCE<hw>] :BB:EUTRa:DL [:SUBF<st0>] :ENCC:PDCCh:NOPDcchs on page 664

Number of REGs allocated to PDCCH

(for "PDCCH Format" different than "Variable")

Defines the number of REGs that are allocated for PDCCH transmission (#REGs allocated_{PDCCH}) and is calculated as follows:

$$\#REGs\ allocated_{PDCCH} = \#PDCCH * \#REG$$

Remote command:

[:SOURCE<hw>] :BB:EUTRa:DL [:SUBF<st0>] :ENCC:PDCCh:ALRegs on page 665

Number of Dummy REGs

(for "PDCCH Format" different than "Variable")

Displays the number of REGs that are available for the PDCCH allocation but are not allocated and is calculated as follows:

#DummyREGs = **Number of PDCCH REGs** - #REGs allocated PDCCH.

Remote command:

[:SOURce<hw>] :BB:EUTRa:DL [:SUBF<st0>] :ENCC:PDCCh:DREGs on page 665

Data Source

(for "PDCCH Format" different than "Variable")

Selects the data source for PDCCH.

The following standard data sources are available:

- "All 0, All 1"
An internally generated sequence containing 0 data or 1 data.
- "PNxx"
An internally generated pseudo-random noise sequence.
- "Pattern"
An internally generated sequence according to a bit pattern.
Use the "Pattern" box to define the bit pattern.
- "Data List/Select DList"
A binary data from a data list, internally or externally generated.
Select "Select DList" to access the standard "Select List" dialog.
 - Select the "Select Data List > navigate to the list file *.dm_iqd > Select" to select an existing data list.
 - Use the "New" and "Edit" functions to create internally new data list or to edit an existing one.
 - Use the standard "File Manager" function to transfer external data lists to the instrument.

See also:

- Section "Modulation Data" in the R&S SMM100A user manual.
- Section "File and Data Management" in the R&S SMM100A user manual.
- Section "Data List Editor" in the R&S SMM100A user manual

Remote command:

[:SOURce<hw>] :BB:EUTRa:DL [:SUBF<st0>] :ENCC:PDCCh:DATA on page 665

[:SOURce<hw>] :BB:EUTRa:DL [:SUBF<st0>] :ENCC:PDCCh:PATtern

on page 666

[:SOURce<hw>] :BB:EUTRa:DL [:SUBF<st0>] :ENCC:PDCCh:PATtern

on page 666

4.3.14 (E)PDCCH format variable

Access:

1. Select "General > Link Direction > Downlink (OFDMA)".
2. Select "Frame Configuration > (E)PDCCH".

3. Select **PDCCH Format** > "Variable".

Use these parameters and the DCI table to configure the multiple scheduling messages (DCIs) with the corresponding (E)PDCCHs.

Dummy CCE REGs.....	181
Dummy CCE Data Source.....	182
Standard configuration functions.....	182
Reset.....	183
Resolve Conflicts.....	183
DCI Table.....	183
L Number of Used (E)PDCCH Items.....	184
L User.....	184
L UE_ID/n_RNTI.....	185
L Cell Index.....	185
L Carrier Indicator Field (CIF).....	185
L (E)PDCCH.....	186
L DCI Format.....	186
L Search Space.....	187
L Content Config/ Content Act./Rel.....	188
L (E)PDCCH Format (Variable).....	188
L Number (E)CCEs.....	189
L (E)CCE Index.....	189
L No. Dummy (E)CCEs.....	189
L Conflict (DCI).....	189

Dummy CCE REGs

Sets the behavior of the dummy REGs, i.e. determines whether dummy data or DTX is transmitted.

Remote command:

```
[ :SOURce<hw> ] :BB:EUTRa:DL [ :SUBF<st0> ] :ENCC:PDCCh:DCRegs:TRSource  
on page 666
```

Dummy CCE Data Source

Selects the data source for the dummy CCE.

The following standard data sources are available:

- "All 0, All 1"
An internally generated sequence containing 0 data or 1 data.
- "PNxx"
An internally generated pseudo-random noise sequence.
- "Pattern"
An internally generated sequence according to a bit pattern.
Use the "Pattern" box to define the bit pattern.
- "Data List/Select DList"
A binary data from a data list, internally or externally generated.
Select "Select DList" to access the standard "Select List" dialog.
 - Select the "Select Data List > navigate to the list file *.dm_iqd > Select" to select an existing data list.
 - Use the "New" and "Edit" functions to create internally new data list or to edit an existing one.
 - Use the standard "File Manager" function to transfer external data lists to the instrument.

See also:

- Section "Modulation Data" in the R&S SMM100A user manual.
- Section "File and Data Management" in the R&S SMM100A user manual.
- Section "Data List Editor" in the R&S SMM100A user manual

Remote command:

`[:SOURce<hw>] :BB:EUTRa:DL [:SUBF<st0>] :ENCC:PDCCh:DCRegs:DATA`
on page 667

`[:SOURce<hw>] :BB:EUTRa:DL [:SUBF<st0>] :ENCC:PDCCh:DCRegs:PATtern`
on page 667

`[:SOURce<hw>] :BB:EUTRa:DL [:SUBF<st0>] :ENCC:PDCCh:DCRegs:DSElect`
on page 667

Standard configuration functions

Standard configuration functions:

"Append" Adds a row at the end of the table.

Remote command:

`[:SOURce<hw>] :BB:EUTRa:DL [:SUBF<st0>] :ENCC:PDCCh:EXTC:APPend` on page 668

"Insert" Insert a new row before the current one.

Remote command:

`[:SOURce<hw>] :BB:EUTRa:DL [:SUBF<st0>] :ENCC:PDCCh:EXTC:SITem` on page 668

`[:SOURce<hw>] :BB:EUTRa:DL [:SUBF<st0>] :ENCC:PDCCh:EXTC:INSert` on page 668

"Delete"	<p>Deletes the selected row.</p> <p>Remote command: <code>[:SOURce<hw>] :BB:EUTRa:DL [:SUBF<st0>] :ENCC:PDCCh:EXTC:DELeTe</code> on page 668</p>
"Down/Up"	<p>Moves the selected row down or up.</p> <p>Remote command: <code>[:SOURce<hw>] :BB:EUTRa:DL [:SUBF<st0>] :ENCC:PDCCh:EXTC:DOWN</code> on page 669 <code>[:SOURce<hw>] :BB:EUTRa:DL [:SUBF<st0>] :ENCC:PDCCh:EXTC:UP</code> on page 669</p>

Reset

Resets the table.

Remote command:

`[:SOURce<hw>] :BB:EUTRa:DL [:SUBF<st0>] :ENCC:PDCCh:EXTC:RESet`
on page 670

Resolve Conflicts

The "Resolve Conf." is a built-in algorithm that reassigns automatically the CCE values depending on the configured "Search Space"; previously configured CCE values are not maintained. If the conflict cannot be resolved automatically, the values are left unchanged.

For more information on how to solve DCI conflicts, see [Chapter A.3, "DCI conflict handling"](#), on page 945.

Remote command:

`[:SOURce<hw>] :BB:EUTRa:DL [:SUBF<st0>] :ENCC:PDCCh:EXTC:SOLVe?`
on page 670

To query the number of current conflicts:

`[:SOURce<hw>] :BB:EUTRa:DL [:SUBF<st0>] :ENCC:PDCCh:EXTC:CONFlicts?`
on page 669

DCI Table

Access:

- Select "General > Link Direction > Downlink (OFDMA)".
- Select "Frame Configuration > (E)PDCCH".
- Select [PDCCH Format](#) > "Variable".
- Select "DCI Table".

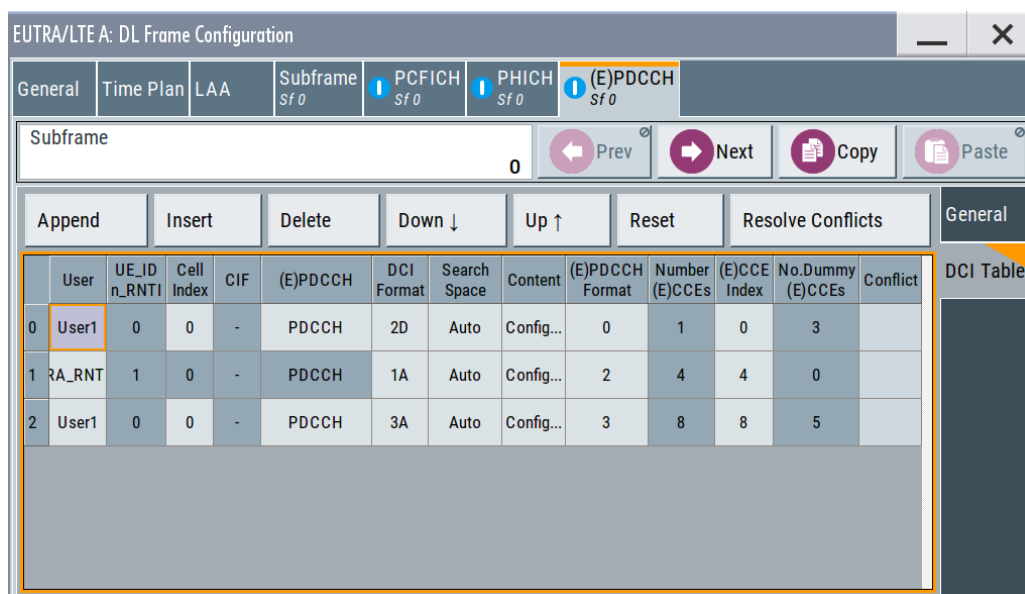

The "DCI Table" comprises the settings concerning the (E)PDCCH content.

Number of Used (E)PDCCH Items ← DCI Table

Displays the number of the (E)PDCCH items, i.e. the number of rows in the DCI table.

Remote command:

```
[ :SOURCE<hw> ] :BB:EUTRa:DL [ :SUBF<st0> ] :ENCC:PDCCh:EXTC:UITems
on page 670
```

User ← DCI Table

Selects the user the DCI is dedicated to. The available [DCI Format](#) depend on the value of this parameter.

Note: If [Activate Carrier Aggregation](#) > "On", the [Cell Index](#) determines the component carrier the corresponding user is mapped to.

To enable one particular user in more than one component carrier, append several table rows and enable the same "User" in the different component carriers.

"User x" Selects one of the four users configured in the [User configuration settings](#) dialog.

The DCIs of an inactive user ("Configure User" > [State](#) > "Off") are not configurable and not considered by the calculation of "No. Dummy CCEs".

"P-RNTI/S-RNTI/RA-RNTI"

A group of users is selected.

"User x eIMTA"

Option: R&S SMM-K113

Indicates that the user supports eIMTA. Use the DCI format 1C settings to define the UL/DL configuration numbers.

See "[DCI Format 1C for eIMTA](#)" on page 196.

- "CC-RNTI" Option: R&S SMM-K119
Sets that the DCI format 1C uses CRC scrambled with the CC-RNTI. Use the DCI format 1C settings to define the LAA subframe configuration. See "[DCI Format 1C for LAA](#)" on page 197.
- "User x SPS" Indicates an activated semi-persistent scheduling (SPS) for the corresponding user.
- "None" Allows free definition of all settings

Remote command:

[:SOURCE<hw>] :BB:EUTRa:DL [:SUBF<st0>] :ENCC:PDCCh:EXTC:ITEM<ch0> :
USER on page 674

UE_ID/n_RNTI ← DCI Table

Displays the UE_ID or the n_RNTI for the selected PDCCH.

Remote command:

[:SOURCE<hw>] :BB:EUTRa:DL [:SUBF<st0>] :ENCC:PDCCh:EXTC:ITEM<ch0> :
UEID on page 671

Cell Index ← DCI Table

Sets the component carrier on that the corresponding DCI is transmitted.

This parameter refers to the "DL Carrier Aggregation Configuration" > [Cell Index](#). The "Cell Index" of the PCell (primary cell) is always set to 0.

Example:

If the following settings are enabled in the "DL Carrier Aggregation Configuration" dialog, the value range of the parameter "Cell Index" is 0, 1, 3, 5 and 7.

Component carrier	Cell index
PCell	0
SCell#1	1
SCell#2	3
SCell#3	7
SCell#4	5

Remote command:

[:SOURCE<hw>] :BB:EUTRa:DL [:SUBF<st0>] :ENCC:PDCCh:EXTC:ITEM<ch0> :
CELL on page 672

Carrier Indicator Field (CIF) ← DCI Table

(Requires R&S SMM-K85)

This field is enabled if:

- [Activate Carrier Aggregation](#) > "On" and
- For each User with "Configure User" > [Activate CA](#).

The CIF is present in **each** DCI Format and identifies the component carrier that carries the PDSCH or PUSCH for the particular PDCCH in the cross-carrier approach (see [Figure 2-27](#)).

According to the LTE specification, cross-carrier scheduling is enabled by higher-level signaling. To simulate a cross-carrier scheduling in this implementation, enable the "[DL carrier aggregation configuration>CIF Present](#)" per each component carrier/cell.

Remote command:

```
[ :SOURce<hw> ] :BB:EUTRa:DL [ :SUBF<st0> ] :ENCC:PDCCh:EXTC:ITEM<ch0> :
DCIConf:CIField on page 676
```

(E)PDCCH ← DCI Table

Indicates if the DCI is carried by a PDCCH or by an EPDCCH set.

You can assign an EPDCCH set in the following cases:

- If the EPDCCH transmission and the particular set are activated for the selected user.
See [Chapter 4.3.5, "EPDCCH configuration settings"](#), on page 147.
- EPDCCH is not allocated in a TDD special subframe in one of the situations listed in [Table 4-6](#).

Table 4-6: Combinations of cyclic prefix and TDD special subframe configurations

"Cyclic Prefix"	TDD Special Subframe Config
Normal / Extended	0
Normal	5
Extended	4, 7, 8, 9

Remote command:

```
[ :SOURce<hw> ] :BB:EUTRa:DL [ :SUBF<st0> ] :ENCC:PDCCh:EXTC:ITEM<ch0> :
PDCChType on page 673
```

DCI Format ← DCI Table

Sets the DCI format for the selected PDCCH.

The downlink control information (DCI) is a message used to control the physical layer resource allocation in both the UL and DL direction. It carries scheduling information as well as uplink power control commands.

The DCI is mapped on the PDCCH and depending on the DCI message size and usage are categorized into four different formats that are further subdivided (see [Table 4-7](#)).

Table 4-7: Overview DCI formats

DCI format	Purpose
DCI Format 0	PUSCH allocation information
DCI Format 1 DCI Format 1A DCI Format 1B DCI Format 1C DCI Format 1D	PDSCH information with one codeword

DCI format	Purpose
DCI Format 2/2A/2B/2C/2D	PDSCH information for MIMO configuration (two codewords)
DCI Format 3/3A	Uplink power control information

The fields of each DCI format are configurable parameters that can be adjusted in the corresponding dialog box. Select [Content Config/ Content Act./Rel.](#) to access this dialog box for the selected "DCI Format".

Not all DCI formats are always enabled for selection.

The following table gives an overview of the cross-reference between the available DCI formats and the value of the parameter [User](#).

User	DCI format
P-RNTI/SI-RNTI/RA-RNTI	1A, 1C
User x	1, 1A, 1B, 1D, 2, 2A, 2B, 2C, 2D
None	All formats

See also [TS 36.212](#), chapter 5.3.3.1.

Remote command:

```
[ :SOURCE<hw> ] :BB:EUTRa:DL [ :SUBF<st0> ] :ENCC:PDCCh:EXTC:ITEM<ch0> :DCIFmt
```

on page 671

Search Space ← DCI Table

Defines the search space for the selected DCI, i.e. determines the valid CCE indexes.

The search space determines the set of CCEs a UE monitors. The UE can decode only the control information on a PDCCH that is transmitted over CCEs within the search space this UE monitors.

Note: The 3GPP specification defines two kinds of search spaces, the common and the UE-specific search space.

Avoid the use of the "Auto" and "Off" values; these values are provided for backwards compatibility reasons only.

"Off"	No search space is determined. All CCEs are monitored.
"Auto"	Provided for backward compatibility only. An internal mapping to the common and UE-specific search space is applied depending on the value of the parameter "User": <ul style="list-style-type: none"> • For "User x", "Auto" corresponds to "UE-spec" • In all other cases, "Auto" corresponds to "Common"
"Common"	The DCI is mapped to the common search space. A common search space is used when all or a group of UEs is addressed. The combination "User 1" and common search space is enabled in PCell only.

"UE-spec" Non-common DCIs are mapped to the UE-specific search space. Each UE has multiple UE-specific search space, determined as a function of the UE_ID and the subframe. A UE-specific search space applies for the [User](#) set to "User x".

Remote command:

[:SOURCE<hw>] :BB:EUTRa:DL [:SUBF<st0>] :ENCC:PDCCh:EXTC:ITEM<ch0> :SESPace on page 674

Content Config/ Content Act./Rel. ← DCI Table

Opens the [DCI format configuration](#) dialog to configure the DCI fields of the selected [DCI Format](#).

In the activation and release subframes of users that are semi-persistent scheduled ([User](#) > "User x SPS"), the function "Act./Rel." accesses the [DCI format configuration](#) dialog to configure the special fields for the SPS validation.

Remote command:

n.a.

(E)PDCCH Format (Variable) ← DCI Table

Sets the (E)PDCCH format.

The (E)PDCCH format determines how many (E)CCEs are used for the transmission of the (E)PDCCH.

Table 4-8: Supported PDCCH formats [TS 36.211]

PDCCH format	Number of CCEs	Number of REGs	Number of PDCCH bits
0	1	9	72
1	2	18	144
2	4	36	288
3	8	72	576

Table 4-9: EPDCCH formats and number of ECCEs for one EPDCCH N^{EPDCCH}_{ECCE} [TS 36.211]

EPDCCH format	Case A	Case B
0	2	1
1	4	2
2	8	4
3	16	8
4	- / 32*	- / 16*

*) EPDCCH format 4 is supported if distributed transmission is used (see [Transmission Type](#)).

Remote command:

[:SOURCE<hw>] :BB:EUTRa:DL [:SUBF<st0>] :ENCC:PDCCh:EXTC:ITEM<ch0> :PFMT on page 672

Number (E)CCEs ← DCI Table

Defines the number of control channel elements used for the transmission of the (E)PDCCH.

The value depends on the selected [\(E\)PDCCH format](#).

Remote command:

`[:SOURCE<hw>] :BB:EUTRa:DL [:SUBF<st0>] :ENCC:PDCCh:EXTC:ITEM<ch0> :NCCes?` on page 672

(E)CCE Index ← DCI Table

Sets the (E)CCE start index.

The available ECCEs depend on the selected [\(E\)PDCCH format](#).

Remote command:

`[:SOURCE<hw>] :BB:EUTRa:DL [:SUBF<st0>] :ENCC:PDCCh:EXTC:ITEM<ch0> :CINDEX` on page 673

No. Dummy (E)CCEs ← DCI Table

Defines the number of dummy (E)CCEs that are appended to the corresponding PDCCH.

Note: If [Activate Carrier Aggregation](#) > "On", the "Number of Dummy CCEs" is calculated per component carrier and depends on the selected [Bandwidth](#).

Remote command:

`[:SOURCE<hw>] :BB:EUTRa:DL [:SUBF<st0>] :ENCC:PDCCh:EXTC:ITEM<ch0> :NDCCes?` on page 673

Conflict (DCI) ← DCI Table

Indicates a conflict between two DCI formats.

For more information on how to solve DCI conflicts, see [Chapter A.3, "DCI conflict handling"](#), on page 945.

Remote command:

`[:SOURCE<hw>] :BB:EUTRa:DL [:SUBF<st0>] :ENCC:PDCCh:EXTC:ITEM<ch0> :CONFLICT?` on page 675
`[:SOURCE<hw>] :BB:EUTRa:DL [:SUBF<st0>] :ENCC:PDCCh:EXTC:CONFLICTs?` on page 669

4.3.15 DCI format configuration

For information on the provided settings, see also [TS 36.212](#), chapter 5.3.3.1.

Carrier Indicator Field (CIF)	190
Bit Data	190
DCI Format 0	190
DCI Format 1	191
DCI Format 1A	192
DCI Format 1B	194
DCI Format 1C	195
DCI Format 1C for eIMTA	196

DCI Format 1C for LAA..... 197
 DCI Format 1D..... 198
 DCI Format 2/2A/2B/2C/2D..... 199
 DCI Format 3/3A..... 201

Carrier Indicator Field (CIF)

(Requires R&S SMM-K85)

This field is enabled if:

- [Activate Carrier Aggregation](#) > "On" and
- For each User with "Configure User" > [Activate CA](#).

The CIF is present in **each** DCI Format and identifies the component carrier that carries the PDSCH or PUSCH for the particular PDCCH in the cross-carrier approach (see [Figure 2-27](#)).

According to the LTE specification, cross-carrier scheduling is enabled by higher-level signaling. To simulate a cross-carrier scheduling in this implementation, enable the "[DL carrier aggregation configuration>CIF Present](#)" per each component carrier/cell.

Remote command:

```
[ :SOURce<hw> ] :BB:EUTRa:DL [ :SUBF<st0> ] :ENCC:PDCCh:EXTC:ITEM<ch0> : DCIConf:CIField on page 676
```

Bit Data

Displays the resulting bit data as selected with the DCI format parameters.

Mapping of the information bits is according to [TS 36.212](#).

Remote command:

```
[ :SOURce<hw> ] :BB:EUTRa:DL [ :SUBF<st0> ] :ENCC:PDCCh:EXTC:ITEM<ch0> : DCIConf:BITData? on page 676
```

DCI Format 0

The DCI format 0 is used for scheduling uplink transmission on PUSCH and transmits the information listed in the following table.

DCI Format 0	
PUSCH Frequency Hopping	<input type="checkbox"/> Res.Block Assignment and Hop.Res.Allocation 0
Modulation and Cod. Scheme and Red.Version	0 New Data Indicator <input type="checkbox"/>
TPC Command for PUSCH	0 Cyclic Shift for DMRS 0
CSI/CQI Request	0
Resource Allocation Type	0

The fields defined in the DCI format are mapped to the information bits according to the 3GPP specification and the resulting [Bit Data](#) is displayed.

If the DCI format is used for validation of the semi-persistent scheduling (SPS) activation or release, some special DCI fields are predefined according to Tables 9.2 in TS 36.213. See also [Chapter 4.3.7, "SPS configuration settings"](#), on page 153.

Control Information Field	SCPI command	Dependencies
"Carrier Indicator Field (CIF)"	[:SOURCE<hw>]:BB:EUTRa:DL[:SUBF<st0>]:ENCC:PDCCh:EXTC:ITEM<ch0>:DCIConf:CIField on page 676	See " Carrier Indicator Field (CIF) " on page 185
"PUSCH Frequency Hopping"	[:SOURCE<hw>]:BB:EUTRa:DL[:SUBF<st0>]:ENCC:PDCCh:EXTC:ITEM<ch0>:DCIConf:PFHopping on page 682	
"Resource Block Assignment and Hopping Resource Allocation"	[:SOURCE<hw>]:BB:EUTRa:DL[:SUBF<st0>]:ENCC:PDCCh:EXTC:ITEM<ch0>:DCIConf:RAHR on page 683	
"Modulation and Coding Scheme and Redundancy Version"	[:SOURCE<hw>]:BB:EUTRa:DL[:SUBF<st0>]:ENCC:PDCCh:EXTC:ITEM<ch0>:DCIConf:MCSR on page 680	
"New Data Indicator"	[:SOURCE<hw>]:BB:EUTRa:DL[:SUBF<st0>]:ENCC:PDCCh:EXTC:ITEM<ch0>:DCIConf:NDI on page 681	
"TPC Command for PUSCH"	[:SOURCE<hw>]:BB:EUTRa:DL[:SUBF<st0>]:ENCC:PDCCh:EXTC:ITEM<ch0>:DCIConf:TPCC on page 687	
"Cyclic Shift for DMRS"	[:SOURCE<hw>]:BB:EUTRa:DL[:SUBF<st0>]:ENCC:PDCCh:EXTC:ITEM<ch0>:DCIConf:CSDMrs on page 678	
"UL Index"	[:SOURCE<hw>]:BB:EUTRa:DL[:SUBF<st0>]:ENCC:PDCCh:EXTC:ITEM<ch0>:DCIConf:ULIndex on page 688	TDD mode and TDD frame structure settings 0
"Downlink Assignment Index"	[:SOURCE<hw>]:BB:EUTRa:DL[:SUBF<st0>]:ENCC:PDCCh:EXTC:ITEM<ch0>:DCIConf:DLAindex on page 678	TDD mode and "UL/DL Configuration = 1 to 6"
"CSI/CQI Request"	[:SOURCE<hw>]:BB:EUTRa:DL[:SUBF<st0>]:ENCC:PDCCh:EXTC:ITEM<ch0>:DCIConf:CSIRequest on page 678	"Search Space" other than "Common" and "User > Tx Mode = TM10"
"SRS Request"	[:SOURCE<hw>]:BB:EUTRa:DL[:SUBF<st0>]:ENCC:PDCCh:EXTC:ITEM<ch0>:DCIConf:SRSRequest on page 684	"User Configuration" > Aperiodic SRS State > "On"
"Resource Allocation Type"	[:SOURCE<hw>]:BB:EUTRa:DL[:SUBF<st0>]:ENCC:PDCCh:EXTC:ITEM<ch0>:DCIConf:RAType on page 684	

DCI Format 1

The DCI format 1 carries information for scheduling transmission of one codeword on PDSCH. The different fields of this format are summarized in the following table.

DCI Format 1	
Resource Allocation Header	<input checked="" type="checkbox"/>
Resource Block Assignment	1
HARQ Process Number	0
Redundancy Version	0
Modulation and Coding Scheme	0
New Data Indicator	<input type="checkbox"/>
TPC Command for PUCCH	0

Bit Data: 100 0000 0000 0000 0010 0000 0000 0000

The fields defined in the DCI format are mapped to the information bits according to the 3GPP specification and the resulting **Bit Data** is displayed.

If the DCI format is used for validation of the semi-persistent scheduling (SPS) activation or release, some special DCI fields are predefined according to Tables 9.2 in TS 36.213. See also [Chapter 4.3.7, "SPS configuration settings"](#), on page 153.

Control Information Field	SCPI command	Dependencies
"Carrier Indicator Field (CIF)"	<code>[:SOURCE<hw>] :BB:EUTRa:DL[:SUBF<st0>] :ENCC: PDCCh:EXTC:ITEM<ch0> :DCIConf:CIField</code> on page 676	See " Carrier Indicator Field (CIF) " on page 185
"Resource Allocation Header"	<code>[:SOURCE<hw>] :BB:EUTRa:DL[:SUBF<st0>] :ENCC: PDCCh:EXTC:ITEM<ch0> :DCIConf:RAH</code> on page 683	"Channel Bandwidth > 10RBs"
"Resource Block Assignment"	<code>[:SOURCE<hw>] :BB:EUTRa:DL[:SUBF<st0>] :ENCC: PDCCh:EXTC:ITEM<ch0> :DCIConf:RBA</code> on page 684	
"Modulation and Coding Scheme"	<code>[:SOURCE<hw>] :BB:EUTRa:DL[:SUBF<st0>] :ENCC: PDCCh:EXTC:ITEM<ch0> :DCIConf:MCSR</code> on page 680	
"HARQ Process Number"	<code>[:SOURCE<hw>] :BB:EUTRa:DL[:SUBF<st0>] :ENCC: PDCCh:EXTC:ITEM<ch0> :DCIConf:HPN</code> on page 679	
"New Data Indicator"	<code>[:SOURCE<hw>] :BB:EUTRa:DL[:SUBF<st0>] :ENCC: PDCCh:EXTC:ITEM<ch0> :DCIConf:NDI</code> on page 681	
"Redundancy Version"	<code>[:SOURCE<hw>] :BB:EUTRa:DL[:SUBF<st0>] :ENCC: PDCCh:EXTC:ITEM<ch0> :DCIConf:RV</code> on page 684	
"TPC Command for PUCCH"	<code>[:SOURCE<hw>] :BB:EUTRa:DL[:SUBF<st0>] :ENCC: PDCCh:EXTC:ITEM<ch0> :DCIConf:TPCC</code> on page 687	
"Downlink Assignment Index"	<code>[:SOURCE<hw>] :BB:EUTRa:DL[:SUBF<st0>] :ENCC: PDCCh:EXTC:ITEM<ch0> :DCIConf:DLAindex</code> on page 678	TDD mode

DCI Format 1A

DCI format 1A is used for the compact scheduling of one PDSCH codeword and random access procedure initiated by a PDCCH order.

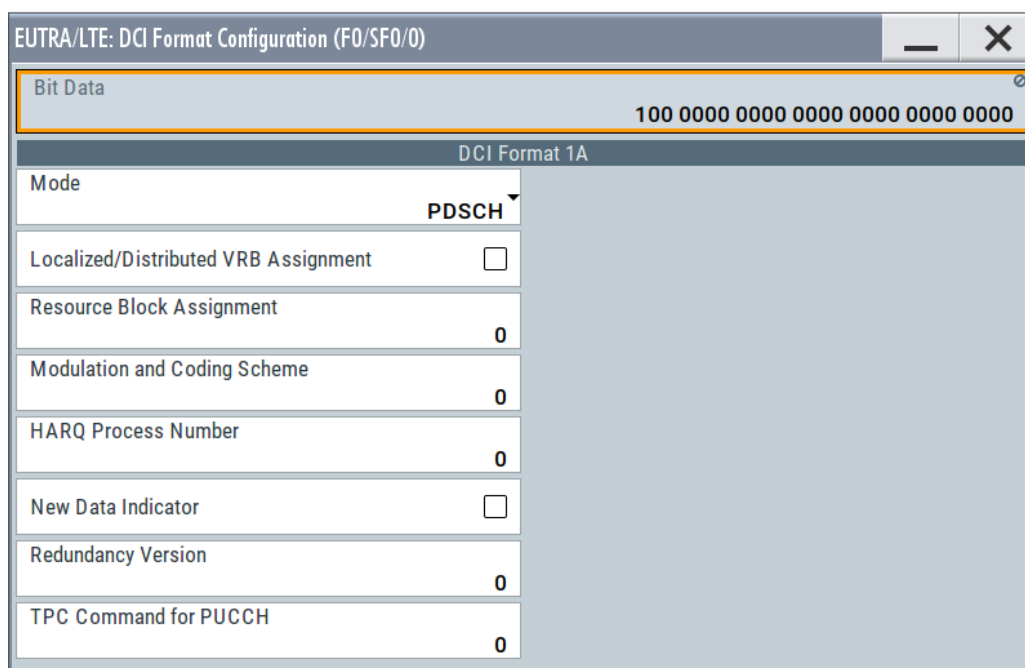

EUTRA/LTE: DCI Format Configuration (F0/SF0/0)

Bit Data: 100 0000 0000 0000 0000 0000 0000

DCI Format 1A

Mode: PDSCH

Localized/Distributed VRB Assignment:

Resource Block Assignment: 0

Modulation and Coding Scheme: 0

HARQ Process Number: 0

New Data Indicator:

Redundancy Version: 0

TPC Command for PUCCH: 0

The fields defined in the DCI format are mapped to the information bits according to the 3GPP specification and the resulting **Bit Data** is displayed.

The contents of DCI Format 1A are listed in the following table; the available fields depend whether a PDSCH or PRACH is transmitted.

If the DCI format is used for validation of the semi-persistent scheduling (SPS) activation or release, some special DCI fields are predefined according to Tables 9.2 in **TS 36.213**. See also **Chapter 4.3.7, "SPS configuration settings"**, on page 153.

Control Information Field	SCPI command	Dependencies
"Carrier Indicator Field (CIF)"	<code>[:SOURCE<hw>] :BB:EUTRa:DL[:SUBF<st0>] :ENCC: PDCCh:EXTC:ITEM<ch0>:DCIConf:CIField</code> on page 676	See "Carrier Indicator Field (CIF)" on page 185
"Mode"	<code>[:SOURCE<hw>] :BB:EUTRa:DL[:SUBF<st0>] :ENCC: PDCCh:EXTC:ITEM<ch0>:DCIConf:FlAMode</code> on page 676	
"Localized/Distributed VRB Assignment"	<code>[:SOURCE<hw>] :BB:EUTRa:DL[:SUBF<st0>] :ENCC: PDCCh:EXTC:ITEM<ch0>:DCIConf:VRBA</code> on page 689	
"GAP Value"	<code>[:SOURCE<hw>] :BB:EUTRa:DL[:SUBF<st0>] :ENCC: PDCCh:EXTC:ITEM<ch0>:DCIConf:GAP</code> on page 679	"Channel Bandwidth >= 50RBs", "Distributed VBR Assignment" and "User = User x"
"Resource Block Assignment"	<code>[:SOURCE<hw>] :BB:EUTRa:DL[:SUBF<st0>] :ENCC: PDCCh:EXTC:ITEM<ch0>:DCIConf:RBA</code> on page 684	
"Modulation and Coding Scheme"	<code>[:SOURCE<hw>] :BB:EUTRa:DL[:SUBF<st0>] :ENCC: PDCCh:EXTC:ITEM<ch0>:DCIConf:MCSR</code> on page 680	PDSCH Mode

Control Information Field	SCPI command	Dependencies
"HARQ Process Number"	[:SOURCE<hw>] :BB:EUTRa:DL[:SUBF<st0>] :ENCC: PDCCh:EXTC:ITEM<ch0> :DCIConf:HPN on page 679	PDSCH Mode
"New Data Indicator"	[:SOURCE<hw>] :BB:EUTRa:DL[:SUBF<st0>] :ENCC: PDCCh:EXTC:ITEM<ch0> :DCIConf:NDI on page 681	PDSCH Mode
"Redundancy Version"	[:SOURCE<hw>] :BB:EUTRa:DL[:SUBF<st0>] :ENCC: PDCCh:EXTC:ITEM<ch0> :DCIConf:RV on page 684	PDSCH Mode
"TPC Command for PUCCH"	[:SOURCE<hw>] :BB:EUTRa:DL[:SUBF<st0>] :ENCC: PDCCh:EXTC:ITEM<ch0> :DCIConf:TPCC on page 687	PDSCH Mode
"Downlink Assignment Index"	[:SOURCE<hw>] :BB:EUTRa:DL[:SUBF<st0>] :ENCC: PDCCh:EXTC:ITEM<ch0> :DCIConf:DLAindex on page 678	PDSCH Mode TDD mode
"SRS Request"	[:SOURCE<hw>] :BB:EUTRa:DL[:SUBF<st0>] :ENCC: PDCCh:EXTC:ITEM<ch0> :DCIConf:SRSRequest on page 684	"User Configuration > User x > Aperiodic SRS > On"
"Preamble Index"	[:SOURCE<hw>] :BB:EUTRa:DL[:SUBF<st0>] :ENCC: PDCCh:EXTC:ITEM<ch0> :DCIConf:PRACH:PRINDEX on page 677	PRACH Mode
"PRACH Mask Index"	[:SOURCE<hw>] :BB:EUTRa:DL[:SUBF<st0>] :ENCC: PDCCh:EXTC:ITEM<ch0> :DCIConf:PRACH:MINDEX on page 677	PRACH Mode

DCI Format 1B

DCI format 1B is used for the compact scheduling of one PDSCH codeword with precoding information, i.e. when MIMO operation is involved.

The precoding information consists of 2 or 4 bits for 2 and 4 antennas respectively.

DCI Format 1B	
Localized/Distributed VRB Assignment	<input type="checkbox"/>
Resource Block Assignment	0
Modulation and Coding Scheme	0
HARQ Process Number	0
New Data Indicator	<input type="checkbox"/>
Redundancy Version	0
TPC Command for PUCCH	0
TPMI Information for Precoding	0
PMI Confirmation for Precoding	<input type="checkbox"/>

The fields defined in the DCI format are mapped to the information bits according to the 3GPP specification and the resulting **Bit Data** is displayed.

The DCI Format 1B transmits the information listed in the following table.

Control Information Field	SCPI command	Dependencies
"Carrier Indicator Field (CIF)"	[:SOURCE<hw>] :BB:EUTRa:DL[:SUBF<st0>] :ENCC: PDCCh:EXTC:ITEM<ch0>:DCIConf:CIField on page 676	See "Carrier Indicator Field (CIF)" on page 185
"Localized/Distributed VRB Assignment"	[:SOURCE<hw>] :BB:EUTRa:DL[:SUBF<st0>] :ENCC: PDCCh:EXTC:ITEM<ch0>:DCIConf:VRBA on page 689	
"GAP Value"	[:SOURCE<hw>] :BB:EUTRa:DL[:SUBF<st0>] :ENCC: PDCCh:EXTC:ITEM<ch0>:DCIConf:GAP on page 679	"Channel Bandwidth >= 50RBs", "Distributed VBR Assignment" and "User = User x"
"Resource Block Assignment"	[:SOURCE<hw>] :BB:EUTRa:DL[:SUBF<st0>] :ENCC: PDCCh:EXTC:ITEM<ch0>:DCIConf:RBA on page 684	
"Modulation and Coding Scheme"	[:SOURCE<hw>] :BB:EUTRa:DL[:SUBF<st0>] :ENCC: PDCCh:EXTC:ITEM<ch0>:DCIConf:MCSR on page 680	
"HARQ Process Number"	[:SOURCE<hw>] :BB:EUTRa:DL[:SUBF<st0>] :ENCC: PDCCh:EXTC:ITEM<ch0>:DCIConf:HPN on page 679	
"New Data Indicator"	[:SOURCE<hw>] :BB:EUTRa:DL[:SUBF<st0>] :ENCC: PDCCh:EXTC:ITEM<ch0>:DCIConf:NDI on page 681	
"Redundancy Version"	[:SOURCE<hw>] :BB:EUTRa:DL[:SUBF<st0>] :ENCC: PDCCh:EXTC:ITEM<ch0>:DCIConf:RV on page 684	
"TPC Command for PUCCH"	[:SOURCE<hw>] :BB:EUTRa:DL[:SUBF<st0>] :ENCC: PDCCh:EXTC:ITEM<ch0>:DCIConf:TPCC on page 687	
"Downlink Assignment Index"	[:SOURCE<hw>] :BB:EUTRa:DL[:SUBF<st0>] :ENCC: PDCCh:EXTC:ITEM<ch0>:DCIConf:DLAindex on page 678	TDD mode
"TPMI Information for Precoding"	[:SOURCE<hw>] :BB:EUTRa:DL[:SUBF<st0>] :ENCC: PDCCh:EXTC:ITEM<ch0>:DCIConf:TPMI on page 687	
"PMI Confirmation for Precoding"	[:SOURCE<hw>] :BB:EUTRa:DL[:SUBF<st0>] :ENCC: PDCCh:EXTC:ITEM<ch0>:DCIConf:PMI on page 682	

DCI Format 1C

DCI format 1C is used for compact scheduling of one PDSCH codeword.

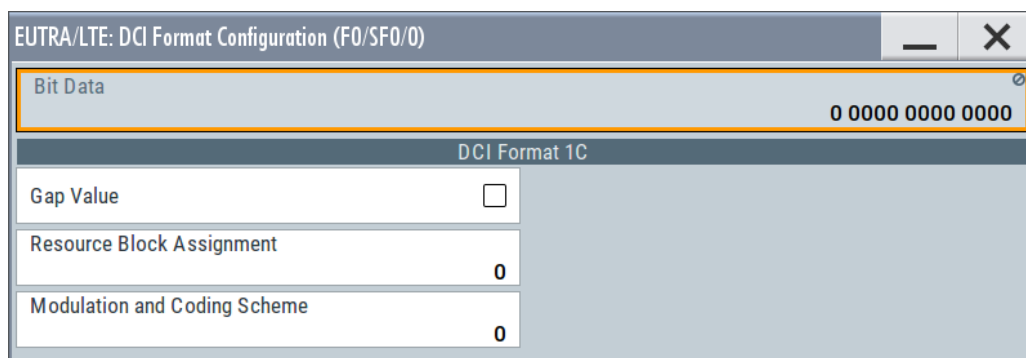

EUTRA/LTE: DCI Format Configuration (F0/SF0/0)

Bit Data: 0 0000 0000 0000

DCI Format 1C

Gap Value

Resource Block Assignment: 0

Modulation and Coding Scheme: 0

The fields defined in the DCI format are mapped to the information bits according to the 3GPP specification and the resulting **Bit Data** is displayed.

The DCI Format 1C transmits the information listed in the following table.

Control Information Field	SCPI command	Dependencies
GAP Value	[:SOURCE<hw>] :BB:EUTRa:DL[:SUBF<st0>] :ENCC: PDCCh:EXTC:ITEM<ch0> :DCIConf:GAP on page 679	[Channel Bandwidth >= 50 RBs]
Resource Block Assignment	[:SOURCE<hw>] :BB:EUTRa:DL[:SUBF<st0>] :ENCC: PDCCh:EXTC:ITEM<ch0> :DCIConf:RBA on page 684	
Modulation and Coding Scheme	[:SOURCE<hw>] :BB:EUTRa:DL[:SUBF<st0>] :ENCC: PDCCh:EXTC:ITEM<ch0> :DCIConf:MCSR on page 680	

DCI Format 1C for eIMTA

Option: R&S SMM-K113

To enable this parameter, select "DCI Table" > **User** > "User x eIMTA".

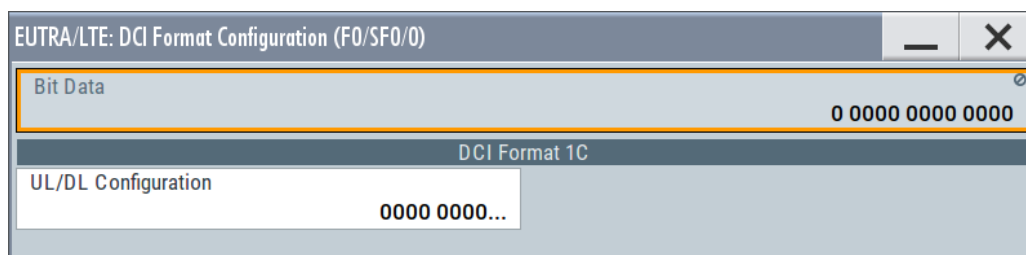

EUTRA/LTE: DCI Format Configuration (F0/SF0/0)

Bit Data: 0 0000 0000 0000

DCI Format 1C

UL/DL Configuration: 0000 0000...

If eIMTA is used, the DCI format 1C carries information about the UL/DL configuration numbers. Each UL/DL configuration number consists of 3 bits and indicates one of the configurations listed in [Figure 2-5](#).

The UL/DL configuration is defined as a bit pattern. The bit pattern length is selected so that the payload size of the DCI is equal to the payload size of the DCI format 1C, when it used for compact scheduling. If the configured pattern is shorter than the required, the remaining bits are filled with zeros.

DCI format 1C for eIMTA is supported in the common search space ([Search Space](#)) and in the PCell.

The fields defined in the DCI format are mapped to the information bits according to the 3GPP specification and the resulting **Bit Data** is displayed.

Remote command:

[:SOURCE<hw>] :BB:EUTRa:DL [:SUBF<st0>] :ENCC:PDCCh:EXTC:ITEM<ch0> :
DCIConf:ULDLconf on page 688

DCI Format 1C for LAA

Option: R&S SMM-K119

To enable this parameter, select "DCI Table" > **User** > "CC-RNTI".

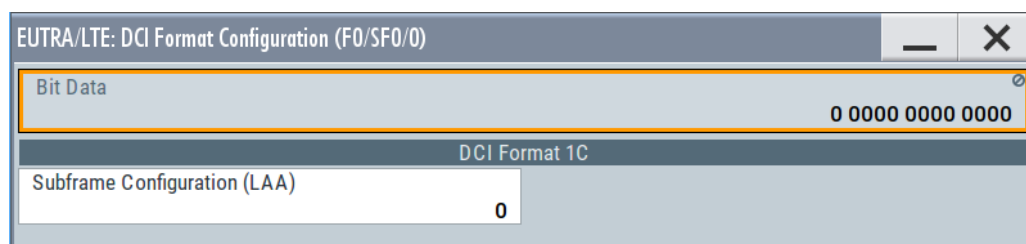

If LAA is used, the DCI format 1C carries information about the LAA subframe configuration.

Table 4-10: Subframe configuration for LAA in current and next subframe [36.211]

Value of "Subframe configuration for LAA" field in current subframe	Configuration of occupied OFDM symbols (current subframe, next subframe)
0000	(-,14)
0001	(-,12)
0010	(-,11)
0011	(-,10)
0100	(-,9)
0101	(-,6)
0110	(-,3)
0111	(14,*)
1000	(12,-)
1001	(11,-)
1010	(10,-)
1011	(9,-)
1100	(6,-)
1101	(3,-)
1110	reserved
1111	reserved

Where:

- (-, Y) means UE may assume the first Y symbols are occupied in next subframe and other symbols in the next subframe are not occupied.

- (X,-) means UE may assume the first X symbols are occupied in current subframe and other symbols in the current subframe are not occupied.
- (X,*) means UE may assume the first X symbols are occupied in current subframe, and at least the first OFDM symbol of the next subframe is not occupied.

DCI format 1C for LAA is supported in the common search space ([Search Space](#)) and in the SCell.

The fields defined in the DCI format are mapped to the information bits according to the 3GPP specification and the resulting [Bit Data](#) is displayed.

Remote command:

`[:SOURCE<hw>] :BB:EUTRa:DL [:SUBF<st0>] :ENCC:PDCCh:EXTC:ITEM<ch0> :DCIConf:LAASubframe` on page 647

DCI Format 1D

DCI format 1D is used for the compact scheduling of one PDSCH codeword with pre-coding and power offset information.

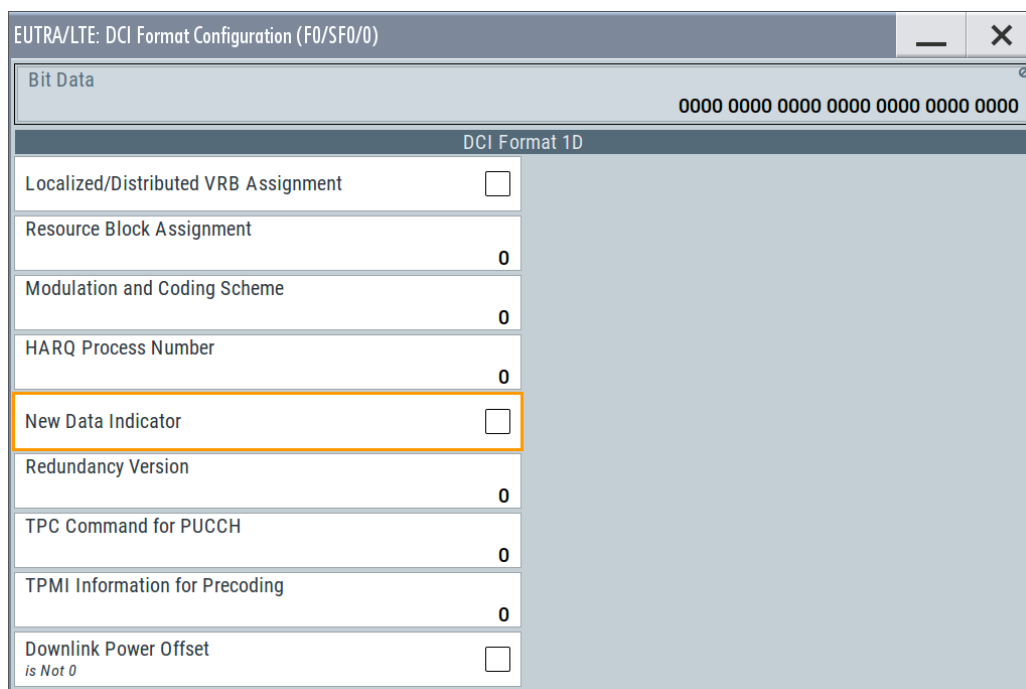

The fields defined in the DCI format are mapped to the information bits according to the 3GPP specification and the resulting [Bit Data](#) is displayed.

The DCI Format 1D transmits the information listed in the following table.

Control Information Field	SCPI command	Dependencies
"Carrier Indicator Field (CIF)"	<code>[:SOURCE<hw>] :BB:EUTRa:DL [:SUBF<st0>] :ENCC:PDCCh:EXTC:ITEM<ch0> :DCIConf:CIField</code> on page 676	See "Carrier Indicator Field (CIF)" on page 185
Localized/Distributed	<code>[:SOURCE<hw>] :BB:EUTRa:DL [:SUBF<st0>] :ENCC:PDCCh:EXTC:ITEM<ch0> :DCIConf:VRBA</code> on page 689	

Control Information Field	SCPI command	Dependencies
Resource Block Assignment	[:SOURCE<hw>] :BB:EUTRa:DL[:SUBF<st0>] :ENCC: PDCCh:EXTC:ITEM<ch0> :DCIConf:RBA on page 684	
GAP Value	[:SOURCE<hw>] :BB:EUTRa:DL[:SUBF<st0>] :ENCC: PDCCh:EXTC:ITEM<ch0> :DCIConf:GAP on page 679	"Channel Bandwidth >= 50RBs", "Distributed VBR Assignment" and "User = User x"
Modulation and Coding Scheme	[:SOURCE<hw>] :BB:EUTRa:DL[:SUBF<st0>] :ENCC: PDCCh:EXTC:ITEM<ch0> :DCIConf:MCSR on page 680	
HARQ Process Number	[:SOURCE<hw>] :BB:EUTRa:DL[:SUBF<st0>] :ENCC: PDCCh:EXTC:ITEM<ch0> :DCIConf:HPN on page 679	
New Data Indicator	[:SOURCE<hw>] :BB:EUTRa:DL[:SUBF<st0>] :ENCC: PDCCh:EXTC:ITEM<ch0> :DCIConf:NDI on page 681	
Redundancy Version	[:SOURCE<hw>] :BB:EUTRa:DL[:SUBF<st0>] :ENCC: PDCCh:EXTC:ITEM<ch0> :DCIConf:RV on page 684	
TPC Command for PUCCH	[:SOURCE<hw>] :BB:EUTRa:DL[:SUBF<st0>] :ENCC: PDCCh:EXTC:ITEM<ch0> :DCIConf:TPCC on page 687	
Downlink Assignment Index	[:SOURCE<hw>] :BB:EUTRa:DL[:SUBF<st0>] :ENCC: PDCCh:EXTC:ITEM<ch0> :DCIConf:DLAindex on page 678	TDD mode
TPMI Information for Precoding	[:SOURCE<hw>] :BB:EUTRa:DL[:SUBF<st0>] :ENCC: PDCCh:EXTC:ITEM<ch0> :DCIConf:TPMI on page 687	
Downlink Power Offset	[:SOURCE<hw>] :BB:EUTRa:DL[:SUBF<st0>] :ENCC: PDCCh:EXTC:ITEM<ch0> :DCIConf:DPOffset on page 679	

DCI Format 2/2A/2B/2C/2D

The DCI formats are used in the following cases:

- DCI format 2: for PDSCH scheduling in a spatial multiplexing configuration
- DCI format 2A: for PDSCH scheduling in a spatial multiplexing configuration, but without PMI feedback.
- DCI format 2B: in 2-, 4-Tx antenna configurations.
- DCI format 2C: in a multi-layer transmissions (Tx Mode 9).
- DCI format 2D: in a multi-layer transmissions (Tx Mode 10), using CoMP.

Since MIMO operation requires two codewords, the modulation and coding scheme, new data indicator and the redundancy version are signaled separately for each of the codewords. The spatial multiplexing also requires a transmission of precoding information.

The transport block to codeword mapping is performed according to the 3GPP specification: transport block 1 (TB1) is mapped to codeword 1/2 (CW1) and TB2 to codeword 2/2 (CW2). The "Transport Block to Codeword Swap Flag" determines the mapping in case both transport blocks are enabled. If this swap flag is enabled, the TB1 is mapped to CW2 and vice versa.

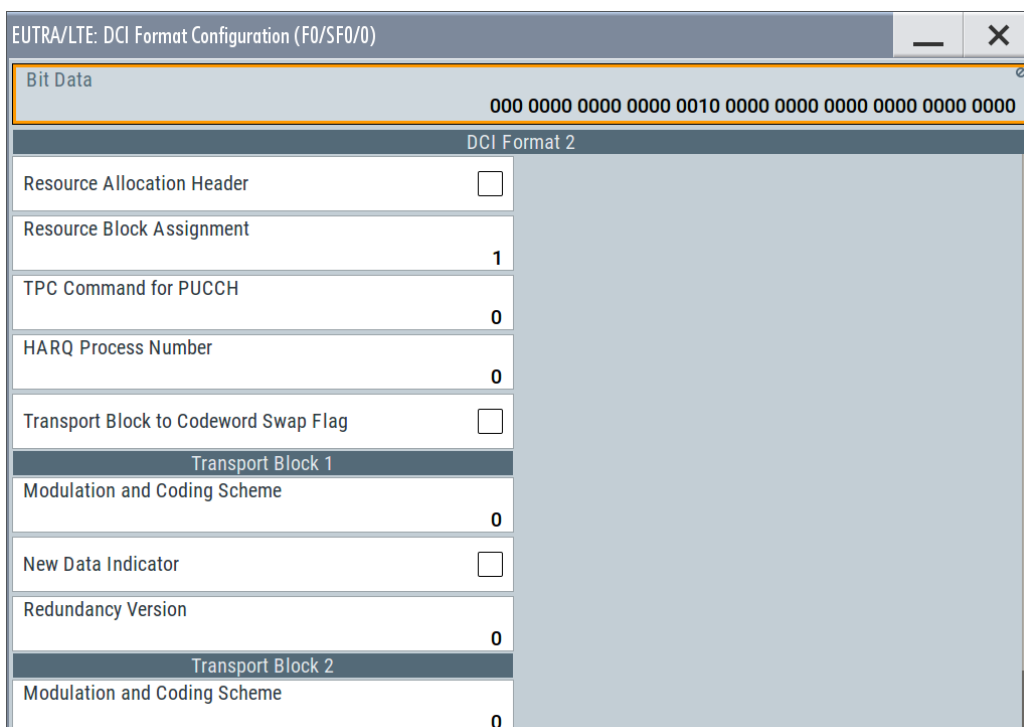

The fields defined in the DCI format are mapped to the information bits according to the 3GPP specification and the resulting **Bit Data** is displayed.

If the DCI format is used for validation of the semi-persistent scheduling (SPS) activation or release, some special DCI fields are predefined according to Tables 9.2 in **TS 36.213**. See also **Chapter 4.3.7, "SPS configuration settings"**, on page 153.

The DCI format 2D is required for downlink transmission using TM10 as the DCI format 2C is used for the TM9. The DCI format 2D is also similar to the format 2C but it carries additionally QCL (quasi-co-location) and rate matching information. The "PDSCH RE Mapping and QCL Indicator" is a two bit field that indicates one of four sets of parameters sets, as specified in the **TS 36.211**.

The DCI Format 2/2A/2B/2C/2D transmits the information listed in the following table.

Control Information Field	SCPI command	Dependencies
Carrier Indicator Field (CIF)	<code>[:SOURCE<hw>] :BB:EUTRa:DL[:SUBF<st0>] :ENCC: PDCCh:EXTC:ITEM<ch0> :DCIConf:CIField</code> on page 676	See " Carrier Indicator Field (CIF) " on page 185
Resource Allocation Header	<code>[:SOURCE<hw>] :BB:EUTRa:DL[:SUBF<st0>] :ENCC: PDCCh:EXTC:ITEM<ch0> :DCIConf:RAH</code> on page 683	"Channel Bandwidth > 10 RBs"
Resource Block Assignment	<code>[:SOURCE<hw>] :BB:EUTRa:DL[:SUBF<st0>] :ENCC: PDCCh:EXTC:ITEM<ch0> :DCIConf:RBA</code> on page 684	
TPC Command for PUCCH	<code>[:SOURCE<hw>] :BB:EUTRa:DL[:SUBF<st0>] :ENCC: PDCCh:EXTC:ITEM<ch0> :DCIConf:TPCC</code> on page 687	
Downlink Assignment Index	<code>[:SOURCE<hw>] :BB:EUTRa:DL[:SUBF<st0>] :ENCC: PDCCh:EXTC:ITEM<ch0> :DCIConf:DLAindex</code> on page 678	TDD mode

Control Information Field	SCPI command	Dependencies
HARQ Process Number	[:SOURCE<hw>] :BB:EUTRa:DL[:SUBF<st0>] :ENCC: PDCCh:EXTC:ITEM<ch0> :DCIConf:HPN on page 679	
Ant. Port(s), Layers, SCID	[:SOURCE<hw>] :BB:EUTRa:DL[:SUBF<st0>] :ENCC: PDCCh:EXTC:ITEM<ch0> :DCIConf:APLayer on page 675	DCI Format 2C/2D
Transport Block to Codeword Swap Flag	[:SOURCE<hw>] :BB:EUTRa:DL[:SUBF<st0>] :ENCC: PDCCh:EXTC:ITEM<ch0> :DCIConf:SWAPflag on page 685	DCI Format 2/2A
Scrambling Identity	[:SOURCE<hw>] :BB:EUTRa:DL[:SUBF<st0>] :ENCC: PDCCh:EXTC:ITEM<ch0> :DCIConf:SID on page 686	DCI Format 2B
Precoding Information	[:SOURCE<hw>] :BB:EUTRa:DL[:SUBF<st0>] :ENCC: PDCCh:EXTC:ITEM<ch0> :DCIConf:PRECinfo on page 682	DCI Format 2/2A
SRS Request	[:SOURCE<hw>] :BB:EUTRa:DL[:SUBF<st0>] :ENCC: PDCCh:EXTC:ITEM<ch0> :DCIConf:SRSRequest on page 684	DCI Format 2B and TDD mode
"Transport Block 1"		
Modulation and Coding Scheme	[:SOURCE<hw>] :BB:EUTRa:DL[:SUBF<st0>] :ENCC: PDCCh:EXTC:ITEM<ch0> :DCIConf:TB1:MCS on page 685	
New Data Indicator	[:SOURCE<hw>] :BB:EUTRa:DL[:SUBF<st0>] :ENCC: PDCCh:EXTC:ITEM<ch0> :DCIConf:TB2:NDI on page 685	
Redundancy Version	[:SOURCE<hw>] :BB:EUTRa:DL[:SUBF<st0>] :ENCC: PDCCh:EXTC:ITEM<ch0> :DCIConf:TB1:RV on page 686	
"Transport Block 2"		
Modulation and Coding Scheme	[:SOURCE<hw>] :BB:EUTRa:DL[:SUBF<st0>] :ENCC: PDCCh:EXTC:ITEM<ch0> :DCIConf:TB2:MCS on page 685	
New Data Indicator	[:SOURCE<hw>] :BB:EUTRa:DL[:SUBF<st0>] :ENCC: PDCCh:EXTC:ITEM<ch0> :DCIConf:TB2:NDI on page 685	
Redundancy Version	[:SOURCE<hw>] :BB:EUTRa:DL[:SUBF<st0>] :ENCC: PDCCh:EXTC:ITEM<ch0> :DCIConf:TB2:RV on page 686	
PDSCH RE Mapping and QCL (quasi-co-location) Indicator	[:SOURCE<hw>] :BB:EUTRa:DL[:SUBF<st0>] :ENCC: PDCCh:EXTC:ITEM<ch0> :DCIConf:PDRE on page 681	DCI Format 2D
HARQ-ACK Resource Offset	[:SOURCE<hw>] :BB:EUTRa:DL[:SUBF<st0>] :ENCC: PDCCh:EXTC:ITEM<ch0> :DCIConf:HACK on page 680	If EPDCCH is used

DCI Format 3/3A

The DCI Format 3/3A is used for the transmission of TPC Commands for PUCCH and PUSCH with 2-bit and a single bit power adjustment respectively.

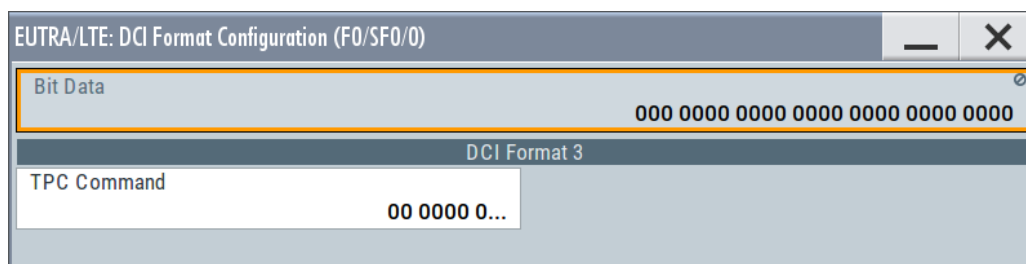

The "TPC Command" is set as a bit pattern.

The fields defined in the DCI format are mapped to the information bits according to the 3GPP specification and the resulting **Bit Data** is displayed.

Remote command:

[:SOURCE<hw>] :BB:EUTRa:DL[:SUBF<st0>] :ENCC:PDCCh:EXTC:ITEM<ch0> :
DCIConf:TPCinstr on page 687

4.4 Enhanced PBCH, PDSCH and PMCH settings

Access:

1. Select "General > Link Direction > Downlink (OFDMA)".
2. Select "Frame Configuration > Subframe > No of Used Allocations = 3".
3. Select "Allocation Table > Allocation#3 > Content Type".
4. Select one of the following "Content Type":
 - a) "PBCH"
 - b) "PDSCH"
 - c) "PMCH"
5. Select "Enhanced Settings > Config..."

In the "Enhanced Settings" dialog, you can define the precoding and the channel coding settings for the DL channels PBCH and PDSCH. The settings are configurable on a subframe basis.

Consider the following interdependencies:

- The "Precoding" settings are available for the first codeword and applied for both codewords.
- The available "Precoding" settings depend on:
 - The global MIMO configuration
 - The content of the allocation
 - The selected codeword
- For all allocations, where the "Data Source > User x":
 - The following parameters are read-only: "Scrambling State", "UE ID" and "Channel Coding State".

To configure these parameters, open the [User configuration settings](#) dialog for the corresponding user.

- You can access the "Enhanced Settings" of one particular "User 1..4" from any allocations belonging to this user.

4.4.1 Precoding settings

Access:

1. Select "General DL Configuration > Antenna Ports"
2. Select "Global MIMO Configuration > 2 TxAntennas"
3. Select "General > Frame Configuration > Subframe > No of Used Allocations = 3".
4. Select "Allocation Table > Allocation#3 > Content Type".
5. Select "Content Type > PDSCH"
6. Select "Enhanced Settings > Config..."

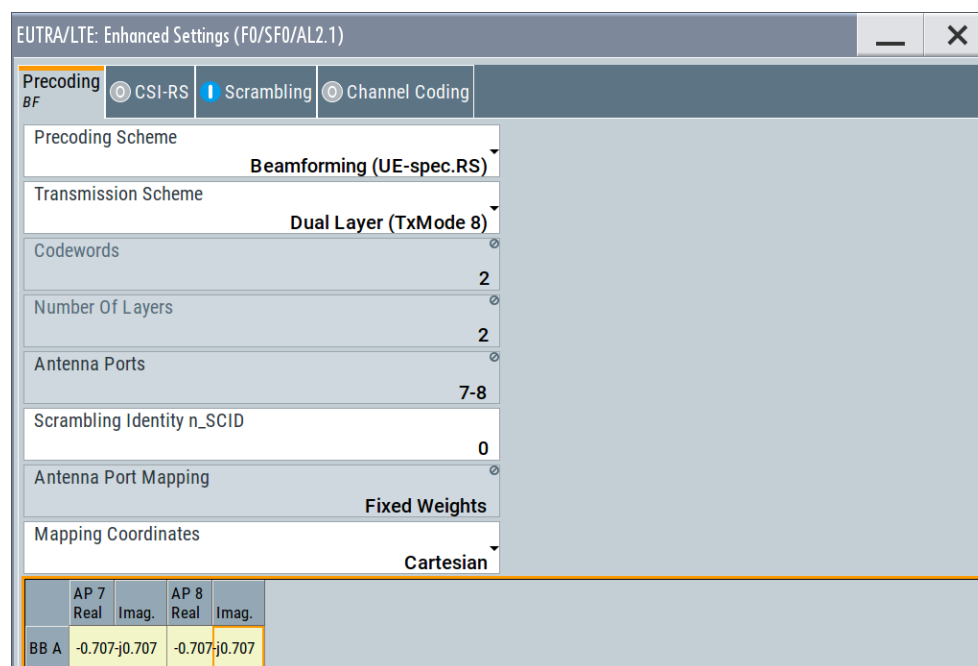

Consider the following interdependencies:

- The "Precoding" settings are available for the first codeword and applied for both codewords.
- The available "Precoding" settings depend on:
 - The global MIMO configuration
 - The content of the allocation
 - The selected codeword

Precoding Scheme.....	204
Transmission Scheme.....	204
Codeword.....	205
Number of Layers.....	205
Scrambling Identity n_SCID.....	206
Antenna Ports.....	206
Antenna Port Mapping.....	206
Use Alternative Codebooks.....	206
Codebook Index/Codebook Index 2.....	207
Cyclic Delay Diversity.....	207
Mapping Coordinates.....	207
Mapping Table.....	208

Precoding Scheme

Selects the precoding scheme.

Note: The available precoding schemes depend on [Content Type](#) and the [MIMO Configuration](#).

"None"	Disables precoding.
"Spatial Multiplexing/Tx Diversity"	Precoding for spatial multiplexing or transmit diversity is performed according to TS 36.211 and the selected parameters.
"Beamforming (UE-spec.RS)"	Sets the PDSCH to transmission mode selected with the parameter Transmission Scheme .
"Antenna Port 4"	Option: R&S SMM-K84 Default precoding scheme for the PMCH transmitted in MBFSN sub-frames.

Remote command:

```
[ :SOURce<hw> ] :BB:EUTRa:DL [ :SUBF<st0> ] :ALLoc<ch0> [ :CW<user> ] :
PRECoding:SCHEME on page 654
```

Transmission Scheme

Option: R&S SMM-K84/K85/K112

Determines the transmission scheme (see also [Table 2-6](#)).

"Transmission Scheme"	Available for Global MIMO Configuration	Description
"Single Layer (TxMode 7)"	SISO+BF 2Tx/4Tx-Antennas	Option: R&S SMM-K84 Sets the PDSCH to transmission mode 7, as described in TS 36.213 , i.e. UE-specific RS (DM-RS) are added to the PDSCH. This special mode is defined for transmission using antenna port 5. Tip: To enable the instrument to generate a transmission using antenna port 5 signal, select "Global MIMO Configuration > SISO + BF" Antenna port 5 transmission is also known as transmission corresponding to the UE-specific reference signal. It is defined in the TS 36.101 , chapter 8.3.
"Dual layer (TxMode 8)"	SISO+BF 2Tx/4Tx-Antennas	Option: R&S SMM-K84 Sets the PDSCH to transmission mode 8, as described in TS 36.213 , i.e. UE-specific RS are added to the PDSCH. In this mode, antenna ports 7 and 8 are used. Tip: To enable the instrument to generate a transmission using antenna port 7 and 8, set the parameter "Global MIMO Configuration" to "SISO + BF", "2 Tx-antennas" or "4 Tx-antennas".
"Multi-layer (TxMode 9)"	SISO+BF 2Tx/4Tx-Antennas	Option: R&S SMM-K85 Sets the PDSCH to transmission mode 9. Depending on the used layers, antenna ports 7 to 14 are used.
"Multi-layer, CoMP (TxMode 10)"	SISO+BF 2Tx/4Tx-Antennas	Option: R&S SMM-K112 Sets the PDSCH to transmission mode 10, used for multi-layer transmissions combined with CoMP (coordinated multi-point operation). Depending on the used layers, antenna ports 7 to 14 are used.

Remote command:

```
[ :SOURce<hw> ] :BB:EUTRa:DL [ :SUBF<st0> ] :ALLoc<ch0> [ :CW<user> ] :
PRECoding:TRSScheme on page 655
```

Codeword

Displays the number of the codeword and the total number of codewords used for the selected allocation.

Remote command:

```
[ :SOURce<hw> ] :BB:EUTRa:DL [ :SUBF<st0> ] :ALLoc<ch0> :CODWords
on page 606
```

Number of Layers

Sets/displays the number of layers for the selected allocation.

The number of available layers depends on selected [Content Type](#) and [Precoding Scheme](#)

The combination of number of codewords and number of layers determines the layer mapping for the selected precoding scheme, see also "[Codewords and spatial layers](#)" on page 41.

Remote command:

```
[ :SOURce<hw> ] :BB:EUTRa:DL [ :SUBF<st0> ] :ALLoc<ch0> [ :CW<user> ] :
PRECoding:NOLayers on page 653
```

Scrambling Identity n_SCID

Sets the scrambling identity according to [TS 36.211](#).

This value is used for initialization of the sequence used for generation of the UE-specific reference signals.

Remote command:

```
[ :SOURce<hw> ] :BB:EUTRa:DL [ :SUBF<st0> ] :ALLoc<ch0> [ :CW<user> ] :
PRECoding:SCID on page 654
```

Antenna Ports

Option: R&S SMM-K84

Displays and configures the antenna ports for the selected [Transmission Scheme](#).

See also "[Mapping table](#)" on page 215.

If one of the multi-layer modes is configured to use one codeword (i.e. one layer), the mapping of the layer to the antenna ports (7 to 9) is configurable.

Tip: Use this setting to configure a dual-layer multi-user MIMO (MU-MIMO) scenario.

Remote command:

```
[ :SOURce<hw> ] :BB:EUTRa:DL [ :SUBF<st0> ] :ALLoc<ch0> [ :CW<user> ] :
PRECoding:AP on page 651
```

Antenna Port Mapping

Option: R&S SMM-K84/K85

Sets the way that the logical antenna ports are mapped to the physical TX antennas, see [Chapter 4.5, "DL antenna port mapping settings"](#), on page 213.

Remote command:

```
[ :SOURce<hw> ] :BB:EUTRa:DL [ :SUBF<st0> ] :ALLoc<ch0> [ :CW<user> ] :
PRECoding:APM on page 651
```

Use Alternative Codebooks

Option: R&S SMM-K113)

This parameter applies the enhanced 4 Tx codebook and is enabled if the following applies:

- [Transmission Scheme](#) > "Tx Mode 8/Tx Mode 9/Tx Mode 10" (dual- or multi-layer transmission) and
- [Global MIMO Configuration](#) = "4 TxAntennas"

The enhanced 4 Tx codebook is part of the further downlink MIMO enhancements feature proposed in LTE-A Rel. 12; see "[Further DL MIMO enhancements \(enhanced 4Tx codebook\)](#)" on page 53.

"Off" Applied is the normal codebook, as specified in [TS 36.211](#).

"On" Applied is the enhanced 4Tx codebook, as specified in TS 36.213.
Tip: Toggle the parameter "Use Alternative Codebooks" and observe the effect on the values in the [Mapping table](#).

Remote command:

```
[ :SOURCE<hw> ] :BB:EUTRa:DL [ :CELL<ccidx> ] [ :SUBF<st0> ] :ALLoc<ch0> :
PUSCh:PRECoding:CBUA on page 652
```

Codebook Index/Codebook Index 2

Enabled if:

- [Precoding Scheme](#) > "TX Diversity or Spatial Multiplexing"
- "Codeword = 1/2"
- "Antenna Port Mapping > Codebook"
- "User Specific Antenna Port Mapping" > [Constant Codebook Index](#) > "Off"
 If "Constant Codebook Index > On", the "Codebook Index/Codebook Index 2" is set automatically to the values set in the "User Specific Antenna Port Mapping" dialog.

Sets the codebook index for the selected allocation and selects the predefined pre-coder matrix.

The number of available codebook indices depends on the number of antenna ports with mapped user-specific reference symbols, the number of layers and number of Tx antennas per component carrier.

[Figure 2-23](#) shows the range of the codebook index for downlink spatial multiplexing for LTE Rel. 8/9. The LTE Rel. 10 (R&S SMM-K85) defines up to eight layers and uses the same principles.

The combination of codebook index and the selected [Number of Layers](#) determines the pre-coding matrix used for precoding.

Remote command:

```
[ :SOURCE<hw> ] :BB:EUTRa:DL [ :SUBF<st0> ] :ALLoc<ch0> [ :CW<user> ] :
PRECoding:CBINdex [ <dir> ] on page 652
```

Cyclic Delay Diversity

(Enabled for [Precoding Scheme](#) set to TX Diversity or Spatial Multiplexing and codeword 1/2 only)

Sets the CDD for the selected allocation.

The combination of cyclic delay diversity and the selected [Number of Layers](#) determines the precoding parameters for spatial multiplexing.

Remote command:

```
[ :SOURCE<hw> ] :BB:EUTRa:DL [ :SUBF<st0> ] :ALLoc<ch0> [ :CW<user> ] :
PRECoding:CDD on page 653
```

Mapping Coordinates

Switches between the "Cartesian" and "Cylindrical" coordinates representation.

Remote command:

```
[ :SOURCE<hw> ] :BB:EUTRa:DL [ :SUBF<st0> ] :ALLoc<ch0> [ :CW<user> ] :
PRECoding:DAFormat on page 653
```

Mapping Table

Option: R&S SMM-K84

Defines the mapping of the antenna ports (AP) to the physical antennas, see "[Mapping table](#)" on page 218.

4.4.2 CSI-RS settings

Access:

- ▶ Select "Enhanced Settings > CSI-RS".

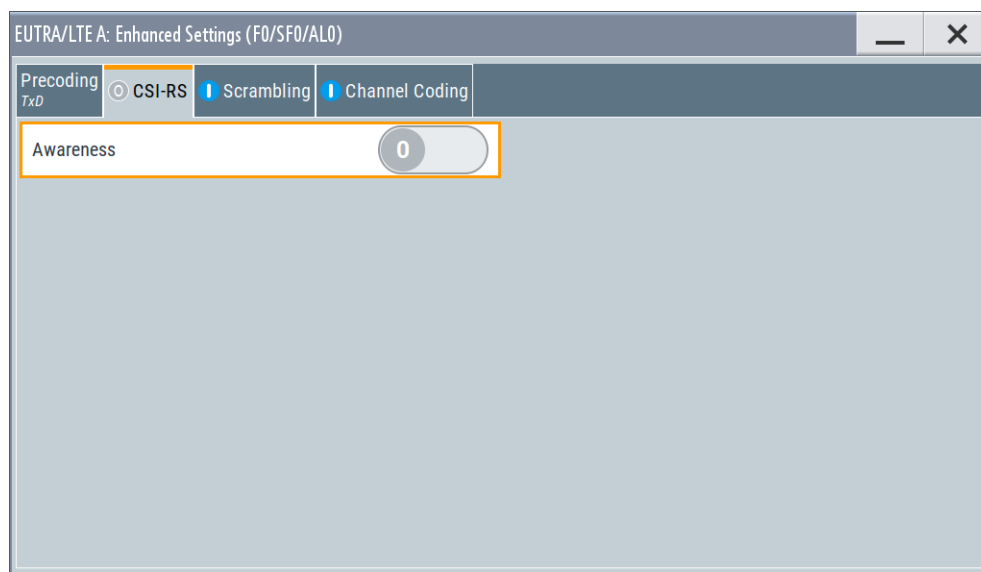

In this dialog, the CSI awareness can be enabled/disabled.

CSI Awareness

Determines the way the PDSCH is processed.

- "On" During the channel coding, the resource elements configured for the CSI-RS transmission are explicitly avoided and the PDSCH is mapped only on the available physical bits.
- "Off" The channel coding is performed as if the CSI-RS is not transmitted. The PDSCH mapping is not modified to avoid the resource elements on that the CSI-RS can be transmitted. The modulation symbols necessary for the transmission of the CSI-RS are subsequently substituted by the CSI-RS information; the CSI-RS are transmitted instead of the PDSCH symbols. This process leads to increased bit error rate, but an UE receiving this PDSCH can still decode the information correctly.

Remote command:

[:SOURce<hw>] :BB:EUTRa:DL [:SUBF<st0>] :ALLoc<ch0>:CAW on page 649

4.4.3 Scrambling settings

Access:

- ▶ Select "Enhanced Settings > Scrambling".

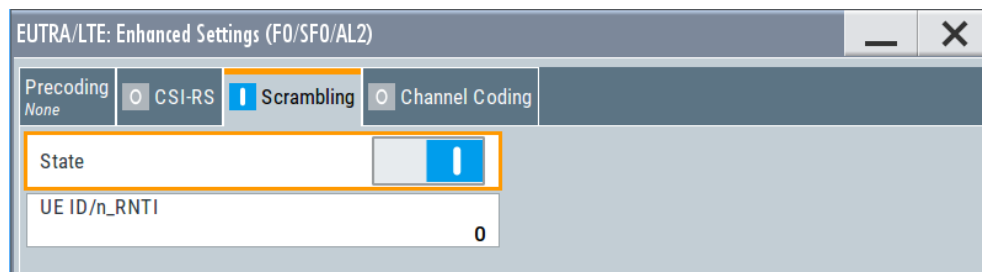

This dialog comprises the settings needed for configuring the scrambling:

State Scrambling (DL).....	209
UE ID/n_RNTI (PDSCH).....	209

State Scrambling (DL)

Enables/disables the bit-level scrambling.

If a "User x" is selected as [Data Source](#) in the allocation table for the corresponding allocation, the "State Scrambling" is read only. Its value is displayed as set in the [User configuration settings](#) dialog for the corresponding user.

Remote command:

```
[ :SOURce<hw> ] :BB:EUTRa:DL [ :SUBF<st0> ] :ALLoc<ch0> [ :CW<user> ] :
SCRambling:STATe on page 655
```

UE ID/n_RNTI (PDSCH)

Sets the user equipment identifier (n_RNTI) of the user to which the PDSCH transmission is intended. The UE ID is used to calculate the scrambling sequence.

If a "User x" is selected as [Data Source](#) in the allocation table for the corresponding allocation, the "UE ID" is read only. Its value is displayed as set in the [User configuration settings](#) dialog for the corresponding user.

Remote command:

```
[ :SOURce<hw> ] :BB:EUTRa:DL [ :SUBF<st0> ] :ALLoc<ch0> [ :CW<user> ] :
SCRambling:UEID on page 655
```

4.4.4 Channel coding settings

Access:

- ▶ Select "Enhanced Settings > Channel Coding".

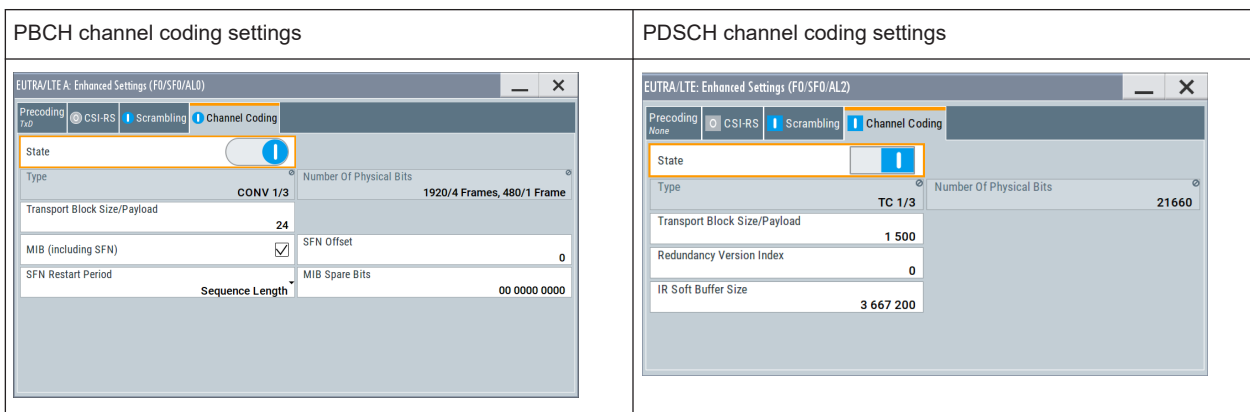

This dialog comprises the settings needed for configuring the channel coding. The settings vary according to the selected "Content Type"

State Channel Coding (DL).....	210
Type Channel Coding (DL).....	211
Number of Physical Bits (DL).....	211
MIB (including SFN).....	211
SFN Offset.....	211
SFN Restart Period.....	212
MIB Spare Bits.....	212
Transport Block Size/Payload (DL).....	212
Redundancy Version Index (PDSCH).....	212
IR Soft Buffer Size (PDSCH).....	212

State Channel Coding (DL)

Enables/disables channel coding for the selected allocation and codeword.

For any allocation with [Data Source](#) > "User x", the "Channel Coding State" is read only. The value is set in the [User configuration settings](#) dialog for the corresponding user.

A PBCH can be generated in one of the following modes:

- Without channel coding, i.e. this parameter is disabled.
Dummy data or user-defined data lists are used.
- Channel coding with arbitrary transport block content
Channel coding is activated and parameter [MIB \(including SFN\)](#) is disabled.
- Channel coding with real data (MIB) including SFN
Channel coding and MIB are activated.

For the PBCH allocation with activated channel coding, one block of data (transport block size TBS of 24) is coded jointly and then spread over four frames. Set the ARB sequence length to a value that is a multiple of four.

Remote command:

```
[ :SOURce<hw> ] :BB:EUTRa:DL [ :SUBF<st0> ] :ALLoc<ch0> [ :CW<user> ] :
CCODing:STATe on page 650
```

Type Channel Coding (DL)

Displays the used channel coding scheme and channel coding rate.

PBCH uses always tail biting convolution coding with code rate 1/3; PDSCH uses always turbo code with code rate 1/3.

Remote command:

n.a.

Number of Physical Bits (DL)

Displays the size of the selected allocation in bits and considering the subcarriers that are used for other signals or channels with higher priority (see [Chapter A, "Conflict handling"](#), on page 943).

For [Data Source](#) > "User x", the value of the parameter "Number of Physical Bits" is the sum of the "Physical Bits" of all allocations of the same user in the selected sub-frame.

The size of the PBCH allocation is fixed to 1920/4 Frames, 480/1 Frame.

Remote command:

```
[ :SOURce<hw> ] :BB:EUTRa:DL [ :SUBF<st0> ] :ALLoc<ch0> [ :CW<user> ] :
PHYSbits? on page 609
[ :SOURce<hw> ] :BB:EUTRa:DL [ :SUBF<st0> ] :USER<ch> :PHYSbits?
on page 612
```

MIB (including SFN)

(for PBCH only)

Enables transmission of real MIB (master information block) data, calculated according to the values of the following "General DL Settings" parameters:

- [Channel Bandwidth](#)
- [PHICH Duration](#)
- [PHICH N_g](#)

The SFN (system frame number) is included as well.

If this parameter is enabled, the "[Transport Block Size](#)" is fixed to 24 and the [Data Source](#) for the PBCH allocation is set to "MIB".

Remote command:

```
[ :SOURce<hw> ] :BB:EUTRa:DL:PBCH:MIB on page 648
```

SFN Offset

(for PBCH only)

By default, the counting of the SFN (system frame number) starts with 0. Use this parameter to set a different start SFN value.

Remote command:

```
[ :SOURce<hw> ] :BB:EUTRa:DL:PBCH:SOFFset on page 648
```

SFN Restart Period

Option: R&S SMM-K84

Determines the time span after which the SFN (system frame number) restarts.

"Sequence Length"

The SFN restart period is equal to the ARB sequence length.

"3GPP (1024 Frames)"

The PBCH including SFN is calculated independently from the other channels. The SFN restarts after 1024 frames and the generation process is fully 3GPP compliant, but the calculation can take long time.

Tip: Use the "3GPP (1024 Frames)" mode only if 3GPP compliant SFN period is required.

This mode is disabled if a baseband generates more than one carrier.

Remote command:

[\[:SOURCE<hw>\]:BB:EUTRa:DL:PBCH:SRPeriod](#) on page 648

MIB Spare Bits

Sets the 10 spare bits in the PBCH transmission.

Remote command:

[\[:SOURCE<hw>\]:BB:EUTRa:DL:PBCH:MSPare](#) on page 649

Transport Block Size/Payload (DL)

Defines the size of the transport block/payload in bits.

- One transport block is generated and spread over all allocations. If "Data Source = User x", the parameters "Transport Block Size", "Redundancy Version Index" and "IR Soft Buffer Size" are related to all allocations of the same user in the subframe.
- In case a spatial multiplexing with two codewords is configured, individual transport blocks for the two code blocks are generated.
- For PBCH allocations with enabled parameter [MIB \(including SFN\)](#), the transport block size is fixed to 24.
Set the transport block size to 24 if a generation compliant to the 3GPP specifications is required.

Remote command:

[\[:SOURCE<hw>\]:BB:EUTRa:DL\[:SUBF<st0>\]:ALLoc<ch0>\[:CW<user>\]:CCODing:TBSize](#) on page 650

Redundancy Version Index (PDSCH)

Sets the redundancy version index.

Remote command:

[\[:SOURCE<hw>\]:BB:EUTRa:DL\[:SUBF<st0>\]:ALLoc<ch0>\[:CW<user>\]:CCODing:RVIndex](#) on page 650

IR Soft Buffer Size (PDSCH)

Sets the size of the IR soft buffer for the selected transport block (N_IR from [TS 36.212](#)).

Remote command:

```
[ :SOURCE<hw> ] :BB:EUTRa:DL [ :SUBF<st0> ] :ALLoc<ch0> [ :CW<user> ] :
CCODing:ISBSize on page 649
```

4.5 DL antenna port mapping settings

The 3GPP standard defines the different antenna ports for transmission in different transmission modes (TM, also "TxMode") and for the transmission of different reference signals. See [Table 2-6](#) and [Chapter 2.2.1.5, "Downlink reference signal structure and cell search"](#), on page 25.

The settings necessary to configure the reference signals and to enable the transmission modes are distributed among different dialogs, depending on their type (cell-specific, user-specific, etc.). The related antenna port mapping settings are distributed in these dialogs, too.

To set the cell-specific antenna port mapping settings

1. Select "General > Link Direction > Downlink (OFDMA)".
2. Select "General DL Settings > Antenna Ports".

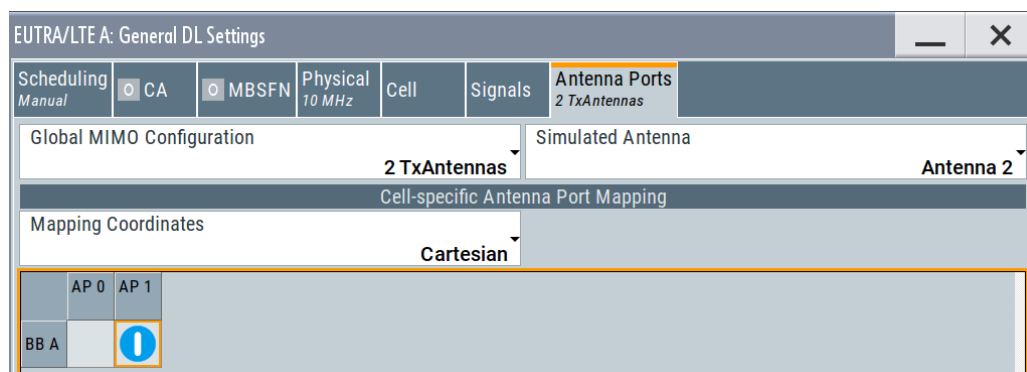

To set the user-specific antenna port settings

- ▶ Select "Frame Configuration > General > User > Antenna Mapping > Config".

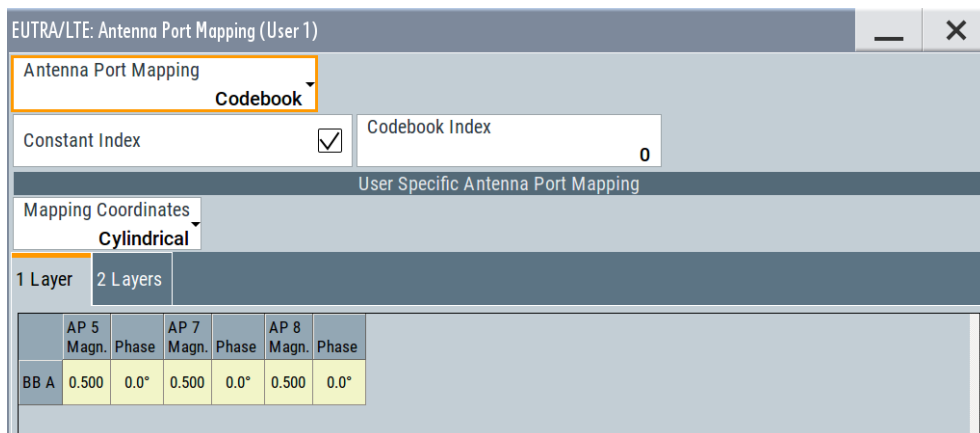

The available antenna ports and layers depend on the number of antennas and the transmission mode the UE is working in ("Frame Configuration > General > User > Tx Mode")

To configure the PDSCH belonging to a particular user

1. Select "Frame Configuration > General > User > User 1 > Tx Mode > e.g. Mode 9".
2. Select "Frame Configuration > Subframe > Subframe Selection#0 > No. of Used Allocation = 3".
3. Select "Frame Configuration > Subframe > Allocation Table > All#2 > Data Source > UE1".
4. Select "Frame Configuration > Subframe > Allocation Table > All#2 > Enh. PDSCH Settings > Precoding".

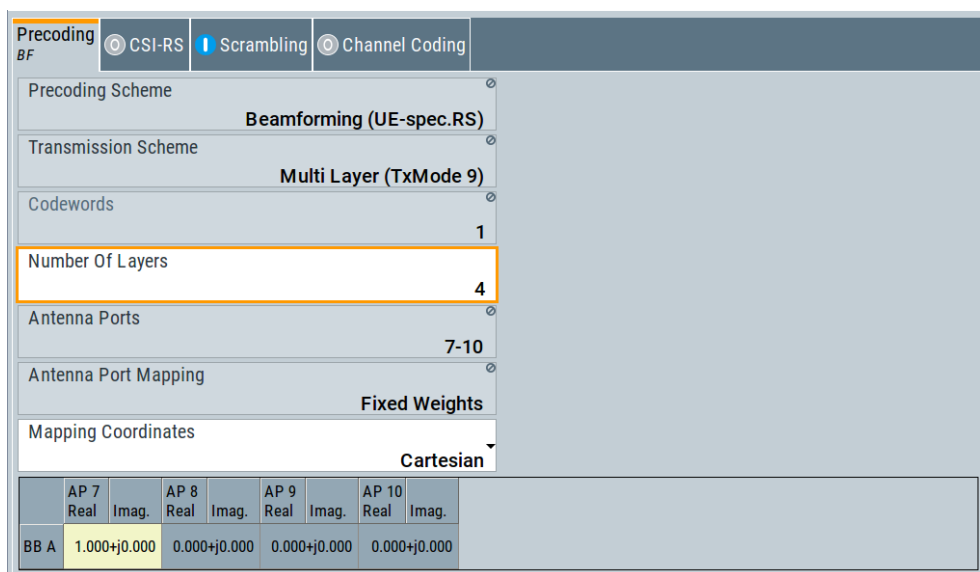

Refer to [Chapter 4.4.1, "Precoding settings"](#), on page 203 for description of the provided settings.

The dialogs shown in ["To set the cell-specific antenna port mapping settings"](#) on page 213, ["To set the user-specific antenna port settings"](#) on page 214 and ["To configure the PDSCH belonging to a particular user"](#) on page 214 comprise the settings necessary to configure the mapping of the logical antenna ports to the physical TX antennas (Basebands). The number of physical antennas is set with the parameter "General DL Settings" > [Global MIMO Configuration](#).

The dialogs consist of two parts, a mapping table and a selection about the way the antenna mapping is performed. The yellow matrix elements in the mapping table indicate the default antenna port to physical antenna (TX antenna/baseband) mapping.

Mapping methods

The antenna mapping can be performed according to one of the following three methods:

- "Codebook"
The used precoding weights are according to the [TS 36.211](#), table 6.3.4.2.3-1 resp. 6.3.4.2.3-2. The selected element is defined by the selected codebook index and the number of layers.
- "Random codebook"
The precoding weights are selected randomly from the tables defined for the codebook method.
- "Fixed weight"
A fixed precoding weight can be defined which is used for all allocations of the according "User" throughout the frame.

Depending on the selected mapping method, the mapping table is invisible ("Random codebook"), read-only ("Codebook") or full configurable ("Fixed weight").

Mapping table

The mapping table is a matrix with number of rows equal to the number of physical Tx antennas and number of columns equal of the number of antenna ports (AP). The available antenna ports depend on the current configuration.

- Antenna Port AP4 is reserved for the MBSFN RS ("General DL Settings > MBSFN > State > Mixed") and per default mapped to "BB A".
- Antenna Port AP5 is reserved for the UE-specific RS (DM-RS) in TM7, AP7/AP8 are reserved for TM8 ("Frame Configuration > General > User Configuration > Antenna Mapping > Config")
- Antenna Port AP6 is reserved for the PRS ("General DL Settings > PRS > State > On") and per default mapped to "BB A".
- Antenna Ports AP9 to AP14 are used by TM9 ("Frame Configuration > General > User > Antenna Mapping > Config")
- Antenna Ports AP15 to AP22 are reserved for CSI-RS (up to LTE Rel. 13)
Option: R&S SMM-K85

("General DL Settings > Signals > CSI-RS" > [CSI-RS State](#) > "On" and [Number of AP per CSI-RS Configuration](#))

The number of antenna ports corresponds to the maximum "Number of CSI-RS Antenna Ports", selected for any active cell with active CSI-RS or active DRS carrying CSI-RS.

- Option: R&S SMM-K112
Antenna Ports AP107 to AP110 are reserved for EPDCCH
("Frame Configuration > General > User": "Tx Modex > TM10",
[EPDCCH > Config](#) > "Activate EPDCCH > On" and "Antenna Mapping > Config")
- Option: R&S SMM-K115
Antenna Ports AP7 or AP8 are used for the transmission of eMTC PDSCH
Antenna Ports AP107 to AP110 are reserved for MPDCCH
Antenna Ports AP2000 and AP2001 are reserved for the NB-IoT reference signal NRS

Cell-Specific Antenna Port Mapping	216
L Mapping Coordinates	216
L Mapping table	216
User-Specific Antenna Port Mapping	217
L Antenna Port Mapping	217
L Constant Codebook Index	217
L Codebook Index/Codebook Index 2	218
L Use Alternative Codebooks	218
L Cell	218
L Mapping Coordinates	218
L Mapping table	218

Cell-Specific Antenna Port Mapping

Option: R&S SMM-K84/K85

Comprises the settings for defining the mapping of the logical antenna ports to the available physical TX antennas (Baseband).

Mapping Coordinates ← Cell-Specific Antenna Port Mapping

Switches representation between the "Cartesian (Real/Imag)" and "Cylindrical (Magn./Phase)" coordinates.

Remote command:

[:SOURce<hw>] :BB:EUTRa:DL:MIMO:APM:MAPCoordinates on page 581

Mapping table ← Cell-Specific Antenna Port Mapping

Defines the mapping of the antenna ports (AP) to the physical antennas, see "[Mapping table](#)" on page 215.

The column "Cell" defines which baseband generates which cell, in the following cases:

- Carrier aggregation is activated
("EUTRA/LTE > General DL Settings > CA > Activate Carrier Aggregation > On")

The default mapping is selected to fit the current configuration but it can be changed afterwards.

Remote command:

[:SOURCE<hw>] :BB:EUTRa:DL:MIMO:APM:CS:CELL:BB<st0> on page 581

[:SOURCE<hw>] :BB:EUTRa:DL:MIMO:APM:CS:AP<dir0>:ROW<st0>:REAL
on page 582

[:SOURCE<hw>] :BB:EUTRa:DL:MIMO:APM:CS:AP<dir0>:ROW<st0>:
IMAGinary on page 582

User-Specific Antenna Port Mapping

Comprises the settings for defining the mapping of the logical APs to the available physical TX antennas.

Antenna Port Mapping ← User-Specific Antenna Port Mapping

Defines the antenna port mapping method, see [Mapping Methods](#).

Remote command:

[:SOURCE<hw>] :BB:EUTRa:DL:USER<ch>:APM:MODE on page 731

Constant Codebook Index ← User-Specific Antenna Port Mapping

For "Antenna Port Mapping > Codebook", defines whether the codebook index is set globally or per subframe.

Example:

Configure the settings as described in "[To configure the PDSCH belonging to a particular user](#)" on page 214.

- In the "User Specific Antenna Port Mapping" dialog:
 - Set "Antenna Port Mapping > Codebook"
 - Set "**Constant Codebook Index > On**"
 - Set the "Codebook Index/Codebook Index 2" values.

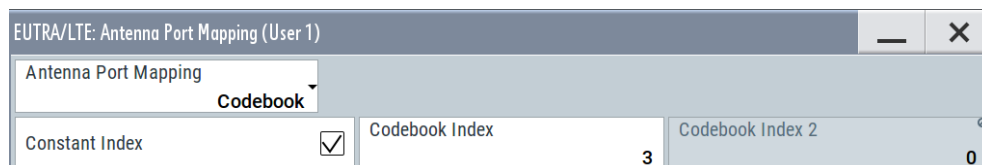

- Open the "Frame Configuration > Subframe > Allocation Table > All#2 > Enh. PDSCH Settings > Precoding" dialog. Observe the "Codebook Index/Codebook Index 2" values. The values are set automatically to the values set in the "Antenna Port Mapping" dialog.
- In the "User Specific Antenna Port Mapping" dialog, set "**Constant Codebook Index > Off**".
- In the "Frame Configuration > Subframe > Allocation Table > All#2 > Enh. PDSCH Settings > Precoding" dialog, set the "Codebook Index/Codebook Index 2" values.

"On" Set the codebook index with the parameters [Codebook Index/Codebook Index 2](#).
The values are constant and are used in all subframes for any PUSCH transmission of the particular user ("PUSCH Data Source > User x").

"Off" Set the codebook index with the parameters "Enhanced PDSCH Settings" > [Codebook Index/Codebook Index 2](#)
The values are set on a per subframe basis.

Remote command:

`[:SOURCE<hw>] :BB:EUTRa:DL:USER<ch>:APM:CBCI` on page 729

Codebook Index/Codebook Index 2 ← User-Specific Antenna Port Mapping

For "Antenna Port Mapping > Codebook" and "Constant Codebook Index > On", sets the codebook index for codebook mapping method.

The codebook index values are constant are used in all subframes for any PUSCH transmission of the particular user.

Remote command:

`[:SOURCE<hw>] :BB:EUTRa:DL:USER<ch>:APM:CBIndex [<dir>]` on page 730

Use Alternative Codebooks ← User-Specific Antenna Port Mapping

Option: R&S SMM-K113

This parameter applies the enhanced four Tx codebook and is enabled if the following applies:

- [Transmission Scheme](#) > "Tx Mode 8/Tx Mode 9/Tx Mode 10" (dual- or multi-layer transmission) and
- [Global MIMO Configuration](#) = "4 TxAntennas"

The enhanced 4 Tx codebook is part of the further downlink MIMO enhancements feature proposed in LTE Rel. 12; see "[Further DL MIMO enhancements \(enhanced 4Tx codebook\)](#)" on page 53.

"Off" Applied is the normal codebook, as specified in [TS 36.211](#).

"On" Applied is the enhanced 4Tx codebook, as specified in [TS 36.213](#).
Tip: Toggle the parameter and observe the effect on the values in the [Mapping table](#).

Remote command:

`[:SOURCE<hw>] :BB:EUTRa:DL:USER<ch>:APM:CBUA` on page 729

Cell ← User-Specific Antenna Port Mapping

Indicates the cell to that the antenna port mapping is related, if a carrier aggregation is enabled ([Activate Carrier Aggregation](#) = On and [Activate CA](#) = On).

Remote command:

`[:SOURCE<hw>] :BB:EUTRa:DL:USER<ch>:APM:CELL` on page 729

Mapping Coordinates ← User-Specific Antenna Port Mapping

Switches between the "Cartesian (Real/Imag)" and "Cylindrical (Magn./Phase)" coordinates representation.

Remote command:

`[:SOURCE<hw>] :BB:EUTRa:DL:USER<ch>:APM:MAPCoordinates` on page 730

Mapping table ← User-Specific Antenna Port Mapping

Defines the mapping of the antenna ports (AP) to the physical antennas, see also "[Mapping table](#)" on page 215.

You can set the precoding matrix per layer and not only of the most upper one that corresponds to the selected number of layers, but also for the layers underneath. The number of used layers is always lower or equal to the number of Tx antennas. Different layers can be assigned per subframe, therefore it is possible that the antenna port mapping changes on a per subframe basis.

Remote command:

```
[ :SOURce<hw> ] :BB:EUTRa:DL:USER<ch>:APM[:LAYer<user>]:AP<dir0>:
BB<st0>:REAL on page 731
```

```
[ :SOURce<hw> ] :BB:EUTRa:DL:USER<ch>:APM[:LAYer<user>]:AP<dir0>:
BB<st0>:IMAGinary on page 731
```

4.6 General UL settings

Access:

1. Select "General > Link Direction > Uplink (SC-FDMA)".
2. Select "General UL Settings"

This dialog allows configuring the EUTRA/LTE system for transmission direction uplink.

• UL carrier aggregation configuration	219
• Physical settings	225
• Cell-specific settings	229
• TDD frame structure settings	232
• Signals settings	233
• PRACH settings	237
• PUSCH structure	239
• PUCCH structure	240

4.6.1 UL carrier aggregation configuration



UL Carrier Aggregation is an LTE-A (LTE Rel. 11) feature. It requires options R&S SMM-K55 and R&S SMM-K112.

Access:

1. Select "Baseband > EUTRA/LTE > General > Link Direction > Uplink (SC-FDMA)".

2. Select "General UL Settings > CA".

Cell Index	Phys. Cell ID	Bandwidth	Δf /MHz	Duplexing	UL/DL Config	Special SF Config	n(1)_DMRS	SRS SF Config	SRS BW C_SRS	Delay /ns	State
0	0	10 MHz	0.000 000	FDD	-	-	0	15	0	0	On
1	1	10 MHz	0.000 000	FDD	-	-	0	15	0	0	Off
2	2	10 MHz	0.000 000	FDD	-	-	0	15	0	0	Off
3	3	10 MHz	0.000 000	FDD	-	-	0	15	0	0	Off
4	4	10 MHz	0.000 000	FDD	-	-	0	15	0	0	Off

PCell (FDD)

U U U U U U U U U U

The dialog provides the settings for the configuration of one primary cell (PCell) and up to four secondary cells (SCell). The most important SCell settings are grouped in the "Carrier Aggregation" dialog.



The cell-specific parameters, like the PUCCH and PUSCH configuration, the DMRS and SRS transmission and the antenna port mapping are configurable in the [User equipment configuration](#) dialog of the corresponding UE.

4.6.1.1 About UL carrier aggregation

This section lists implementation-related information.

The following apply, if UL Carrier Aggregation is enabled:

- Combination of FDD and TDD is not possible.
- Component carriers are configured independent from each other. Their settings are calculated automatically from the PCell settings and form the parameters in the "UL Carrier Aggregation Configuration" dialog.
- Simultaneous support of LTE and LTE-A UEs is provided
- UE settings are configurable; they are however the same for each cell

Supported LTE-A bandwidth

The LTE specification defines a maximum [Channel Bandwidth](#) of 20MHz and aggregation of up to five component carriers to achieve 100MHz bandwidth.

For more information, see data sheet.

4.6.1.2 How to enable UL carrier aggregation



In the following, a general example is provided. Only the related settings are discussed.

To enable carrier aggregation and cross-carrier scheduling

1. Select "Baseband > EUTRA/LTE > General > Link Direction > Uplink (SC-FDMA)".
2. Select "General UL Settings > CA".

The "Activate Carrier Aggregation > On" parameter confirms that carrier aggregation is enabled automatically. Activated are two component carriers with 10 MHz bandwidth each.

3. Change the settings of the second component carrier.
See the example as shown in [Figure 4-11](#).

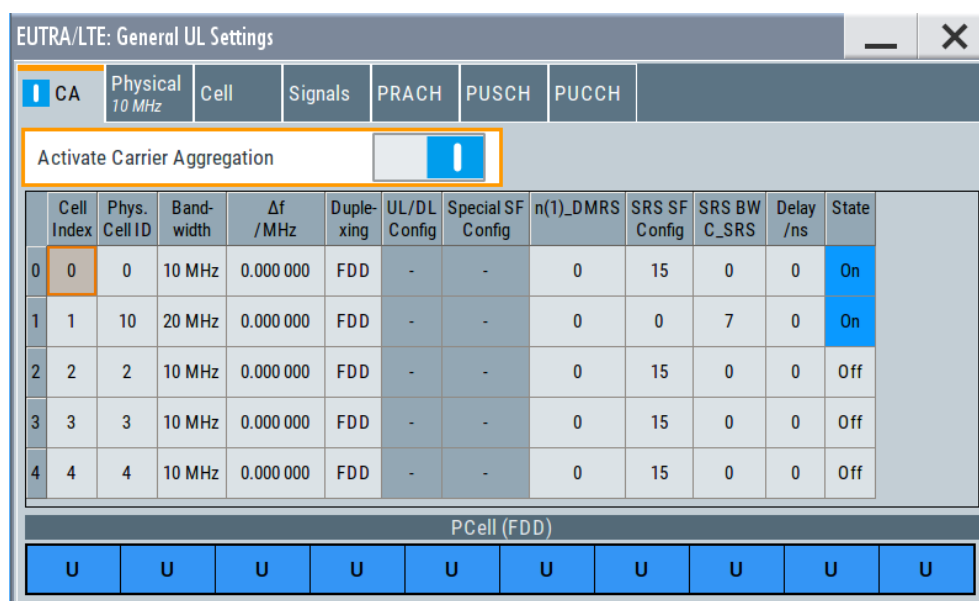
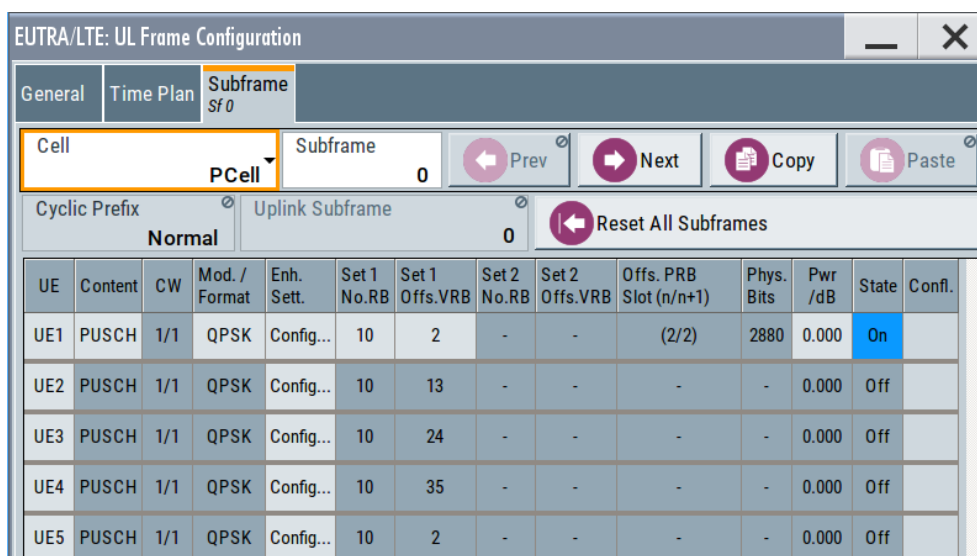
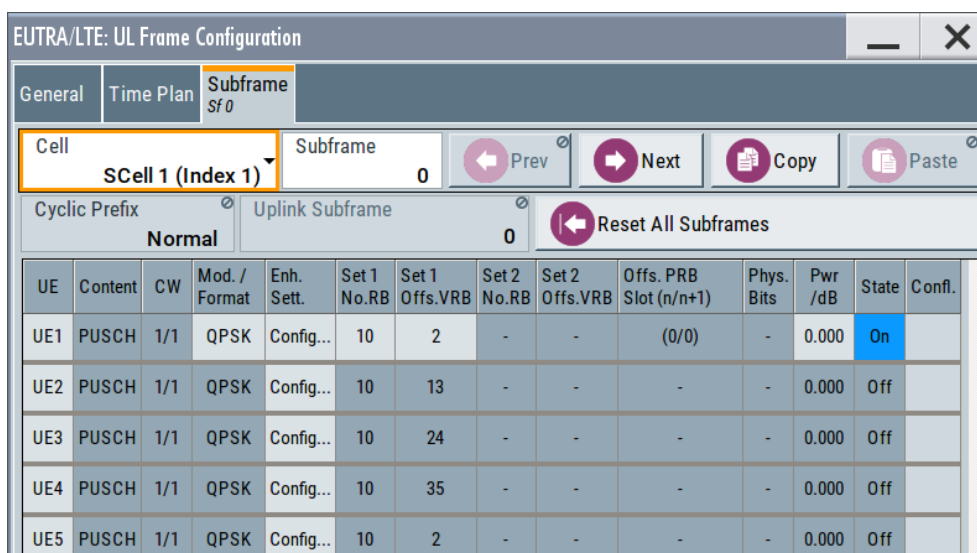

Figure 4-11: Example settings of "Carrier Aggregation"

4. Select "UL Frame Configuration > Subframe".
The settings of the primary cell (PCell) and the currently activated SCells can be configured individually.



Secondary cells are identified by their "Cell Index". This example uses one SCell that with "Index = 1".



Note: There is no PUCCH transmission on the SCells.

5. Select "UL Frame Configuration > Time Plan" to observe the configuration. Toggle between the time plan of the PCell and the SCell.

The time plan confirms that the component carriers use different bandwidths and the PUCCH is transmitted only on the PCell.

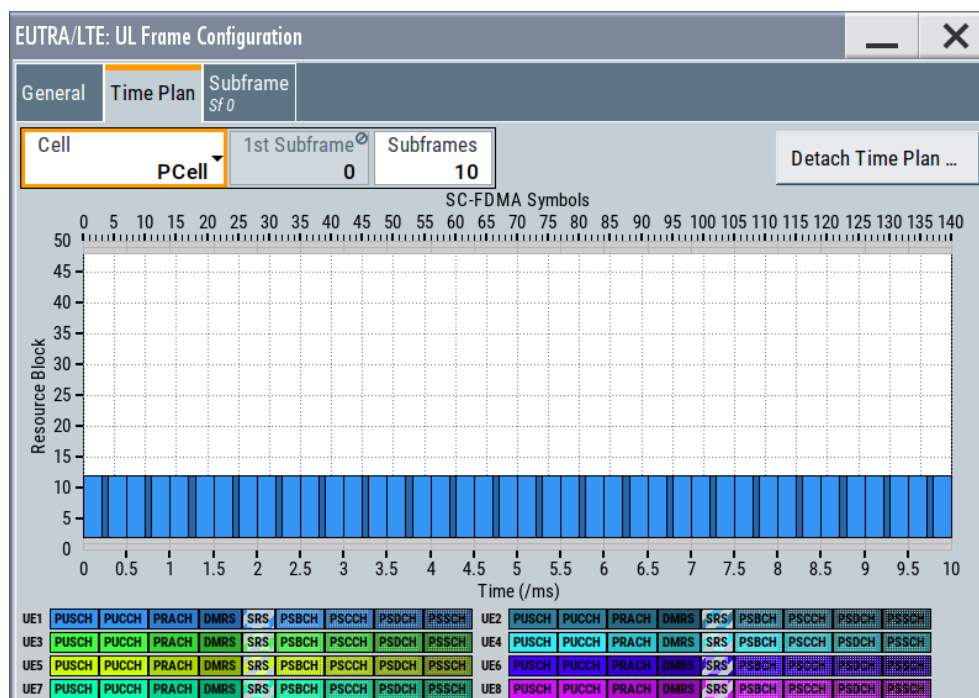

Further displayed information depends on the current configuration, e.g. activated SRS transmission, etc.

6. Select "EUTRA/LTE State > ON".
7. Activate the RF output.

4.6.1.3 Carrier aggregation settings

The cell-specific parameters, like the PUCCH and PUSCH configuration, the DMRS and SRS transmission and the antenna port mapping, are configurable in the [User equipment configuration](#) dialog.

Settings

- [Activate Carrier Aggregation](#)..... 224
- [Component Carrier Table](#)..... 224
 - [L Cell Index](#)..... 224
 - [L Physical Cell ID](#)..... 224
 - [L Bandwidth](#)..... 224
 - [L delta f / MHz](#)..... 224
 - [L Duplexing](#)..... 224
 - [L TDD UL/DL Configuration](#)..... 224
 - [L TDD Special Subframe Config](#)..... 225
 - [L n\(1\)_DMRS](#)..... 225
 - [L SRS Subframe Configuration](#)..... 225
 - [L SRS Bandwidth Configuration C_SRS](#)..... 225
 - [L Delay / ns](#)..... 225
 - [L State](#)..... 225

Activate Carrier Aggregation

Enables/disables the generation of several component carriers.

Remote command:

[:SOURCE<hw>] :BB:EUTRa:UL:CA:STATe on page 707

Component Carrier Table

The table provides the settings of the component carriers.

The first row displays the settings of the PCell as configured in the [General UL settings](#) dialog.

The following four rows provide the configurable settings of the up to four SCells.

Cell Index ← Component Carrier Table

Sets the cell index of the corresponding SCell.

The cell index of the PCell is always 0.

Remote command:

[:SOURCE<hw>] :BB:EUTRa:UL:CA:CELL<ch0>:INDEX on page 707

Physical Cell ID ← Component Carrier Table

Sets the physical Cell ID of the corresponding component carrier.

The value of the parameter "General UL Settings" > [Cell ID](#) is set automatically to the physical cell ID of the PCell.

Remote command:

[:SOURCE<hw>] :BB:EUTRa:UL:CA:CELL<ch0>:ID on page 707

Bandwidth ← Component Carrier Table

Sets the bandwidth of the corresponding component carrier.

Remote command:

[:SOURCE<hw>] :BB:EUTRa:UL:CA:CELL<ch0>:BW on page 708

delta f / MHz ← Component Carrier Table

Sets the frequency offset between the central frequency of corresponding SCell and the frequency of the PCell.

Remote command:

[:SOURCE<hw>] :BB:EUTRa:UL:CA:CELL<ch0>:DFReq on page 708

Duplexing ← Component Carrier Table

Selects the duplexing mode of the PCell. The duplexing mode of the SCells is set accordingly.

Combination of FDD and TDD requires option R&S SMM-K113.

Remote command:

[:SOURCE<hw>] :BB:EUTRa:UL:CA:CELL<ch0>:DUPLexing on page 708

TDD UL/DL Configuration ← Component Carrier Table

Sets the uplink-downlink configuration number. That is, defines which subframe is used for downlink respectively uplink, and where the special subframes are located.

The individual carriers can use different "UL/DL Configuration". The frame configuration of the selected carriers and the used duplexing are also displayed. Alternatively, use the [SC-FDMA time plan](#) to visualize them.

Remote command:

`[:SOURCE<hw>] :BB:EUTRa:UL:CA:CELL<ch0>:UDConf` on page 708

TDD Special Subframe Config ← Component Carrier Table

Sets the special subframe configuration number.

Together with the parameter [Cyclic Prefix](#), this parameter defines the lengths of the DwPTS, the guard period GP and the UpPTS.

Remote command:

`[:SOURCE<hw>] :BB:EUTRa:UL:CA:CELL<ch0>:SPSConf` on page 709

n(1)_DMRS ← Component Carrier Table

Sets the part of the demodulation reference signal (DMRS) index used by the calculation of the DMRS sequence, transmitted by the PCell/SCell.

Remote command:

`[:SOURCE<hw>] :BB:EUTRa:UL:CA:CELL<ch0>:DMRS` on page 709

SRS Subframe Configuration ← Component Carrier Table

Sets the cell-specific parameter SRS subframe configuration of the PCell/SCell.

Remote command:

`[:SOURCE<hw>] :BB:EUTRa:UL:CA:CELL<ch0>:SUConfiguration` on page 709

SRS Bandwidth Configuration C_SRS ← Component Carrier Table

Sets the cell-specific parameter SRS Bandwidth Configuration (C_{SRS}) of the PCell/SCell.

Remote command:

`[:SOURCE<hw>] :BB:EUTRa:UL:CA:CELL<ch0>:CSRS` on page 709

Delay / ns ← Component Carrier Table

Sets the time delay of the SCell relative to the PCell.

Remote command:

`[:SOURCE<hw>] :BB:EUTRa:UL:CA:CELL<ch0>:TDElay` on page 710

State ← Component Carrier Table

Activates/deactivates the component carrier.

Remote command:

`[:SOURCE<hw>] :BB:EUTRa:UL:CA:CELL<ch0>:STATE` on page 710

4.6.2 Physical settings

Access:

1. Select "General > Link Direction > Uplink (SC-FDMA)".

2. Select "General UL Settings > Physical"

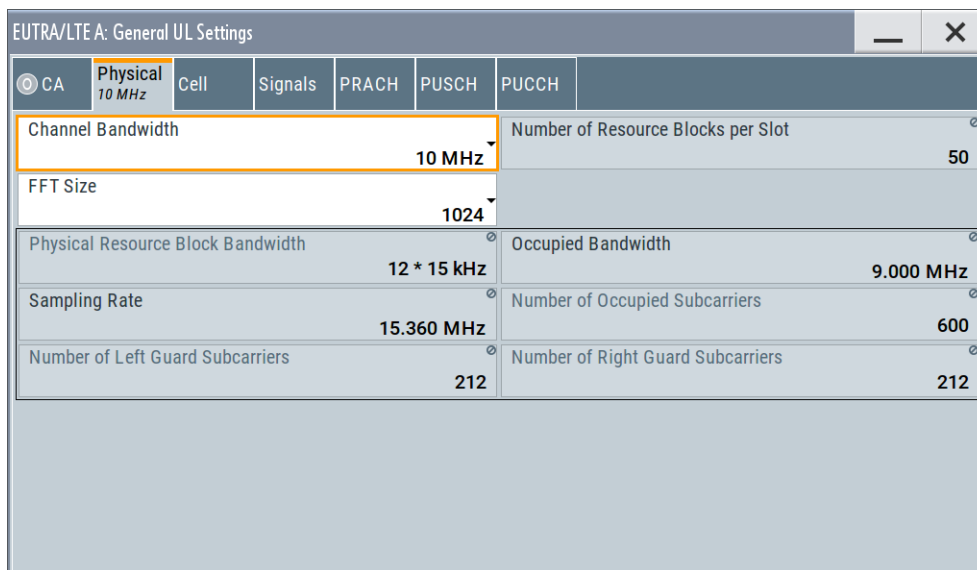

This dialog comprises the physical settings for uplink.

Settings:

Channel Bandwidth.....226

Number of Resource Blocks Per Slot.....227

FFT Size.....227

Number of eMTC Narrowbands.....227

Number of eMTC Widebands.....228

Wideband Config.....228

Physical Resource Block Bandwidth.....228

Occupied Bandwidth.....228

Sampling Rate.....228

Number Of Occupied Subcarriers.....229

Number of Left/Right Guard Subcarriers.....229

Channel Bandwidth

Sets the channel bandwidth of the EUTRA/LTE system.

The 3GPP specification defines bandwidth agnostic layer 1 where the channel bandwidth is determined by specifying the desired number of resource blocks. However, the current EUTRA standardization focuses on six bandwidths.

- "1.4 MHz, 3 MHz, 5 MHz, 10 MHz, 15 MHz, 20 MHz"
 Select a predefined channel bandwidth.
 The parameter "Number of Resource Blocks Per Slot" is internally calculated for the selected "Channel Bandwidth" and "Physical Resource Block Bandwidth".
 The sampling rate, occupied bandwidth and FFT size are therefore determined by the parameter "Number of Resource Blocks Per Slot". If necessary, adjust the "FFT Size".
 See also [Table 2-1](#) for an overview of the cross-reference between the parameters.

If "Mode > eMTC/NB-LoT or LTE/eMTC/NB-LoT" is selected, the "1.4 MHz" bandwidth is supported by LTE and eMTC; the NB-LoT-specific settings are not available for configuration.

- "200 kHz"
Option: R&S SMM-K115
This channel bandwidth is **dedicated to NB-LoT**. It is available, if "Mode > eMTC/NB-LoT or LTE/eMTC/NB-LoT" is selected.
If channel bandwidth of 200 kHz is used, the LTE or eMTC-specific settings are not available for configuration. Available is only one NB-LoT carrier which works in standalone mode (Mode = "Standalone").
- "User"
Option: R&S SMM-K55
Provided for backward compatibility with previous version of this software, this parameter allows you to select a user-defined bandwidth as number of resource blocks.

Remote command:

[:SOURce<hw>] :BB:EUTRa:UL:BW on page 593

Number of Resource Blocks Per Slot

Indicates the number of used resource blocks for the selected "Channel Bandwidth".

"Channel Bandwidth"	"Number of Resource Blocks Per Slot (UL)"
"1.4 MHz, 3 MHz, 5 MHz, 10 MHz, 15 MHz, 20 MHz"	Read-only value, set automatically as function of the "Channel Bandwidth" and "Physical Resource Block Bandwidth"
"User"	"Channel Bandwidth" depends on the "Number of Resource Blocks Per Slot" and "Physical Resource Blocks Bandwidth"

The sampling rate and the occupied bandwidth are determined by the parameter "Number of Resource Blocks Per Slot". If necessary, adjust the value of [FFT Size](#).

See also [Table 2-1](#).

Remote command:

[:SOURce<hw>] :BB:EUTRa:UL:NORB on page 593

FFT Size

Sets the FFT (Fast Fourier Transformation) size. The available values depend on the selected "Number of Resource Blocks Per Slot".

Remote command:

[:SOURce<hw>] :BB:EUTRa:UL:FFT on page 594

Number of eMTC Narrowbands

Option: R&S SMM-K115

This parameter is **dedicated to eMTC** and available if "Mode > eMTC/NB-LoT or LTE/eMTC/NB-LoT" is selected.

It indicates the number of eMTC narrowbands N_{NB} available within the selected channel bandwidth.

The value is calculated as follows:

"Number of Narrowbands" = "Number of Resource Blocks" / 6

For more information, see "[Narrowbands](#)" on page 332.

Remote command:

[:SOURce<hw>] :BB:EUTRa:UL:EMTC:NNBands? on page 893

Number of eMTC Widebands

Option: R&S SMM-K143

This parameter is **dedicated to eMTC** and available if "Mode > eMTC/NB-LoT or LTE/eMTC/NB-LoT" and [Wideband Config](#) > "On" is selected.

It indicates the number of eMTC widebands N_{WB} available within the selected channel bandwidth.

The value is calculated as follows:

"Number of Widebands" = [Number of eMTC Narrowbands](#) / 4

For more information, see "[Widebands](#)" on page 333.

Remote command:

[:SOURce<hw>] :BB:EUTRa:UL:EMTC:NWBands? on page 894

Wideband Config

Option: R&S SMM-K143

This parameter is **dedicated to eMTC** and available if "Mode > eMTC/NB-LoT or LTE/eMTC/NB-LoT" is selected.

If enabled, the available channel bandwidth is split into eMTC widebands, where the resulting number of widebands is indicated by the parameter "[Number of eMTC Widebands](#)" on page 228.

For more information, see "[Widebands](#)" on page 333.

Remote command:

[:SOURce<hw>] :BB:EUTRa:UL:EMTC:WBCFg on page 894

Physical Resource Block Bandwidth

Displays the bandwidth of one physical resource block.

Note: In this release, this value is fixed to 12 x 15 kHz.

Remote command:

n.a.

Occupied Bandwidth

Displays the occupied bandwidth, calculated from the parameter "Number of Resource Blocks Per Slot".

Remote command:

[:SOURce<hw>] :BB:EUTRa:UL:OCCBandwidth? on page 594

Sampling Rate

Displays the sampling rate, calculated from the parameter "Number of Resource Blocks Per Slot".

Remote command:

[:SOURce<hw>] :BB:EUTRa:UL:SRATe? on page 593

Number Of Occupied Subcarriers

Displays the number of occupied subcarriers, calculated from the parameter "Number of Resource Blocks Per Slot".

Remote command:

[:SOURce<hw>] :BB:EUTRa:UL:OCCSubcarriers? on page 594

Number of Left/Right Guard Subcarriers

Displays the number of left/right guard subcarriers, calculated from the parameter "Number of Resource Blocks Per Slot".

Remote command:

[:SOURce<hw>] :BB:EUTRa:UL:LGS? on page 594

[:SOURce<hw>] :BB:EUTRa:UL:RGS? on page 595

4.6.3 Cell-specific settings

Access:

1. Select "General > Link Direction > Uplink (SC-FDMA)".
2. Select "General UL Settings > Cell"

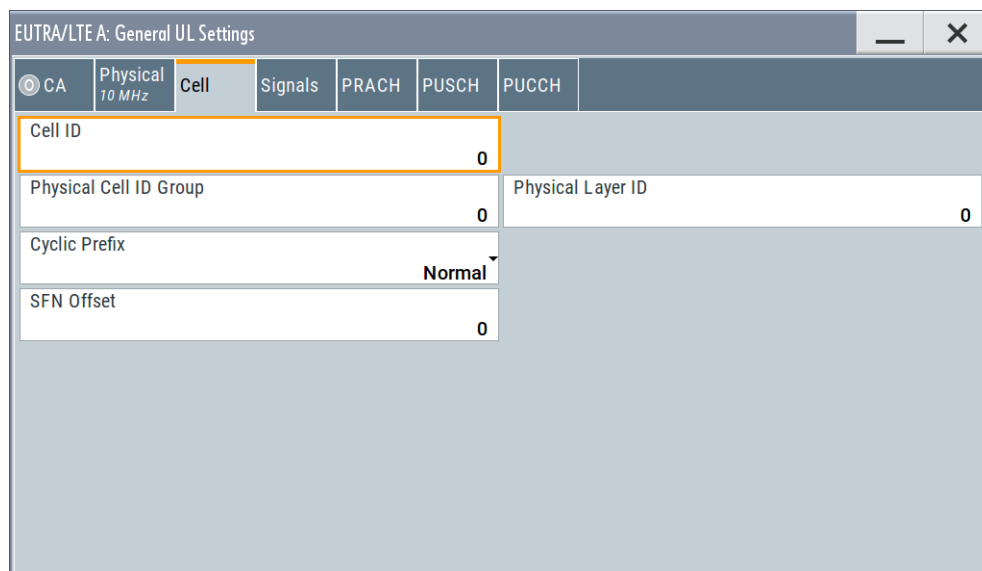

This dialog comprises the settings needed for configuring the physical layer cell ID settings, the UL Reference Signal settings, the PUSCH, PUCCH and PRACH structures are selected, as well as cell-specific SRS parameters.

Provided are the following settings:

Cell ID.....	230
Physical Cell ID Group.....	230
Physical Layer ID.....	230
Cyclic Prefix.....	230
SFN Offset.....	231
UL/DL Cyclic Prefix.....	232
eMTC Parameters.....	232
L Retuning Symbols.....	232
L Valid Subframes.....	232

Cell ID

Sets the cell identity.

There are 504 unique physical layer cell identities (cell ID), grouped into 168 unique physical cell identity groups that contain three unique identities each. The cell ID is calculated as following:

$$\text{Cell ID} = 3 * \text{Physical Cell ID Group} + \text{Physical Layer ID}$$

There is a cross-reference between the values of these three parameters and changing of one of them results in adjustment in the values of the others.

The cell ID determinates:

- The reference signal grouping hopping pattern
- The reference signal sequence hopping
- The PUSCH demodulation reference signal pseudo-random sequence
- The cyclic shifts and scrambling sequences for all PUCCH formats
- The pseudo-random sequence used for scrambling
- The pseudo-random sequence used for type 2 PUSCH frequency hopping.

Remote command:

[:SOURCE<hw>] :BB:EUTRa:UL [:PLCI] :CID on page 595

Physical Cell ID Group

Sets the ID of the physical cell identity group.

To configure these identities, set the parameter [Physical Layer ID](#).

The physical layer cell identities determine the sequence shift pattern used for PUCCH.

Remote command:

[:SOURCE<hw>] :BB:EUTRa:UL [:PLCI] :CIDGroup on page 595

Physical Layer ID

Sets the identity of the physical layer within the selected physical cell identity group, set with parameter [Physical Cell ID Group](#).

Remote command:

[:SOURCE<hw>] :BB:EUTRa:UL [:PLCI] :PLID on page 596

Cyclic Prefix

Sets the cyclic prefix length for all subframes.

The number of the SC-FDMA symbols is set automatically.

"Normal" Normal cyclic prefix, i.e. the UL slot contains 7 SC-FDMA symbols.

- "Extended" Extended cyclic prefix, i.e. the UL slot contains 6 SC-FDMA symbols. The extended cyclic prefix is defined in order to cover large cell scenarios with higher delay spread and MBMS transmission. NB-IoT allocations cannot be activated.
- "User Defined" If **Mode** = LTE, the cyclic prefix length can vary over the subframes. Set the cyclic prefix length per subframe with the parameter "UL Frame Configuration" > "Cyclic Prefix."

Remote command:

[:SOURce<hw>] :BB:EUTRa:UL:CPC on page 596

SFN Offset

By default, the counting of the SFN (System Frame Number) starts with 0. Use this parameter to set a different start SFN value, e.g. to skip a defined number of frames.

Example: Visualizing the SFN offset in the SC-FDMA time plan

Perform the following:

- Select "EUTRA/LTE > General > Standard > LTE"
- Select "EUTRA/LTE > General > Filter/Clipping/ARB ...".
- Select "ARB > Sequence Length = 100 Frames".
- Select "General > Link Direction > Uplink (SC-FDMA)".
- Select "General > General Settings > Cell > SFN Offset = 1".
- Select "General > Frame Configuration > No. of PUCCH Config = No. PUSCH Config. = 40".
- Select "Frame Configuration > Subframe#0 > PUSCH > No. of RB = 50".
- Select "Frame Configuration > Time Plan" and set "Subframes = 20".

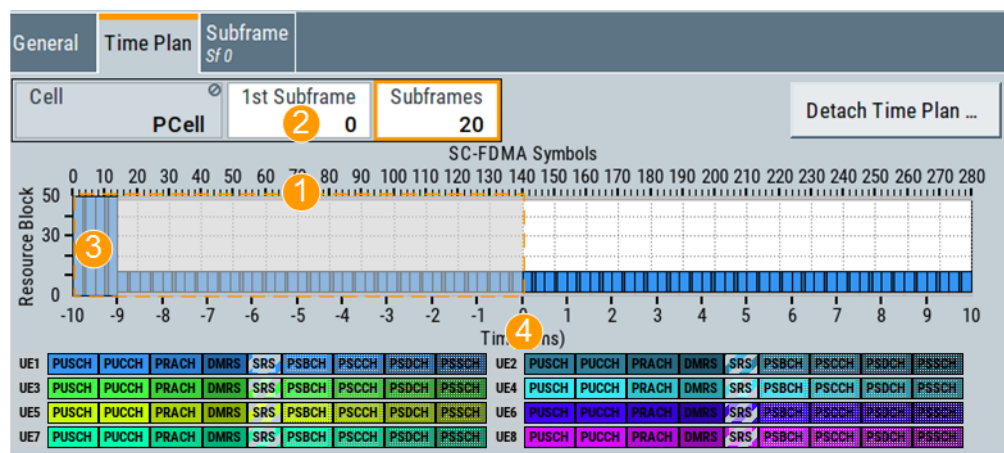

Figure 4-12: Visualization of an enabled SFN offset in the time plan

- 1 = SFN offset = 1 Frame = 10 Subframes
 2 = First (most left) displayed subframe is Subframe#0; 20 subframes = 2 frames are displayed
 3 = PUCCH with "No. of RB = 50" as configured in the Subframe#0
 4 = First 1 frame is skipped; generation starts with the second frame

Remote command:

[:SOURce<hw>] :BB:EUTRa:UL:SOFFset on page 596

UL/DL Cyclic Prefix

In "Duplexing > TDD", determines the cyclic prefix for the appropriate opposite direction.

Remote command:

[:SOURCE<hw>] :BB:EUTRa:UL:DLCPc on page 596

[:SOURCE<hw>] :BB:EUTRa:DL:ULCPc on page 588

eMTC Parameters

Comprises cell-specific parameters, dedicated to eMTC.

Retuning Symbols ← eMTC Parameters

Option: R&S SMM-K143

This parameter is **dedicated to eMTC** and available if "Mode > eMTC/NB-IoT or LTE/eMTC/NB-IoT" is selected.

It sets the number of symbols used for the transmission between the eMTC narrowbands or widebands.

For details, see "[Guard period for narrowband and wideband retuning](#)" on page 331.

Remote command:

[:SOURCE<hw>] :BB:EUTRa:UL:EMTC:RSYMBOL on page 894

Valid Subframes ← eMTC Parameters

Option: R&S SMM-K115

This parameter is **dedicated to eMTC** and available if "Mode > eMTC/NB-IoT or LTE/eMTC/NB-IoT" is selected.

It indicates that a subframe (SF) is used for eMTC transmission. If an SF is set to invalid, the eMTC transmission is postponed during this SF.

The selected subframes influence the scheduling of the eMTC transmissions (see [Start Subframe](#)).

Remote command:

[:SOURCE<hw>] :BB:EUTRa:UL:EMTC:VALID:SUBFRAME<dir> on page 895

4.6.4 TDD frame structure settings

Access:

- ▶ Select "EUTRA/LTE > Duplexing > TDD".

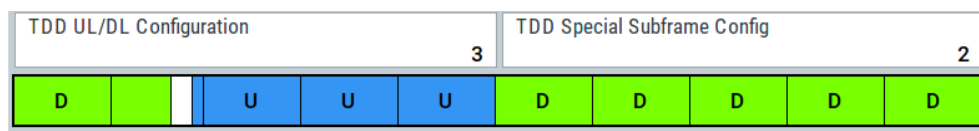

The TDD frame is configured by adjusting the UL/DL configuration and the special subframe configuration (see also [Chapter 2.2.1.1, "OFDMA parameterization"](#), on page 19).

TDD UL/DL Configuration

Sets the UL/DL configuration number and defines which subframe is used for downlink respectively uplink, and where the special subframes are located.

Remote command:

[:SOURCE<hw>] :BB:EUTRa:TDD:UDConf on page 579

TDD Special Subframe Config

Sets the special subframe configuration number and together with the parameter "Cyclic Prefix" defines the lengths of the DwPTS, the guard period (GP) and the UpPTS.

The DwPTS length selected with this parameter determines the maximum number of the OFDM symbols available for PDSCH in the special subframe.

The UpPTS length selected with this parameter determines the maximum number of the SC-FDMA symbols available for SRS in the special subframe.

Remote command:

[:SOURCE<hw>] :BB:EUTRa:TDD:SPSConf on page 578

Number of UpPTS Symbols

Option: R&S SMM-K119 (if "Mode = LTE")

Option: R&S SMM-K143 (if "Mode = eMTC/NB-IoT")

For [TDD Special Subframe Config](#) = 10, sets the number of UpPTS symbols.

In all other configurations, the number of UpPTS symbols is set automatically depending on:

- ["TDD UL/DL Configuration"](#) on page 100
- ["TDD Special Subframe Config"](#) on page 100.

Remote command:

[:SOURCE<hw>] :BB:EUTRa:TDD:UPTS on page 579

4.6.5 Signals settings

Access:

1. Select "General > Link Direction > Uplink (SC-FDMA)".
2. Select "General Settings > Signals"

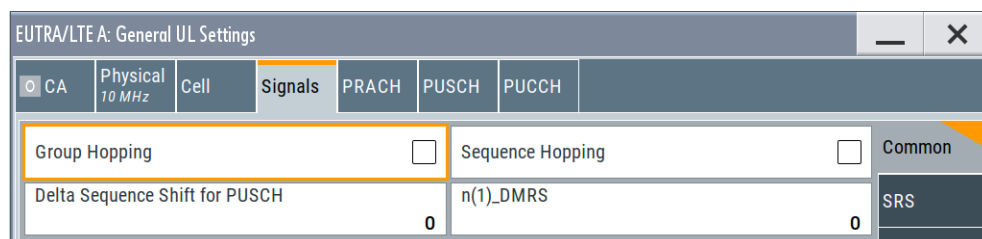

This dialog comprises the settings needed for configuring the uplink reference signals and the SRS structure.

4.6.5.1 UL reference signals

Access:

1. Select "LTE > Link Direction > Uplink".
2. Select "General Settings > Signals > Common".

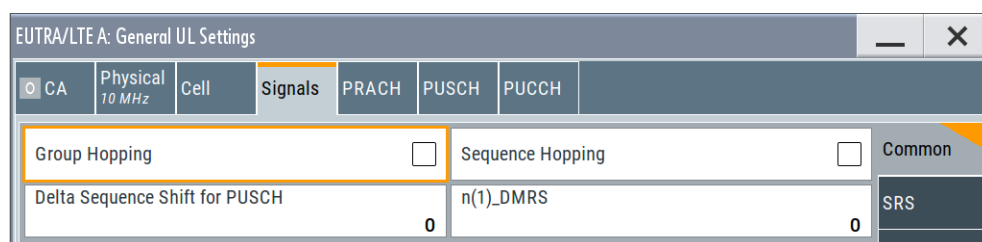

Settings:

Group Hopping	234
Sequence Hopping	234
Delta Sequence Shift for PUSCH	235
n(1)_DMRS	235

Group Hopping

Enables/disables group hopping for the uplink reference signals demodulation reference signal (DMRS) and sounding reference signal (SRS).

17 different hopping patterns and 30 different sequence shift patterns are used for group hopping.

PUSCH and PUCCH use **the same group hopping pattern** that is calculated if the "Group Hopping" is enabled. The group hopping pattern is generated by a pseudo-random sequence generator. The sequence shift patterns are derived as follows:

- PUCCH
From the physical layer cell ID set as a combination of the parameters [Physical Cell ID Group](#) and [Physical Layer ID](#).
- PUSCH
By the parameter [Delta Sequence Shift for PUSCH](#).

Remote command:

`[:SOURCE<hw>] :BB:EUTRa:UL:REFSig:GRPHopping` on page 597

Sequence Hopping

Enables/disables sequence hopping for the uplink reference signals demodulation reference signal (DMRS) and sounding reference signal (SRS).

If sequence hopping and [Group Hopping](#) are be activated simultaneously, only group hopping is applied as defined in [TS 36.211](#).

The sequence hopping is generated by a pseudo-random sequence generator.

Remote command:

`[:SOURCE<hw>] :BB:EUTRa:UL:REFSig:SEQHopping` on page 597

Delta Sequence Shift for PUSCH

Sets the delta sequence shift for PUSCH needed for the calculation of the group hopping pattern.

Remote command:

[:SOURCE<hw>] :BB:EUTRa:UL:REFSig:DSSHift on page 597

n(1)_DMRS

Sets the part of the demodulation reference signal (DMRS) index which is broadcasted and therefore valid for the whole cell. This index applies when multiple shifts within a cell are used. It is used for the calculation of the DMRS sequence.

Remote command:

[:SOURCE<hw>] :BB:EUTRa:UL:REFSig:DMRS on page 598

4.6.5.2 Cell-specific SRS settings

The cell-specific parameters in this section determine the structure of the sounding reference signal (SRS) according to the [TS 36.211](#).

Access:

1. Select "LTE > Link Direction > Uplink".
2. Select "General Settings > Signals > SRS"

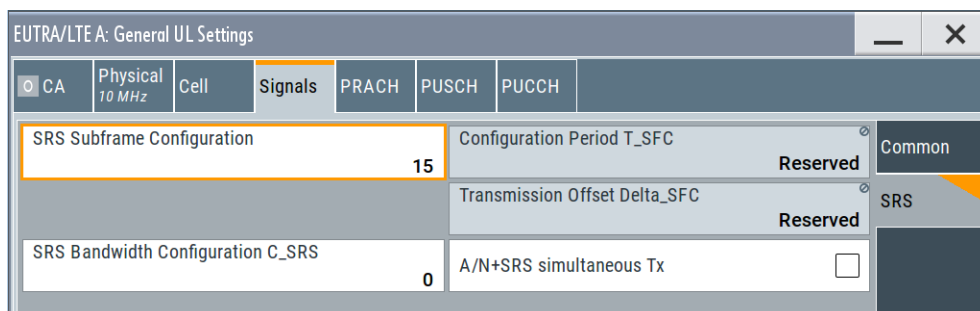

To configure the UE-specific parameters, necessary for the complete definition of the SRS structure and SRS mapping, use the settings in the "UEX > User Equipment > SRS" dialog.

See [Chapter 4.8.6, "Sounding reference signal \(SRS\)"](#), on page 268.

To enable an aperiodic SRS transmission, use the parameters:

- "DL Frame Configuration > Configure User" > [Aperiodic SRS State](#).
- "SRS Request" flag in the DCI formats "DL Frame Configuration > PDCCH > DCI Format > Config", for example [DCI Format 1A](#).
- SRS set parameters in the "User Equipment" > [Sounding reference signal \(SRS\)](#) dialog.

Settings:

[SRS Subframe Configuration](#).....236

[Configuration Period T_SFC](#).....236

[Transmission Offset Delta_SFC](#).....236

SRS Bandwidth Configuration C_SRS.....	236
A/N + SRS simultaneous Tx.....	236
SRS MaxUpPTS.....	236

SRS Subframe Configuration

Sets the cell-specific parameter SRS subframe configuration.

This parameter can also influence the shortening of PUCCH/PUSCH transmissions, regardless whether the UEs are configured to send an SRS in the subframe or not.

Remote command:

[:SOURCE<hw>] :BB:EUTRa:UL:REFSig:SRS:SUConfiguration on page 599

Configuration Period T_SFC

Displays the value for the cell-specific parameter configuration period T_{SFC} in subframes, depending on the selected "SRS Subframe Configuration" and the "Duplexing" mode.

Remote command:

[:SOURCE<hw>] :BB:EUTRa:UL:REFSig:SRS:TSFC? on page 599

Transmission Offset Delta_SFC

Displays the value for the cell-specific parameter transmission offset Δ_{SFC} in subframes, depending on the selected "SRS Subframe Configuration" and the "Duplexing" mode.

Remote command:

[:SOURCE<hw>] :BB:EUTRa:UL:REFSig:SRS:DSFC? on page 599

SRS Bandwidth Configuration C_SRS

Sets the cell-specific parameter SRS bandwidth configuration (C_{SRS}).

The SRS bandwidth configuration C_{SRS} , the [SRS Bandwidth B_SRS](#) and the "Channel Bandwidth" determine the length of the sounding reference signal sequence, calculated according to [TS 36.211](#).

Remote command:

[:SOURCE<hw>] :BB:EUTRa:UL:REFSig:SRS:CSRS on page 598

A/N + SRS simultaneous Tx

Enables/disables simultaneous transmission of SRS (sounding reference signal) and ACK/NACK messages, i.e. transmission of SRS and PUCCH in the same subframe.

Simultaneous transmission of SRS and PUCCH is allowed only for PUCCH formats 1, 1a, 1b and 3, since CQI reports are never simultaneously transmitted with SRS.

If this parameter is disabled, the SRS is not transmitted in the corresponding subframe.

Remote command:

[:SOURCE<hw>] :BB:EUTRa:UL:REFSig:SRS:ANSTx on page 598

SRS MaxUpPTS

In TDD duplexing mode, enables the cell-specific parameter `srsMaxUpPts`.

If enabled, an SRS is transmitted in the frequency area of the UpPTS field that does not overlap with the frequency resources reserved for a possible PRACH preamble format 4 transmission.

This is done by reconfiguring the number of SRS resource blocks in the special sub-frames, which would otherwise be determined by C_SRS and B_SRS.

Remote command:

[:SOURCE<hw>] :BB:EUTRa:UL:REFSig:SRS:MUPTs on page 598

4.6.6 PRACH settings

Access:

1. Select "General > Link Direction > Uplink (SC-FDMA)".
2. Select "General UL Settings > PRACH".

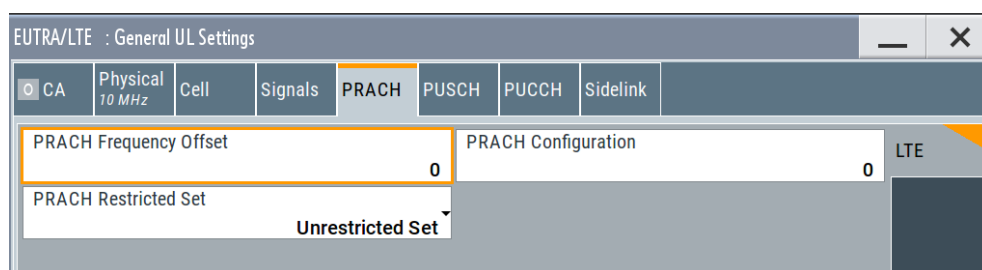

This dialog comprises the cell-specific parameters that determine the PRACH configuration according to the TS 36.211.

The UE-specific parameters, necessary for the complete definition of the PRACH, are configurable in the [User Equipment Configuration](#) dialog of the corresponding UE.

PRACH Frequency Offset	237
PRACH Configuration	237
PRACH Restricted Set	239

PRACH Frequency Offset

For preamble formats 0 to 3, sets the prach-FrequencyOffset $n_{PRBOffset}^{RA}$ as defined in the TS 36.211, i.e. determines the first physical resource block available for PRACH expressed as a physical resource block number that fulfills the equation:

$$0 \leq n_{PRBOffset}^{RA} \leq \text{Number of Resource Blocks Per Slot} - 6$$

Remote command:

[:SOURCE<hw>] :BB:EUTRa:UL:PRACH:FOFFset on page 600

PRACH Configuration

Sets the PRACH configuration index as defined in the TS 36.211. PRACH configuration defines the time and frequency resources in which random access preamble transmission is allowed.

The PRACH allocation occupies a bandwidth of 6 RBs.

The PRACH distribution (subframe, length, offset) depends on several other parameters:

- Selected "Cyclic Prefix"
- Selected [PRACH Frequency Offset](#)
- Selected frame format, i.e. on the selected "Duplexing Mode" mode
- Selected [Frequency Resource Index](#) (for TDD mode).

Not all combinations of channel bandwidth, PRACH configuration and PRACH frequency offset are allowed.

The table below gives an overview on the dependency of the value range of the parameter "PRACH Configuration" and other parameters.

Duplexing Mode	TDD Special Subframe Config	(Global) Cyclic Prefix	PRACH Configuration
FDD	-	Normal/Extended	0 to 63
TDD	0 to 3	Normal/Extended	0 to 47
	4	Normal	0 to 47
	4	Extended	0 to 57
	5 to 8	Normal/Extended	0 to 57

The [Preamble Format](#) is automatically derived from the "PRACH Configuration".

Use the SC-FDMA Time plan to display the PRACH distribution.

Example:

PRACH example configuration:

- "Duplexing Mode = FDD"
- "General UL Settings > Cell > Cyclic Prefix = Normal"
- "General UL Settings > Physical > Channel Bandwidth = 3 MHz"
- "General UL Settings > PRACH > PRACH Frequency Offset = 5"
- "PRACH Configuration = 55"
(Preamble Format = 3)
- Adjusted the PRACH frequency offset

Observe the timeplan.

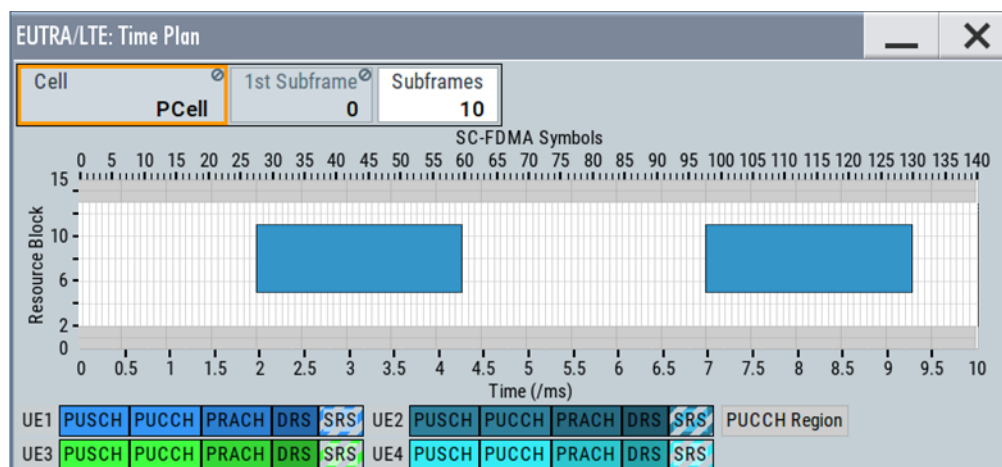

Remote command:

[:SOURCE<hw>] :BB:EUTRa:UL:PRACH:CONFIguration on page 600

PRACH Restricted Set

Selects whether a restricted preamble set ("Type A" or "Type B") or the unrestricted preamble set (normal mode) will be used.

Remote command:

[:SOURCE<hw>] :BB:EUTRa:UL:PRACH:RSET on page 600

4.6.7 PUSCH structure

1. To access this dialog, select "General > Link Direction > Uplink (SC-FDMA)".
2. Select "General UL Settings > PUSCH".

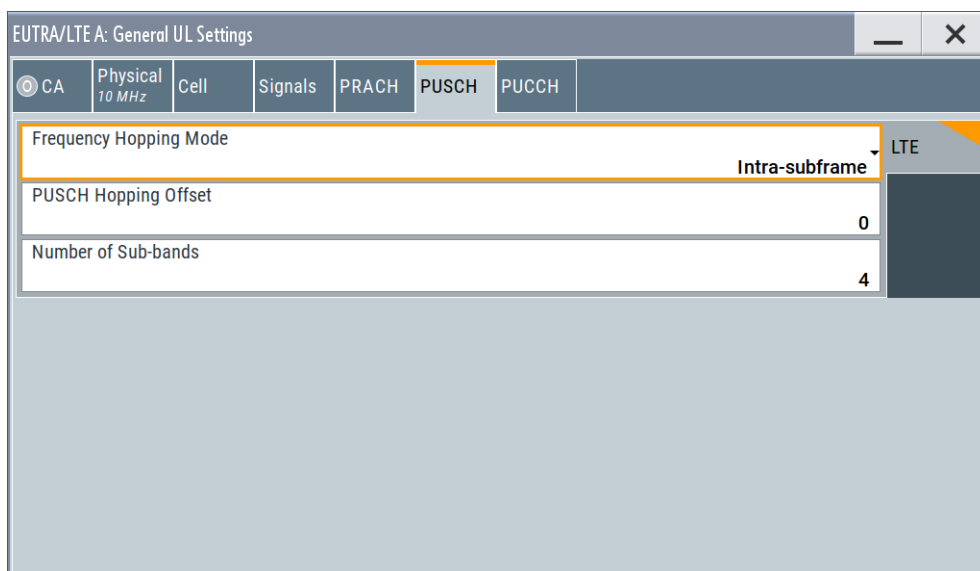

Provided are the following settings:

Frequency Hopping Mode.....	239
PUSCH Hopping Offset.....	240
Number of Sub-bands.....	240

Frequency Hopping Mode

Sets the frequency hopping mode for PUSCH.

Frequency hopping is applied according to [TS 36.213](#).

"Inter-sub-frame"	The PUSCH position in terms of used resource blocks is changed each subframe.
"Intra-sub-frame"	Both intra- and inter-subframe hopping are performed. The PUSCH position in terms of used resource blocks is changed each slot and each subframe.

Remote command:

[:SOURce<hw>] :BB:EUTRa:UL:PUSCh:FHMode on page 600

PUSCH Hopping Offset

Sets the PUSCH Hopping Offset N_{RB}^{HO} .

The PUSCH Hopping Offset determines the first physical resource block and the maximum number of physical resource blocks available for PUSCH transmission if PUSCH frequency hopping is used.

Remote command:

[:SOURce<hw>] :BB:EUTRa:UL:PUSCh:FHOFFset on page 601

Number of Sub-bands

Sets the number of sub-bands (N_{sb}) into that the total range of physical resource blocks available for PUSCH transmission is divided. The frequency hopping is performed at sub-band level.

The size of one sub-band is determined by the number of resource blocks available for PUSCH transmission, the "Number of Sub-bands" and the PUSCH hopping parameters.

Remote command:

[:SOURce<hw>] :BB:EUTRa:UL:PUSCh:NOSM on page 601

4.6.8 PUCCH structure

Access:

1. Select "General > Link Direction > Uplink (SC-FDMA)".
2. Select "General UL Settings > PUCCH".

EUTRA/LTE A: General UL Settings								
CA	Physical 10 MHz	Cell	Signals	PRACH	PUSCH	PUCCH		
Number of RBs used for PUCCH						4	Delta Shift	2
N(1)_cs						6	N(2)_RB	1
Range n(1)_PUCCH (Normal CP)						0...44	Range n(1)_PUCCH (Extended CP)	0...29
Range n(2)_PUCCH						0...15	Range n(3)_PUCCH	0...19
Range n(4)_PUCCH						0...1	Range n(5)_PUCCH	0...3

Settings:

Number of RBs used for PUCCH.....241
 Delta Shift.....241
 N(1)_cs.....242
 N(2)_RB.....242
 Range n(1)_PUCCH (Normal/Extended CP).....242
 Range n(2)_PUCCH.....242
 Range n(3)_PUCCH.....242
 Range n(4)_PUCCH/Range n(5)_PUCCH.....243

Number of RBs used for PUCCH

Sets the PUCCH region in terms of reserved resource blocks, at the edges of the channel bandwidth (see Figure 2-18).

The PUCCH region is displayed on the time plan.

Example:

- "Physical > Channel Bandwidth = 3 MHz"
- "General UL Settings > PUCCH > Number of RBs used for PUCCH = 3"
- "UL Frame Configuration > PUCCH > Format = 2a" and "PUCCH State > On"

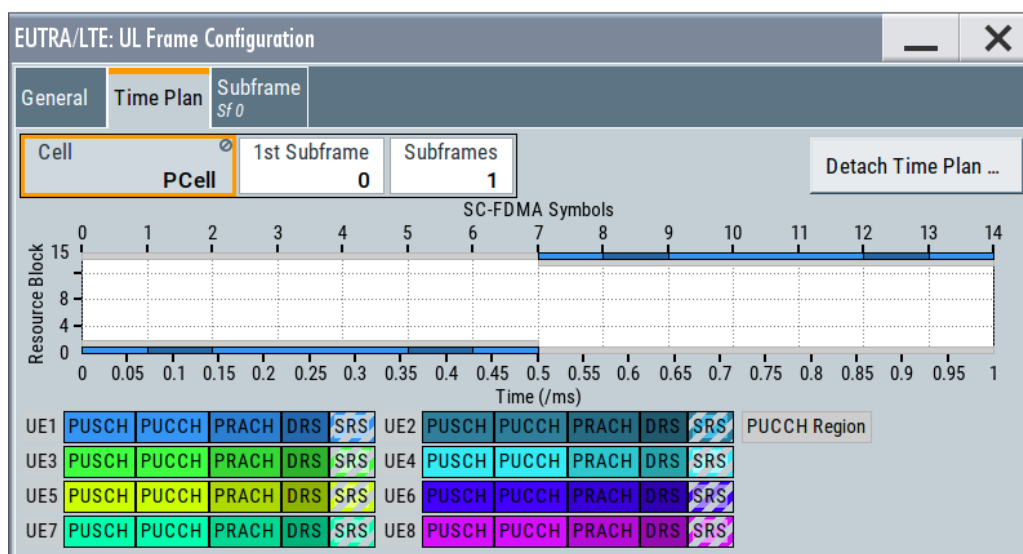

Figure 4-13: Example: Representation of subframe with PUCCH region with three reserved resource blocks on the time plan

Remote command:

```
[ :SOURce<hw> ] :BB:EUTRa:UL:PUCCh:NORB on page 601
```

Delta Shift

Sets the delta shift parameter, i.e. the cyclic shift difference between two adjacent PUCCH resource indices with the same orthogonal cover sequence (OC).

The delta shift determinates the number of available sequences in a resource block that can be used for PUCCH formats 1/1a/1b (see also Table 2-5).

Remote command:

[:SOURCE<hw>] :BB:EUTRa:UL:PUCCh:DESHift on page 602

N(1)_cs

Sets the number of cyclic shifts used for PUCCH format 1/1a/1b in a resource block used for a combination of the formats 1/1a/1b and 2/2a/2b.

Only one resource block per slot can support a combination of the PUCCH formats 1/1a/1b and 2/2a/2b.

The number of cyclic shifts available for PUCCH format 2/2a/2b N(2)_cs in a block with combination of PUCCH formats is calculated as follows:

$$N(2)_cs = 12 - N(1)_cs - 2$$

Remote command:

[:SOURCE<hw>] :BB:EUTRa:UL:PUCCh:N1CS on page 602

N(2)_RB

Sets bandwidth in terms of resource blocks that are reserved for PUCCH formats 2/2a/2b transmission in each subframe.

There can be only one resource block per slot that supports a combination of the PUCCH formats 1/1a/1b and 2/2a/2b. Hence, the number of RBs per slot available for PUCCH format 1/1a/1b is determinate by "N(2)_RB".

Remote command:

[:SOURCE<hw>] :BB:EUTRa:UL:PUCCh:N2RB on page 602

Range n(1)_PUCCH (Normal/Extended CP)

Displays the range of the possible PUCCH format 1/1a/1b transmissions from different UEs in one subframe and per cyclic prefix.

Insufficient ranges are displayed as '-'.

The parameter "Range n(1)_PUCCH (Normal CP)" determines the value range of the index "n_PUCCH" for PUCCH format 1/1a/1b.

See [n_PUCCH](#)

Remote command:

[:SOURCE<hw>] :BB:EUTRa:UL:PUCCh:N1NMax? on page 603

[:SOURCE<hw>] :BB:EUTRa:UL:PUCCh:N1EMax? on page 603

Range n(2)_PUCCH

Displays the range of possible number of PUCCH format 2/2a/2b transmissions from different UEs in one subframe.

Insufficient ranges are displayed as '-'.

Remote command:

[:SOURCE<hw>] :BB:EUTRa:UL:PUCCh:N2Max? on page 603

Range n(3)_PUCCH

Displays the range of possible number of PUCCH format 3 transmissions from different UEs in one subframe.

Insufficient ranges are displayed as '-'.

Remote command:

[:SOURCE<hw>] :BB:EUTRa:UL:PUCCh:N3Max? on page 604

Range n(4)_PUCCH/Range n(5)_PUCCH

Option: R&S SMM-K119

Displays the range of possible number of PUCCH format 4 and 5 transmissions from different UEs in one subframe.

Insufficient ranges are displayed as '-!.

Remote command:

[:SOURCE<hw>] :BB:EUTRa:UL:PUCCh:N4Max? on page 604

[:SOURCE<hw>] :BB:EUTRa:UL:PUCCh:N5Max? on page 604

4.7 UL frame configuration settings

Access:

1. Select "LTE General > Link Direction > Uplink (SC-FDMA)".
2. Select "Frame Configuration"

This dialog allows you to configure the subframes and the SC-FDMA resource allocations.

The dialog consists of the following sections:

- [General scheduling configuration settings](#)..... 243
- [Subframe configuration](#)..... 246
- [UL allocation table](#)..... 248

4.7.1 General scheduling configuration settings

Access:

1. Select "General > Link Direction > Uplink (SC-FDMA)".

2. Select "Frame Configuration > General"

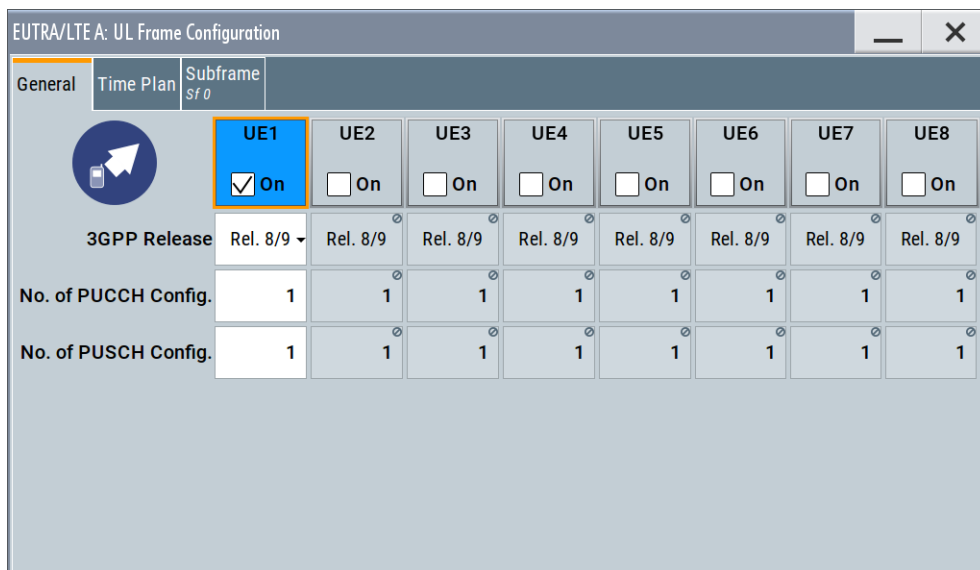

This dialog provides access to the user equipment settings and settings concerning the UL scheduling, like configuring the subframes and adjusting the PUCCH/PUSCH scheduling.

Settings:

UEx..... 244
 3GPP Release..... 244
 Number Of PUCCH/PUSCH Configurations/Number Of Configurable Subframes.....245

UEx

Accesses the [User equipment configuration](#) dialog for configuring the UE settings.

The check box activates or deactivates the selected UE. The 3GPP release the UE is compliant to is displayed.

Note: Disabling the UE deactivates its allocations: the reference signal, PUSCH/PUCCH allocations, and PRACH are not transmitted.

Remote command:
 n.a.

3GPP Release

Sets the 3GPP release version supported by the UE.

Generally, each UE can work in one of the modes: LTE, LTE-A, eMTC or NB-IoT. The available values depend on the installed options and the value of the parameter [Mode](#).

"Mode"	Description	Required options	"3GPP Release"
"LTE"	Standalone LTE	R&S SMM-K55 R&S SMM-K85	"Release 8/9" "LTE-Advanced"
"eMTC/NB-LoT"	Standalone loT	R&S SMM-K115	"eMTC, NB-LoT"
"LTE/eMTC/NB-LoT"	Mixed LTE and loT	R&S SMM-K55 and R&S SMM-K115	"Release 8/9, LTE-Advanced, eMTC, NB-LoT"

Several further settings are enabled only for LTE-A or loT UEs.

Remote command:

[:SOURCE<hw>] :BB:EUTRa:UL:UE<st>:RELease on page 747

Number Of PUCCH/PUSCH Configurations/Number Of Configurable Subframes

- If "3GPP Release > eMTC/NB-LoT":
PUSCH and PUCCH configurations are defined entirely in the "User Equipment Configuration" dialog.
- If "3GPP Release > LTE/LTE-A":
Sets the number of configurable subframes in the up to four configurable frames, i.e. determines the scheduling cycle per UE.
All uplink subframes are filled periodically with the configured subframes except for the Sounding Reference Signal. You can set the SRS individually for each UE in the [User equipment configuration](#) dialog.
The maximum number of configurable subframes depends on the following:
 - Select duplexing mode (TDD or FDD)
 - Configured [TDD frame structure settings](#)
 - If TDD special subframe configuration 10 is used.
 For more detailed information about the maximum number of configurable subframes and for description of the dependencies between the parameters, see [Chapter B.3, "Four configurable frames in uplink and downlink direction"](#), on page 949.
 - For "LTE" UEs, the "No Of Configurable Uplink Subframes" is the same for PUCCH and PUSCH.
 - For "LTE-A" UEs, the scheduling cycles are independent per PUSCH and PUCCH.
The number of configurable subframes can be defined individually per PUCCH and per PUSCH. This enables the configuration of PUCCH and PUSCH with different repetition patterns.

Example: Independent cycles for PUSCH and PUCCH of the same LTE-Advanced UE

As described in the test case 8.2.4, [TS 36.141](#), the PUCCH of the UE has to be transmitted once a frame and the PUSCH - once each eight subframes.

- Set "UE1" > [User equipment configuration](#) > [3GPP Release](#) = LTE-Advanced.
- In the "UL Frame Configuration > Number of Configurable Uplink Subframes" dialog, set "UE1 > PUCCH" = 10
- In the "UL Frame Configuration > Number of Configurable Uplink Subframes" dialog, set "UE1 > PUSCH" = 8
- Configure the PUCCH and PUSCH allocations of UE1 as required.

Example: Independent cycles for PUSCH and PUCCH of the same LTE Rel. 8/9 UE

	UE1	UE2	UE3	UE4	UE5	UE6	UE7	UE8
General	<input checked="" type="checkbox"/> On	<input checked="" type="checkbox"/> On	<input checked="" type="checkbox"/> On	<input type="checkbox"/> On	<input type="checkbox"/> On	<input type="checkbox"/> On	<input type="checkbox"/> On	<input type="checkbox"/> On
3GPP Release	LTE-A	Rel. 8/9	Rel. 8/9	Rel. 8/9	Rel. 8/9	Rel. 8/9	Rel. 8/9	Rel. 8/9
PUCCH Conf.	10	10	8	1	1	1	1	1
PUSCH Conf.	8	10	8	1	1	1	1	1

- Select "UE2" > [UE ID/n_RNTI](#) = UE ID_{UE2}.
- Set "UE3" > [UE ID/n_RNTI](#) = UE ID_{UE2}
- Configure the allocations of as required.
- In the "UL Frame Configuration > Number of Configurable Uplink Subframes" dialog, set "UE2 > PUCCH/PUSCH" = 10
- In the "UL Frame Configuration > Number of Configurable Uplink Subframes" dialog, set "UE3 > PUCCH/PUSCH" = 8

Remote command:

`[:SOURCE<hw>] :BB:EUTRa:UL:UE<st>:CONSubframes:PUCCh` on page 702
`[:SOURCE<hw>] :BB:EUTRa:UL:UE<st>:CONSubframes:PUSCh` on page 702

4.7.2 Subframe configuration

Access:

1. Select "General > Link Direction > Uplink (SC-FDMA)".

2. Select "Frame Configuration > Subframe"

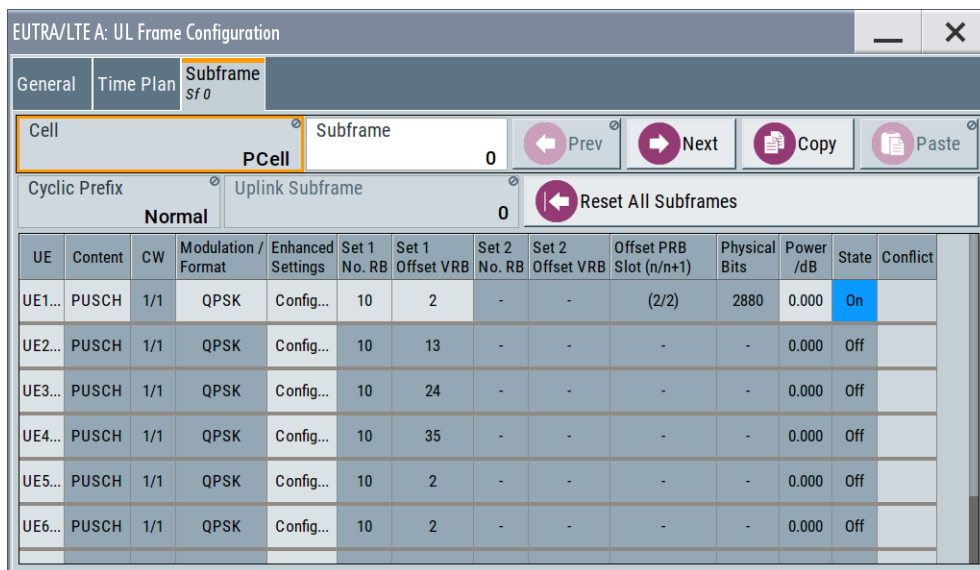

Provided are the settings for selecting and configuring the subframes. In the allocation table section, the individual allocation parameters for a subframe are set.

Cell..... 247
 Subframe..... 247
 Next/Prev..... 247
 Copy/Paste Subframe Settings..... 248
 Cyclic Prefix (UL)..... 248
 Subframe Information..... 248
 Reset All Subframes..... 248

Cell

In enabled "General UL Settings > CA > Activate Carrier Aggregation > On" state, determines the settings of which cell (Primary Cell or SCell) are displayed.

Subframe

Sets the subframe to be configured/displayed in the frame configuration table.

All uplink subframes are filled periodically with the configured subframes except for the Sounding Reference Signal. SRS is set individually for each UE in the [User equipment configuration](#) dialog.

Subframes behind the configurable range of the corresponding UE or channel ([Number Of PUCCH/PUSCH Configurations/Number Of Configurable Subframes](#)) are displayed as read-only.

Remote command:

n.a.

Next/Prev

Navigates through the subframes.

Remote command:
n.a.

Copy/Paste Subframe Settings

Copies/pastes the settings of the selected subframe. Sounding Reference Signals are not considered.

For more detailed information, see [Chapter B.1, "Copy/paste subframe"](#), on page 948.

Remote command:
n.a.

Cyclic Prefix (UL)

Configuration of the cyclic prefix per subframe is only enabled, if the parameter [Cyclic Prefix](#) is set to User Defined.

The number of the SC-FDMA symbols per subframe is set automatically

Remote command:
[\[:SOURCE<hw>\]:BB:EUTRa:UL\[:SUBF<st0>\]:CYCPrefix](#) on page 702

Subframe Information

Displays the kind of the selected subframe, i.e. "Special Subframe", "Uplink Subframe", "Downlink Subframe".

For "Uplink Subframe", it is also shown the uplink subframe number, which is especially useful for TDD duplexing mode.

Remote command:
n.a.

Reset All Subframes

Resets settings of all subframes including cyclic prefix to the default values.

Remote command:
[\[:SOURCE<hw>\]:BB:EUTRa:UL:RSTFrame](#) on page 703

4.7.3 UL allocation table

The resource allocation table is where the individual allocation parameters for a subframe are set.

User Equipment	249
Content (UL)	249
Codeword (UL)	249
Modulation/Format	249
Enhanced Settings UL	250
Set 1/Set 2 No. RB	250
Set 1/Set 2 Offset VRB	251
Offset PRB Slot (n/n+1)	251
Phys. Bits / Total Number of Physical Bits	252
Power (UL)	252
State (UL)	252
Conflict (UL)	253

User Equipment

Accesses the settings of the UE the selected allocation belongs to, see [Chapter 4.8, "User equipment configuration"](#), on page 253.

Remote command:

n.a.

Content (UL)

Selects the content type of the selected allocation.

Use the setting in dialog [User equipment configuration](#) to configure the PUSCH data source.

"eMTC" and "NB-IoT" indicates UEs configured for IoT transmission ("UL Frame Configuration > General > UEx" > [3GPP Release](#)).

The allocation table does not display information on the eMTC/NB-IoT transmission. To access the related setting, select [Enhanced Settings UL](#) > "Config".

Remote command:

```
[ :SOURCE<hw> ] :BB:EUTRa:UL [ :SUBF<st0> ] :ALLoc<ch0>:CONType  
on page 703
```

Codeword (UL)

Option: R&S SMM-K85

Determines whether one or two codewords use the same physical resource, and whether codeword 1/2 or codeword 2/2 is configured with the selected PUSCH allocation.

See also [Figure 2-31](#).

Remote command:

```
[ :SOURCE<hw> ] :BB:EUTRa:UL [ :CELL<ccidx> ] [ :SUBF<st0> ] :ALLoc<ch0> :  
PUSCh:CODWords on page 712
```

Modulation/Format

For PUSCH allocation, this parameter sets the modulation scheme for the allocation.

This parameter is read-only, if a predefined [FRC](#) is selected.

For PUCCH allocation, this parameter sets the PUCCH Format. See [Chapter 2.2.2.3, "Uplink control information transmission"](#), on page 35 for an overview of the allowed PUCCH formats. Use the "SC-FDMA Time Plan" to visualize the position and structure of the configured PUCCH allocation.

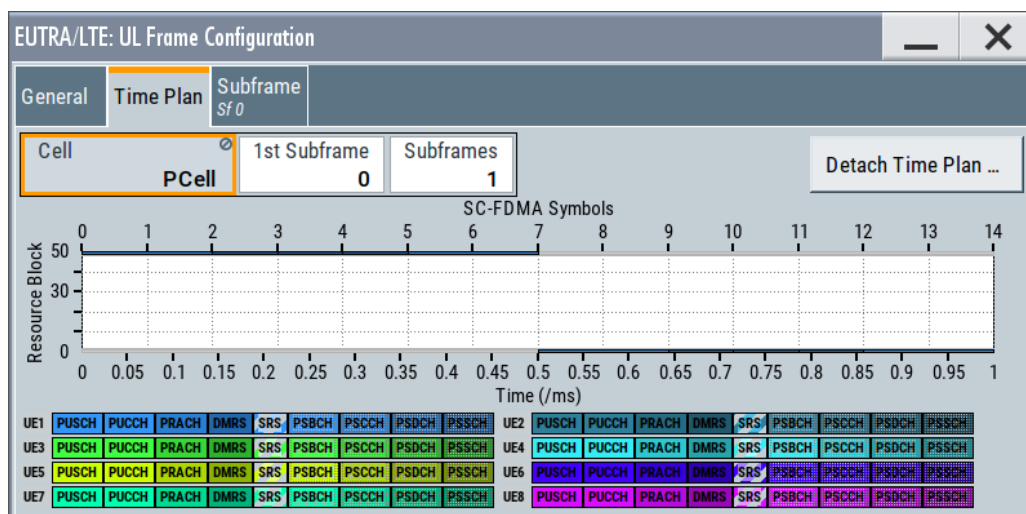

Remote command:

```
[ :SOURce<hw> ] :BB:EUTRa:UL [ :CELL<ccidx> ] [ :SUBF<st0> ] :ALLoc<ch0> [ :CW<cwid> ] [ :PUSCh ] :MODulation on page 703
[ :SOURce<hw> ] :BB:EUTRa:UL [ :SUBF<st0> ] :ALLoc<ch0> [ :PUCCh ] :FORMat on page 703
```

Enhanced Settings UL

Accesses a dialog with further channel configuration settings, see:

- [Chapter 4.9, "Enhanced PUSCH settings"](#), on page 311
- [Chapter 4.10, "Enhanced PUCCH settings"](#), on page 321
- [Chapter 5.3.5.1, "NB-IoT allocation settings"](#), on page 413
- [Chapter 5.3.8.2, "UE-specific eMTC PUSCH transmissions settings"](#), on page 460

Remote command:

n.a.

Set 1/Set 2 No. RB

Option: R&S SMM-K85

The LTE Rel. 10 specification defines PUSCH transmission not only in a continuous frequency region but also in two "sets" or "clusters" of resource blocks (see [Figure 2-28](#)).

The parameter defines the size of the selected allocation in resource blocks of the corresponding set.

This parameter is read-only, if a predefined [FRC](#) is selected.

Example: Clustered PUSCH Transmission

- Select "User Equipment Configuration (UE1) > 3GPP Release > Rel.10".
- In the "UL Frame Configuration > Subframe > Allocation Table", configure the PUSCH allocation of UE1 as follow:
 - "Set 1 No. RB" = 10, "Set 1 Offs. VRB" = 2
 - "Set 2 No. RB" = 5, "Set 2 Offs. VRB" = 25
 - "State" = ON
- Select "Show Time Plan" to visualize the configured allocations

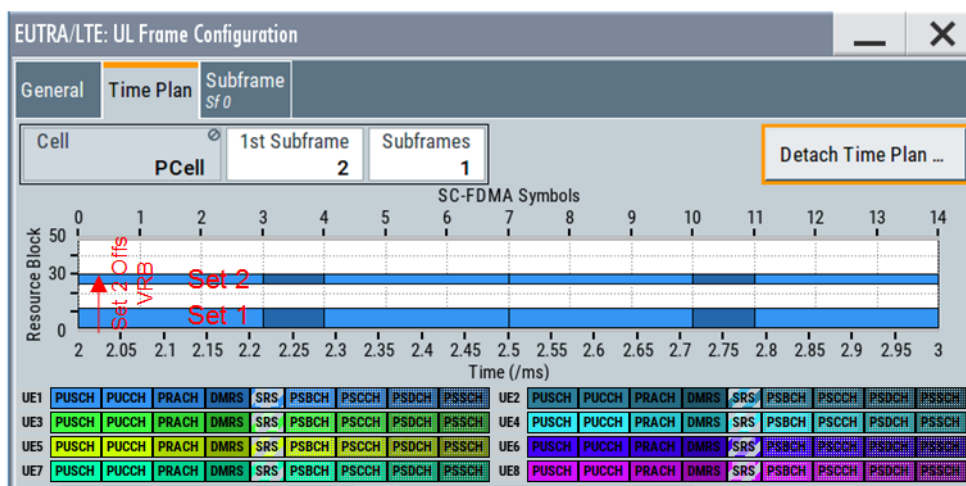

Remote command:

```
[ :SOURCE<hw> ] :BB:EUTRa:UL [ :SUBF<st0> ] :ALLoc<ch0>:RBCount
```

on page 704

```
[ :SOURCE<hw> ] :BB:EUTRa:UL [ :SUBF<st0> ] :ALLoc<ch0>:PUCCh:RBCount?
```

on page 704

```
[ :SOURCE<hw> ] :BB:EUTRa:UL [ :CELL<ccidx> ] [ :SUBF<st0> ] :ALLoc<ch0>:
PUSCh:SET<user>:RBCount on page 704
```

Set 1/Set 2 Offset VRB

Option: R&S SMM-K85

For the corresponding set, sets the virtual resource block offset of the selected sub-frame (see also [Example "Clustered PUSCH Transmission"](#) on page 251).

This parameter is read-only, if a predefined [FRC](#) is selected.

Remote command:

```
[ :SOURCE<hw> ] :BB:EUTRa:UL [ :SUBF<st0> ] :ALLoc<ch0>:VRBoffset
```

on page 704

```
[ :SOURCE<hw> ] :BB:EUTRa:UL [ :CELL<ccidx> ] [ :SUBF<st0> ] :ALLoc<ch0>:
PUSCh:SET<user>:VRBoffset on page 704
```

Offset PRB Slot (n/n+1)

Displays the start resource block of the selected allocation in the first and the second slot of the subframe.

Consider the following interdependencies, if frequency hopping is used:

- The start physical resource blocks in slot n and slot n+1 are set automatically

These values can deviate from the [Set 1/Set 2 Offset VRB](#)

- If an intra-subframe hopping for hopping type 2 is applied, the start resource block in slot 1 is defined by the selected [Number of Sub-bands](#)

Remote command:

```
[ :SOURCE<hw> ] :BB:EUTRa:UL [ :SUBF<st0> ] :SLOT<user0>:ALLoc<ch0>:RBOFFset? on page 705
```

```
[ :SOURCE<hw> ] :BB:EUTRa:UL [ :SUBF<st0> ] :SLOT<user0>:ALLoc<ch0>:PUCCh:RBOFFset? on page 705
```

```
[ :SOURCE<hw> ] :BB:EUTRa:UL [ :CELL<ccidx> ] [ :SUBF<st0> ] :SLOT<user0>:ALLoc<ch0>:PUSCh:SET<gr>:RBOFFset? on page 705
```

Phys. Bits / Total Number of Physical Bits

Displays the size of the selected allocation in bits. The value is set automatically according to the current allocation's settings.

Remote command:

```
[ :SOURCE<hw> ] :BB:EUTRa:UL [ :SUBF<st0> ] :ALLoc<ch0> [ :CW<cwid> ] :PHYSbits? on page 705
```

```
[ :SOURCE<hw> ] :BB:EUTRa:UL [ :SUBF<st0> ] :ALLoc<ch0>:PUCCh:PHYSbits? on page 705
```

```
[ :SOURCE<hw> ] :BB:EUTRa:UL [ :CELL<ccidx> ] [ :SUBF<st0> ] :ALLoc<ch0> [ :CW<cwid> ] :PUSCh:PHYSbits? on page 705
```

Power (UL)

Sets the power for the selected allocation, i.e. PUSCH or PUCCH power level.

The PUSCH power level (P_{PUSCH}) and the PUCCH power level (P_{PUCCH}) can vary per subframe.

Further power-related parameters:

- [UE Power](#) (P_{UE}): for global adjustment of the transmit power of the UE
- [DMRS Power Offset](#) ($P_{\text{DMRS_offset}}$) and [SRS Power Offset](#) ($P_{\text{SRS_offset}}$): for boosting the reference signals, DMRS and SRS, per UE.

Remote command:

```
[ :SOURCE<hw> ] :BB:EUTRa:UL [ :SUBF<st0> ] :ALLoc<ch0>:POWer on page 706
```

```
[ :SOURCE<hw> ] :BB:EUTRa:UL [ :SUBF<st0> ] :ALLoc<ch0>:PUCCh:POWer on page 706
```

```
[ :SOURCE<hw> ] :BB:EUTRa:UL [ :CELL<ccidx> ] [ :SUBF<st0> ] :ALLoc<ch0>:PUSCh:POWer on page 706
```

State (UL)

Sets the allocation to active or inactive state.

- | | |
|-------|---------------------------------------------------------------------------------------------------------------------------------------------------------------------------------------------------------|
| "On" | Enables the allocation of the select UE.
Option: R&S SMM-K119: If TDD special subframe configuration is used, the state of the PUSCH allocations is defined by the parameter State . |
| "Off" | Disables the allocation.
The PUSCH/PUCCH and the DMRS are deactivated.
Other allocations of the same UE and the SRS are not affected. |

- "Auto" Option: R&S SMM- K115
- For IoT allocations with "Content = eMTC/NB-LoT", indicates that it is automatically configured as set in the dialogs:
- [Chapter 5.3.8.2, "UE-specific eMTC PUSCH transmissions settings"](#), on page 460
 - [Chapter 5.3.5.1, "NB-LoT allocation settings"](#), on page 413

Remote command:

`[:SOURce<hw>] :BB:EUTRa:UL [:SUBF<st0>] :ALLoc<ch0> :STATe` on page 706

`[:SOURce<hw>] :BB:EUTRa:UL [:SUBF<st0>] :ALLoc<ch0> :PUCCh:STATe`
on page 706

`[:SOURce<hw>] :BB:EUTRa:UL [:CELL<ccidx>] [:SUBF<st0>] :ALLoc<ch0> :PUSCh:STATe` on page 706

Conflict (UL)

Indicates a conflict between UEs and in case an allocation exceeds the available number of resource blocks.

For more information, see [Chapter A.2, "Uplink"](#), on page 944.

Remote command:

`[:SOURce<hw>] :BB:EUTRa:UL [:SUBF<st0>] :ALLoc<ch0> :CONFlIct?`

on page 706

`[:SOURce<hw>] :BB:EUTRa:UL [:SUBF<st0>] :ALLoc<ch0> :PUCCh:CONFlIct?`
on page 706

`[:SOURce<hw>] :BB:EUTRa:UL [:CELL<ccidx>] [:SUBF<st0>] :ALLoc<ch0> :PUSCh:CONFlIct?` on page 706

4.8 User equipment configuration

Access:

1. Select "LTE General > Link Direction > Uplink (SC-FDMA)".
2. Select "Frame Configuration > General > Select User Equipment > UEx".

You can configure up to four scheduled user equipments (UE) and freely distribute them over the time. You can also configure the structure of the demodulation reference signal (DMRS) and the sounding reference signal (SRS) per UE.

The dialog consists of the following sections:

- [Common settings](#)..... 254
- [Physical uplink control channel \(PUCCH\)](#)..... 256
- [FRC configuration](#)..... 257
- [Physical uplink shared channel \(PUSCH\)](#)..... 261
- [Demodulation reference signal \(DMRS\)](#)..... 266
- [Sounding reference signal \(SRS\)](#)..... 268
- [Sidelink settings](#)..... 278

- [Antenna port mapping](#).....304
- [PRACH power ramping](#).....307
- [PRACH configuration](#).....308

4.8.1 Common settings

Access:

1. Select "General > Link Direction > Uplink (SC-FDMA)"
2. Select "Frame Configuration > General > Select User Equipment > UEx".
3. Select "Common".

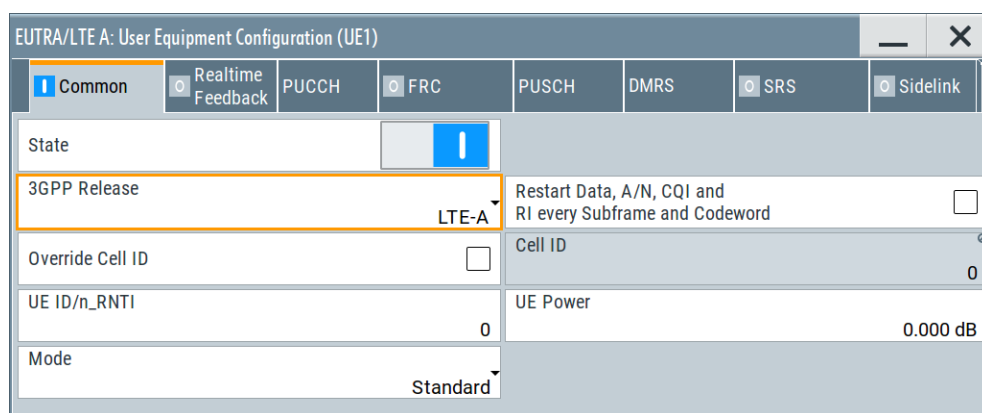

The available settings allow you to configure the state of the user equipment, the UE's release, UE ID, and the operational mode.

Settings:

State	254
3GPP Release	255
Restart Data, A/N, CQI and RI Every Subframe and Codeword/Restart Data and A/N Every Subframe	255
Override Cell ID	255
Cell ID	255
UE ID/n_RNTI	255
UE Power	255
Mode	256

State

Activates or deactivates the user equipment.

Disabling the UE deactivates its allocations: the reference signal, PUSCH (or PUCCH) allocations, and PRACH are not transmitted.

Remote command:

[:SOURce<hw>] :BB:EUTRa:UL:UE<st>:STATe on page 748

3GPP Release

Sets the 3GPP release version supported by the UE.

Generally, each UE can work in one of the modes: LTE, LTE-A, eMTC or NB-IoT. The available values depend on the installed options and the value of the parameter [Mode](#).

"Mode"	Description	Required options	"3GPP Release"
"LTE"	Standalone LTE	R&S SMM-K55 R&S SMM-K85	"Release 8/9" "LTE-Advanced"
"eMTC/NB-IoT"	Standalone IoT	R&S SMM-K115	"eMTC, NB-IoT"
"LTE/eMTC/NB-IoT"	Mixed LTE and IoT	R&S SMM-K55 and R&S SMM-K115	"Release 8/9, LTE-Advanced, eMTC, NB-IoT"

Several further settings are enabled only for LTE-A or IoT UEs.

Remote command:

[\[:SOURCE<hw>\]:BB:EUTRa:UL:UE<st>:RELease](#) on page 747

Restart Data, A/N, CQI and RI Every Subframe and Codeword/Restart Data and A/N Every Subframe

If activated, the indicated values are restarted at the specified intervals.

Remote command:

[\[:SOURCE<hw>\]:BB:EUTRa:UL:UE<st>:DACRestart](#) on page 747

Override Cell ID

If carrier aggregation is disabled, you can enable this parameter and set an user-defined cell ID for the selected user.

This cell ID value is used in the signal calculation for the particular UE instead of the common cell ID, set with the parameter "General UL Settings > Cell" > [Cell ID](#).

Remote command:

[\[:SOURCE<hw>\]:BB:EUTRa:UL:UE<st>:OCID:STATe](#) on page 749

Cell ID

If "[Override Cell ID](#)" on page 255 > "On", with this parameter you set an user-defined cell ID for the selected user.

This cell ID value is used in the signal calculation of UE instead of the common cell ID, set with the parameter "General UL Settings > Cell" > [Cell ID](#).

Remote command:

[\[:SOURCE<hw>\]:BB:EUTRa:UL:UE<st>:CID](#) on page 749

UE ID/n_RNTI

Sets the radio network temporary identifier (RNTI) of the UE.

Remote command:

[\[:SOURCE<hw>\]:BB:EUTRa:UL:UE<st>:ID](#) on page 748

UE Power

Sets the power level of the selected UE (P_{UE}).

The P_{UE} determines the power levels of the reference signals (DMRS and SRS) and of the allocations, PUSCH (P_{PUSCH}) and PUCCH (P_{PUCCH}). Use the P_{UE} for global adjustment of the transmit power of the UEs.

Further power-related parameters:

- **Power**: varies the PUSCH and PUCCH power per subframe.
- **Power, dB**: varies the PUSCH and PUCCH power per eMTC transmission
- **Power, dB**: varies the NPUSCH (P_{NPUSCH}) power per NB-IoT transmission
- **DMRS Power Offset** (P_{DMRS_offset}): boosts the reference signals DMRS per UE.
- **"SRS Power Offset"** on page 270 (P_{SRS_offset}): boosts the reference signals SRS per UE.

Remote command:

[:SOURCE<hw>] :BB:EUTRa:UL:UE<st>:POWER on page 748

Mode

Selects whether the user equipment is in standard or in PRACH mode.

If UL carrier aggregation is used, PRACH mode is disabled.

See:

- [Chapter 4.8.10, "PRACH configuration"](#), on page 308
- [Chapter 5.3.10, "eMTC PRACH settings"](#), on page 477
- [Chapter 5.3.6, "NPRACH settings"](#), on page 422

Remote command:

[:SOURCE<hw>] :BB:EUTRa:UL:UE<st>:MODE on page 748

4.8.2 Physical uplink control channel (PUCCH)

Option: R&S SMM-K85 for generation of LTE signals with UL-MIMO. PUCCH is available in the primary cell (PCell) only.

Access:

1. Select "General > Link Direction > Uplink (SC-FDMA)"
2. Select "Frame Configuration > General > Select User Equipment > UEx"
3. Select "User Equipment Configuration > Common > 3GPP Release > LTE-Advanced"
4. Select "PUCCH".

With these settings, you define the number of antenna ports used for each of the PUCCH formats.

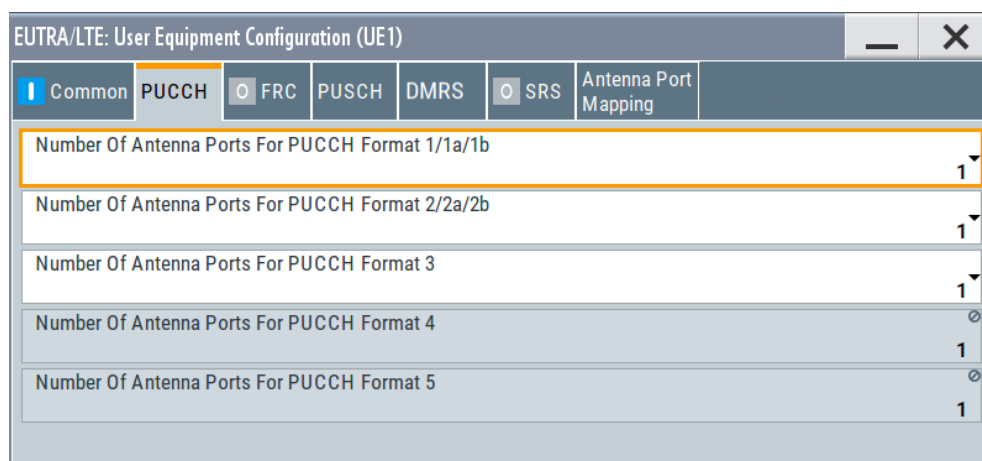

- Set the number of available ports for PUCCH per PUCCH format.

Settings:

Number of Antenna Ports for PUCCH per PUCCH Format

For [3GPP Release](#) = "LTE-Advanced" UEs, sets the number of antenna ports used for every PUCCH format transmission.

eMTC UEs ("3GPP Release = eMTC") support transmission with one antenna port.

Remote command:

[:SOURCE<hw>] :BB:EUTRa:UL:UE<st>:PUCCh:F1Naport on page 762

[:SOURCE<hw>] :BB:EUTRa:UL:UE<st>:PUCCh:F2Naport on page 762

[:SOURCE<hw>] :BB:EUTRa:UL:UE<st>:PUCCh:F3Naport on page 762

[:SOURCE<hw>] :BB:EUTRa:UL:UE<st>:PUCCh:F4Naport? on page 761

[:SOURCE<hw>] :BB:EUTRa:UL:UE<st>:PUCCh:F5Naport? on page 761

4.8.3 FRC configuration

Access:

- Select "General > Link Direction > Uplink (SC-FDMA)".
- Select "Frame Configuration > General > Select User Equipment > UEx".

3. Select "FRC".

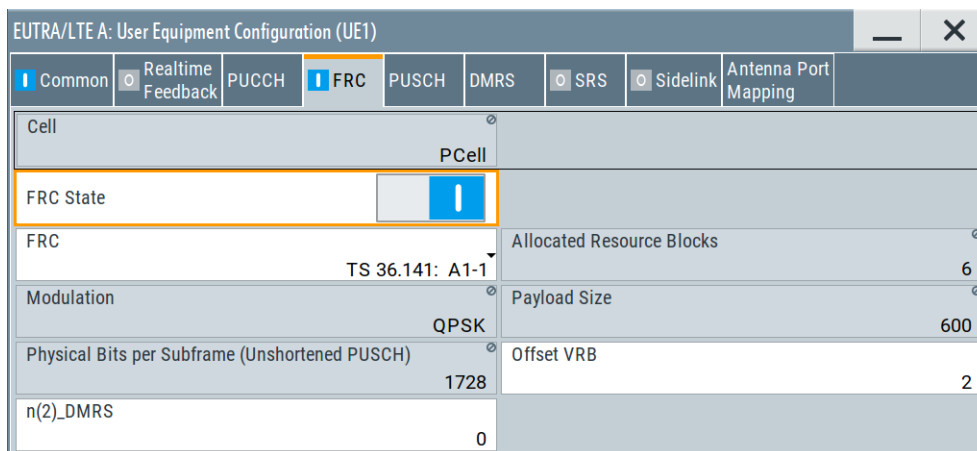

This dialog enables a quick configuration of the predefined fixed reference channels (FRC) according to:

- [TS 36.141](#), Annex A "Reference measurement channels"
- [TS 36.521](#), Annex A "Measurement channels".

If "FRC" is enabled, several parameters are predefined and their values are displayed as read-only values, see [Table 4-11](#).

Table 4-11: Parameters affected by the RFC configuration

Dialog	Parameter	Value
"UE Configuration"	Scrambling	On
	Channel coding state	On
	Interleaver	On
	SRS state	Off (the SRS can be activated manually if FRC state is on)
"UL Allocation Table"	Modulation	According to the selected FRC
PUSCH allocations of the corresponding UE in all subframes	No. RB	According to the selected FRC
"Enhanced PUSCH Settings"	Frequency hopping	Off
For the corresponding UE in all subframes	HARQ ACK type	None
	Number of CQI bits	0
	Number of coded CQI bits	0
	Transport block Size/Payload	According to the selected FRC

Settings:

[Cell](#)..... 259

[FRC State](#)..... 259

[FRC](#)..... 259

Allocated Resource Blocks.....	260
Modulation (FRC).....	260
Payload Size (FRC).....	260
Physical Bits Per Subframe (Unshortened PUSCH).....	261
Offset VRB (FRC).....	261
n(2)_DMRS (FRC).....	261

Cell

In enabled "General UL Settings > CA > Activate Carrier Aggregation > On" state, determines the settings of which cell (Primary Cell or SCell) are displayed.

FRC State

Enables/disables FRC configuration.

"On" If "FRC" is enabled, several parameters are predefined and their values are displayed as read-only values. To reconfigure any of these parameters, disable the FRC configuration. An exception is the SRS state. You can change it even while an FRC is used.

"Off" FRC cannot be used if **Cyclic Prefix** = "User Defined".

Remote command:

```
[ :SOURCE<hw> ] :BB:EUTRa:UL:UE<st> [ :CELL<ccid> ] :FRC:STATE  
on page 751
```

FRC

Selects a predefined fixed reference channel according to [TS 36.141](#) or to [TS 36.521](#).

3GPP specifies the FRCs for a specific channel bandwidth (i.e. number of resource blocks) and cyclic prefix. Depending on the current configuration, some FRCs are not listed.

If **Cyclic Prefix** = "User Defined", FRC cannot be used.

Table 4-12: Supported FRCs from 3GPP TS 36.141

FRC	Description
A1_1 to A1_7	FRC for reference sensitivity and in-channel selectivity (QPSK, R=1/3)
A2_1 to A2_3	FRC for dynamic range (16QAM, R=2/3)
A3_1 to A3_7	FRC for performance requirements (QPSK 1/3)
A4_1 to A4_8	FRC for performance requirements (16QAM 3/4)
A5_1 to A5_7	FRC for performance requirements (64QAM 5/6)
A7_1 to A7_6	FRC for UL timing adjustment (scenario 1)
A8_1 to A8_6	FRC for UL timing adjustment (scenario 2)
A12_1 to A12_6	FRC for performance requirements (QPSK 0.36)
A13_1 to A13_6	FRC for performance requirements (16QAM 1/2)
A17_1 to A17_6	Option: R&S SMM-K119 FRC for performance requirements (256QAM, 5/6)

FRC	Description
A18_1 to A18_6	Option: R&S SMM-K119 FRC for PUSCH transmission in UpTPS (16QAM, 0.56) Available in "Duplexing = TDD" and TDD Special Subframe Config = "10" .
A19_1 to A19_6	Option: R&S SMM-K119 FRC for PUSCH transmission in UpTPS (256QAM, 0.69) Available in "Duplexing = TDD" and TDD Special Subframe Config = "10" .
A21_1 to A21_6	Option: R&S SMM-K119 FRC for performance requirements (QPSK 3/5)
A22_1 to A22_4	Option: R&S SMM-K119 FRC for performance requirements (64QAM 1/2)

Table 4-13: Supported FRCs from 3GPP TS 36.521-1

FRC (Duplexing = FDD)	FRC (Duplexing = TDD)	Description
A.2.2.1.1	A.2.3.1.1	Reference channels for QPSK with full RB allocation
A.2.2.1.2	A.2.3.1.2	Reference channels for 16-QAM with full RB allocation
A.2.2.2.1	A.2.3.2.1	Reference channels for QPSK with partial RB allocation
A.2.2.2.2	A.2.3.2.2	Reference channels for 16-QAM with partial RB allocation
A.2.2.3	A.2.3.3	Uplink reference channels for sustained data-rate test

Remote command:

```
[ :SOURCE<hw> ] :BB:EUTRa:UL:UE<st> [ :CELL<ccid> ] :FRC:TYPE
on page 751
```

Allocated Resource Blocks

Displays the number of the allocated resource blocks for the selected FRC. For FRCs "A.2.2.2.1" and "A.2.2.2.2", this parameter can also be set to different values according to [TS 36.521](#).

Remote command:

```
[ :SOURCE<hw> ] :BB:EUTRa:UL:UE<st> [ :CELL<ccid> ] :FRC:ALRB
on page 749
```

Modulation (FRC)

Displays the modulation for the selected FRC.

Remote command:

```
[ :SOURCE<hw> ] :BB:EUTRa:UL:UE<st> [ :CELL<ccid> ] :FRC:MODulation?
on page 750
```

Payload Size (FRC)

Displays the payload size for the selected FRC.

Remote command:

```
[ :SOURCE<hw> ] :BB:EUTRa:UL:UE<st> [ :CELL<ccidx> ] :FRC:PASize?  
on page 750
```

Physical Bits Per Subframe (Unshortened PUSCH)

Displays the total number of physical bits available for the PUSCH allocation per subframe, in that unshortened PUSCH is transmitted. Shortened PUSCH transmission occurs in a cell-specific SRS subframe or in subframes where SRS is transmitted.

Remote command:

```
[ :SOURCE<hw> ] :BB:EUTRa:UL:UE<st> [ :CELL<ccidx> ] :FRC:TNOBits?  
on page 751
```

Offset VRB (FRC)

Sets the virtual resource block (VRB) offset for all PUSCH allocation of the selected UE in all subframes.

The **VRB Offset** set for the individual subframes in the "UL Allocation Table" are overwritten.

Remote command:

```
[ :SOURCE<hw> ] :BB:EUTRa:UL:UE<st> [ :CELL<ccidx> ] :FRC:VRBoffset  
on page 752
```

n(2)_DMRS (FRC)

Sets the UE-specific part of the demodulation reference signal (DMRS) index for all PUSCH allocation of the selected UE in all subframes.

The "Enhanced PUSCH Settings" > **n(2)_DMRS, λ (Layer λ)** set for the individual subframes for the corresponding UE is overwritten.

Remote command:

```
[ :SOURCE<hw> ] :BB:EUTRa:UL:UE<st> [ :CELL<ccidx> ] :FRC:N2DMrs  
on page 750
```

4.8.4 Physical uplink shared channel (PUSCH)

Access:

1. Select "General > Link Direction > Uplink (SC-FDMA)".
2. Select "Frame Configuration > General > Select User Equipment > UEx"

3. Select "PUSCH"

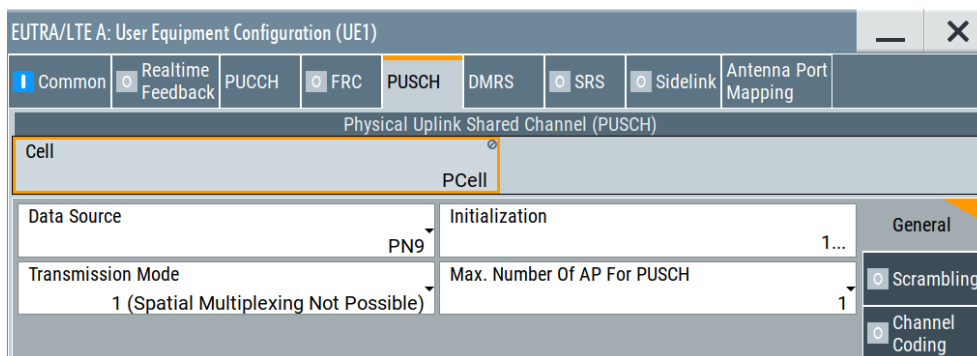

In this dialog, the data source for the PUSCH can be selected and the channel coding can be configured. Use the [Enhanced PUSCH settings](#) dialog to adjust the additional settings for channel coding of the control information and the multiplexing of the data and control information.

Settings:

- Cell..... 262
- NPUSCH + SRS simultaneous Tx..... 262
- Data Source (tab General)..... 263
- Initialization (tab General)..... 263
- Transmission Mode (tab General)..... 263
- Max. Number of AP for PUSCH (tab General)..... 264
- State (PUSCH tab Scrambling)..... 264
- Channel Coding and Multiplexing (PUSCH) (tab Channel Coding)..... 264
 - L State..... 265
 - L Mode..... 265
 - L I_HARQ_offset..... 265
 - L I_RI_offset..... 265
 - L I_CQI_offset..... 265
 - L O_CQI-Min..... 265
- PUSCH in UpPTS..... 266
 - L State..... 266
 - L Less DMRS..... 266
 - L Number of Symbols..... 266

Cell

In enabled "General UL Settings > CA > Activate Carrier Aggregation > On" state, determines the settings of which cell (Primary Cell or SCell) are displayed.

NPUSCH + SRS simultaneous Tx

For "UEx > 3GPP Release = NB-LoT", enables simultaneous transmission of NPUSCH and SRS.

Remote command:

[:SOURCE<hw>] :BB:EUTRa:UL:UE<st>:NIOT:NPSSim on page 908

Data Source (tab General)

Selects the data source for the PUSCH allocation.

If [Restart Data, A/N, CQI and RI Every Subframe and Codeword > Off](#), new data is retrieved from the data source for every subframe where PUSCH is configured.

The following standard data sources are available:

- "All 0, All 1"
An internally generated sequence containing 0 data or 1 data.
- "PNxx"
An internally generated pseudo-random noise sequence.
- "Pattern"
An internally generated sequence according to a bit pattern.
Use the "Pattern" box to define the bit pattern.
- "Data List/Select DList"
A binary data from a data list, internally or externally generated.
Select "Select DList" to access the standard "Select List" dialog.
 - Select the "Select Data List > navigate to the list file *.dm_iqd > Select" to select an existing data list.
 - Use the "New" and "Edit" functions to create internally new data list or to edit an existing one.
 - Use the standard "File Manager" function to transfer external data lists to the instrument.

See also:

- Section "Modulation Data" in the R&S SMM100A user manual.
- Section "File and Data Management" in the R&S SMM100A user manual.
- Section "Data List Editor" in the R&S SMM100A user manual

Remote command:

```
[ :SOURce<hw> ] :BB:EUTRa:UL:UE<st> [ :CELL<ccidx> ] :PUSCh:DATA
```

on page 756

```
[ :SOURce<hw> ] :BB:EUTRa:UL:UE<st> [ :CELL<ccidx> ] :PUSCh:PATtern
```

on page 756

```
[ :SOURce<hw> ] :BB:EUTRa:UL:UE<st> [ :CELL<ccidx> ] :PUSCh:DSElect
```

on page 757

Initialization (tab General)

Selects the starting seed for data sources for the PUSCH allocation.

Remote command:

```
[ :SOURce<hw> ] :BB:EUTRa:UL:UE<st> [ :CELL<ccidx> ] :PUSCh:INITpattern
```

on page 757

Transmission Mode (tab General)

Option: R&S SMM-K85

For [3GPP Release](#) = "LTE-A", sets the PUSCH transmission mode according to [TS 36.213](#).

"1 (Spatial Multiplexing not Possible)"

This is the predefined value if:

- "FRC State > On"
- [3GPP Release](#) = "eMTC/NB-IoT"

"2 (Spatial Multiplexing Possible)"

See also "Uplink MIMO" on page 48.

Remote command:

`[:SOURCE<hw>] :BB:EUTRa:UL:UE<st> [:CELL<ccid>] :PUSCh:TXMode`
on page 757

Max. Number of AP for PUSCH (tab General)

Option: R&S SMM-K85

For 3GPP Release = Release 10 UEs, sets the number of antenna ports (AP) for PUSCH transmission for that the UE is configured.

Transmission Mode (tab General)	"1 (Spatial Multiplexing not Possible)"	"2 (Spatial Multiplexing Possible)"
"Number of Antenna Ports for PUSCH"	1	2 or 4

To set the currently used number of antenna ports, use the parameter [Number of Used Antenna Port](#).

In MIMO configurations, the "Max. Number of Antenna Ports for PUSCH" is set automatically to 2.

Remote command:

`[:SOURCE<hw>] :BB:EUTRa:UL:UE<st> [:CELL<ccid>] :PUSCh:NAPort`
on page 758

State (PUSCH tab Scrambling)

Enables/disables scrambling for all PUSCH allocations of the corresponding UE.



This parameter is always enabled, if a predefined FRC is selected.

Remote command:

`[:SOURCE<hw>] :BB:EUTRa:UL:UE<st> [:CELL<ccid>] :PUSCh:SCRambling:STATE` on page 758

Channel Coding and Multiplexing (PUSCH) (tab Channel Coding)

Comprises the following settings:

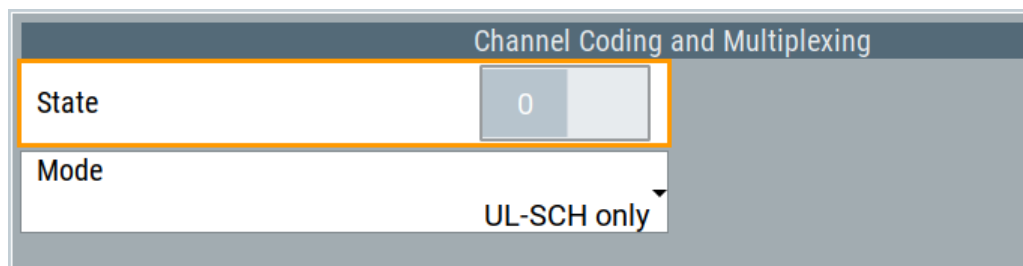

State ← **Channel Coding and Multiplexing (PUSCH) (tab Channel Coding)**

Enables/disables channel coding and multiplexing of data and control information for all PUSCH allocations of the corresponding UE.

If this parameter is disabled, the content retrieved from the [Data Source](#) is forwarded to the scrambler without any coding processing.

Additional parameters for the encoding of control information can be set in [Enhanced PUSCH settings](#) dialog.

This parameter is always enabled, if a predefined [FRC](#) is selected.

Remote command:

```
[ :SOURCE<hw> ] :BB:EUTRa:UL:UE<st> [ :CELL<ccidx> ] :PUSCh:CCODing:
STATe on page 758
```

Mode ← **Channel Coding and Multiplexing (PUSCH) (tab Channel Coding)**

Defines the information transmitted on the PUSCH.

"UCI+UL-SCH" Control information and data are multiplexed into the PUSCH.

"UL-SCH" Only data is transmitted on PUSCH.

"UCI only" Only uplink control information is transmitted on PUSCH.

Remote command:

```
[ :SOURCE<hw> ] :BB:EUTRa:UL:UE<st> [ :CELL<ccidx> ] :PUSCh:CCODing:
MODE on page 759
```

I_HARQ_offset ← **Channel Coding and Multiplexing (PUSCH) (tab Channel Coding)**

Sets the HARQ-ACK offset index for control information MCS offset determination according to [TS 36.213](#), chapter 8.6.3.

Remote command:

```
[ :SOURCE<hw> ] :BB:EUTRa:UL:UE<st> [ :CELL<ccidx> ] :PUSCh:CCODing:
IHARqoffset on page 759
```

I_RI_offset ← **Channel Coding and Multiplexing (PUSCH) (tab Channel Coding)**

Sets the RI offset index for control information MCS offset determination according to [TS 36.213](#), chapter 8.6.3.

Remote command:

```
[ :SOURCE<hw> ] :BB:EUTRa:UL:UE<st> [ :CELL<ccidx> ] :PUSCh:CCODing:
IRIoffset on page 760
```

I_CQI_offset ← **Channel Coding and Multiplexing (PUSCH) (tab Channel Coding)**

Sets the CQI offset index for control information MCS offset determination according to [TS 36.213](#), chapter 8.6.3.

Remote command:

```
[ :SOURCE<hw> ] :BB:EUTRa:UL:UE<st> [ :CELL<ccidx> ] :PUSCh:CCODing:
ICQioffset on page 759
```

O_CQI-Min ← **Channel Coding and Multiplexing (PUSCH) (tab Channel Coding)**

(Enabled in "UCI only" transmission)

Sets the parameter O-CQI-Min, where O_CQI-Min is the number of CQI bits including CRC bits assuming rank equals to 1.

Remote command:

```
[ :SOURCE<hw> ] :BB:EUTRa:UL:UE<st> [ :CELL<ccidx> ] :PUSCh:CCODing:
OCQimin on page 760
```

PUSCH in UpPTS

Option: R&S SMM-K119

Access: "Link Direction = Uplink", "Duplexing Mode = TDD", "General Settings > Physical > TDD Special Subframe Configuration = 10", "Frame Configuration > UEx > PUSCH > PUSCH in UpPTS".

The following parameters are defined for each cell, if TDD is used and the cell is configured with [TDD Special Subframe Config](#) = "10".

State ← PUSCH in UpPTS

Enables PUSCH transmission in the UpPTS part of the special subframe.

If enabled, you can further configure the PUSCH for the corresponding subframe in the "UL Frame Configuration > Subframe > Allocation table". The PUSCH state ("[State \(UL\)](#)" on page 252) is read-only and is set as set with the "UL Frame Configuration > General > UEx > PUSCH > State" parameter.

Remote command:

```
[ :SOURCE<hw> ] :BB:EUTRa:UL:UE<st> [ :CELL<ccidx> ] :PUSCh:UPPTs:STAtE
on page 760
```

Less DMRS ← PUSCH in UpPTS

If enabled, the number of used demodulation reference signals (DMRS) is reduced.

Remote command:

```
[ :SOURCE<hw> ] :BB:EUTRa:UL:UE<st> [ :CELL<ccidx> ] :PUSCh:UPPTs:LDMRS
on page 761
```

Number of Symbols ← PUSCH in UpPTS

Sets the number of symbols used for the PUSCH transmission.

The available number of symbols depends on the used [Cyclic Prefix](#) and whether [Less DMRS](#) is enabled.

Remote command:

```
[ :SOURCE<hw> ] :BB:EUTRa:UL:UE<st> [ :CELL<ccidx> ] :PUSCh:UPPTs:NSYM
on page 761
```

4.8.5 Demodulation reference signal (DMRS)

Access:

1. Select "General > Link Direction > Uplink (SC-FDMA)".
2. Select "Frame Configuration > General > Select User Equipment > UEx".

3. Select "DMRS".

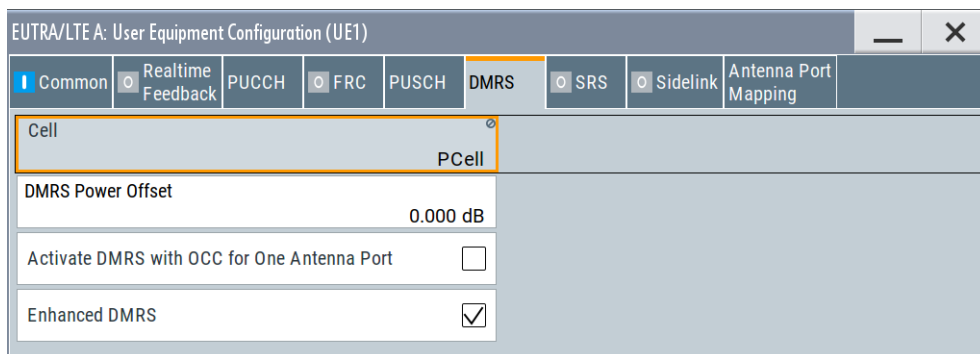

Comprises the parameters of the demodulation reference signal.

Settings:

Cell..... 267
 DMRS Power Offset..... 267
 Activate DMRS with OCC for One Antenna Port..... 267
 Enhanced DMRS..... 268

Cell

In enabled "General UL Settings > CA > Activate Carrier Aggregation > On" state, determines the settings of which cell (Primary Cell or SCell) are displayed.

DMRS Power Offset

Sets the power offset of the DMRS relative to the power level of the PUSCH or PUCCH allocation of the corresponding subframe.

The selected DMRS power offset (P_{DMRS_Offset}) applies for all subframes.

Depending on the allocation of the subframe, the effective power level of the DMRS is calculated as following:

$$P_{DMRS} = P_{UE} + P_{PUSCH/PUCCH} + P_{DMRS_Offset}$$

The PUSCH and PUCCH power levels (P_{PUSCH} and P_{PUCCH}) can vary per subframe.

For global adjustment of the transmit power of the corresponding UE, use the parameter **UE Power** (P_{UE}).

Remote command:

```
[ :SOURCE<hw> ] :BB:EUTRa:UL:UE<st> [ :CELL<ccid> ] :REFSig:DRS:POWoffset on page 762
```

Activate DMRS with OCC for One Antenna Port

Option: R&S SMM-K85

For UEs with **3GPP Release** = "LTE-A", activate demodulation reference signal (DMRS) with an orthogonal cover code (OCC) even if only one antenna port is used.

Remote command:

```
[ :SOURCE<hw> ] :BB:EUTRa:UL:UE<st> [ :CELL<ccid> ] :REFSig:DRS:DWOCc on page 762
```

Enhanced DMRS

Option: R&S SMM-K119

Sets the higher-layer parameter `ul-DMRS-IFDMA` as defined in TS 36.211 and TS 36.212.

The combination of the two parameters [Enhanced DMRS](#) > "On" and [Bit for DMRS Mapping Table](#) > "On" enables mapping the DMRS sequence on each second subcarrier.

Remote command:

`[:SOURCE<hw>] :BB:EUTRa:UL:UE<st> [:CELL<ccidx>] :REFSig:DRS:ENHanced` on page 763

4.8.6 Sounding reference signal (SRS)

Access:

1. Select "General > Link Direction > Uplink (SC-FDMA)".
2. Select "Frame Configuration > General > Select User Equipment > UEx".
3. Select "3GPP Release > LTE-Advanced".
4. Select "SRS".

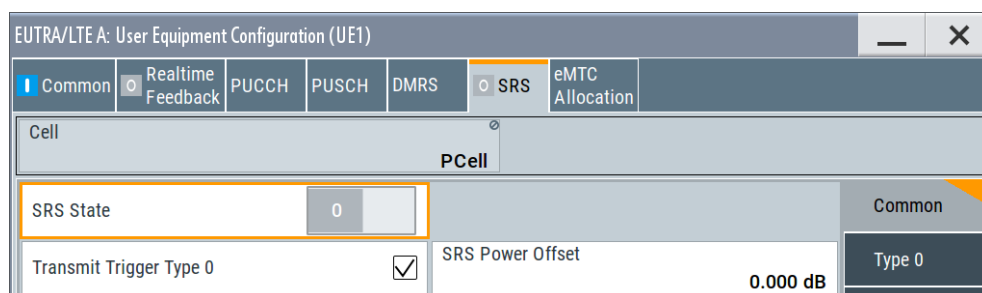

For LTE-Advanced UEs, the dialog consists of several subtabs, one for the "trigger type 0" SRS and further for the SRS sets.

Number Of Antenna Ports For SRS		1	Common
SRS Cyclic Shift n_cs (First AP)		0	
SRS Structure			Type 0
Configuration Index I_SRS	1	Periodicity T_SRS	DCI 0
		2 ms	DCI 1A/ 2B/2C/2D
Subframe Offset T_offset	1	SRS Bandwidth B_SRS	DCI 4 Set 1
		0	DCI 4 Set 2
Transmission Comb Num K TC	2	Transmission Comb k TC	DCI 4 Set 3
		0	
Freq. Domain Position n_RRC	0	Number of Transmissions	
		0	
Subframes for Transmission			
	1	2	3
	4	5	6
	7	8	9
	10	Conflict	
1 - 10			
ARB Sequence Length			
Suggested	Current	Adjust Length	ARB Settings ...
1 Frames	1 Frames		

In the "SRS Structure" section, you can configure the **UE-specific SRS parameters** according to [TS 36.213](#) and [TS 36.211](#).

The **cell-specific parameters**, necessary for the complete definition of the SRS structure and SRS mapping, are configurable in the "General UL Settings" dialog.

See [General UL settings](#).

To visualize the SRS transmission, use the SC-FDMA time plan.

Settings:

- Cell..... 270
- SRS State..... 270
- Transmit Trigger Type 0..... 270
- SRS Power Offset..... 270
- SRS Set Configuration..... 271
 - Number of Antenna Ports for SRS..... 271
 - SRS Cyclic Shift n_CS (First AP)..... 271
 - SRS UpPTS Add..... 271
 - SRS Structure..... 272
 - Configuration Index I_SRS..... 272
 - Periodicity T_SRS..... 272
 - Subframe Offset T_offset..... 273
 - SRS Bandwidth B_SRS..... 274
 - Transmission Comb Num k TC..... 276
 - Transmission Comb k TC..... 276
 - Hopping Bandwidth b_hop..... 276
 - Freq. Domain Position n_RRC..... 277
 - Number of Transmissions..... 277
 - Subframes for Transmission..... 277

L Suggested.....	277
L Adjust Length.....	278
L ARB Settings.....	278

Cell

In enabled "General UL Settings > CA > Activate Carrier Aggregation > On" state, determines the settings of which cell (Primary Cell or SCell) are displayed.

SRS State

Enables/disables sending of SRS for the corresponding UE.

In the symbols reserved for SRS transmission, PUSCH is not transmitted.

Remote command:

```
[ :SOURCE<hw> ] :BB:EUTRa:UL:UE<st> [ :CELL<ccidx> ] :REFSig:SRS:STATE
on page 763
```

Transmit Trigger Type 0

The 3GPP specification defines two types of SRS transmission:

- **Periodic SRS**
SRS occurs at regular time intervals.
Periodic SRS is referred as "trigger type 0" SRS. It is known from LTE Rel. 8
- **Aperiodic SRS**
The aperiodic SRS transmission is a single (one-shot) transmission.
Aperiodic SRS is referred as "trigger type 1" SRS. It is introduced by LTE Rel. 10.

"On"	Trigger type 0 is used. The SRS is configured by higher levels. To configure the SRS structure, use the settings in the "Type 0" dialog .
"Off"	Trigger type 1 is used. The SRS is triggered by the PDCCH DCI content, in particular by the DCI format 0/4/1A/2B/2C/2D (DCI formats 2B/2C for TDD only). To configure the SRS structure, use the dedicated settings in the "DCI 0/1A/2B/2C/2D/4 Set 1 to 3" dialogs.

Remote command:

```
[ :SOURCE<hw> ] :BB:EUTRa:UL:UE<st> [ :CELL<ccidx> ] :REFSig:SRS:TT0
on page 763
```

SRS Power Offset

Sets the power offset of the SRS relative to the power of the corresponding UE.

The selected SRS power offset applies for all subframes.

The effective power level of the SRS is calculated as follows:

$$P_{\text{SRS}} = P_{\text{UE}} + P_{\text{SRS_Offset}}$$

For global adjustment of the transmit power of the corresponding UE, use the parameter **UE Power** (P_{UE}).

Remote command:

```
[ :SOURCE<hw> ] :BB:EUTRa:UL:UE<st> [ :CELL<ccidx> ] :REFSig:SRS:
POWoffset on page 764
```

SRS Set Configuration

Rel. 8/9 UEs support only "trigger type 0" SRS. There is one SRS set of parameters and one tab, "Type 0", where the SRS structure is defined.

For LTE-Advanced/eMTC UEs, the aperiodic SRS is triggered by the "SRS Request" flag in one of the DCI formats 0/1A/4/2B/2C/2D:

- Triggering aperiodic SRS by using DCI format 0 requires one dedicated SRS set of parameters ("DCI 0")
- The triggering by using DCI formats 1A/2A/2B/2C uses a common SRS set ("DCI 1A/2B/2C/2D")
- For the triggering by DCI format 4, the specification defines 3 SRS sets ("DCI 4 Set 1", "DCI 4 Set 2" and "DCI 4 Set 3")

Number of Antenna Ports for SRS ← SRS Set Configuration

Option: R&S SMM-K85

For [3GPP Release](#) = "LTE-Advanced/eMTC" UEs, sets the number of antenna ports used for every SRS transmission.

"Max. Number of Antenna Ports for PUSCH"	1	2	4
"Number of Antenna Ports for SRS"	1, 2, 4	1, 2	1, 4

Remote command:

```
[ :SOURce<hw> ] :BB:EUTRa:UL:UE<st> [ :CELL<ccidx> ] :REFSig:
SRS [<srsidx> ] :NAPort on page 764
```

SRS Cyclic Shift n_CS (First AP) ← SRS Set Configuration

Sets the cyclic shift n_{CS} used for the generation of the sounding reference signal CAZAC sequence for the first port. The n_{cs} for the other ports are calculated automatically; they have a fixed relation to the first one.

The different shifts of the same Zadoff-Chu sequence are orthogonal to each other. Thus, you can apply different SRS cyclic shifts to schedule different users to transmit simultaneously their sounding reference signal.

Remote command:

```
[ :SOURce<hw> ] :BB:EUTRa:UL:UE<st> [ :CELL<ccidx> ] :REFSig:
SRS [<srsidx> ] :CYCShift on page 765
```

SRS UpPTS Add ← SRS Set Configuration

Option: R&S SMM-K119

In TDD mode, sets the higher layer parameter `srs-UpPtsAdd`, as specified in [TS 36.211](#).

This parameter defines the number of additional SC-FDMA symbols in UpPTS and thus determines the total length of GP and UpPTS.

Remote command:

```
[ :SOURce<hw> ] :BB:EUTRa:UL:UE<st> [ :CELL<ccidx> ] :REFSig:
SRS [<srsidx> ] :UPPTsadd on page 765
```

SRS Structure ← SRS Set Configuration

Use the following parameters to define the SRS structure:

Configuration Index I_{SRS} ← SRS Structure ← SRS Set Configuration

Sets the UE-specific parameter SRS configuration index I_{SRS} .

Depending on the selected "Duplexing Mode", this parameter determines the parameters [SRS Periodicity \$T_{\text{SRS}}\$](#) and [SRS Subframe Offset \$T_{\text{offset}}\$](#) as defined in the TS 36.213, table 8.2-1 (FDD) and 8.2-2 (TDD) respectively.

Remote command:

```
[ :SOURCE<hw> ] :BB:EUTRa:UL:UE<st> [ :CELL<ccid> ] :REFSig:
SRS [<srsidx>] :ISRS on page 767
```

Periodicity T_{SRS} ← SRS Structure ← SRS Set Configuration

Displays the UE-specific parameter SRS periodicity T_{SRS} , i.e. displays the interval of milliseconds after which the SRS is transmitted. The displayed value depends on the selected SRS [Configuration Index \$I_{\text{SRS}}\$](#) and "Duplexing Mode" as defined in the TS 36.213, table 8.2-1 (FDD) and 8.2-2 (TDD) respectively.

Adjust the SRS configuration index to enable more frequent SRS transmission like each 2 ms or an infrequently SRS transmission like each 320 ms for instance.

For TDD duplexing mode, a T_{SRS} of 2 ms means that SRS is transmitted two times in 5 ms.

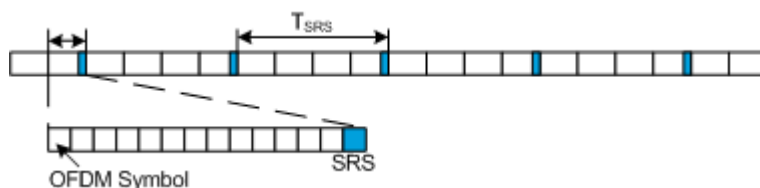

Example:

"Configuration Index = 0", i.e. "Periodicity $T_{SRS} = 2\text{ ms}$ " and "Subframe Offset $T_{offset} = 0$ "

"SRS State > On"

"Duplexing > FDD"

The default values of all other SRS parameters are left unchanged.

The SRS is transmitted every 2 ms and occupies the entire channel bandwidth, i.e. frequency hopping is not enabled.

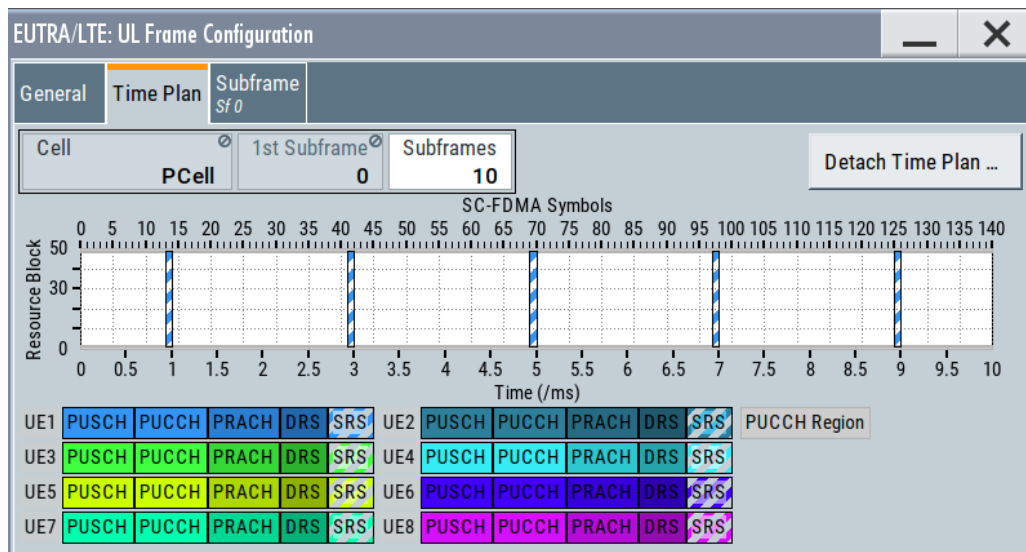

Remote command:

```
[ :SOURCE<hw> ] :BB:EUTRa:UL:UE<st> [ :CELL<ccidx> ] :REFSig:
SRS [<srsidx> ] :TSRS? on page 767
```

Subframe Offset T_{offset} ← SRS Structure ← SRS Set Configuration

Displays the UE-specific parameter SRS subframe offset T_{offset} , depending on the selected SRS Configuration Index I_{SRS} and "Duplexing Mode" as defined in the TS 36.213, table 8.2-1 (FDD) and 8.2-2 (TDD).

An SRS subframe offset shifts the SRS pattern. While SRS periodicity T_{SRS} remains constant, the SRS transmission is delayed with period of time equal to the SRS subframe offset T_{offset} .

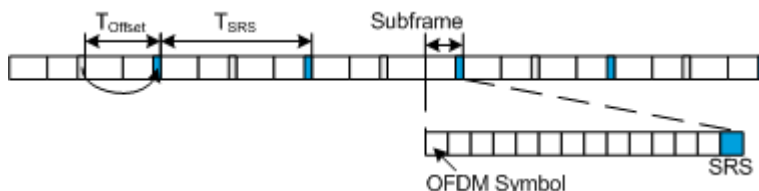

Example:

- "Configuration Index = 1", i.e. "Periodicity $T_{\text{SRS}} = 2 \text{ ms}$ " and "Subframe Offset $T_{\text{offset}} = 1$ "
- "SRS State > On"
- "Duplexing > FDD"

The default values of all other SRS parameters are left unchanged.

The SRS is transmitted every 2 ms and occupies the entire channel bandwidth, i.e. frequency hopping is not enabled. Compared to the SRS transmission with $T_{\text{offset}} = 0$, the SRS transmission is delayed with 1 ms.

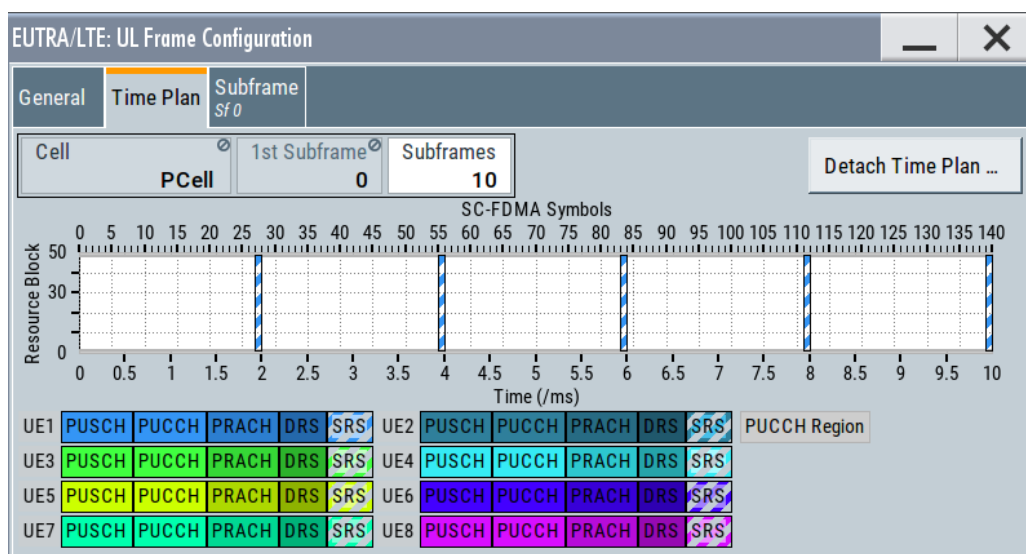

For TDD duplexing mode, a T_{offset} of 0 or 5 means that SRS is transmitted in the second last symbol of the special subframe (in the UpPTS part). For this case, adjust the parameter **TDD Special Subframe Config** so that an UpPTS field length of two symbols is assured.

For TDD duplexing mode with T_{SRS} value of 2 ms, two T_{offset} values are displayed, corresponding to the two SRS transmissions per 5 ms. For example, the values 0, 1 mean that two SRS transmissions occur, both in the special subframe. One of them is in the second last symbol and the other one, in the last symbol of the subframe.

Remote command:

```
[ :SOURCE<hw> ] :BB:EUTRA:UL:UE<st> [ :CELL<ccid> ] :REFSig:
SRS [ <srsidx> ] :TOFFset? on page 768
```

SRS Bandwidth B_{SRS} ← SRS Structure ← SRS Set Configuration

Sets the bandwidth covered by a single SRS transmission. That is the UE-specific parameter SRS bandwidth B_{SRS} , as defined in the **TS 36.211**, chapter 5.5.3.2.

The SRS can span the entire frequency bandwidth or use frequency hopping where several narrowband SRSs cover the same total bandwidth.

There are 4 SRS bandwidths defined in the standard. The most narrow SRS bandwidth ($B_{SRS} = 3$) spans 4 resource blocks and is available for all channel bandwidths. The other 3 values of the parameter B_{SRS} define more wideband SRS bandwidths, available depending on the channel bandwidth.

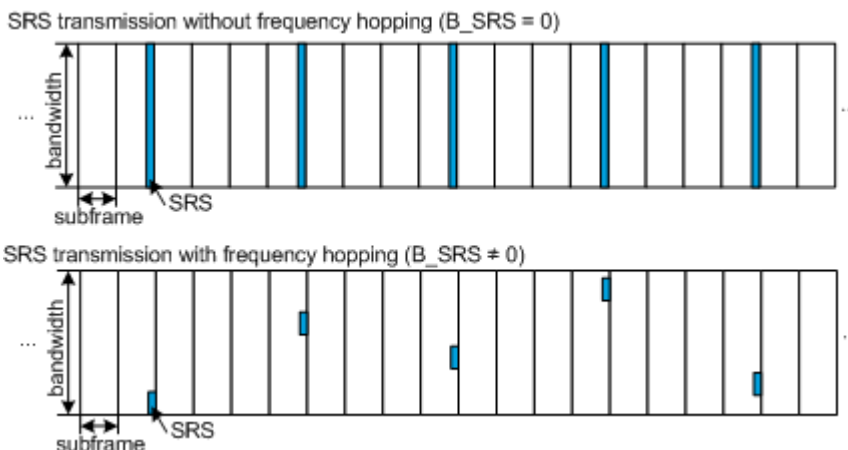

The SRS transmission bandwidth is determined also by the "SRS Bandwidth Configuration C_{SRS} ".

Example:

"SRS State > On"

"Duplexing > FDD"

The default values of all other SRS parameters are left unchanged.

For " $B_{SRS} = 0$ ", the SC-FDMA time plan shows a wideband SRS without frequency hopping.

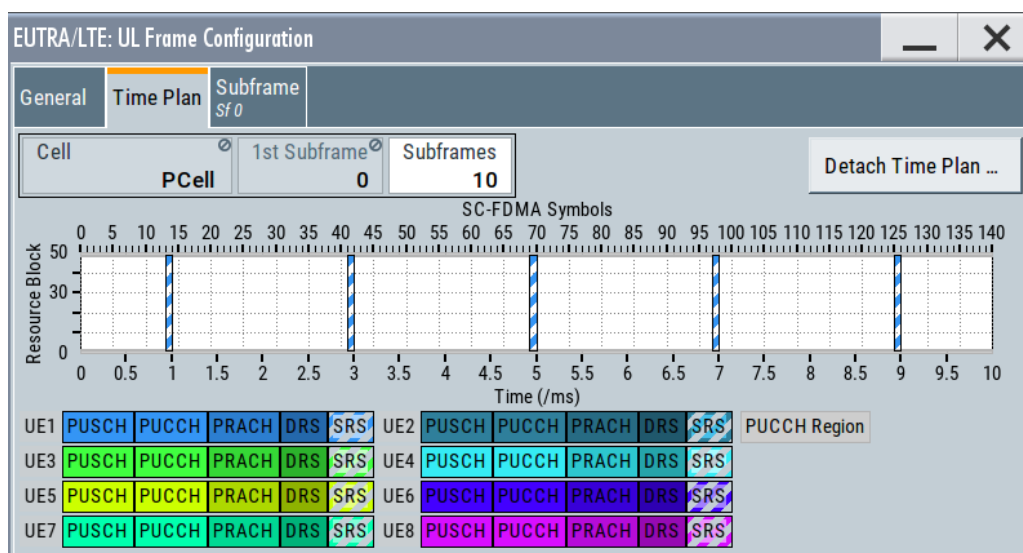

Changing the SRS bandwidth to " $B_{SRS} = 3$ " results in the most narrowband SRS transmission with SRS bandwidth of 4 RBs and enabled frequency hopping.

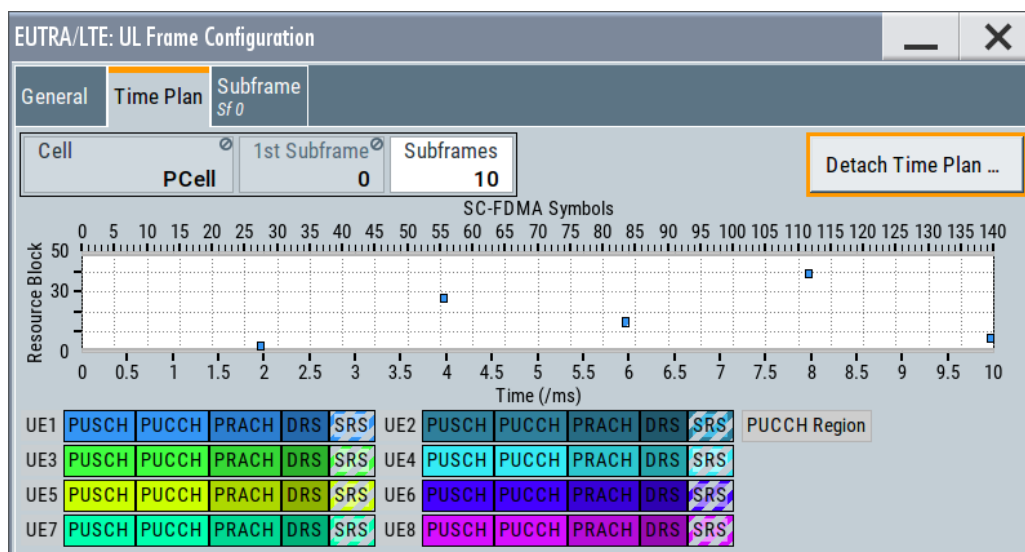

Remote command:

```
[ :SOURCE<hw> ] :BB:EUTRa:UL:UE<st> [ :CELL<ccidx> ] :REFSig:
SRS [ <srsidx> ] :BSRS on page 766
```

Transmission Comb Num k TC ← SRS Structure ← SRS Set Configuration

Option: R&S SMM-K119

In TDD mode, sets the UE-specific parameter number of combs (transmissionCombNum), as defined in the TS 36.211.

Remote command:

```
[ :SOURCE<hw> ] :BB:EUTRa:UL:UE<st> [ :CELL<ccidx> ] :REFSig:
SRS [ <srsidx> ] :NKTC on page 768
```

Transmission Comb k TC ← SRS Structure ← SRS Set Configuration

Sets the UE-specific parameter transmission comb parameter k_{TC} , as defined in the TS 36.211, chapter 5.5.3.2.

The SRS is transmitted on alternating subcarriers, where with $k_{TC} = 1$ every odd and with $k_{TC} = 0$ every even subcarrier is used.

Remote command:

```
[ :SOURCE<hw> ] :BB:EUTRa:UL:UE<st> [ :CELL<ccidx> ] :REFSig:
SRS [ <srsidx> ] :TRComb on page 768
```

Hopping Bandwidth b_hop ← SRS Structure ← SRS Set Configuration

(for trigger type 0 SRS ("Type 0"))

Sets the UE-specific parameter frequency hopping bandwidth b_{hop} , as defined in the TS 36.211, chapter 5.5.3.2.

SRS frequency hopping is enabled, if $b_{HOP} < B_{SRS}$. Hopping bandwidth is the frequency band in that the SRS hops.

Remote command:

```
[ :SOURCE<hw> ] :BB:EUTRa:UL:UE<st> [ :CELL<ccidx> ] :REFSig:SRS:BHOP
on page 766
```

Freq. Domain Position n_{RRC} ← SRS Structure ← SRS Set Configuration

Sets the UE-specific parameter `freqDomainPositionnRRC`, as defined in the TS 36.211, chapter 5.5.3.2.

This parameter determines the starting physical resource block of the SRS transmission.

Remote command:

```
[ :SOURCE<hw> ] :BB:EUTRa:UL:UE<st> [ :CELL<ccid> ] :REFSig:
SRS [<srsidx> ] :NRRC on page 769
```

Number of Transmissions ← SRS Structure ← SRS Set Configuration

Sets the number of SRS transmissions.

That is, the number of cells in the table [Subframes for Transmission](#).

Remote command:

```
[ :SOURCE<hw> ] :BB:EUTRa:UL:UE<st> [ :CELL<ccid> ] :REFSig:
SRS [<srsidx> ] :NTRans on page 765
```

Subframes for Transmission ← SRS Structure ← SRS Set Configuration

Sets the subframes in that the SRS is transmitted. The values correspond to the values of the SRS parameter [Configuration Index I_{SRS}](#).

A conflict is indicated in the following situations:

- The subframe number is already used in the SRS set
- The subframe number is used in another SRS set of the same UE

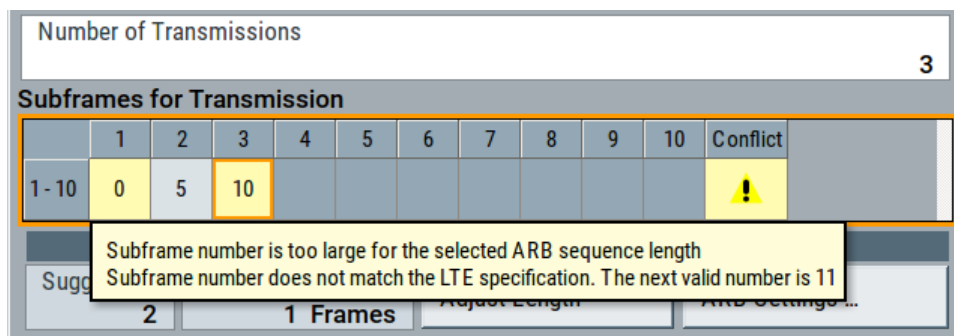

Figure 4-14: Example of conflict indication: DCI 4 Set 2 and DCI 1A/2B/2C/2D SRS sets use configuration index (subframe number) = 2

- The subframe number is outside the current ARB sequence length.

Note: If there is conflict, observe the tooltip.

Change the subframe index or select [Adjust Length](#) to set the "ARB Sequence Length" to the proposed value.

Remote command:

```
[ :SOURCE<hw> ] :BB:EUTRa:UL:UE<st> [ :CELL<ccid> ] :REFSig:
SRS [<srsidx> ] :SUBF<subfid> on page 766
```

Suggested ← SRS Structure ← SRS Set Configuration

Indicates the suggest ARB sequence length as number of frames.

Select "Adjust Length" to set the ARB sequence length to the proposed value.

Adjust Length ← SRS Structure ← SRS Set Configuration

Set the ARB sequence length to the proposed value.

This function is active, if an SRS transmission is configured in subframe number that is outside of the frames in the current "ARB Sequence Length".

ARB Settings ← SRS Structure ← SRS Set Configuration

Access the "ARB" dialog and displays the "ARB Sequence Length" value.

See [Chapter 9.2.3, "ARB settings"](#), on page 538.

4.8.7 Sidelink settings

- D2D communication and discovery modes
Option: R&S SMM-K113
- V2X communication mode
Option: R&S SMM-K119

Access:

1. Select "General > Link Direction > Uplink (SC-FDMA)".
2. Select "General > General UL Settings > Cell" > "Cyclic Prefix = Normal or Extended".
3. Select "Frame Configuration > General > Select User Equipment > UEx".
4. Select "Sidelink".
5. Open the "Time Plan" to observe the configuration.

• Common sidelink settings	278
• Resource pool control and resource pool settings	280
• Resource pool data settings	286
• RMC settings	290
• Synchronization settings	291
• SCI configuration settings	293
• SCI format configuration	296
• Allocation settings	299
• PSCCH, PSDCH and PSSCH enhanced settings	302

4.8.7.1 Common sidelink settings

Access:

1. Select "General > Link Direction > Uplink (SC-FDMA)".
2. Select "Frame Configuration > General > Select User Equipment > UEx".

3. Select "User Equipment Configuration > Sidelink > Common".

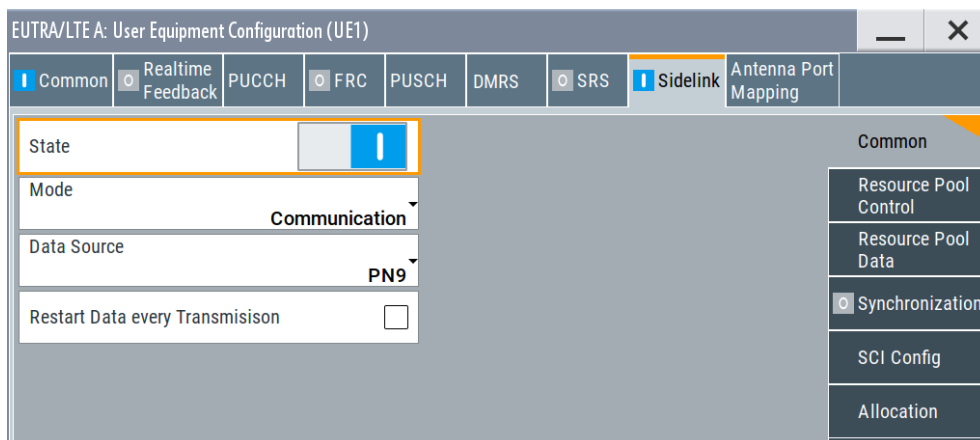

With the provided settings, you can select the mode in that the sidelink is working.

State.....	279
Mode.....	279
Data Source.....	279
Restart Data every Transmission.....	280

State

Enables transmission of the sidelink.

Remote command:

[:SOURce<hw>] :BB:EUTRa:UL:UE<st>:SL:STATe on page 777

Mode

Sets the mode of the sidelink communication.

Remote command:

[:SOURce<hw>] :BB:EUTRa:UL:UE<st>:SL:MODE on page 777

Data Source

Selects the sidelink data source.

The following standard data sources are available:

- "All 0, All 1"
An internally generated sequence containing 0 data or 1 data.
- "PNxx"
An internally generated pseudo-random noise sequence.
- "Pattern"
An internally generated sequence according to a bit pattern.
Use the "Pattern" box to define the bit pattern.
- "Data List/Select DList"
A binary data from a data list, internally or externally generated.
Select "Select DList" to access the standard "Select List" dialog.
 - Select the "Select Data List > navigate to the list file *.dm_iqd > Select" to select an existing data list.

- Use the "New" and "Edit" functions to create internally new data list or to edit an existing one.
- Use the standard "File Manager" function to transfer external data lists to the instrument.

See also:

- Section "Modulation Data" in the R&S SMM100A user manual.
- Section "File and Data Management" in the R&S SMM100A user manual.
- Section "Data List Editor" in the R&S SMM100A user manual

Remote command:

[:SOURce<hw>] :BB:EUTRa:UL:UE<st>:SL:DATA on page 778

[:SOURce<hw>] :BB:EUTRa:UL:UE<st>:SL:DSElect on page 778

[:SOURce<hw>] :BB:EUTRa:UL:UE<st>:SL:PATtern on page 778

Restart Data every Transmission

If enabled, the data source is restarted at each SL transmission.

Remote command:

[:SOURce<hw>] :BB:EUTRa:UL:UE<st>:SL:REStart on page 778

4.8.7.2 Resource pool control and resource pool settings

Access:

1. Select "General > Link Direction > Uplink (SC-FDMA)".
2. Select "Frame Configuration > General > Select User Equipment > UEx".
3. Select "User Equipment Configuration > Sidelink > Common > Mode > Communication".
4. Select "Sidelink > Resource Pool Control".

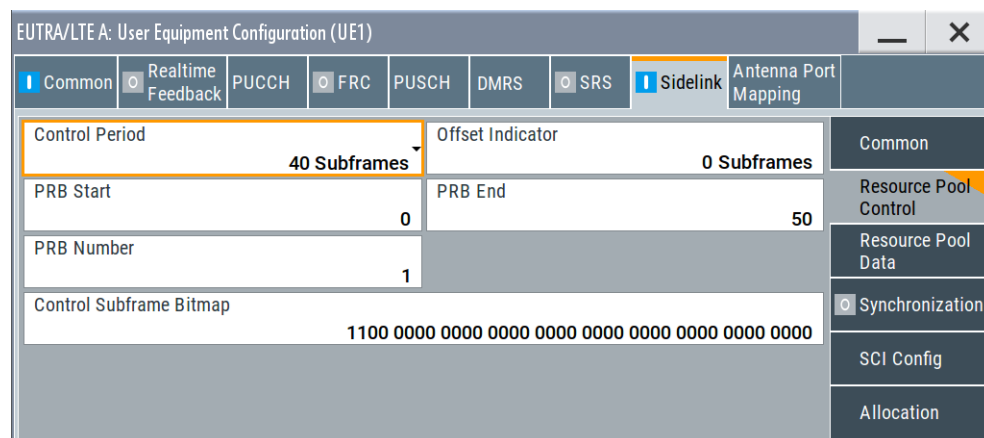

5. Select "Sidelink > Common > Mode > Discovery".
Select "Sidelink > Resource Pool".

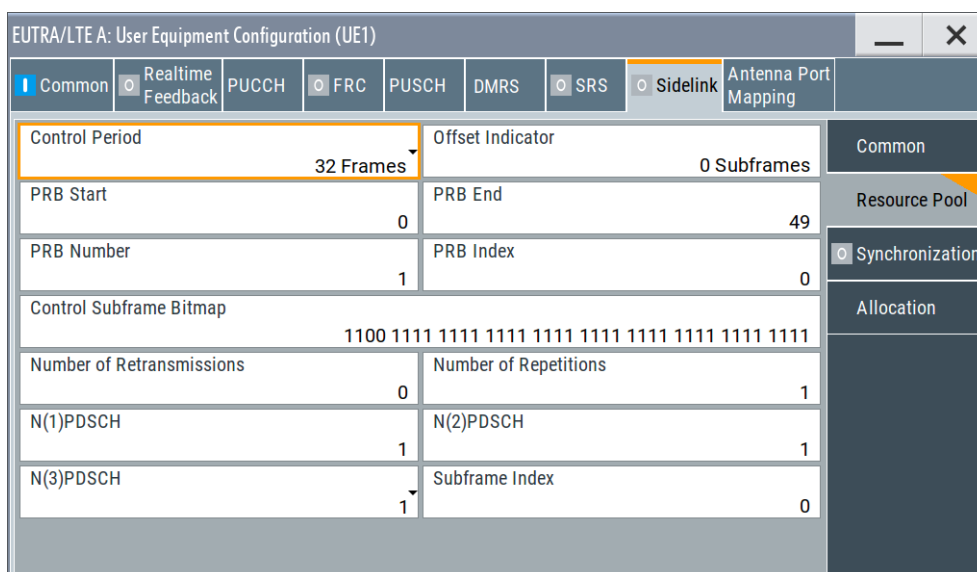

6. Select "Sidelink > Common > Mode > V2X Communication".
Select "Sidelink > Resource Pool".

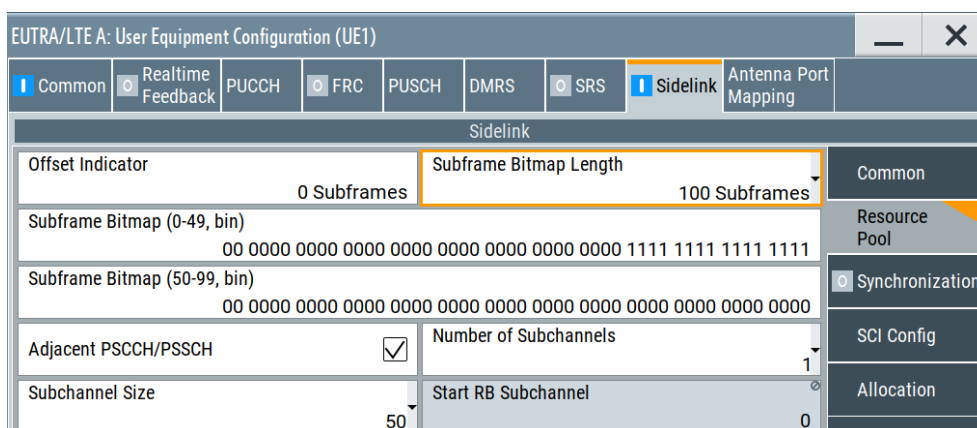

The provided settings depend on the selected SL mode. For "Mode = Communication", for example, you can configure the resource pool for the sidelink control region.

Here, you can define the resource blocks reserved for sidelink transmission by setting the three parameters **PRB Start**, **PRB End** and **PRB Number**.

- Control Period..... 282
- Offset Indicator..... 282
- PRB Start, PRB End..... 283
- PRB Number..... 283
- Control Subframe Bitmap/Subframe Bitmap..... 283
- Resource pool (RP) settings dedicated to the discovery mode..... 284
 - L Number of Retransmission..... 284
 - L Number of Repetitions..... 284
 - L N(1)PDSCH/N(2)PDSCH/N(3)PDSCH..... 284
 - L Subframe Index..... 284

- L PRB Index.....284
- Resource pool (RP) settings dedicated to the V2X communication mode.....285
 - L Subframe Bitmap Length..... 285
 - L Subframe Bitmap (0-49, bin)/Subframe Bitmap (50-99, bin).....285
 - L Adjacent PSCCH/PSSCH.....286
 - L Number of Subchannels..... 286
 - L Subchannel Size.....286
 - L Start RB Subchannel..... 286

Control Period

For "Sidelink > Common > Mode > Discovery/Communication", sets the period over which resources are allocated for sidelink control period (SC period).

Depending on the "Sidelink > Common > Mode", this parameter sets one of the parameters listed in Table 4-14. As shown in the table, the SL communication is based on equal-sized PSCCH periods, with period length depending on the duplexing mode.

Table 4-14: Value range depending on the duplexing mode and the SL mode

"Sidelink > Common > Mode"	Parameter according to TS 36.331	Duplexing	TDD UL/DL configuration	Control period
Communication	SL-CommResourcePool	FDD	-	40, 80, 160, 320 subframes
		TDD	0	70, 140, 280 subframes
			1 to 5	40, 80, 160, 320 subframes
			6	60, 120, 240 subframes
Discovery	discPeriod	-	-	32, 64, 128, 256, 512, 1024 frames

Remote command:

```
[ :SOURCE<hw> ] :BB:EUTRa:UL:UE<st>:SL:RCTRl:CPERiod on page 779
[ :SOURCE<hw> ] :BB:EUTRa:UL:UE<st>:SL:RDISc:CPERiod on page 779
```

Offset Indicator

Sets the parameter SL-OffsetIndicator, i.e. the offset from the SFN=0 after that the SL control region starts and thus defines the starting subframe of the repeating subframe bitmap (Control Subframe Bitmap/Subframe Bitmap)

If "Control Period Offset = 0", then the first subframe of the resource pool starts from the first subframe of SFN = 0.

"User Equipment Configuration > Sidelink > Common > Mode"	Value range
Communication V2X communication	0 to 319
Discovery	0 to 10239

Remote command:

```
[ :SOURCE<hw> ] :BB:EUTRa:UL:UE<st>:SL:RCTRl:OFFSetind on page 779
[ :SOURCE<hw> ] :BB:EUTRa:UL:UE<st>:SL:RDISc:OFFSetind on page 779
[ :SOURCE<hw> ] :BB:EUTRa:UL:UE<st>:SL:V2X:OFFSet on page 779
```

PRB Start, PRB End

For "Sidelink > Common > Mode > Communication/Discovery", sets the parameters `prb-Start` and `prb-End` and define allocation of the two SL bands. The two bands occupy equal bandwidth, that is set in terms of resource blocks by the parameter `prb-Num`, see [PRB Number](#).

The default values for the "PRB Start" and "PRB End" depend on the selected "Channel Bandwidth".

Remote command:

`[:SOURCE<hw>] :BB:EUTRa:UL:UE<st>:SL:RCTRl:PRBStart` on page 780

`[:SOURCE<hw>] :BB:EUTRa:UL:UE<st>:SL:RCTRl:PRENd` on page 780

`[:SOURCE<hw>] :BB:EUTRa:UL:UE<st>:SL:RDISc:PRBStart` on page 780

`[:SOURCE<hw>] :BB:EUTRa:UL:UE<st>:SL:RDISc:PRENd` on page 780

PRB Number

For "Sidelink > Common > Mode > Communication/Discovery", sets the parameter `prb-Num` and defines the number of resource blocks each of the SL bands occupies.

The SL transmission is allowed on set of resources (subframes and resource blocks) called resource pool. If a subframe is used or not for SL transmission is defined by the subframe bitmap.

Within a subframe allowed for SL transmission, the resources used for SL are divided into two bands, where the first one starts at the `prb-Start` and the second ends at the `prb-End`. Each of the two bands occupies a `prb-Num` resource blocks.

Remote command:

`[:SOURCE<hw>] :BB:EUTRa:UL:UE<st>:SL:RCTRl:PRBNumber` on page 780

`[:SOURCE<hw>] :BB:EUTRa:UL:UE<st>:SL:RDISc:PRBNumber` on page 780

Control Subframe Bitmap/Subframe Bitmap

Sets the subframe bitmap (`SubframeBitmapSL`) and thus defines which subframes are allowed for SL transmission (PSCCH).

The bitmap is a sequence of bits and has different length depending on the duplexing mode. The bitmap must contain at least two bits set to 1, because the PSCCH transmission occurs in two subframes.

The bit value indication is as follows:

- 1: indicates subframes used for PSCCH transmission
- The last 1: indicates the the beginning of the PSSCH transmission
- 0: indicates subframes used for PSSCH transmission.

Table 4-15: Bitmap length range depending on the duplexing mode for Mode > Communication/Discovery

Duplexing	TDD UL/DL configuration	Bitmap length, bits
FDD	-	40
TDD	0	42
	1	16
	2	8
	3	12

Duplexing	TDD UL/DL configuration	Bitmap length, bits
	4	8
	5	4
	6	30

Remote command:

[:SOURce<hw>] :BB:EUTRa:UL:UE<st>:SL:RCTR1:SFBMp on page 780

[:SOURce<hw>] :BB:EUTRa:UL:UE<st>:SL:RDISc:SFBMp on page 780

Resource pool (RP) settings dedicated to the discovery mode

Access: select "Sidelink > Common > Mode > Discovery" and "Sidelink > Resource Pool".

Number of Retransmission ← Resource pool (RP) settings dedicated to the discovery mode

Sets the parameter `numRetx` and defines how many times the PSDCH is retransmitted while working in discovery mode. The PDSCH comprises of 232 transport blocks.

Remote command:

[:SOURce<hw>] :BB:EUTRa:UL:UE<st>:SL:RDISc:NRETrans on page 781

Number of Repetitions ← Resource pool (RP) settings dedicated to the discovery mode

Sets the parameter `numRepetition` and defines how many times the PSDCH is repeated.

Remote command:

[:SOURce<hw>] :BB:EUTRa:UL:UE<st>:SL:RDISc:NREPetitions on page 781

N(1)PDSCH/N(2)PDSCH/N(3)PDSCH ← Resource pool (RP) settings dedicated to the discovery mode

Sets the PDSCH resource index.

Remote command:

[:SOURce<hw>] :BB:EUTRa:UL:UE<st>:SL:RDISc:N1PDsch on page 781

[:SOURce<hw>] :BB:EUTRa:UL:UE<st>:SL:RDISc:N2PDsch on page 782

[:SOURce<hw>] :BB:EUTRa:UL:UE<st>:SL:RDISc:N3PDsch on page 782

Subframe Index ← Resource pool (RP) settings dedicated to the discovery mode

Sets the subframe index `discSF-Index` as defined in TS 36.331.

Remote command:

[:SOURce<hw>] :BB:EUTRa:UL:UE<st>:SL:RDISc:SFIndex on page 784

PRB Index ← Resource pool (RP) settings dedicated to the discovery mode

Sets the physical resource block index `discPRB-Index` as defined in TS 36.331.

Remote command:

[:SOURce<hw>] :BB:EUTRa:UL:UE<st>:SL:RDISc:PRIndex on page 785

Resource pool (RP) settings dedicated to the V2X communication mode

Option: R&S SMM-K119

The V2X communication mode commonly describes the three scenarios:

- V2V: vehicle-to-vehicle operation
- V2P: vehicle-to-pedestrian operation
- V2I: vehicle-to-network/infrastructure operation.

The V2X communication reuses the resource grid of the SL transmission. The resource pools are defined by the parameters:

- RPStart ([Start RB Subchannel](#))
- NubSubchannels ([Number of Subchannels](#))
- SizeSubchannels ([Subchannel Size](#)).

Subframe Bitmap Length ← Resource pool (RP) settings dedicated to the V2X communication mode

For "Sidelink > Common > Mode > V2X Communication", set the bitmap length.

Table 4-16: Value range depending on the duplexing mode and the SL mode

"Sidelink > Common > Mode"	Duplexing	TDD UL/DL configuration	Control period, subframes
V2X communication	FDD	-	16, 20, 100
	TDD	0	60
		1	40
		2, 4	20
		3	30
		5	10
		6	50

Remote command:

`[:SOURCE<hw>] :BB:EUTRa:UL:UE<st>:SL:V2X:BMPLength` on page 782**Subframe Bitmap (0-49, bin)/Subframe Bitmap (50-99, bin) ← Resource pool (RP) settings dedicated to the V2X communication mode**Sets the subframe bitmap (`SubframeBitmapSL`) and thus defines which subframes are allowed for SL transmission (PSCCH).The bitmap is a sequence of bits and has different length depending as selected with the parameter [Subframe Bitmap Length](#).The "Subframe Bitmap (50-99, bin)" is enabled, if "Subframe Bitmap Length \geq 60 Subframes".

Remote command:

`[:SOURCE<hw>] :BB:EUTRa:UL:UE<st>:SL:V2X:BITLow` on page 782`[:SOURCE<hw>] :BB:EUTRa:UL:UE<st>:SL:V2X:BITHigh` on page 783

Adjacent PSCCH/PSSCH ← Resource pool (RP) settings dedicated to the V2X communication mode

If enabled, the PSCCH and PSSCH channels are allocated on contiguous resources, where the PSCCH is allocated at the lower end of the subchannel.

If "Number of Subchannels > 1", the PSCCH is transmitted in the subchannel as set with the parameter [Subchannel](#).

Remote command:

[:SOURCE<hw>] :BB:EUTRa:UL:UE<st>:SL:V2X:ADJC on page 783

Number of Subchannels ← Resource pool (RP) settings dedicated to the V2X communication mode

Sets the number of subchannels.

Remote command:

[:SOURCE<hw>] :BB:EUTRa:UL:UE<st>:SL:V2X:SUBChannels on page 784

Subchannel Size ← Resource pool (RP) settings dedicated to the V2X communication mode

Sets the number of resource blocks the subchannel spans.

The allowed value depends on whether "Adjacent PSCCH/PSSCH" are used or not.

The value is also limited by the constraint: "Subchannel Size"*"Number of Subchannels" ≤ N_RB, where N_RB is the number of resource blocks depending on the selected "Channel Bandwidth".

Remote command:

[:SOURCE<hw>] :BB:EUTRa:UL:UE<st>:SL:V2X:SUBSize on page 784

Start RB Subchannel ← Resource pool (RP) settings dedicated to the V2X communication mode

Sets the first RB in the subchannel.

Remote command:

[:SOURCE<hw>] :BB:EUTRa:UL:UE<st>:SL:V2X:SRBSubchan on page 784

4.8.7.3 Resource pool data settings

Access:

1. Select "General > Link Direction > Uplink (SC-FDMA)".
2. Select "Frame Configuration > General > Select User Equipment > UEx".
3. Select "User Equipment Configuration > Common > 3GPP Release > LTE-Advanced".
4. Select "Sidelink > Common > Mode" > "**Communication**".

5. Select "Sidelink > Resource Pool Data".

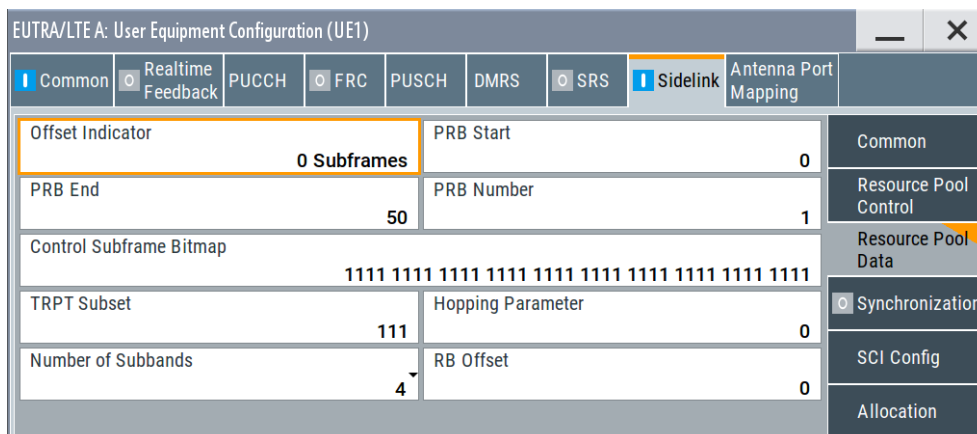

With the provided settings, you can configure the resource pool (RP) for the side-link data region.

The data region starts directly after the last bit of the [Control Subframe Bitmap](#)(SubframeBitmapSL) which is set to 1. The data region itself contains a bitmap, the TRTP bitmap ([TRPT Subset](#)). The latter indicates the subframes which are used for the data transmission. The TRTP bitmap is repeated until the end of the SC period is reached.

Two types of resource pools are defined, the reception resource pool (Rx RP) and the transmission resource pool (Tx RP).

Offset Indicator	287
PRB Start, PRB End	288
PRB Number	288
Control Subframe Bitmap	288
TRPT Subset	289
Hopping Parameter	289
Number of Subbands	289
RB Offset	289

Offset Indicator

Sets the parameter *SL-OffsetIndicator*, i.e. the offset from the SFN=0 after that the SL control region starts and thus defines the starting subframe of the repeating subframe bitmap ([Control Subframe Bitmap](#)).

If "Control Period Offset = 0", then the first subframe of the resource pool starts from the first subframe of SFN = 0.

"User Equipment Configuration > Sidelink > Common > Mode"	Value range
Communication	0 to 319
Discovery	0 to10240

Remote command:

[\[:SOURCE<hw>\]:BB:EUTRA:UL:UE<st>:SL:RDATa:OFFSetind](#) on page 779

PRB Start, PRB End

Sets the parameters `prb-Start` and `prb-End` and define allocation of the two SL bands. The two bands occupy equal bandwidth, that is set in terms of resource blocks by the parameter `PRB-Num`.

The default values for the "PRB Start" and "PRB End" depend on the selected "Channel Bandwidth".

Remote command:

`[:SOURCE<hw>] :BB:EUTRa:UL:UE<st>:SL:RDATa:PRBStart` on page 780

`[:SOURCE<hw>] :BB:EUTRa:UL:UE<st>:SL:RDATa:PRENd` on page 780

PRB Number

Sets the parameter `prb-Num` and defines the number of resource blocks each of the SL bands occupies.

The SL transmission is allowed on set of resources (subframes and resource blocks) called resource pool. Whether a subframe is used or not for SL transmission is defined by the subframe bitmap.

Within a subframe allowed for SL transmission, the resources used for SL are divided into two bands, where the first one starts at the `prb-Start` and the second ends at the `prb-End`. Each of the two bands occupies a `prb-Num` resource blocks.

Remote command:

`[:SOURCE<hw>] :BB:EUTRa:UL:UE<st>:SL:RDATa:PRBNumber` on page 780

Control Subframe Bitmap

Sets the subframe bitmap (`SubframeBitmapSL`) and thus defines which subframes are allowed for SL transmission (PSCCH).

The bitmap is a sequence of bits and has different length depending on the duplexing mode. The bitmap must contain at least two bits set to 1, because the PSCCH transmission occurs in two subframes.

The bit value indication is as follows:

- 1: indicates subframes used for PSCCH transmission
- The last 1: indicates the the beginning of the PSSCH transmission
- 0: indicates subframes used for PSSCH transmission.

Table 4-17: Bitmap length range depending on the duplexing mode

Duplexing	TDD UL/DL configuration	Bitmap length, bits
FDD	-	40
TDD	0	42
	1	16
	2	8
	3	12
	4	8
	5	4
	6	30

Remote command:

[:SOURce<hw>] :BB:EUTRa:UL:UE<st>:SL:RDATa:SFBMp on page 780

TRPT Subset

The TRPT subset is a kind of an additional restriction for PSSCH subframe allocations from the total subframes available for PSSCH transmission. The TRPT subset is a time resources pattern that indicates the set of available subframes to be used for sidelink communication. If the TRPT subset is not signaled, the UE assumes that the whole TRPT set is available.

The TRPT bitmap is repeated until the end of the SC period is reached.

Table 4-18: TRPT subset length depending on the duplexing mode

Duplexing	TDD UL/DL configuration	TRTP subset length, bits
FDD	-	3
TDD	0	5
	1	3
	2	3
	3	4
	4	3
	5	3
	6	4

Remote command:

[:SOURce<hw>] :BB:EUTRa:UL:UE<st>:SL:RDATa:TRPTsubset on page 785

Hopping Parameter

Sets the frequency hopping parameter.

Remote command:

[:SOURce<hw>] :BB:EUTRa:UL:UE<st>:SL:RDATa:HOPpingparam on page 785

Number of Subbands

Sets the number of subbands. The SL transmission can use 1, 2 or 4 subbands.

Remote command:

[:SOURce<hw>] :BB:EUTRa:UL:UE<st>:SL:RDATa:NSUBbands on page 785

RB Offset

Shifts the band in the frequency domain by the selected number of resource blocks (RB).

Table 4-19: Value range depending on the bandwidth

Bandwidth	RB offset
1.4 MHz	0 to 4
3 MHz	0 to 12
5 MHz	0 to 22

Bandwidth	RB offset
10 MHz	0 to 48
15 MHz	0 to 72
20 MHz	0 to 98

Remote command:

[:SOURce<hw>] :BB:EUTRa:UL:UE<st>:SL:RDATa:RBOffset on page 786

4.8.7.4 RMC settings

Access:

1. Select "General > Link Direction > Uplink (SC-FDMA)".
2. Select "Frame Configuration > General > Select User Equipment > UEx".
3. Select "User Equipment Configuration > Common > 3GPP Release > LTE-Advanced".
4. Select "Sidelink > Common > Mode" > "**V2X Communication**".
5. Select "Sidelink > RMC".

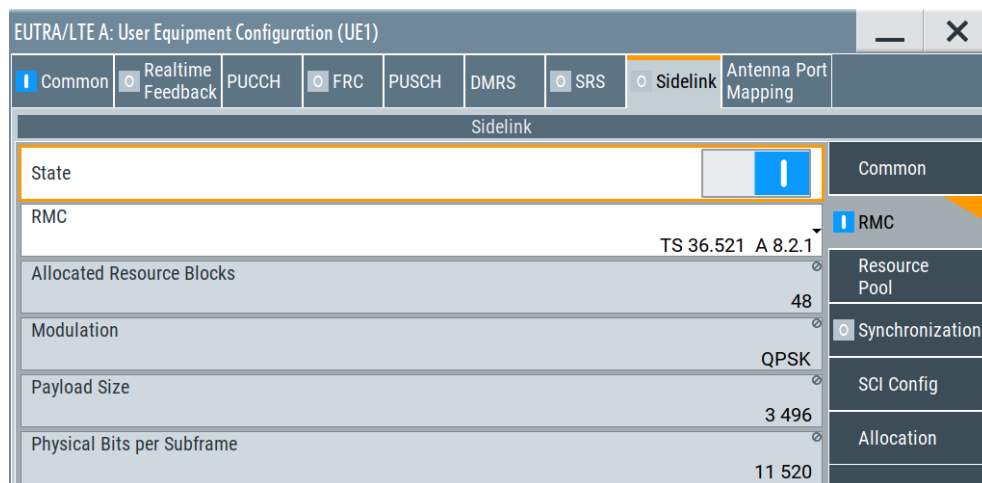

With the provided settings, you can select a preconfigured reference measurement channel (RMC).

State.....	291
RMC.....	291
Allocated Resource Blocks.....	291
Modulation.....	291
Payload Size.....	291
Physical Bits per Subframe.....	291

State

If enabled, the settings according to the selected reference measurement channel (RMC) are applied.

Remote command:

[:SOURce<hw>] :BB:EUTRa:UL:UE<st>:SL:RMC:STATe on page 797

RMC

Selects one of the predefined reference measurement channels.

All further settings in this dialog are set automatically.

Remote command:

[:SOURce<hw>] :BB:EUTRa:UL:UE<st>:SL:RMC:RMC on page 797

Allocated Resource Blocks

Indicates the number of resource blocks the allocation spans.

Remote command:

[:SOURce<hw>] :BB:EUTRa:UL:UE<st>:SL:RMC:ARBLocks? on page 798

Modulation

Indicates the used modulation scheme.

Remote command:

[:SOURce<hw>] :BB:EUTRa:UL:UE<st>:SL:RMC:MODulation? on page 798

Payload Size

Indicates the payload size.

Remote command:

[:SOURce<hw>] :BB:EUTRa:UL:UE<st>:SL:RMC:PAYSize? on page 798

Physical Bits per Subframe

indicates the number of used physical bits per subframe

Remote command:

[:SOURce<hw>] :BB:EUTRa:UL:UE<st>:SL:RMC:PHYSbits? on page 798

4.8.7.5 Synchronization settings

Access:

1. Select "General > Link Direction > Uplink (SC-FDMA)".
2. Select "Frame Configuration > General > Select User Equipment > UEx".
3. Select "User Equipment Configuration > Common > 3GPP Release > LTE-Advanced".

4. Select "Sideline > Synchronization".

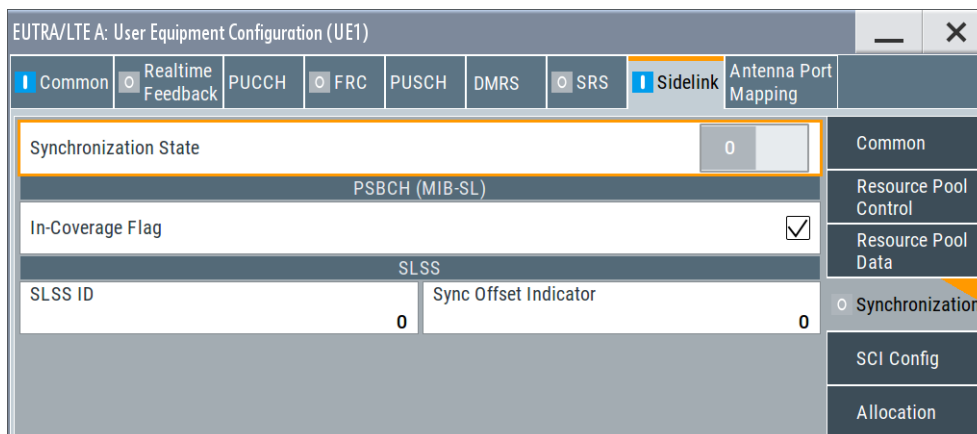

The dialog comprises the settings of the sidelink synchronization signal (SLSS) and the sidelink common control information, carried by a single message on the PSBCH (physical sidelink broadcast channel).

Depending on the SL "Sideline > Common" > **Mode**, this single message is:

- Option: R&S SMM-K113
The master information block-SL (MIB-SL) message for sidelink discovery and sidelink communication
- Option: R&S SMM-K119
The master information block-SL-V2X (MIB-SL-V2X) message for V2X sidelink communication.

The MIB-SL transmission on a fixed schedule with a periodicity of 40 ms and without repetitions, where the subframes in that the MIB-SL is scheduled are defined by the parameter "**Sync Offset Indicator**" on page 293.

The MIB-SL-V2X is also transmitted on a fixed schedule but it uses a periodicity of 160 ms without repetitions.

Synchronization State..... 292

PSBCH (MIB-SL)..... 292

 L In-coverage Flag..... 293

SLSS..... 293

 L SLSS ID..... 293

 L Sync Offset Indicator..... 293

Synchronization State

Enables using the two types of synchronization signals for the SL transmission:

- Sidelink synchronization signals (SLSS) used for synchronization in time and frequency
- Master information block SL (MIB-SL) that provides additional information.

Remote command:

[:SOURce<hw>] :BB:EUTRa:UL:UE<st>:SL:SYNC:STATe on page 786

PSBCH (MIB-SL)

The MIB-SL is one of the SL synchronization signals. It is transmitted over the PBCCH and carries the following information:

In-coverage Flag ← PSBCH (MIB-SL)

Sets the parameter `inCoverage` according to TS 36.331. It indicates whether the sender is in the coverage of a cell or not.

Remote command:

`[:SOURCE<hw>] :BB:EUTRa:UL:UE<st>:SL:SYNC:INCoverage` on page 786

SLSS

There are primary and secondary SL synchronization signals (SLSSs), the PSSS and the SSSS. Each of the synchronization signals spans 62 resource elements, located around the center carrier. In the time domain, the SLSS span two subsequent symbols.

The SLSS is additionally defined by the following parameters:

SLSS ID ← SLSS

Sets the SLSS ID form that the receiving UE detects if the transmitting UE is in coverage of at least if it receives its synchronization from the LTE cell.

Remote command:

`[:SOURCE<hw>] :BB:EUTRa:UL:UE<st>:SL:SYNC:SLSSid` on page 787

Sync Offset Indicator ← SLSS

Sets the parameter `syncOffsetIndicator` according to TS 36.331 that defines the subframes in that the MIB-SL is scheduled.

Remote command:

`[:SOURCE<hw>] :BB:EUTRa:UL:UE<st>:SL:SYNC:OFFSetind` on page 787

4.8.7.6 SCI configuration settings

Access:

1. Select "General > Link Direction > Uplink (SC-FDMA)".
2. Select "Frame Configuration > General > Select User Equipment > UEx".
3. Select "User Equipment Configuration > Common > 3GPP Release > LTE-Advanced".
4. Select "Sidelink > Common > Mode > Communication".
Or "Sidelink > Common > Mode > V2X Communication"

5. Select "Sidelink > SCI Config".

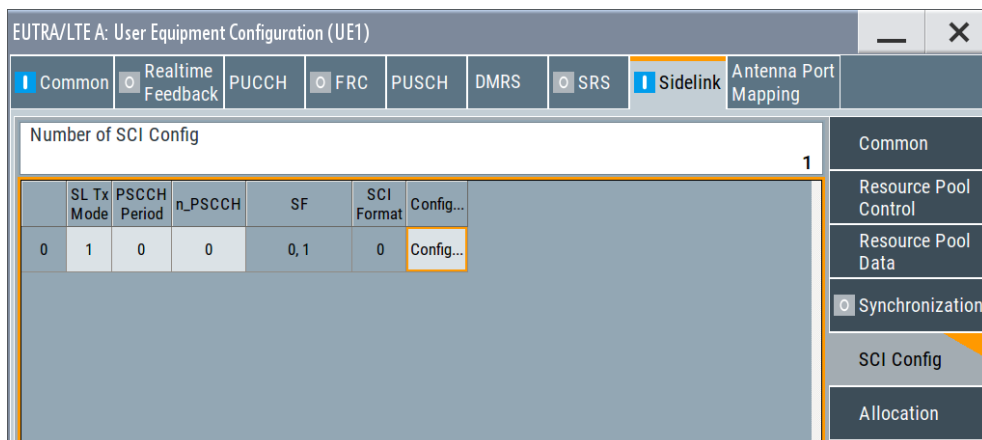

With the provided settings, you can configure the number of SCI (SL control information) configurations, the SCI format and the content of the SCI.

Number of SCI Config..... 294

SCI Table..... 294

- L SL Tx Mode..... 294
- L PSCCH Period..... 295
- L n_PSCCH..... 295
- L Start SF..... 295
- L Subchannel..... 295
- L SF..... 295
- L SCI Format..... 296
- L Config..... 296

Number of SCI Config

Sets the number of SCI (SL control information) configurations. In the SCI table, there is one table row per SCI configuration.

Remote command:

```
[ :SOURce<hw> ] :BB:EUTRa:UL:UE<st>:SL:NSCI on page 787
```

SCI Table

In the SCI table, there is one table row per SCI configuration.

SL Tx Mode ← SCI Table

Sets the transmission mode of the SL transmission.

The Tx mode defines how the resources from a resource pool (RP) are assigned and influence the start of the data part.

- "1" (Mode 1) The resource assignment, incl. the resources within an RP is indicated by the eNB.
- "2" (Mode 2) The UE uses a set of predefined pools and selects the resources thereof.

"3", "4" (Mode 3 and 4) Option: R&S SMM-K119
Set the transmission mode for "Sidelink > Common > Mode > V2X Communication".

Remote command:

[:SOURCE<hw>] :BB:EUTRa:UL:UE<st>:SL:SCI<ch0>:TXMode on page 787

PSCCH Period ← SCI Table

For "Sidelink > Common > Mode > Communication", the subframes used for SL transmissions are distributed over different PSCCH periods. The PSCCH period is defined with the parameter "Resource Pool Control" > [Control Period](#).

This parameter defines the PSCCH period in that the SCI configuration is performed.

Remote command:

[:SOURCE<hw>] :BB:EUTRa:UL:UE<st>:SL:SCI<ch0>:PSCPeriod on page 788

n_PSCCH ← SCI Table

For "Sidelink > Common > Mode > Communication", sets the parameter n_PSCCH and determines the resources in the time and the frequency domain that a transmitting UE uses for the PSCCH transmission.

Remote command:

[:SOURCE<hw>] :BB:EUTRa:UL:UE<st>:SL:SCI<ch0>:NPSCch on page 788

Start SF ← SCI Table

Option: R&S SMM-K119

For "Sidelink > Common > Mode > V2X Communication", sets the first subframe used for the SL transmission, where the starting SF of the subsequent configuration has to be greater than the period of the previous one.

Remote command:

[:SOURCE<hw>] :BB:EUTRa:UL:UE<st>:SL:SCI<ch0>:STARTsf on page 789

Subchannel ← SCI Table

Option: R&S SMM-K119

For "Sidelink > Common > Mode > V2X Communication", sets the used subchannel.

The number of subchannels is set with the parameter [Number of Subchannels](#).

Remote command:

[:SOURCE<hw>] :BB:EUTRa:UL:UE<st>:SL:SCI<ch0>:SUBChannel
on page 789

SF ← SCI Table

Indicates the subframe numbers of the subframes that can be used for SL transmission. The values are calculated automatically.

- In "Sidelink > Common > Mode > Communication/Discovery" mode, the PSCCH allocation uses two subframes.
- In "Sidelink > Common > Mode > V2X Communication" mode, the PSCCH allocation uses one or 2 subframes.

Remote command:

[:SOURCE<hw>] :BB:EUTRa:UL:UE<st>:SL:SCI<ch0>:SF? on page 788

SCI Format ← SCI Table

Sets the SCI (SL control information) format.

- "0" SCI format 0, required for "Sidelink > Common" > **Mode** = "Communication"
- "1" Option: R&S SMM-K119
SCI format 1, required for V2X transmission ("Sidelink > Common" > **Mode** = "V2X Communication").

Remote command:

[:SOURCE<hw>] :BB:EUTRa:UL:UE<st>:SL:SCI<ch0>:FORMat on page 788

Config ← SCI Table

Opens a dialog with further settings to configure the content of the SCI with the selected format, see [Chapter 4.8.7.7, "SCI format configuration"](#), on page 296.

4.8.7.7 SCI format configuration

Access:

1. Select "General > Link Direction > Uplink (SC-FDMA)".
2. Select "Frame Configuration > General > Select User Equipment > UEx".
3. Select "User Equipment Configuration > Common > 3GPP Release > LTE-Advanced".
4. Select "Sidelink > Common > Mode > Communication".
Or "Sidelink > Common > Mode > V2X Communication"
5. Select "Sidelink > SCI Config > SCI Format = e.g. 0".
6. Select "Config".

In this dialog, you configure the content of the SCI (SL control information) in the selected format ("Sidelink > SCI Config" > **SCI Format**).

The SCI carries information from that the receiving device detects the PSSCH and retrieves information on the set of resources in which the PSSCH is transmitted.

Settings:

Bit Data	296
SCI Format 0	297
SCI Format 1	298

Bit Data

Displays the resulting bit data as selected with the SCI format parameters.

Mapping of the information bits is according to [TS 36.212](#).

Remote command:

[:SOURCE<hw>] :BB:EUTRa:UL:UE<st>:SL:SCI<ch0>:BITData? on page 789

SCI Format 0

The SCI format 0 is defined for SL transmission in communication mode ("Sidelink > Common > Mode > Communication").

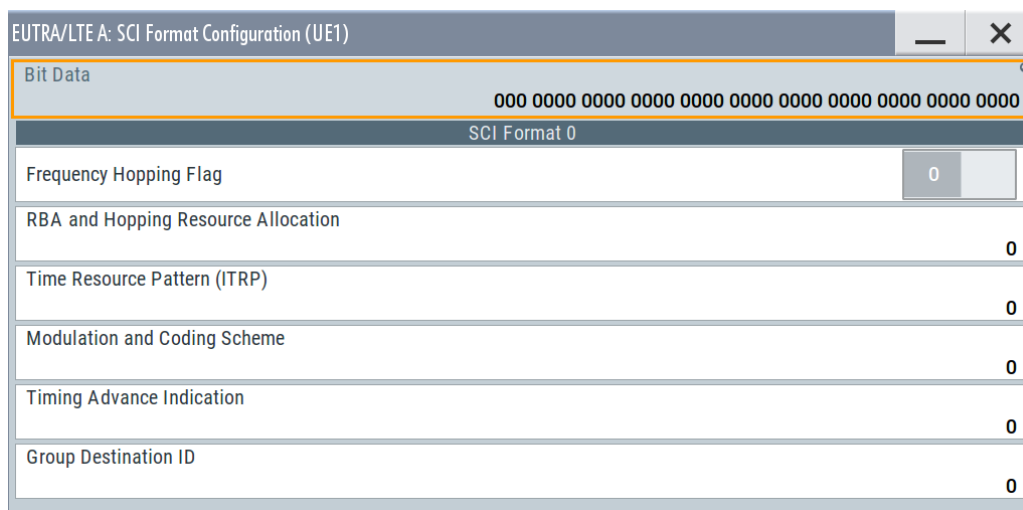

The fields defined in the SCI format are mapped to the information bits according to the 3GPP specification and the resulting "Bit Data" on page 296 is displayed.

The bit data length depends on the "Channel Bandwidth" and the value of the SCI parameter "RBA and Hopping Resource Allocation".

"Channel Bandwidth", MHz	Number of bits in the "Bit Data" field
1.4	37
3	39
5	41
10	43
15	44
20	45

Control information field	SCPI command	Dependencies
"Frequency Hopping Flag"	[:SOURCE<hw>] :BB:EUTRa:UL:UE<st>:SL:SCI<ch0>: FHFLag on page 790	
"RBA and Hopping Resource Allocation"	[:SOURCE<hw>] :BB:EUTRa:UL:UE<st>:SL:SCI<ch0>: RBAHoppalloc on page 790	Value range depends on the "Channel Bandwidth"

Control information field	SCPI command	Dependencies
"Time Resource Pattern (ITPR)"	[:SOURCE<hw>] :BB:EUTRa:UL:UE<st>:SL:SCI<ch0>: TRP on page 790	Value range for "SL Tx Mode = 1" <ul style="list-style-type: none"> For FDD and "TDD Config = 1, 2, 4, and 5": 0 to 106 For "TDD Config = 0": 1 to 127 For "TDD Config = 3 and 6": 1 to 63 For "SL Tx Mode = 2", automatically set.
"Modulation and Coding Scheme"	[:SOURCE<hw>] :BB:EUTRa:UL:UE<st>:SL:SCI<ch0>: MCS on page 790	
"Timing Advance"	[:SOURCE<hw>] :BB:EUTRa:UL:UE<st>:SL:SCI<ch0>: TAINd on page 791	For "SL Tx Mode = 1": 0 to 2047 For "SL Tx Mode = 2": 0
"Group Destination ID"	[:SOURCE<hw>] :BB:EUTRa:UL:UE<st>:SL:SCI<ch0>: GRID on page 791	

SCI Format 1

Option: R&S SMM-K119

The SCI format 1 is defined for SL transmission in V2X communication mode ("Sidelink > Common > Mode > V2X Communication").

The fields defined in the SCI format are mapped to the information bits according to the 3GPP specification and the resulting "Bit Data" on page 296 is displayed.

The bit data is 32 bits long; filling zeros are appended in case the resulting bit data is shorter than 32 bits.

Control information field	SCPI command	Dependencies
"Priority"	[:SOURCE<hw>] :BB:EUTRa:UL:UE<st>:SL:SCI<ch0>: PRIRity on page 791	
"Resource Reservation"	[:SOURCE<hw>] :BB:EUTRa:UL:UE<st>:SL:SCI<ch0>: RREServation on page 792	Value range: <ul style="list-style-type: none"> For "Tx Mode = 3": 0 For "Tx Mode = 4": 0 to 12

Control information field	SCPI command	Dependencies
"Frequency Resource Location of initial Tx and ReTx"	[:SOURCE<hw>] :BB:EUTRa:UL:UE<st>:SL:SCI<ch0>: FREQresloc on page 791	Length in bits and value range depends on the "Number of Sub-channels": <ul style="list-style-type: none"> • 1: 0 bits • 3: 3 bits [0 to 7] • 5: 4 bits [0 to 15] • 8: 6 bits [0 to 63] • 10: 6 bits [0 to 63] • 15: 7 bits [0 to 127] • 20: 8 bits [0 to 255] • For TDD config = 0: 0 to 127 • For TDD config = 3 and 6: 1 to 63 For "SL Tx Mode = 2", automatically set.
"Time Gap between initial Tx and ReTx"	[:SOURCE<hw>] :BB:EUTRa:UL:UE<st>:SL:SCI<ch0>: TIMGap on page 792	
"Modulation and Coding Scheme"	[:SOURCE<hw>] :BB:EUTRa:UL:UE<st>:SL:SCI<ch0>: MCS on page 790	
"Retransmission Index"	[:SOURCE<hw>] :BB:EUTRa:UL:UE<st>:SL:SCI<ch0>: TXINDEX on page 792	

4.8.7.8 Allocation settings

Access:

1. Select "General > Link Direction > Uplink (SC-FDMA)".
2. Select "Frame Configuration > General > Select User Equipment > UEx".
3. Select "User Equipment Configuration > Common > 3GPP Release > LTE-Advanced".
4. Select "Sidelink > Common > Mode > Communication".
Or "Sidelink > Common > Mode > V2X Communication"
5. Select "Sidelink > Allocation".

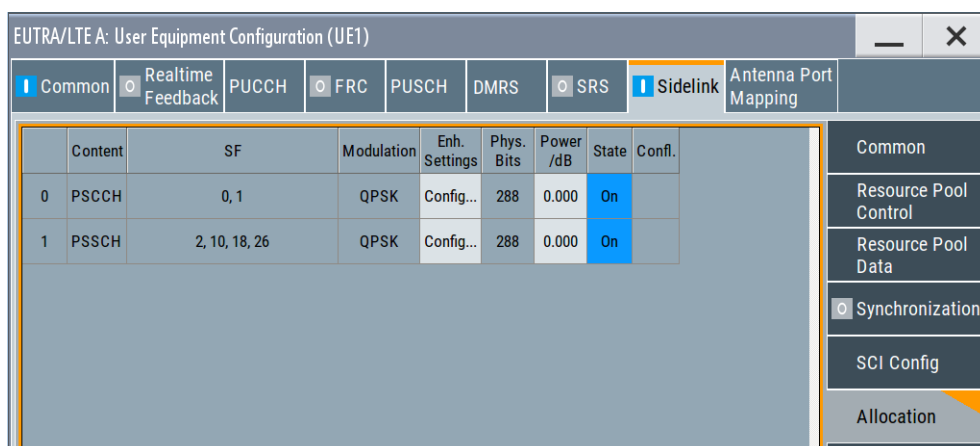

The number of channels is set automatically, depending on the number of SCIs, the SCI format and its content.

6. Select "Sidelink > Common > Mode > Discovery".
Select "Sidelink > Allocation".

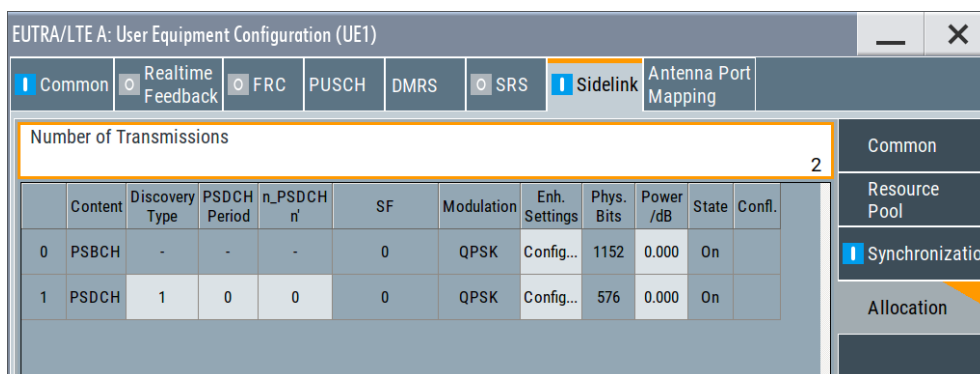

With the provided settings, you can configure the SL allocations. The provided settings depend on the selected SL mode.

- Number of Transmissions..... 300
- Content.....301
- Discovery Type.....301
- PSDCH Period..... 301
- n_PSDCH/n'..... 301
- SF.....301
- Modulation.....302
- Enhanced Settings > Config.....302
- Physical Bits.....302
- Power.....302
- State.....302
- Conflict.....302

Number of Transmissions

For "Sidelink > Common > Mode > Discovery", sets the number of transmissions.

The value defines the number of rows in the allocation table.

Remote command:

[:SOURce<hw>] :BB:EUTRa:UL:UE<st>:SL:NALLoc on page 792

Content

Indicates allocation content, i.e. selects the channel to be transmitted:

- PSCCH: physical sidelink control channel
- PSDCH: physical sidelink discovery channel
- PSSCH: physical sidelink shared channel

Remote command:

[:SOURce<hw>] :BB:EUTRa:UL:UE<st>:SL:ALLoc<ch0>:CONTent?

on page 793

Discovery Type

For "Sidelink > Common > Mode > Discovery" and "Content = PSDCH", selects one of the discovery types, type 1 or type 2B.

Remote command:

[:SOURce<hw>] :BB:EUTRa:UL:UE<st>:SL:ALLoc<ch0>:DISCtype

on page 793

PSDCH Period

For "Sidelink > Common > Mode > Discovery" and "Content = PSDCH", sets the period of the PSDCH, where the period of the subsequent channel has to be greater than the period of the previous one.

Remote command:

[:SOURce<hw>] :BB:EUTRa:UL:UE<st>:SL:ALLoc<ch0>:PSDPeriod

on page 793

n_PSDCH/n'

For "Sidelink > Common > Mode > Discovery" and "Content = PSDCH", sets the parameter n_PSDCH or n' as defined in TS 36.213, where n_PSDCH applies for discovery type 1 and n' - for discovery type 2B.

Value range depends on the selected [Discovery Type](#) and the resource pool configuration.

Remote command:

[:SOURce<hw>] :BB:EUTRa:UL:UE<st>:SL:ALLoc<ch0>:NPDSch on page 794

SF

Indicates the subframe numbers of the allocated subframe. The values are calculated automatically.

The PSCCH is transmitted over 2 subframes, whereas the PSSCH over 4.

The PSDCH transmission depends on the [Number of Retransmission](#) defined in the resource pool.

For "Sidelink > Common > Mode > V2X Communication", the subframes depend on the value of the [SCI Format 1](#) > "Time Gap between initial Tx and ReTx".

Remote command:

[:SOURce<hw>] :BB:EUTRa:UL:UE<st>:SL:ALLoc<ch0>:SF? on page 794

Modulation

Indicates or sets the used modulation, depending on the selected channel type ("Content").

- PSCCH: QPSK
- PSDCH: QPSK
- PSSCH: QPSK, 16QAM

In addition, 64QAM is supported with R&S SMM-K119.

Remote command:

`[:SOURCE<hw>] :BB:EUTRa:UL:UE<st>:SL:ALLoc<ch0>:MODulation?`

on page 794

Enhanced Settings > Config

Opens a dialog with further settings for the selected channel.

Physical Bits

Indicates the number of physical bits occupied by the channel.

Remote command:

`[:SOURCE<hw>] :BB:EUTRa:UL:UE<st>:SL:ALLoc<ch0>:PHYSbits?`

on page 794

Power

Sets the power of the selected channel.

The value is set relative to the UE power.

Remote command:

`[:SOURCE<hw>] :BB:EUTRa:UL:UE<st>:SL:ALLoc<ch0>:POWer` on page 795

State

Enables the transmission of the selected channel.

Remote command:

`[:SOURCE<hw>] :BB:EUTRa:UL:UE<st>:SL:ALLoc<ch0>:STATe` on page 795

Conflict

A conflict is indicated if two allocations overlap.

Remote command:

`[:SOURCE<hw>] :BB:EUTRa:UL:UE<st>:SL:ALLoc<ch0>:CONFLict?`

on page 795

4.8.7.9 PSCCH, PSDCH and PSSCH enhanced settings

Access:

1. Select "General > Link Direction > Uplink (SC-FDMA)".
2. Select "Frame Configuration > General > Select User Equipment > UEx".
3. Select "User Equipment Configuration > Common > 3GPP Release > LTE-Advanced".

4. Select "Sidelink > Common > Mode > Communication".
Or "Sidelink > Common > Mode > V2X Communication"
5. Select "Sidelink > Allocation > Enhanced Settings > Config".

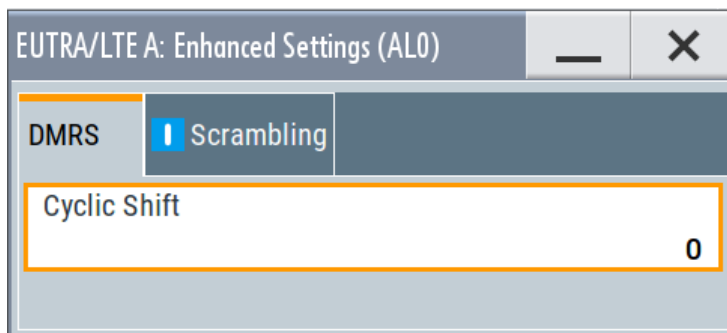

6. Select "Enhanced Settings > Scrambling".

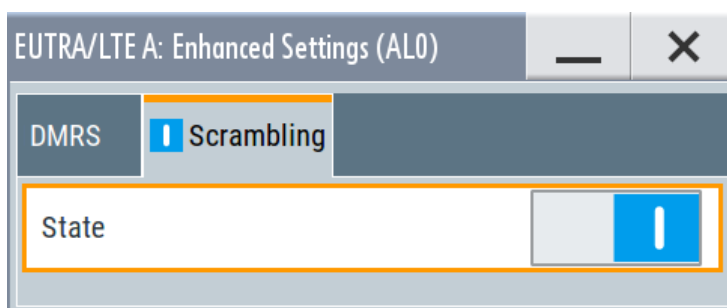

With the provided settings, you can configure the channel coding and scrambling settings of the selected channel.

DMRS > Cyclic Shift.....	303
Scrambling.....	304
L State.....	304
Channel coding.....	304
L State.....	304
L Number of Physical Bits.....	304
L Transport Block Index.....	304
L Transport Block Size.....	304

DMRS > Cyclic Shift

Sets the cyclic shift used by the generation of the DMRS (demodulation reference signal) sequence.

For "Sidelink > Common > Mode > Communication/Discovery", the value for PSCCH is fixed to "Cyclic Shift = 0".

For "Sidelink > Common > Mode > V2X Communication", the value for PSCCH is one of the following {0, 3, 6, 9}.

Remote command:

```
[ :SOURce<hw> ] :BB:EUTRa:UL:UE<st>:SL:ALLoc<ch0>:CYCShift
```

on page 796

Scrambling

Comprises the scrambling settings:

State ← Scrambling

Enables scrambling.

Remote command:

`[:SOURCE<hw>] :BB:EUTRa:UL:UE<st>:SL:ALLoc<ch0>:SCRambling:STATE`
on page 796

Channel coding

Access: select "Sideline > Allocation > Content > PSSCH" and select "Enhanced Settings > Config".

State ← Channel coding

Enables channel coding.

Remote command:

`[:SOURCE<hw>] :BB:EUTRa:UL:UE<st>:SL:ALLoc<ch0>:CCODing:STATE`
on page 796

Number of Physical Bits ← Channel coding

Indicates the resulting number of physical bits.

Remote command:

`[:SOURCE<hw>] :BB:EUTRa:UL:UE<st>:SL:ALLoc<ch0>:PHYSbits?`
on page 794

Transport Block Index ← Channel coding

Indicates the resulting transport block index.

Remote command:

`[:SOURCE<hw>] :BB:EUTRa:UL:UE<st>:SL:ALLoc<ch0>:CCODing:TBSI?`
on page 796

Transport Block Size ← Channel coding

Indicates the resulting transport block size.

Remote command:

`[:SOURCE<hw>] :BB:EUTRa:UL:UE<st>:SL:ALLoc<ch0>:CCODing:TBSize?`
on page 797

4.8.8 Antenna port mapping

Option: R&S SMM-K85

Access:

1. Select "General > Link Direction > Uplink (SC-FDMA)".
2. Select "Frame Configuration > General > Select User Equipment > UEx".

3. Select "User Equipment Configuration > Common > 3GPP Release > LTE-Advanced".
4. Select "Antenna Port Mapping".

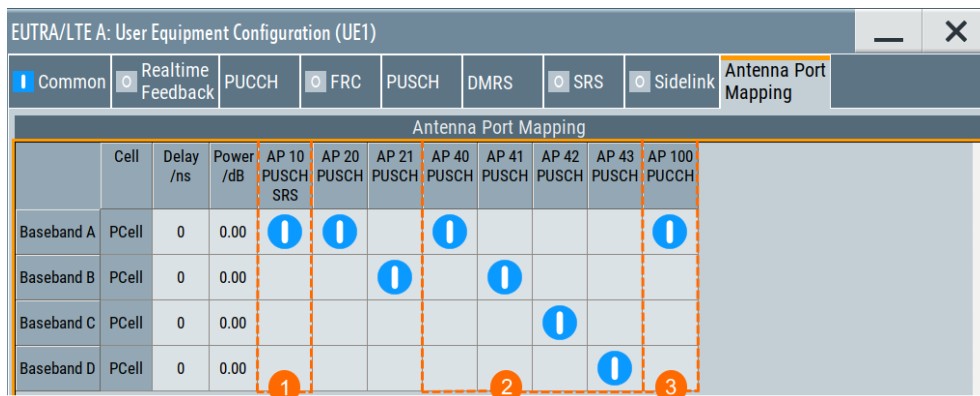

Figure 4-15: Antenna port mapping setting in "System Configuration > Fading/Baseband Configuration > Advanced", 4xN MIMO and "BB Source > Coupled"

- 1 = Number of AP for PUSCH/SRS = 1
- 2 = Number of AP for PUSCH/SRS = 4
- 2 = Number of AP for PUCCH = 1
- 2 = Number of AP for PUCCH = 2

The "Antenna Port Mapping" settings define which baseband generates which antenna port.

Settings:

Cell..... 305
 Power..... 305
 Antenna port mapping table..... 305

Cell

Indicates the cell (primary cell or secondary cell).

Power

Applies a power offset to the selected PCell or SCell.

Remote command:

[:SOURce<hw>] :BB:EUTRa:UL:UE<st>:CELL<dir0>:POFFset on page 770

Antenna port mapping table

The mapping table is a matrix with the following dimension:

- Number of rows equal to the number of physical Tx antennas (Basebands)
- Number of columns equal of the number of antenna ports (AP).

The available antenna ports depend on:

- Max. Number of AP for PUSCH (tab General)
- Number of Antenna Ports for PUCCH per PUCCH Format
- Number of Antenna Ports for SRS

The [Table 4-20](#) gives an overview of the available antenna port numbers as a function of the enabled "Number of Antenna Ports" per channel/signal.

Table 4-20: Available antenna port numbers

Number of antenna ports	1	2	4
Physical channel/signal			
PUSCH	10	20 21	40 41 42 43
PUCCH	100	200 201	-
SRS	10	20 21	40 41 42 43

Per activated baseband, you can activate exactly one PUSCH, one PUCCH, and one SRS antenna port.

Remote command:

`[:SOURCE<hw>] :BB:EUTRa:UL:UE<st>:APMap:AP10Map:ROW<bbid>`
on page 769

`[:SOURCE<hw>] :BB:EUTRa:UL:UE<st>:APMap:AP20Map:ROW<bbid>`
on page 769

`[:SOURCE<hw>] :BB:EUTRa:UL:UE<st>:APMap:AP21Map:ROW<bbid>`
on page 769

`[:SOURCE<hw>] :BB:EUTRa:UL:UE<st>:APMap:AP40Map:ROW<bbid>`
on page 769

`[:SOURCE<hw>] :BB:EUTRa:UL:UE<st>:APMap:AP41Map:ROW<bbid>`
on page 769

`[:SOURCE<hw>] :BB:EUTRa:UL:UE<st>:APMap:AP42Map:ROW<bbid>`
on page 769

`[:SOURCE<hw>] :BB:EUTRa:UL:UE<st>:APMap:AP43Map:ROW<bbid>`
on page 769

`[:SOURCE<hw>] :BB:EUTRa:UL:UE<st>:APMap:AP100Map:ROW<bbid>`
on page 769

`[:SOURCE<hw>] :BB:EUTRa:UL:UE<st>:APMap:AP200Map:ROW<bbid>`
on page 769

`[:SOURCE<hw>] :BB:EUTRa:UL:UE<st>:APMap:AP201Map:ROW<bbid>`
on page 769

4.8.9 PRACH power ramping

Access:

1. Select "General > Link Direction > Uplink (SC-FDMA)".
2. Select "Frame Configuration > General > Select User Equipment > UEx"
3. Select "Common > Mode > PRACH"

The screenshot shows the 'EUTRA/LTE: User Equipment Configuration (UE1)' dialog box. It has two tabs: 'Common' and 'PRACH'. The 'PRACH' tab is active. The settings are as follows:

- State: [On/Off toggle]
- 3GPP Release: Rel. 8/9
- UE ID/n_RNTI: 0
- UE Power: 0.000 dB
- Mode: PRACH (highlighted with an orange border)
- Restart Data, A/N, CQI and RI every Subframe and Codeword:
- PRACH Power Ramping section:
 - State: 0
 - Transition Time: 20.0 μs

This dialog comprises the settings needed for configuring the PRACH power ramping.

Settings:

State PRACH Power Ramping.....	307
Transition Time.....	307

State PRACH Power Ramping

Activates power ramping for the PRACH preamble. The start and the end of the preamble is cyclically extended and multiplied with a ramping function (\sin^2).

Remote command:

[:SOURCE<hw>] :BB:EUTRa:UL:UE<st>:PRACH:PRState on page 752

Transition Time

Defines the transition time from beginning of the extended preamble to the start of the preamble itself.

Remote command:

[:SOURCE<hw>] :BB:EUTRa:UL:UE<st>:PRACH:PRTT on page 753

4.8.10 PRACH configuration

Access:

1. Select "General > Link Direction > Uplink (SC-FDMA)".
2. Select "Frame Configuration > General > Select User Equipment > UEx"
3. Select "Common" > "**Mode = PRACH**"
4. Select "PRACH".

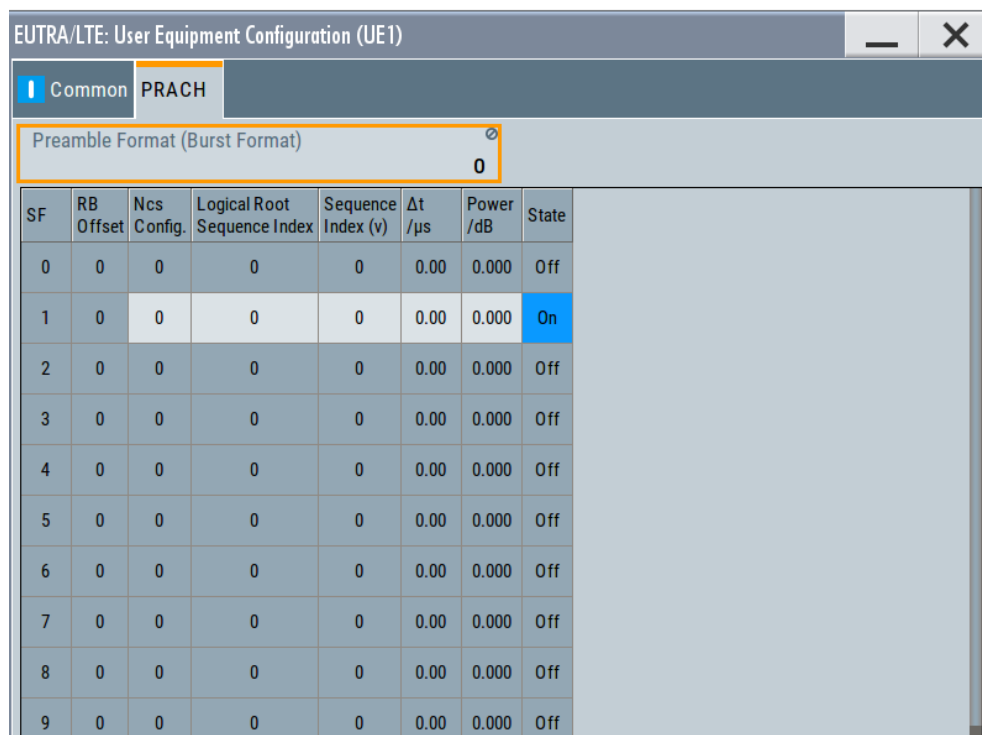

In this dialog, the UE-specific parameters according to TS 36.211 are enabled for configuration.

The cell-specific parameters, necessary for the complete definition of the PRACH, are configurable in the dialog "General UL Settings" > "PRACH".

Settings:

Preamble Format (Burst Format)..... 309

Number of Configurable Frames..... 309

SF..... 309

RB Offset..... 309

Frequency Resource Index..... 309

Ncs Configuration..... 309

Logical Root Sequence Index..... 310

Sequence Index (v)..... 310

Delta t/us.....	310
Power.....	310
State.....	311

Preamble Format (Burst Format)

Displays the preamble format.

The "Preamble Format" is automatically derived from the [PRACH Configuration](#).

Remote command:

[:SOURCE<hw>] :BB:EUTRa:UL:UE<st>:PRACH:PRFormat? on page 753

Number of Configurable Frames

Shows how many frames can be configured.

A maximum number of 20 frames are available for configuration; the currently available number of frames depends on the selected ARB [ARB settings](#).

Remote command:

[:SOURCE<hw>] :BB:EUTRa:UL:UE<st>:PRACH:CFrames? on page 753

SF

Displays the consecutive number of the subframe.

The subframes available for configuration depend on the selected "Duplexing" mode and "PRACH Configuration".

Remote command:

n.a.

RB Offset

Displays the starting RB, as set with the parameter [PRACH Frequency Offset](#).

Remote command:

[:SOURCE<hw>] :BB:EUTRa:UL:UE<st>:PRACH:SUBF<ch0>:RBOffset
on page 754

Frequency Resource Index

This parameter is enabled in TDD duplexing mode only.

Sets the frequency resource index f_{RA} for the selected subframe.

Remote command:

[:SOURCE<hw>] :BB:EUTRa:UL:UE<st>:PRACH:SUBF<ch0>:FRIndex
on page 754

Ncs Configuration

Selects the Ncs configuration of the selected subframe, i.e. determines the Ncs value for the selected preamble set according to [TS 36.211](#), table 5.7.2.-2 and 5.7.2-3.

The value range of this parameter depends on the selected duplexing mode, PRACH configuration and whether a restricted preamble set is enabled or not.

Table 4-21: Value range Ncs configuration

Parameter	Value range
PRACH Restricted Set = "Off"	0 to 15
"Restricted Preamble Set = Type A"	0 to 14
"Restricted Preamble Set = Type B"	0 to 12
TDD + PRACH Configuration > 47	0 to 6

Remote command:

`[:SOURCE<hw>] :BB:EUTRa:UL:UE<st>:PRACH:SUBF<ch0>:NCSConf`
on page 754

Logical Root Sequence Index

Selects the logical root sequence index for the selected subframe.

The value range of this parameter depends on the combination of selected duplexing mode and PRACH configuration.

Parameter	Value range "Logical Root Sequence Index"
TDD + PRACH Configuration > 47 i.e. preamble format 4	0 to 137
All other cases	0 to 837

Remote command:

`[:SOURCE<hw>] :BB:EUTRa:UL:UE<st>:PRACH:SUBF<ch0>:RSEquence`
on page 755

Sequence Index (v)

Selects the sequence index **v** for the selected subframe, i.e. selects which one of the 64 preambles available in a cell is used.

Remote command:

`[:SOURCE<hw>] :BB:EUTRa:UL:UE<st>:PRACH:SUBF<ch0>:SINDEX`
on page 755

Delta t/us

Sets the parameter Delta_t in us.

A value of delta t different than 0 causes a time shift of the configured preamble.

Remote command:

`[:SOURCE<hw>] :BB:EUTRa:UL:UE<st>:PRACH:SUBF<ch0>:DT` on page 755

Power

Sets the PRACH power relative to the UE power. The PRACH power can be adjusted independently for every configured preamble.

Remote command:

`[:SOURCE<hw>] :BB:EUTRa:UL:UE<st>:PRACH:SUBF<ch0>:POWER` on page 754

State

Enables/disables the PRACH for the selected subframe.

The subframes available for configuration depend on the selected PRACH configuration.

Remote command:

[:SOURce<hw>] :BB:EUTRa:UL:UE<st>:PRACH:SUBF<ch0>:STATE on page 756

4.9 Enhanced PUSCH settings

This dialog allows you to define and configure PUSCH parameters, such as the settings of the uplink shared channel (UL-SCH), HARQ control information, and the Channel Quality Control Information (CQI).

Access:

1. Select "General > Link Direction > Uplink (SC-FDMA)".
2. Select "Frame Configuration > Subframe > Content > PUSCH".
3. Select "Enhanced Settings > Configure".

In this dialog you can:

- Define the precoding parameters, see "[Precoding](#)" on page 313
- Enable and configure frequency hopping, see "[Frequency Hopping](#)" on page 313
- Set the cyclic shift used by the demodulation reference signal (DMRS), see [Chapter 4.9.2, "Demodulation reference signal \(DMRS\)"](#), on page 314
- Adjust the parameters for channel coding of the control information (HARQ and CQI), see [Chapter 4.9.3, "Channel coding / multiplexing"](#), on page 315
- Configure the multiplexing of the control information with the data transmission over the UL-SCH

4.9.1 Common PUSCH settings

Access:

1. Select "General > Link Direction > Uplink (SC-FDMA)".
2. Select "Frame Configuration > Subframe > Content > PUSCH".
3. Select "Enhanced Settings > Configure".
4. Select "Frequency Hopping".
5. To enable spatial multiplexing, select "Precoding > Precoding Scheme > Spatial Multiplex".
 - a) Select "Frame Configuration > General > Select User Equipment > UE1... UE4"
 - b) Select "3GPP Release = Release 10"

- c) Select "PUSCH"
- d) Select "Transmission Mode = 2 (Spatial Multiplexing)"
- e) Select "Number of Antenna Ports for PUSCH = 2 or 4"
- f) In the "Enhanced PUSCH Settings" dialog, select "Precoding > Precoding Scheme > Spatial Multiplexing"

The frequency hopping is automatically disabled.

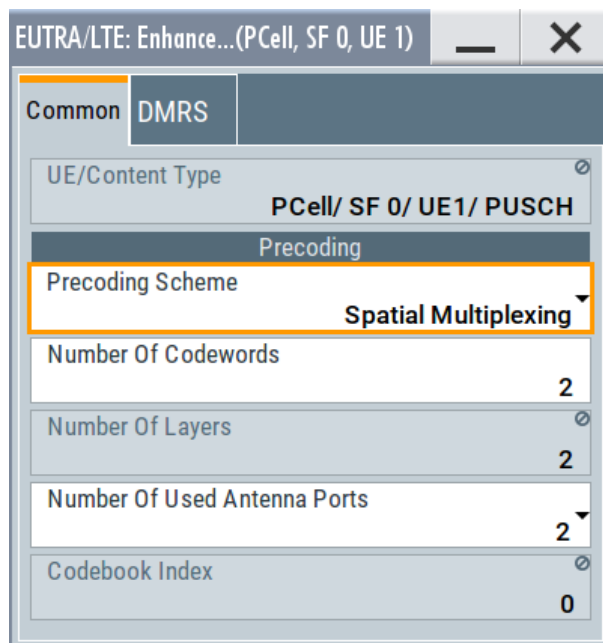

The provided further settings depend on the selected channel coding, see [Chapter 4.9.3, "Channel coding / multiplexing"](#), on page 315.

The common settings comprise the following precoding and frequency hopping settings:

UE/Content Type.....	312
Precoding.....	313
L Precoding Scheme.....	313
L Number of Codewords.....	313
L Number of Layers.....	313
L Number of Used Antenna Port.....	313
L Codebook Index.....	313
Frequency Hopping.....	313
L Frequency Hopping.....	314
L Information in Hopping Bits.....	314
L Hopping Type.....	314

UE/Content Type

Displays the UE number and the content type of the selected allocation.

Remote command:

```
[ :SOURce<hw> ] :BB:EUTRa:UL [ :SUBF<st0> ] :ALLoc<ch0>:CONType
```

on page 703

Precoding

The generation of LTE signals with UL-MIMO is an LTE Rel. 10 feature that requires the additional option R&S SMM-K85 LTE-Advanced.

Precoding Scheme ← Precoding

For [Max. Number of AP for PUSCH \(tab General\)](#) > 1, enables spatial multiplexing for the PUSCH of the current user in the current subframe.

Remote command:

```
[ :SOURCE<hw> ] :BB:EUTRa:UL [ :CELL<ccid> ] [ :SUBF<st0> ] :ALLOc<ch0> :
PUSCh:PRECoding:SCHEME on page 712
```

Number of Codewords ← Precoding

Displays the number of the used codewords.

Remote command:

```
[ :SOURCE<hw> ] :BB:EUTRa:UL [ :CELL<ccid> ] [ :SUBF<st0> ] :ALLOc<ch0> :
PUSCh:CODWords on page 712
```

Number of Layers ← Precoding

Sets the number of layers.

The combination of number of codewords and number of layers determines the layer mapping for the selected precoding scheme, see also [Figure 2-31](#).

Remote command:

```
[ :SOURCE<hw> ] :BB:EUTRa:UL [ :CELL<ccid> ] [ :SUBF<st0> ] :ALLOc<ch0> :
PUSCh:PRECoding:NOLayers on page 712
```

Number of Used Antenna Port ← Precoding

Sets the number of used antenna ports from the number of antenna ports that are configured for PUSCH transmission (see [Max. Number of AP for PUSCH \(tab General\)](#)).

Remote command:

```
[ :SOURCE<hw> ] :BB:EUTRa:UL [ :CELL<ccid> ] [ :SUBF<st0> ] :ALLOc<ch0> :
PUSCh:PRECoding:NAPused on page 713
```

Codebook Index ← Precoding

Sets the codebook index and selects the predefined pre-coder matrix.

The number of available codebook indices depends on the number of used antenna ports.

The combination of the codebook index and the [Number of Layers](#) determines the precoding matrix used for precoding (see also [Figure 2-31](#)).

Remote command:

```
[ :SOURCE<hw> ] :BB:EUTRa:UL [ :CELL<ccid> ] [ :SUBF<st0> ] :ALLOc<ch0> :
PUSCh:PRECoding:CBINDEX on page 713
```

Frequency Hopping

Frequency hopping is applied according to [TS 36.213](#).

Frequency hopping is disabled, if spatial multiplexing is used (see [Precoding Scheme](#)).

Frequency Hopping ← Frequency Hopping

Enables/disables frequency hopping for PUSCH.

Based on the [Information in Hopping Bits](#), a UE performing PUSCH frequency hopping applies one of the two possible [Hopping Type](#).

Remote command:

```
[ :SOURCE<hw> ] :BB:EUTRa:UL [ :CELL<ccidx> ] [ :SUBF<st0> ] :ALLoc<ch0> :
PUSCh:FHOP:STAtE on page 714
```

Information in Hopping Bits ← Frequency Hopping

Sets the information in hopping bits according to the PDCCH DCI format 0 hopping bit definition. This information determines whether type 1 or type 2 hopping is used in the subframe, and - in case of type 1 - also determines the exact hopping function to use.

Remote command:

```
[ :SOURCE<hw> ] :BB:EUTRa:UL [ :CELL<ccidx> ] [ :SUBF<st0> ] :ALLoc<ch0> :
PUSCh:FHOP:IIHBits on page 715
```

Hopping Type ← Frequency Hopping

Displays the frequency hopping type used.

Remote command:

```
[ :SOURCE<hw> ] :BB:EUTRa:UL [ :CELL<ccidx> ] [ :SUBF<st0> ] :ALLoc<ch0> :
PUSCh:FHOP:TYPE? on page 714
```

4.9.2 Demodulation reference signal (DMRS)

Option: R&S SMM-K85

Access:

1. Select "General > Link Direction > Uplink (SC-FDMA)".
2. Select "Frame Configuration > Subframe > Content > PUSCH".
3. Select "Enhanced Settings > Configure".
4. Select "DMRS".

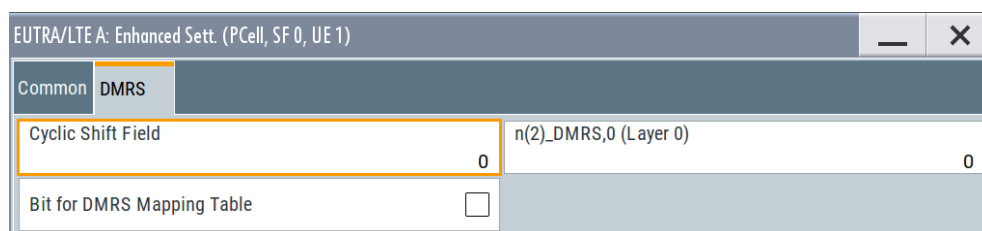
**Cyclic Shift Field**

Cyclic shifts are used to separate the DMRS signals of different users in the time domain. This parameter sets the cyclic shift field in the uplink-related DCI formats, see [Table 4-22](#).

See also "[DCI Format 3/3A](#)" on page 201.

Remote command:

```
[ :SOURCE<hw> ] :BB:EUTRa:UL[ :CELL<ccidx> ] [ :SUBF<st0> ] :ALLoc<ch0> :
PUSCh:DRS:CYCShift on page 715
```

n(2)_DMRS, λ (Layer λ)

Displays the part of the demodulation reference signal (DMRS) index $n_{\text{DMRS}, \lambda}^{(2)}$ per layer, where the number of layers λ is defined with [Number of Layers](#).

Table 4-22: DMRS index $n(2)_{\text{DMRS}, \lambda}$ as function of the cyclic shifts and number of layers λ

Cyclic Shift Field in DCI Formats	$\lambda = 0$ (1 layer)	$\lambda = 1$ (2 layers)	$\lambda = 2$ (3 layers)	$\lambda = 3$ (4 layers)
000	0	6	3	9
001	6	0	9	3
010	3	9	6	0
011	4	10	7	1
100	2	8	5	11
101	8	2	11	5
110	10	4	1	7
111	9	3	0	6

The DMRS index is part of the uplink scheduling assignment and valid for one UE in the subframe. This index applies when multiple shifts within a cell are used and is used by the calculation of the DMRS sequence.

Remote command:

```
[ :SOURCE<hw> ] :BB:EUTRa:UL[ :CELL<ccidx> ] [ :SUBF<st0> ] :ALLoc<ch0> :
PUSCh:DRS:NDMRs<layer>? on page 713
```

Bit for DMRS Mapping Table

Option: R&S SMM-K119

Sets the *Cyclic Shift Field mapping table for DMRS bit* field as defined in [TS 36.211](#) and [TS 36.212](#).

The combination of the two parameters [Enhanced DMRS](#) > "On" and [Bit for DMRS Mapping Table](#) > "On" enables mapping the DMRS sequence on each second subcarrier.

Remote command:

```
[ :SOURCE<hw> ] :BB:EUTRa:UL[ :CELL<ccidx> ] [ :SUBF<st0> ] :ALLoc<ch0> :
PUSCh:MAPPING on page 714
```

4.9.3 Channel coding / multiplexing

Access:

1. Select "General > Link Direction > Uplink (SC-FDMA)".

2. Select "Frame Configuration > General > Select User Equipment > UE1... UE4"
3. Select "PUSCH > Channel Coding and Multiplexing > State > On" (refer to [Channel Coding](#))
4. Select "Mode > UCI+UL-SCH" or "Mode > UCI only" (refer to [Mode](#))
5. Select "Frame Configuration > Subframe > Content > PUSCH"
6. Select "Enhanced Settings > Configure > HARQ ACK"

In this dialog, you can adjust the parameters for channel coding of the control information (HARQ and CQI) and configure the multiplexing of this control information with the data transmission over the UL-SCH.

HARQ ACK Settings.....	316
L ACK/NACK Mode.....	317
L N_bundled.....	317
L Number of A/N Bits.....	317
L ACK/NACK Pattern.....	317
L Number of Coded A/N Bits (CW).....	317
Rank Indication (RI) Settings.....	318
L Number of RI Bits.....	318
L RI Pattern.....	318
L Number of Coded RI Bits (CW).....	318
Channel Quality Indication (CQI) Settings.....	319
L Number of CQI Bits.....	319
L CQI Pattern.....	319
L Number of Coded CQI Bits.....	319
L CQI mapped to.....	319
UL-SCH Settings.....	319
L Phys. Bits / Total Number of Physical Bits.....	320
L Number of Coded UL-SCH Bits.....	320
L Transport Block Size/Payload (PUSCH).....	320
L Redundancy Version Index (PUSCH).....	321

HARQ ACK Settings

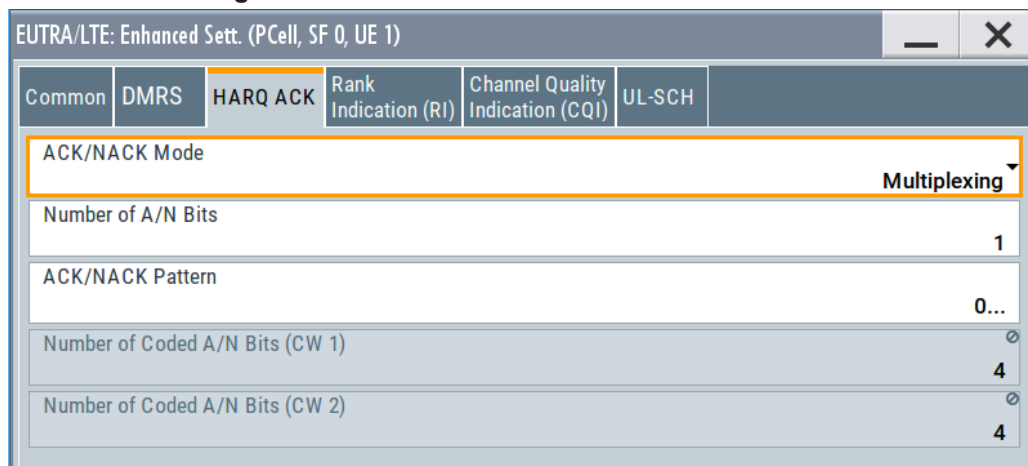

The following HARQ ACK settings are available:

ACK/NACK Mode ← HARQ ACK Settings

Sets the ACK/NACK mode to Multiplexing or Bundling according to TS 36.212, chapter 5.2.2.6.

ACK/NACK mode Bundling is defined for TDD duplexing mode only.

Remote command:

```
[ :SOURCE<hw> ] :BB:EUTRa:UL [ :CELL<ccidx> ] [ :SUBF<st0> ] :ALLoc<ch0> :
PUSCh:HARQ:MODE on page 716
```

N_bundled ← HARQ ACK Settings

For "ACK/NACK Mode Bundling", sets the parameter N_bundled according to TS 36.212, section 5.2.2.6.

Remote command:

```
[ :SOURCE<hw> ] :BB:EUTRa:UL [ :CELL<ccidx> ] [ :SUBF<st0> ] :ALLoc<ch0> :
PUSCh:HARQ:NBUNdled on page 716
```

Number of A/N Bits ← HARQ ACK Settings

Sets the number of ACK/NACK bits.

Set this parameter to 0 to deactivate the ACK/NACK transmission for the corresponding subframe.

Remote command:

```
[ :SOURCE<hw> ] :BB:EUTRa:UL [ :CELL<ccidx> ] [ :SUBF<st0> ] :ALLoc<ch0> :
PUSCh:HARQ:BITS on page 716
```

ACK/NACK Pattern ← HARQ ACK Settings

Sets the ACK/NACK bits in form of a 64 bits long pattern.

A "1" indicates an ACK, a "0" - a NACK.

The pattern is read out cyclically and if the pattern is longer than the selected "Number of ACK/NACK Bits", different bits are transmitted in different subframes using this configuration.

Remote command:

```
[ :SOURCE<hw> ] :BB:EUTRa:UL [ :CELL<ccidx> ] [ :SUBF<st0> ] :ALLoc<ch0> :
PUSCh:HARQ:PATtern on page 717
```

Number of Coded A/N Bits (CW) ← HARQ ACK Settings

Displays the number of coded ACK/NACK bits per codeword.

Remote command:

```
[ :SOURCE<hw> ] :BB:EUTRa:UL [ :CELL<ccidx> ] [ :SUBF<st0> ] :ALLoc<ch0> [ :
CW<cwid> ] :PUSCh:HARQ:CBITs? on page 717
```

Rank Indication (RI) Settings

EUTRA/LTE: Enhanced Sett. (PCell, SF 0, UE 1)					
Common	DMRS	HARQ ACK	Rank Indication (RI)	Channel Quality Indication (CQI)	UL-SCH
Number of RI Bits					1
RI Pattern					0...
Number of Coded RI Bits (CW 1)					2
Number of Coded RI Bits (CW 2)					2

Following RI settings are available:

Number of RI Bits ← Rank Indication (RI) Settings

Sets the number of rank indication (RI) bits.

Set this parameter to 0 to deactivate the RI for the corresponding subframe.

Remote command:

```
[ :SOURce<hw> ] :BB:EUTRa:UL [ :CELL<ccidx> ] [ :SUBF<st0> ] :ALLoc<ch0> :
PUSCh:RI:BITS on page 719
```

RI Pattern ← Rank Indication (RI) Settings

Sets the RI bits in form of a 64 bits long pattern.

The pattern is read out cyclically and if the pattern is longer than the selected "Number of RI Bits", different bits are transmitted in different subframes using this configuration.

Remote command:

```
[ :SOURce<hw> ] :BB:EUTRa:UL [ :CELL<ccidx> ] [ :SUBF<st0> ] :ALLoc<ch0> :
PUSCh:RI:PATtern on page 720
```

Number of Coded RI Bits (CW) ← Rank Indication (RI) Settings

Displays the number of coded RI bits per codeword.

If a "Channel Coding Mode UCI + UL-SCH" is selected, the [Number of Physical Bits for UL-SCH](#) is determinate by the number of coded bits used for CQI and RI transmission.

Remote command:

```
[ :SOURce<hw> ] :BB:EUTRa:UL [ :CELL<ccidx> ] [ :SUBF<st0> ] :ALLoc<ch0> [ :
CW<cwid> ] :PUSCh:RI:CBITs? on page 719
```

Channel Quality Indication (CQI) Settings

Common	DMRS	HARQ ACK	Rank Indication (RI)	Channel Quality Indication (CQI)	UL-SCH
Number of CQI Bits					0
CQI Pattern					0...
Number of Coded CQI Bits					0
CQI mapped to					Codeword 1

Following CQI settings are available:

Number of CQI Bits ← Channel Quality Indication (CQI) Settings

Sets the number of CQI bits before channel coding.

If a "Channel Coding Mode UCI + UL-SCH" is selected, the [Number of Physical Bits for UL-SCH](#) is determinate by the number of coded bits used for CQI and RI transmission.

Remote command:

```
[ :SOURCE<hw> ] :BB:EUTRa:UL [ :CELL<ccidx> ] [ :SUBF<st0> ] :ALLoc<ch0> :
PUSCh:CQI:BITS on page 718
```

CQI Pattern ← Channel Quality Indication (CQI) Settings

Sets the CQI pattern for the PUSCH.

The pattern is read out cyclically and if the pattern is longer than the selected "Number of CQI Bits", different bits are transmitted in different subframes using this configuration.

Remote command:

```
[ :SOURCE<hw> ] :BB:EUTRa:UL [ :CELL<ccidx> ] [ :SUBF<st0> ] :ALLoc<ch0> :
PUSCh:CQI:PATtern on page 718
```

Number of Coded CQI Bits ← Channel Quality Indication (CQI) Settings

Displays the number of coded CQI bits.

Remote command:

```
[ :SOURCE<hw> ] :BB:EUTRa:UL [ :CELL<ccidx> ] [ :SUBF<st0> ] :ALLoc<ch0> :
PUSCh:CQI:CBITs? on page 717
```

CQI mapped to ← Channel Quality Indication (CQI) Settings

Indicates the codeword the CQI is mapped to.

Remote command:

```
[ :SOURCE<hw> ] :BB:EUTRa:UL [ :CELL<ccidx> ] [ :SUBF<st0> ] :ALLoc<ch0> :
PUSCh:CQI:CODWord? on page 719
```

UL-SCH Settings

Displays the UL-SCH parameters per codeword.

EUTRA/LTE: Enhanced Sett. (PCell, SF 0, UE 1)					
Common	DMRS	HARQ ACK	Rank Indication (RI)	Channel Quality Indication (CQI)	UL-SCH
UL-SCH Codeword 1					
Total Number Of Physical Bits					1 728
Number Of Coded UL-SCH Bits					1 726
Transport Block Size/Payload					600
Redundancy Version Index					0
UL-SCH Codeword 2					
Total Number Of Physical Bits					1 728
Number Of Coded UL-SCH Bits					1 726
Transport Block Size/Payload					600
Redundancy Version Index					0

Phys. Bits / Total Number of Physical Bits ← UL-SCH Settings

Displays the size of the selected allocation in bits. The value is set automatically according to the current allocation's settings.

Remote command:

```
[ :SOURCE<hw> ] :BB:EUTRa:UL [ :SUBF<st0> ] :ALLoc<ch0> [ :CW<cwid> ] :PHYSbits? on page 705
```

```
[ :SOURCE<hw> ] :BB:EUTRa:UL [ :SUBF<st0> ] :ALLoc<ch0> :PUCCh:PHYSbits? on page 705
```

```
[ :SOURCE<hw> ] :BB:EUTRa:UL [ :CELL<ccidx> ] [ :SUBF<st0> ] :ALLoc<ch0> [ :CW<cwid> ] :PUSCh:PHYSbits? on page 705
```

Number of Coded UL-SCH Bits ← UL-SCH Settings

Displays the number of physical bits used for UL-SCH transmission.

If a "Channel Coding Mode UCI + UL-SCH" is selected, the value is calculated as follows:

"Number of Coded UL-SCH Bits" = Total Number of Physical Bits - Number of Coded CQI Bits - Number of Coded RI Bits (CW)

Remote command:

```
[ :SOURCE<hw> ] :BB:EUTRa:UL [ :CELL<ccidx> ] [ :SUBF<st0> ] :ALLoc<ch0> [ :CW<cwid> ] :PUSCh:ULSch:BITS? on page 720
```

Transport Block Size/Payload (PUSCH) ← UL-SCH Settings

Sets the size of the transport block per codeword.

In "Channel Coding Mode = UCI + UL-SCH", if "UL-SCH Codeword 1 > Transport Block Size = 0", "UL-SCH Codeword 2 > Transport Block Size" is set to 0, too.

Remote command:

```
[ :SOURce<hw> ] :BB:EUTRa:UL [ :CELL<ccid> ] [ :SUBF<st0> ] :ALLoc<ch0> [ :  
CW<cwid> ] :PUSCh:CCODing:TBSiZe on page 721
```

Redundancy Version Index (PUSCH) ← UL-SCH Settings

Sets the redundancy version index.

Remote command:

```
[ :SOURce<hw> ] :BB:EUTRa:UL [ :CELL<ccid> ] [ :SUBF<st0> ] :ALLoc<ch0> [ :  
CW<cwid> ] :PUSCh:CCODing:RVINdex on page 721
```

4.10 Enhanced PUCCH settings

Access:

1. Select "General > Link Direction > Uplink (SC-FDMA)".
2. Select "Frame Configuration > Subframe > Content > PUCCH".
3. Select "Enhanced Settings > Configure".

This dialog displays the PUCCH relevant settings and allows you to define and configure the PUCCH resource index:

- [Chapter 4.10.1, "Common settings"](#), on page 321
- [Chapter 4.10.2, "Channel coding / multiplexing"](#), on page 323

4.10.1 Common settings

Access:

1. Select "General > Link Direction > Uplink (SC-FDMA)".
2. Select "Frame Configuration > Subframe > Content > PUCCH"

3. Select "Enhanced Settings > Configure > Common".

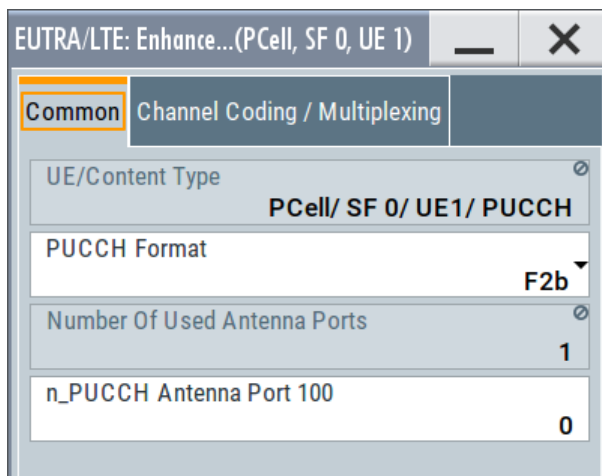

This dialog displays the PUCCH relevant settings and allows you to define and configure the PUCCH resource index.

Provided are the following settings:

UE/Content Type.....	322
PUCCH Format.....	322
Number of Used Antenna Ports.....	322
n_PUCCH.....	322

UE/Content Type

Displays the UE number and the content type of the selected allocation.

Remote command:

```
[ :SOURCE<hw> ] :BB:EUTRa:UL [ :SUBF<st0> ] :ALLoc<ch0>:CONType
on page 703
```

PUCCH Format

Sets the PUCCH Format.

Remote command:

```
[ :SOURCE<hw> ] :BB:EUTRa:UL [ :SUBF<st0> ] :ALLoc<ch0> [ :PUCCh ] :FORMat
on page 703
```

Number of Used Antenna Ports

Option: R&S SMM-K85

Displays the number of antenna ports used for transmissions of the current PUCCH format, see [Number of Antenna Ports for PUCCH per PUCCH Format](#).

Remote command:

```
[ :SOURCE<hw> ] :BB:EUTRa:UL [ :SUBF<st0> ] :ALLoc<ch0>:PUCCh:NAPused?
on page 722
```

n_PUCCH

Sets the PUCCH resource index.

3GPP Release	Parameter name	Description
Release 8/9	"n_PUCCH"	Sets the PUCCH resource index
LTE-Advanced	"n_PUCCH Antenna Port 100/200"	Sets the resource index for the first or the only one PUCCH antenna port
LTE-Advanced	"n_PUCCH Antenna Port 201"	Sets the resource index for the second PUCCH antenna port

For configuration of multi-user PUCCH tests according to [TS 36.141](#), annex A9, set the n_PUCCH parameter to the value defined in table A.9-1, column "RS orthogonal cover / ACK/NACK orthogonal cover". The R&S SMM100A calculates and configures automatically the values defined in the columns "Cyclic shift index" and "Orthogonal cover index".

Remote command:

```
[ :SOURce<hw> ] :BB:EUTRa:UL [ :SUBF<st0> ] :ALLoc<ch0>:PUCCh:NPAR<ap>
on page 722
```

4.10.2 Channel coding / multiplexing

Access:

1. Select "General > Link Direction > Uplink (SC-FDMA)".
2. Select "Frame Configuration > Subframe > Content > PUCCH"
3. Select "Enhanced Settings > Configure > Channel Coding/Multiplexing"

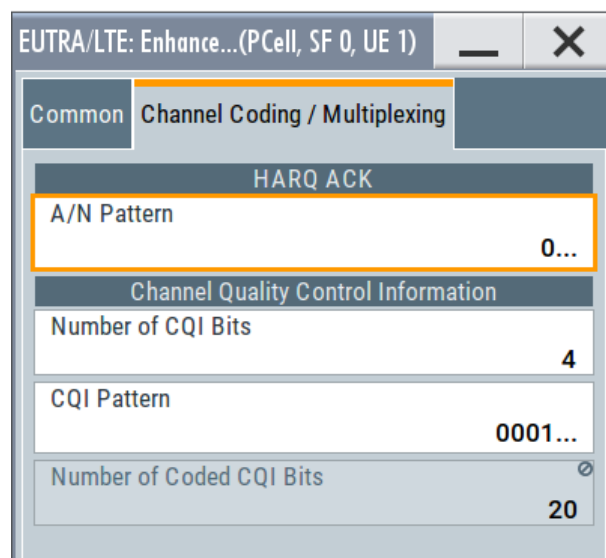

This dialog and the parameters available for configuration depend on the selected [PUCCH Format](#) for the corresponding allocation. PUCCH Format 1 carries no control information, i.e. the entire "Channel Coding/Multiplexing" section is not displayed.

CQI control information is carried by PUCCH formats 2/2a/2b and the CQI parameters are enabled if one of these formats is selected.

Provided are the following settings:

A/N Pattern / A/N+SR+CSI Pattern.....	324
Number of CQI Bits.....	325
PUCCH Format ≥ 3 Settings.....	325
L Number of A/N+SR+CSI Bits.....	326
L A/N+SR+CSI Pattern.....	326
L Number of Coded A/N+SR+CSI Bits.....	326
L M_RB.....	326
L n_oc.....	326
Number of Coded CQI Bits.....	326
CQI Pattern.....	326

A/N Pattern / A/N+SR+CSI Pattern

("A/N Pattern" required for PUCCH formats 1a/1b, 2a/2b; "A/N+SR+CSI Pattern" - all other PUCCH formats)

Use this parameter to set the ACK/NACK pattern for the PUCCH for the selected subframe. A "1" indicates an ACK, a "0" - a NACK

In PUCCH format 3, the bits given by the "ACK/NACK+SR Pattern" represent the $o^{\text{-ACK}}$ bits according to TS 36.212; these are the up to 22 bits that contain ACK/NACK information for up to two codewords and optionally SR and CSI. The number of bits used per subframe is defined by the value of the parameter "Number of A/N+SR+CSI Bits" on page 326.

To enable the generation of signals with ACK/NACK respectively ACK/NACK+SR information that varies not only per subframe but also differs over the frames, set a pattern with:

- More than 1 bit for the PUCCH formats 1a/2a
- More than 2 bits for the PUCCH formats 1b/2b
- More than "Number of A/N+SR+CSI Bits" on page 326 for PUCCH format 3

The ACK/NACK pattern has a maximal length of 32 bits and is read out cyclically.

Example:

"Duplexing Mode > FDD"

"Sequence Length = 4 Frames"

"Number of Configurable Subframes = 8"

"PUCCH Format = 1a or 2a"

"A/N Pattern = 01001"

The generated signal carries ACK/NACK information as shown on [Figure 4-16](#).

Example: PUCCH Format 1a/2a, ACK/NACK Pattern '01001'

Subframe	#0	#1	#2	#3	#4	#5	#6	#7	#8	#9
Frame#1	ACK/ NACK=0								ACK/ NACK=1	
Frame#2							ACK/ NACK=0			
Frame#3					ACK/ NACK=0					
Frame#4			ACK/ NACK=1							

Figure 4-16: ACK/NACK information per subframe for PUCCH format 1b

By changing only the PUCCH Format to 1b or 2b, the ACK/NACK information per subframe changes, see [Figure 4-17](#).

Example: PUCCH Format 1b/2b, ACK/NACK Pattern '01001'

Subframe	#0	#1	#2	#3	#4	#5	#6	#7	#8	#9
Frame#1	ACK/ NACK=01								ACK/ NACK=00	
Frame#2							ACK/ NACK=10			
Frame#3					ACK/ NACK=10					
Frame#4			ACK/ NACK=01							

Figure 4-17: ACK/NACK information per subframe for PUCCH format 2b

Remote command:

[:SOURCE<hw>] :BB:EUTRa:UL [:SUBF<st0>] :ALLoc<ch0>:PUCCh:HARQ:
PATtern on page 723

Number of CQI Bits

(PUCCH formats 2/2a/2b)

Sets the number of CQI bits before channel coding.

Remote command:

[:SOURCE<hw>] :BB:EUTRa:UL [:SUBF<st0>] :ALLoc<ch0>:PUCCh:CQI:BITS
on page 724

PUCCH Format ≥ 3 Settings

The PUCCH format 3 is required for sending of the ACK/NACK messages in case DL carrier aggregation with more than two component carriers is used.

PUCCH formats 4/5 require R&S SMM-K119

See also:

- [Chapter 2.2.5, "LTE Release 10 \(LTE-Advanced\) introduction"](#), on page 44
- [Chapter 4.2.2, "DL carrier aggregation configuration"](#), on page 70.

Number of A/N+SR+CSI Bits ← PUCCH Format ≥ 3 Settings

Sets the number of ACK/NACK+SR+CSI bits before channel coding.

Remote command:

`[:SOURCE<hw>] :BB:EUTRa:UL [:SUBF<st0>] :ALLoc<ch0>:PUCCh:HARQ:BITS`
on page 723

A/N+SR+CSI Pattern ← PUCCH Format ≥ 3 Settings

See "[A/N Pattern / A/N+SR+CSI Pattern](#)" on page 324.

Number of Coded A/N+SR+CSI Bits ← PUCCH Format ≥ 3 Settings

Displays the number of coded ACK/NACK+SR bits.

Remote command:

`[:SOURCE<hw>] :BB:EUTRa:UL [:SUBF<st0>] :ALLoc<ch0>:PUCCh:HARQ:`
`CBITS?` on page 723

M_RB ← PUCCH Format ≥ 3 Settings

Option: R&S SMM-K119

Sets the PUCCH format 4 parameter M_RB, that defines the number of contiguous resource blocks used for the PUCCH transmission. All other PUCCH formats use one resource block.

Remote command:

`[:SOURCE<hw>] :BB:EUTRa:UL [:SUBF<st0>] :ALLoc<ch0>:PUCCh:MRB`
on page 725

n_oc ← PUCCH Format ≥ 3 Settings

Option: R&S SMM-K119

For PUCCH format 5, sets the sequence index n_{oc} used for the generation of the demodulation reference signal (DMRS).

Remote command:

`[:SOURCE<hw>] :BB:EUTRa:UL [:SUBF<st0>] :ALLoc<ch0>:PUCCh:NOC`
on page 725

Number of Coded CQI Bits

Displays the number of coded CQI bits.

The number of coded CQI bits for PUCCH is always 20.

Remote command:

`[:SOURCE<hw>] :BB:EUTRa:UL [:SUBF<st0>] :ALLoc<ch0>:PUCCh:CQI:`
`CBITS?` on page 724

CQI Pattern

Sets the CQI pattern for the PUCCH.

The length of the pattern is determinate by the value of the parameter [Number of CQI Bits](#).

Remote command:

[:SOURce<hw>] :BB:EUTRa:UL[:SUBF<st0>] :ALLoc<ch0>:PUCCh:CQI: PATtern on page 724

4.10.3 Demodulation reference signal (DMRS)

Option: R&S SMM-K119

Access:

1. Select "General > Link Direction > Uplink (SC-FDMA)".
2. Select "Frame Configuration > Subframe > Content > PUCCH".
3. Select "Enhanced Settings > Configure".
4. Select PUCCH Format > Format 4/Format 5
5. Select "DMRS".

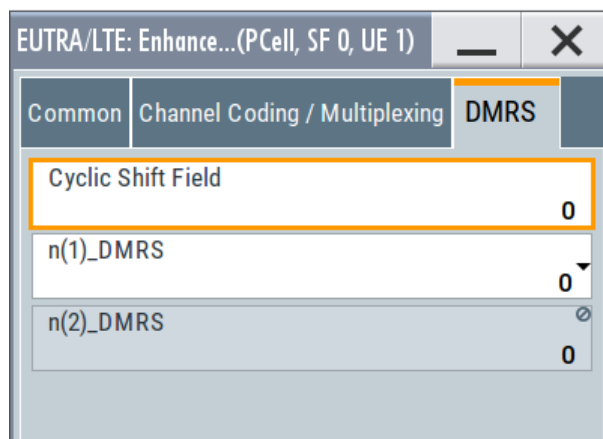

Cyclic Shift Field

Cyclic shifts are used to separate the DMRS signals of different users in the time domain. This parameter sets the cyclic shift field in the uplink-related DCI formats.

The cyclic shifts and the index $n^{(1)}_{\text{DMRS}}$ are interdependent, see [Table 4-23](#).

Table 4-23: DMRS index $n^{(1)}_{\text{DMRS}}$ as function of the cyclic shifts

Cyclic Shift Field in DCI Formats	$n^{(1)}_{\text{DMRS}}$
0	0
1	2
2	3
3	4
4	6
5	8

Cyclic Shift Field in DCI Formats	n(1)_DMRS
6	9
7	10

Remote command:

`[:SOURCE<hw>] :BB:EUTRa:UL [:SUBF<st0>] :ALLoc<ch0>:PUCCh:CYCShift`
on page 725

n(1)_DMRS

Sets the part of the demodulation reference signal (DMRS) index $n^{(1)}_{\text{DMRS}}$.

Remote command:

`[:SOURCE<hw>] :BB:EUTRa:UL [:SUBF<st0>] :ALLoc<ch0>:PUCCh:DMR1`
on page 726

n(2)_DMRS

Displays the part of the demodulation reference signal (DMRS) index $n^{(2)}_{\text{DMRS}}$, set according to [Table 4-24](#).

Table 4-24: DMRS index n(2)_DMRS as function of the PUCCH format

PUCCH format	n_oc	n(2)_DMRS
Format 4	-	0
Format 5	0	0
	1	6

Remote command:

`[:SOURCE<hw>] :BB:EUTRa:UL [:SUBF<st0>] :ALLoc<ch0>:PUCCh:DMR2?`
on page 726

5 Generating eMTC/NB-LoT signals



eMTC/NB-LoT configuration requires R&S SMM-K115.

The introduction of mobile communications extended the variety and the requirements on the way machines communicate with each other. The machine communication is known as machine type communication (MTC), the machine to machine communication (M2M) or the Internet of things (IoT).

Related 3GPP specifications

Because LTE was primarily optimized for the mobile broadband market, the specifications had to be extended to cover possible MTC solution. The following specifications specify IoT related features:

- **3GPP LTE Rel. 12 (MTC)**
First MTC specification, based on the existing LTE standard. Introduces new type CAT0 devices
- **3GPP LTE Rel. 13 (eMTC or LTE-M)**
Further development of MTC to eMTC (enhanced MTC). Introduces new type CAT-M1 devices.
- **3GPP LTE Rel. 13 (NB-LoT)**
First dedicated IoT specification, regarded as new radio access technology. Introduces new type CAT-NB1 devices.
- **3GPP LTE Rel. 14 (eMTC and NB-LoT)**
Introduces eMTC widebands and new types CAT-M2 and CAT-NB2 devices.
- **3GPP LTE Rel. 15 (NB-LoT)**
Introduces NB-LoT TDD mode in UL, FDD NPRACH formats, early data transmission, NB-LoT wake up signal and scheduling request in uplink for NPUSCH F2.
- **3GPP GERAN (EC-GSM)**
Extension in the GSM standard

Overview of the main characteristics

	eMTC (LTE-M)	NB-LoT
Based on	existing LTE standard	new radio access technology
UE category	CAT0 CAT-M1 CAT-M2	CAT-NB1 CAT-NB2
Channel bandwidth	1.4 MHz	180 KHz
Number of RB	6	1
Coverage extension (CE)	CE mode A and CE mode B	CE level 0, CE level 1 and CE level 2

LTE features not supported by eMTC or NB-LoT

Consider the following differences between eMTC and LTE/LTE-A.

- eMTC does not support:
 - Spatial multiplexing
 - Simultaneous PUCCH/PUSCH
 - Higher-order modulation schemes
 - CSI feedback
 - Transmission modes 3, 4, 8 and 10
 - PUCCH format 3, 4 and 5
 - ACK/NACK bundling multiplexing in TDD
- eMTC supports:
 - 2 HARQ processes
 - Contiguous resource allocations for UL and DL
- Among other, NB-LoT does not support:
 - Carrier aggregation
 - Home eNB, closed subscriber group (CSG)
 - Relaying
 - Dual connectivity
 - MBMS/eMBMS

Scope of this description

This section gives a brief description of the LTE Rel. 13 and some Rel. 14 features that are related to the eMTC and NB-LoT technology. The following section lists the subset of features that are covered by the software option R&S SMM-K115/-K143:

- [Chapter 5.1, "About eMTC"](#), on page 330
- [Chapter 5.2, "About NB-LoT"](#), on page 347

For an insight description of the NB-LoT features, refer to:

- White Paper [1MA266](#) "Narrowband Internet of Things"
- Application Note [1MA296](#) "Narrowband Internet of Things Measurements"

5.1 About eMTC

Short summary

eMTC is an extension of the LTE standard.

eMTC main characteristics are:

- Channel bandwidth splitting into narrowbands
Min channel bandwidth is a narrowband with 1.4 MHz or 6 RBs. 16 narrowbands can be allocated within the 20 MHz channel bandwidth.

- Four non-overlapping consequent narrowbands can be grouped into wideband with 5 MHz carrier bandwidth or 24 RBs
- Two coverage extension (CE) modes: CEModeA and CEModeB

Coverage extension modes

CE mode	CE level	Description	Optional/mandatory
CEModeA	0, 1	Supports small number of PUSCH or PUCCH repetitions	Mandatory in eMTC Rel. 13
CEModeB	2, 3	Enables large number of PUSCH or PUCCH repetitions	Optional in eMTC Rel. 13

Overview of the physical signals and channels

Because eMTC is an extension of the LTE standard, it reuses the LTE concept, including reference signals and channels. eMTC, however, does not support MIMO and MBFSN.

eMTC uses the following signals and channels:

- UL reference signals: SRS, DMRS
- DL physical channels: PDSCH, PBCH, PDCCH, and the new MPDCCH (MTC physical downlink control channel)
- UL physical channels: PUSCH (modulation QPSK, 16QAM, 64QAM), PUCCH, PRACH

See:

- [Chapter 5.1.5, "PUSCH"](#), on page 341
- [Chapter 5.1.6, "PUCCH"](#), on page 344
- [Chapter 5.1.7, "PRACH"](#), on page 346

Guard period for narrowband and wideband retuning

According to [TS 36.211](#), an eMTC transmission cannot switch the used narrowband/wideband immediately but it needs time to **retune** to the new frequency. This retuning time is referred as guard time and is defined as number of unused symbols depending on the channel type and the link direction. In any of the combinations, two symbols are left unused, see the illustrations in [Table 5-1](#).

Table 5-1: Symbols used as guard period for retuning

Link direction	Transition	Visualization on the "Time Plan"
UL	PUSCH-to-PUSCH	
	PUCCH-to-PUCCH	

Link direction	Transition	Visualization on the "Time Plan"
	PUCCH-to-PUSCH	
	PUSCH-to-PUCCH	

Related settings

- "Retuning Symbols" on page 232

5.1.1 Physical layer

Narrowbands

In eMTC, a narrowband is defined as a set of six non-overlapping consecutive physical resource blocks in the frequency domain. The number of narrowbands N_{NB} is calculated as follows:

$N_{NB} = N_{RB} / 6$, where N_{RB} is the number of the available resource blocks.

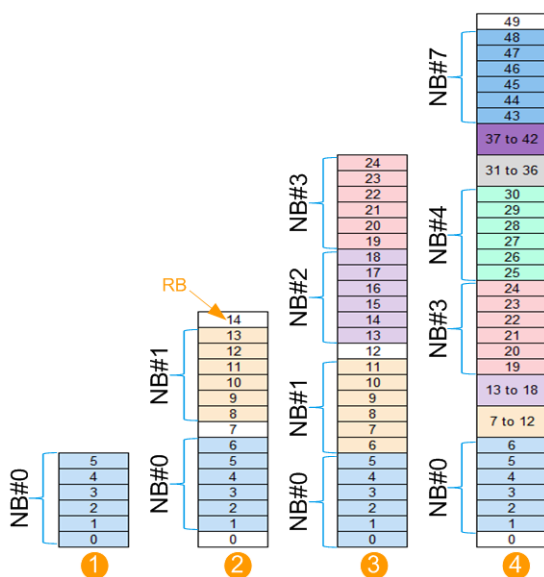

Figure 5-1: eMTC narrowbands

- NB# = Narrowband number
- RB = Resource block number
- 1 = "Channel Bandwidth = 1.4 MHz", $N_{RB} = 6$, $N_{NB} = 1$
- 2 = "Channel Bandwidth = 3 MHz", $N_{RB} = 15$, $N_{NB} = 2$
- 3 = "Channel Bandwidth = 5 MHz", $N_{RB} = 25$, $N_{NB} = 4$
- 4 = "Channel Bandwidth = 10 MHz", $N_{RB} = 50$, $N_{NB} = 8$
- White RB = Not allocated RBs

eMTC transmission is always subframe-wise. That is, the smallest resource that can be allocated is 1 RB and one subframe.

Related settings

- [Chapter 5.3.7.1, "eMTC DL valid subframes and frequency hopping"](#), on page 428
- ["Number of eMTC Narrowbands"](#) on page 227
- ["Valid Subframes"](#) on page 232

Widebands

Four non-overlapping consequent narrowbands can be grouped into wideband with 5 MHz carrier bandwidth or 24 RBs. If the number of narrowband $N_{NB} \geq 4$, the number of widebands N_{WB} is calculated as follows:

$N_{WB} = N_{NB} / 4$, where N_{RB} is the number of the available resource blocks.

If the number of narrowband $N_{NB} < 4$, all available resource blocks are allocated to the same wideband.

Related settings

- ["Wideband Config"](#) on page 228
- ["Number of eMTC Widebands"](#) on page 228

5.1.2 PBCH

eMTC reuses the PBCH structure of LTE and is hence backward compatible. The PBCH in eMTC supports merely additional repetitions for enhanced frequency tracking. A further difference is the PBCH content (i.e. MIB), that is extended with a information regarding the scheduling of the SIB1-BR paging message.

If enabled, PBCH is repeated in subframe#0 and one additional subframe in all subframes in every 40ms cycle. The additional subframe is subframe#9 for FDD or subframe#5 for TDD.

PBCH repetition is not supported if the occupied bandwidth is 1.4 MHz.

Related settings

- [Chapter 5.3.7.5, "PBCH channel coding and SIB-BR configuration"](#), on page 449

5.1.3 PDSCH

A block of N_{acc} subframes is scrambled with the PDSCH scrambling sequence. The scrambling sequence is function of the N_{CellID} and the $N_{PDSCH,abs}$.

Where:

- $N_{PDSCH,abs}$ is the number of consecutive subframes that the PDSCH transmission spans, including the invalid subframes.

- Invalid are subframes in that the PDSCH transmission is postponed.

According to TS 36.211, N_{acc} depends on the CE mode and the frame type as listed in Table 5-2.

Table 5-2: N_{acc} depending on the CE level and frame type

CE mode	CE level	Frame type 1	Frame type 2
CEModeA	0, 1	1	1
CEModeB	2, 3	4	10

For example on the $N_{PDSCH,abs}$ calculation, see [Example "Calculation of \$N_{PUSCH,abs}\$ "](#) on page 342. $N_{PDSCH,abs}$ is calculated similar to $N_{PUSCH,abs}$.

PDSCH start subframe

The PDSCH transmission starts two valid subframes after the end of the last repetition of the scheduling MPDCCH, see [Figure 5-4](#).

Repetition of PDSCH not carrying SIB1-BR

The PDSCH repetition is defined as combination of cell-specific higher-level parameters `pdsch-maxNumRepetitionCEmodeA/pdsch-maxNumRepetitionCEmodeB` and the UE-specific parameter PDSCH repetition number. The latter is part of the DCI formats 6-1A/B or 6-2.

TS 36.211 specifies the PDSCH repetition levels for all three DCI format. [Table 5-3](#) show an example of the DCI format 6-1A case.

Table 5-3: PDSCH repetition levels, defined with DCI format 6-1A [TS 36.211]

Higher-level parameter <code>pdsch-maxNumRepetitionCEmodeA</code> (cell-specific)	PDSCH Repetition Number $n1$ to $n4$ (UE-specific)
Not configured	1, 2, 4, 8
16	1, 4, 8, 16
32	1, 4, 16, 32

For information on the PDSCH repetitions, if PDSCH carries SIB1-BR, see ["System information MIB"](#) on page 336.

PDSCH hopping

PDSCH hopping is the process where the PDSCH changes the occupied narrowband on a per subframe basis. The occupied physical resource blocks (PRB) within the narrowband are maintained, merely changed is the narrowband.

Two hopping rules are defined depending on whether the PDSCH carries or not system information SIB1-BR:

- **PDSCH not carrying SIB1-BR**
Information on the PRB within a narrowband on that the PDSCH is mapped in the first subframe is transmitted by the DCI.

The hopping pattern is defined as a function of the absolute subframe number i_0 and the cell-specific higher-layer parameters $N_{NB}^{ch,DL}$, $N_{NB,hop}^{ch,DL}$ and $f_{NB,hop}^{DL}$, where:

- $N_{NB}^{ch,DL}$ is the number of consecutive subframes during which MPDCCH or PDSCH stays at the same narrowband before hopping to another narrowband
- $N_{NB,hop}^{ch,DL}$ is the number of narrowbands over which MPDCCH or PDSCH hops
- $f_{NB,hop}^{DL}$ is the hopping offset, i.e. number of narrowbands between two consecutive MPDCCH or PDSCH hops

See [Example "PDSCH not carrying SIB1-BR hopping"](#) on page 336.

• **PDSCH carrying SIB1-BR**

PDSCH transmission is repeated periodically, every 8 radio frames. If n_f is the system frame number (SFN), a period starts at frames for that $n_f \bmod 8 = 0$.

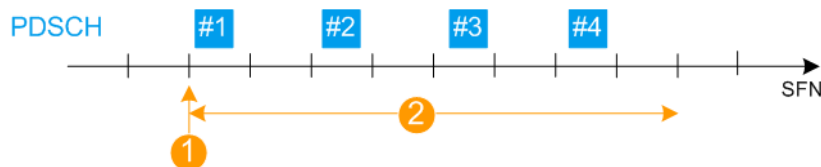

Figure 5-2: PDSCH carrying SIB1-BR transmission (Channel Bandwidth = 10 MHz)

- SFN = System frame number
- 1 = PDSCH period starts at frames for that $n_f \bmod 8 = 0$
- 2 = Period of 8 radio frames
- PDSCH #1 to #4 = 4 PDSCH repetitions, configured with the parameter "eMTC > Bitmap > Scheduling Info SIB1-BR = 1", see [Table 5-5](#).

Within each period, the PDSCH is repeated $N_{PDSCH}^{SIB1-BR}$ times, where the set of used frames and subframes n_{sf} depends on the channel bandwidth, the cell ID N_{ID}^{cell} and the frame structure type, see [Table 5-4](#).

Table 5-4: Set of frames and subframes n_{sf} for SIB1-BR [TS 36.211]

Channel bandwidth	$N_{PDSCH}^{SIB1bis}$	$N_{ID}^{cell} \bmod 2$	Frame structure 1 $n_f \bmod 2$	Frame structure 1 n_{sf}	Frame structure 2 $n_f \bmod 2$	Frame structure 2 n_{sf}
$N_{RB}^{DL} \leq 15$	4	0	0	4	1	5
	4	1	1	4	1	5
$N_{RB}^{DL} > 15$	4	0	0	4	1	5
	4	1	1	4	1	0
	8	0	0, 1	4	0, 1	5
	8	1	0, 1	9	0, 1	0
	16	0	0, 1	4, 9	0, 1	0, 5
	16	1	0, 1	0, 9	0, 1	0, 5

System information MIB

PDSCH carries the system information SIB1-BR (SystemInformationBlockType1-BR). The PDSCH allocation that carries the SIB1-BR block comprises of six contiguous localized RB within a narrowband and is repeated as defined with the parameter `schedulingInfoSIB1-BR-r13`.

See:

- [Table 5-5](#)
- [Figure 5-2](#)

Table 5-5: Number of repetitions for PDSCH carrying SIB1-BR [TS 36.213]

Value of <code>schedulingInfoSIB1-BR-r13</code>	Number of PDSCH repetitions
0	SIB1-BR is not scheduled
1, 4, 7, 10, 13, 16	4
2, 5, 8, 11, 14, 17	8
3, 6, 9, 12, 15, 18	16
19 to 31	Reserved

Example: PDSCH not carrying SIB1-BR hopping

Configure for example:

- "User 1 > 3GPP Release = eMTC CE: A"
- "Channel Bandwidth = 10 MHz" or "Number of Narrowbands = 8".
- "eMTC > Narrowband > Number of Narrowbands for Hopping $N_{NB,hop}^{ch,DL} = 4$ "
- "eMTC > Narrowband > Hopping Offset $f_{NB,hop}^{DL} = 2$ "
- "eMTC > Narrowband > Hopping Interval for CE Mode A $N_{NB}^{ch,DL} = 4$ "
- "eMTC > Bitmap > Bitmap Subframes = 10" and "SF#0 to SF#9 = On".
- "eMTC > Search Space > Max. Repetition of PDSCH for CE Mode A = 32"
- "eMTC > DCI Configuration > User 1 > DCI format 6-1A > Config > PDSCH Frequency Hopping > On", "Repetition Number = 2" and "Resource Block Assignment = 32".

Hence, the `n3` value from [Table 5-3](#) is used and "Repetitions of PDSCH = 16".

In this configuration, the first used narrowband is NB#1.

- "eMTC > Allocations > PDSCH > Num. Abs. SF $N_{PDSCH,abs} = 16$ ", i.e. one PDSCH transmission last 16 subframes
- "eMTC > Allocations > PDSCH > Start Subframe = 3"

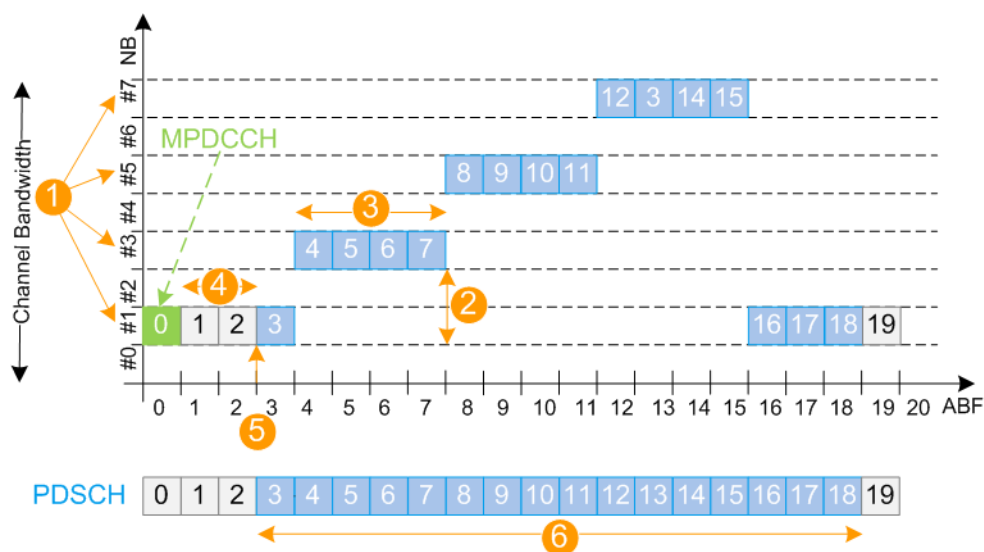

Figure 5-3: Example of PDSCH hopping

ABF = Absolute subframe number, counted from the first subframe in SFN = 0.

NB = Narrowband

#0 to #7 = Narrowband number, calculated automatically for the selected channel bandwidth

MPDCCH = One single repetition and "Start Subframe = 0"

NB#1 = "Start NB = 1", as set with the DCI field "Resource Block Assignment".

1 = $N_{NB,hop}^{ch,DL} = 4$

2 = $f_{NB,hop}^{DL} = 2$

3 = $N_{NB}^{ch,DL} = 4$

4 = PDSCH always starts 2 subframes after the last repetition of the MPDCCH the shared channel is scheduled

5 = "PDSCH Start Subframe = 3" i.e. 2 subframes after the MPDCCH transmission

6 = $N_{PDSCH,abs} = 16$

Related settings

- ["Narrowbands"](#) on page 430
- ["Max. Repetitions of PDSCH for CE Mode A/B"](#) on page 433
- ["DCI Format 6-1A/6-1B"](#) on page 438
- [Chapter 5.3.7.6, "PDSCH channel coding and scrambling"](#), on page 452
- [Chapter 5.3.7.4, "eMTC allocations \(PBCH, MPDCCH, PDSCH\)"](#), on page 445

5.1.4 MPDCCH

The eMTC physical downlink shared channel MPDCCH in eMTC is similar to the LTE EPDCCH in terms of structure and purpose. In both cases, this control channel carries scheduling assignments. It is transmitted in an MPDCCH set, mapped to group of resource elements called ECCEs (enhanced control channel elements) and it can use localized or distributed transmission scheme. EPDCCH is user-specific but MPDCCH also includes common search spaces (Type1 and Type2).

Other than in LTE, in eMTC the MPDCCH set consists of 2, 4, or 6 physical resource block (PRB) pairs. There is also the additional MPDCCH format 5, see [Table 5-6](#).

Table 5-6: MPDCCH formats and number of ECCEs for one MPDCCH N_{ECCE}^{MPDCCH} [TS 36.211]

MPDCCH format	Case A	Case B
0	2	1
1	4	2
2	8	4
3	16	8
4	32*	16*
5	24	12

*) MPDCCH format 4 is supported if distributed transmission is used.

The MPDCCH is transmitted over N_{rep}^{MPDCCH} consecutive valid downlink subframes and spans $N_{MPDCCH,abs}$ consecutive subframes, including the invalid subframes where the transmission is postponed.

MPDCCH hopping

If frequency hopping is enabled, the narrowband for the MPDCCH transmission (NB_{start}) in the first subframe is given by higher-layer; it can be different per MPDCCH set. The hopping pattern is defined as a function of the absolute subframe number i_0 and the cell-specific higher-layer parameters $N_{NB}^{ch,DL}$ (interval-DLHoppingConfigCommon), $N_{NB,hop}^{ch,DL}$ (mpdcch-pdsch-HoppingNB-r13) and $f_{NB,hop}^{DL}$ (mpdcch-pdsch-HoppingOffset-r13), where $N_{NB,hop}^{ch,DL} = 2$ or 4 narrowbands.

See [Example"PDSCH not carrying SIB1-BR hopping"](#) on page 336.

Search spaces

eMTC UE monitors the following MPDCCH search spaces:

- Type 0 common search space, if configured with CE Mode A
- Type 1 common search space, used for paging
- Type 2 common search space, used for random access (RA)
- UE-specific search space

The search space defines the MPDCCH candidates that the UE has to monitor. The UE is expected to decode only the control information on an MPDCCH that is transmitted over ECCEs within the search space the UE monitors.

MPDCCH starting subframe

The MPDCCH starting subframe depends on the used search space and is calculated similar to the NPDCCH starting subframe, see ["Calculating the NPDCCH starting subframe"](#) on page 355.

MPDCCH repetition number

The number of times the MPDCCH is repeated $N_{\text{rep}}^{\text{MPDCCH}}$ is defined as a function of the R_{max} value and the repetition level $r1$ to $r4$, where:

- R_{max} gives the maximum number of MPDCCH repetitions and is defined per search space, see [Table 5-8](#) and [Table 5-9](#).
- Repetition level is set by the DCI field "Subframe Repetition Number" of the corresponding DCI format, see [Table 5-7](#).

Table 5-7: Repetition level $r1$ to $r4$ as function of the DCI subframe repetition number field

R	r1	r2	r3	r4
"DCI Subframe Repetition Number"	0	1	2	3

Table 5-8: MPDCCH repetition number for Search Space = UE-specific or Type 0/Type 2 Common

R_{max}	r1	r2	r3	r4
1	1			
2	1	2		
4	1	2	4	
≥ 8	$R_{\text{max}}/8$	$R_{\text{max}}/4$	$R_{\text{max}}/2$	R_{max}

Table 5-9: MPDCCH repetition number for Search Space = Type 1 Common

R_{max}	r1	r2	r3	r4
1	1			
2	1	2		
4	1	2	4	
8	1	2	4	8
16	1	4	8	16
32	1	4	16	32
64	2	8	32	64
128	2	16	64	128
256	2	16	64	256

Example: MPDCCH repetitions (UE-specific search space)

Configure for example:

- "eMTC > Bitmap > Bitmap Subframes = 10" and "SF#0 to SF#9 = On".
- "eMTC > Search Space > Max. Repetition of MPDCCH Rmax (Type 2 Common) = 4".
- "User Configuration > User 1 > 3GPP Release = eMTC CE: A".
- "User Configuration > User 1 > MPDCCH Config:": "Max. Repetition of MPDCCH Rmax (User-Specific search space) = 4", "MPDCCH Hopping > On" and "Search Space Start Subframe = 1".
- "eMTC > DCI Configuration > User 1 > DCI format 6-1A > Search Space = UE-Specific" and "DCI format 6-1A > Config > DCI Subframe Repetition Number = 2". Hence the r3 value from Table 5-8 is used and "MPDCCH Repetitions = 4".
- "eMTC > Allocations > MPDCCH > Start Subframe = 1"

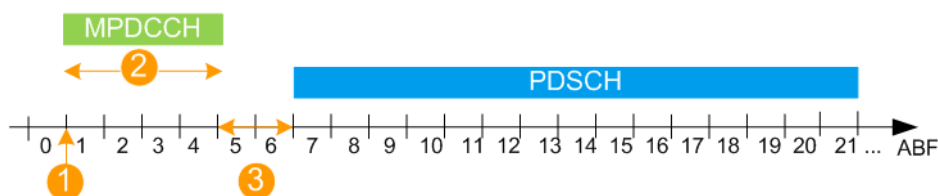

Figure 5-4: Example of MPDCCH repetitions and PDSCH cross-scheduling (UE-specific search space)

- 1 = MPDCCH start subframe
- 2 = MPDCCH Repetitions
- 3 = PDSCH always starts 2 subframes after the last repetition of the MPDCCH the shared channel is scheduled

DCI formats, decoding and content

Table 5-10 gives an overview of the defined DCI formats.

Table 5-10: DCI formats

DCI format	Purpose	CE Mode	"User x"/ P-RNTI/ RA-RNTI	Search space
3 3A	As in LTE Transmission of TPC Commands for MPUCCH and MPUSCH 2 bits and 1-bit power adjustment respectively	CE Mode A	"User x"	UE-specific Type 2 common
6-0A	Scheduling of PUSCH in one UL cell Resource allocation type 0	CE Mode A	"User x"	UE-specific Type 0 common
6-0B	Scheduling of PUSCH in one UL cell Resource allocation type 2, without TPC and CSI request	CE Mode B	"User x"	UE-specific
6-1A	Scheduling of one PUSCH codeword in one cell Random access procedure initiated by a PDSCH order Resource allocation type 2	CE Mode A	"User x" RA-RNTI	UE-specific Type 0 common Type 2 common

DCI format	Purpose	CE Mode	"User x"/ P-RNTI/ RA-RNTI	Search space
6-1B	Scheduling of one PUSCH codeword in one cell Random access procedure initiated by a PDSCH order Resource allocation with 1 bit	CE Mode B	"User x" RA-RNTI	UE-specific Type 2 common
6-2	Paging and direct indication	-	P-RNTI	Type 1 common

Table 5-11 gives the DCI formats **decoding** for MPDCCH and PDSCH.

Table 5-11: DCI decoding [TS 36.213]

MPDCCH and PDSCH configured with:	Transmission Mode	DCI format	Search space	PDSCH transmission scheme, corresponding to MPDCCH
P-RNTI	-	6-2	Type 1 common	<ul style="list-style-type: none"> If number of PBCH antenna ports = 1, Single-antenna port, port 0 Otherwise, Transmit diversity
RA-RNTI	-	6-1A 6-1B	Type 2 common	<ul style="list-style-type: none"> If number of PBCH antenna ports = 1, Single-antenna port, port 0 Otherwise, Transmit diversity
C-RNTI	Mode 1	<ul style="list-style-type: none"> 6-1A 6-1A or 6-1B 	<ul style="list-style-type: none"> Type 0 common UE-specific 	Single-antenna port, port 0
	Mode 2	<ul style="list-style-type: none"> 6-1A 6-1A or 6-1B 	<ul style="list-style-type: none"> Type 0 common UE-specific 	Transmit diversity
	Mode 6	6-1A	<ul style="list-style-type: none"> Type 0 common UE-specific 	<ul style="list-style-type: none"> Transmit diversity Closed-loop spatial multiplexing, single layer transmission
	Mode 9	<ul style="list-style-type: none"> 6-1A 6-1A or 6-1B 	<ul style="list-style-type: none"> Type 0 common UE-specific 	<ul style="list-style-type: none"> Single-antenna port, port 0 or transmit diversity Single-antenna port, port 7 or 8

Related settings

- [Chapter 5.3.7.2, "Search space settings"](#), on page 431
- [Chapter 5.3.7.3, "eMTC DCI configuration"](#), on page 433
- [Chapter 5.3.7.4, "eMTC allocations \(PBCH, MPDCCH, PDSCH\)"](#), on page 445

5.1.5 PUSCH

A block of N_{acc} subframes is scrambled with the PUSCH scrambling sequence. The scrambling sequence is function of the N_{CellID} and the $N_{\text{PUSCH,abs}}$.

Where:

- $N_{\text{PUSCH,abs}}$ is the number of consecutive subframes that the PUSCH transmission spans, including the invalid subframes.

- Invalid are subframes in that the PUSCH transmission is postponed.

According to TS 36.211, N_{acc} depends on the CE mode and the frame type as listed in Table 5-12.

Table 5-12: N_{acc} depending on the CE level and frame type

CE mode	CE level	Frame type 1	Frame type 2
CEModeA	0, 1	1	1
CEModeB	2, 3	4	5

Example: Calculation of $N_{PUSCH,abs}$

If:

- ValidSF = 0, 2, 3, 4, 5
- $n_{invalidSF} = 1$

eMTC Parameters					
Valid Subframes					
SF0 UL <input checked="" type="checkbox"/> On	SF1 UL <input type="checkbox"/> On	SF2 UL <input checked="" type="checkbox"/> On	SF3 UL <input checked="" type="checkbox"/> On	SF4 UL <input checked="" type="checkbox"/> On	SF5 UL <input checked="" type="checkbox"/> On

Figure 5-5: Valid subframes configuration ("General UL Settings > Cell > eMTC Parameters")

- StartSF = 0
- $n_{Rep}^{PUSCH} = 4$

Then $N_{PUSCH,abs} = 4 + 1 = 5$

	Content	Modulation Format	Enhanced Settings	Start Subframe	Repetitions	No. Absolute Subframes	Start Narrowband	No. RB	Offset VRB	Power /dB
1	PUSCH	QPSK	Config...	0	4	5	0	5	0	0.000

Figure 5-6: No. absolute subframes ("UL Frame Configuration > UE x > eMTC Allocation")

PUSCH frequency hopping

PUSCH can utilize frequency hopping.

- If hopping is disabled, the PUSCH repetitions are located in the same resource block at the same narrowband.
- If hopping is enabled, then PUSCH is transmitted in a given NB for a selected number of consecutive subframes ($N_{PUSCH,abs}$)

The frequency-hopping pattern is calculated depending on the following:

- Absolute subframe number (ASF) of the first UL subframe in that the PSUCH is scheduled
- The cell-specific higher-level parameter $f_{NB,hop}$ that defines the hopping offset between the current and the subsequent narrowband

- The cell-specific higher-level parameter $N_{NB,ch}$ that set the number of subframes the hopping pattern remains in the same narrowband
- Number of absolute subframes $N_{PUSCH,abs}$

Example: PUSCH hopping

Configure, for example, the following settings:

- "ARB > Sequence Length = 10 Frames"
- In the "General UL Settings" dialog:
 - "Cell > eMTC Parameters > Valid Subframes > SF x UL > On" (all UL subframes)
 - "PUSCH Narrowband Hopping > On" and "Hopping Offset = 2" ($f_{NB,hop} = 2$)

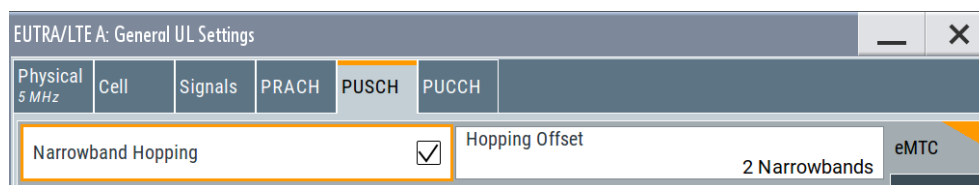

- "UL Frame Configuration > UE 1 > 3GPP Release > eMTC" and "UE 1 > State > On"
- In the "UE 1 > User Configuration > eMTC Allocation" dialog, configure one PUSCH transmission:
 - "Narrowband Hopping Interval = 4" ($N_{NB,ch} = 4$)
 - "Start Subframe = 61" ("Frame = 60", "Subframe = 1"), "Repetitions = 16", "Start Narrowband = 1"

The calculated number of absolute subframes is $N_{PUSCH,abs} = 16$

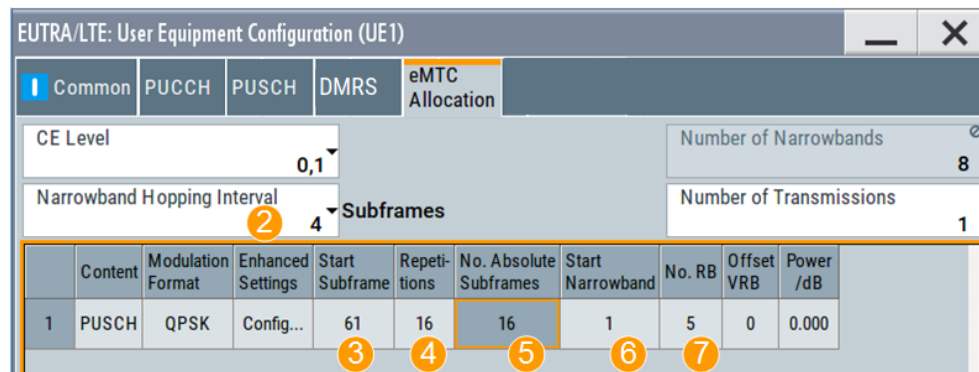

2, 3, 4, 5, 6, 7 = The effect on the settings is illustrated on [Figure 5-7](#)

- In the "Time Plan", select "1st Subframe = 60" and "Subframes = 20".

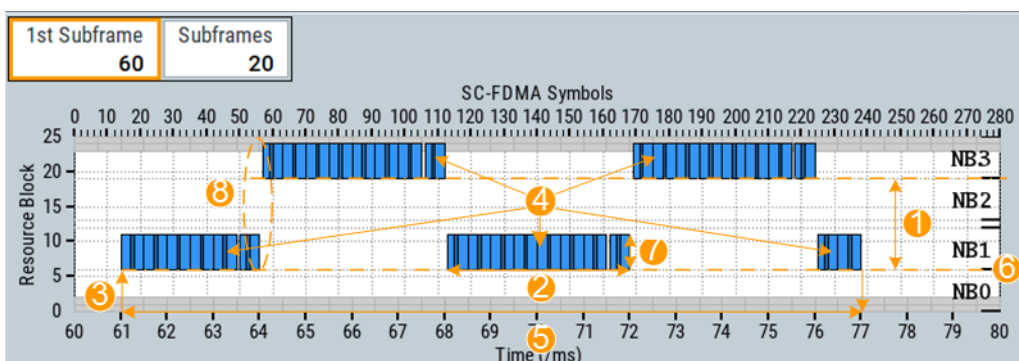

Figure 5-7: PUSCH hopping: understanding the displayed information

- 1 = $f_{NB,hop} = 2$ (the offset between the start of two subsequent narrowbands is 2)
- 2 = $N_{NB,ch} = 4$ (PUSCH remains in the same narrowband for four subframes)
- 3 = StartSF = 61 (start subframe number)
- 4 = $n_{Rep}^{PUSCH} = 16$ (PUSCH is repeated a total number of 16 times)
- 5 = $N_{PUSCH,abs} = 16$ (number of absolute subframes)
- 6 = Start narrowband = NB1
- 7 = Number of RB per narrowband
- 8 = Guard period for retuning, see Figure 5-7

- To observe the unused slots at each narrowband hop at greater detail, select "1st Subframe = 61" and "Subframes = 7".

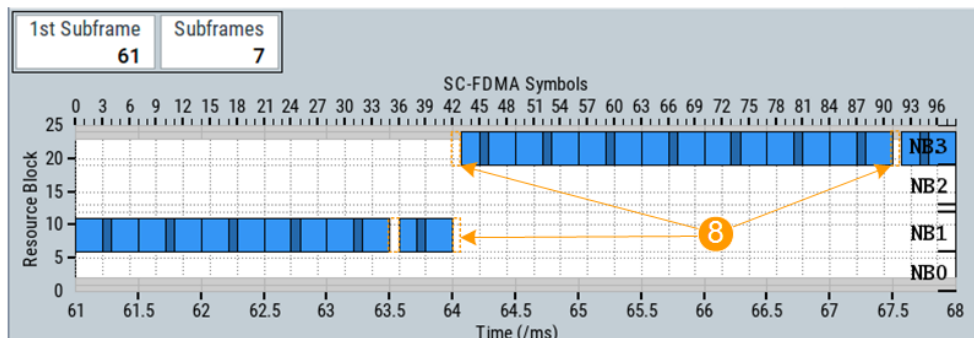

Figure 5-8: Narrowband hop with PUSCH-to-PUSCH transition

- 8 = The last and the first symbols are unused at each narrowband hop in a PUSCH-to-PUSCH transition (see also "Guard period for narrowband and wideband retuning" on page 331)

5.1.6 PUCCH

PUCCH can be transmitted once or repeated defined number of times. It is transmitted during defined number of consecutive subframes and is postponed during the invalid subframes.

PUCCH allocation in terms of resource blocks is calculated depending on the:

- Absolute subframe number (ASF) of the first UL subframe in that the PSUCH is scheduled
- The cell-specific higher-level parameter $N_{NB,ch}$ that set the number of subframes the hopping pattern remains in the same narrowband.

- Number of absolute subframes $N_{PUCCH,abs}$

For more information on the $N_{NB, ch}$, $N_{PUCCH,abs}$ and the term invalid subframes, see [Chapter 5.1.5, "PUSCH"](#), on page 341.

Example: PUCCH configuration

This example extends the configuration used in [Example "PUSCH hopping"](#) on page 343.

- In the "General UL Settings > PUCCH" dialog, select "Number of RBs used for PUCCH = 4" and "Delta Shift = 1".

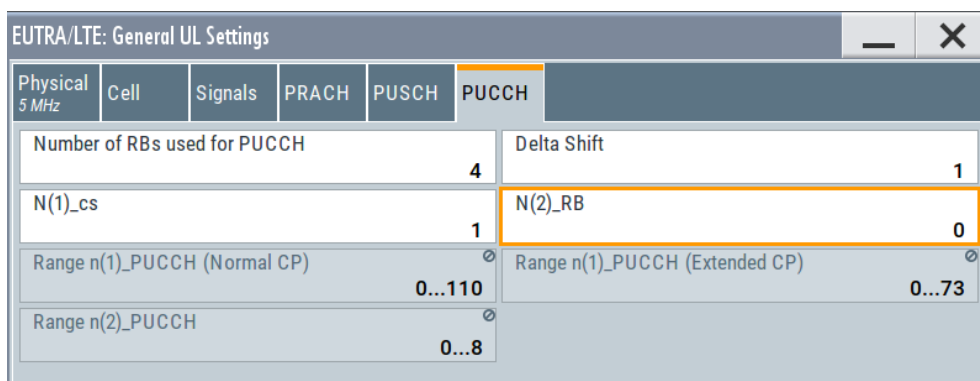

- In the "UE 1 > User Configuration > eMTC Allocation" dialog, add one PUCCH transmission with "Repetitions = 8" ($n_{Rep}^{PUCCH} = 8$)
The start subframe is set automatically.

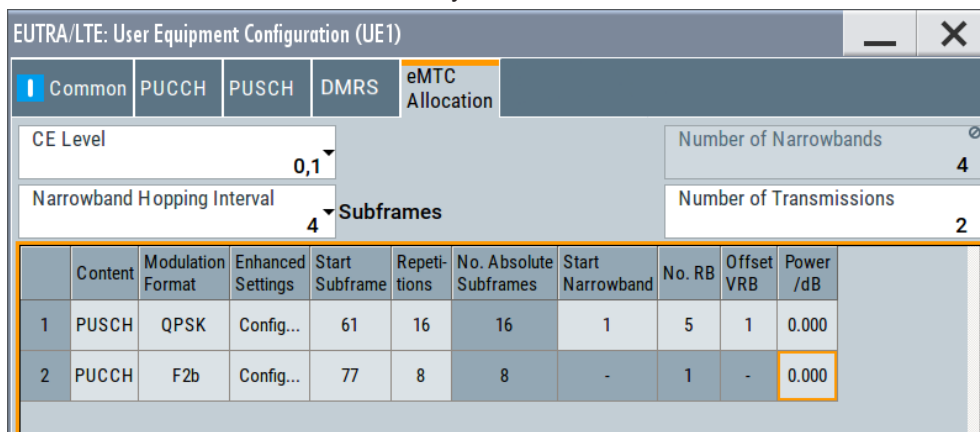

- Observe the "Time Plan".

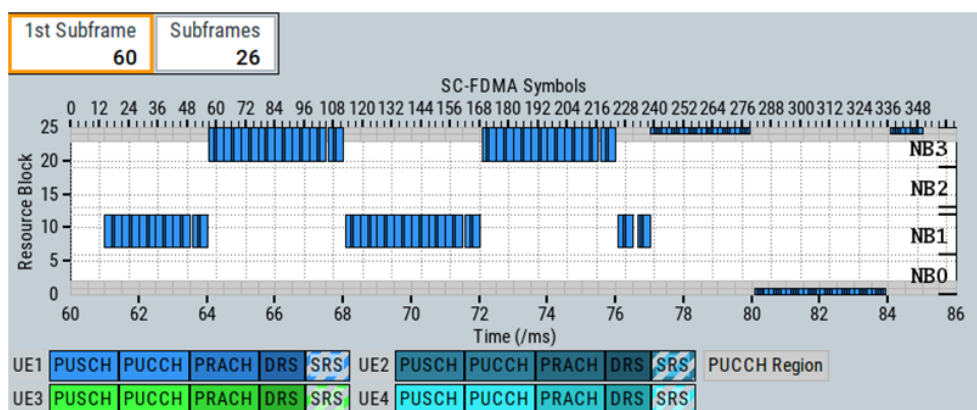

Figure 5-9: PUCCH hopping: understanding the displayed information

- 1 = "PUCCH Region = 4 RBs" (two RBs at each channel bandwidth end)
- 2 = $N_{\text{NB, ch}} = 4$ (PUCCH remains in the same RB four subframes)
- 3 = StartSF = 77 (start subframe number)
- 4 = $n_{\text{Rep}}^{\text{PUCCH}} = 8$ (PUCCH is repeated eight times)
- 5 = $N_{\text{PUCCH, abs}} = 8$ (number of absolute subframes)

5.1.7 PRACH

As in LTE, eMTC PRACH configuration comprises cell-specific and UE-specific parameters. Different than in LTE that defines one single PRACH configuration, in eMTC there are four eMTC PRACH configurations, one per CE level.

The following cell-specific parameters define the eMTC PRACH configurations:

- PRACH hopping offset $f_{\text{PRB, hop}}^{\text{PRACH}}$ (`prach-HoppingOffset`) in terms of RBs and common for all PRACH allocations
- One PRACH configuration per CE level, configured with:
 - PRACH configuration index (`prach_ConfigurationIndex`) that selects the predefined PRACH distribution pattern
 - PRACH frequency offset ($n_{\text{PRB offset}}^{\text{RA}}$) (`prach_FrequencyOffset`) in terms of RBs that shift the PRACH allocation in the frequency domain
The physical RBs used for the PRACH allocation ($n_{\text{PRB offset}}^{\text{RA}}$) depend also on the system frame number (SFN). If frequency hopping is used for frame type 2, also on the UL/DL configuration.
 - PRACH frequency hopping (`prach_HoppingConfig`)
 - Number of PRACH repetitions per attempt ($N_{\text{rep}}^{\text{PRACH}}$) (`numRepetitionPerPreambleAttempt`)
See [Table 5-13](#)
 - Optionally, PRACH starting subframe periodicity $N_{\text{start}}^{\text{PRACH}}$ (`prach_StartingSubframe`)

Table 5-13: Number of PRACH repetitions per attempt depending on the PRACH format

PRACH configuration index		PRACH format	N _{rep} ^{PRACH}
(Frame type 1)	(Frame type 2)		
0 to 15	0 to 19	0	≥ 1
16 to 31	20 to 29	1	≥ 1
32 to 47	30 to 39	2	≥ 1
48 to 63	40 to 47	3	≥ 1
-	48 to 57	4	1

A UE can start up to 40 preamble attempts, where each subsequent of them has to use a PRACH configuration that corresponds to a higher CE level. The frequency allocation of each preamble is retrieved from the cell-specific PRACH configuration of the selected CE level. UEs can merely postpone the preamble in time by defining the first subframe it appears. Preamble attempts do not overlap; any subsequent preamble attempt starts after the previous one is completed.

Each preamble occupies 6 consecutive resource blocks. Preambles are generated from Zadoff-Chu sequences.

5.2 About NB-LoT

Short summary

NB-LoT addresses the low-cost requirement of the IoT market. It does not support complex LTE features like carrier aggregation.

NB-LoT is new air interface with the following main characteristics:

- 180kHz carrier bandwidth (or 200 KHz channel bandwidth) in both uplink and downlink.
This bandwidth corresponds to one resource block in LTE transmission
- Three different operating modes, see ["Operating modes"](#) on page 348
- Three kinds of coverage extension (CE) levels: CE level 0, CE level 1 and CE level 2
Where the CE level 2 indicates the worst coverage situation
- UE that support NB-LoT are tagged with the category CAT-NB1
- NB-LoT is defined for FDD and half duplexing mode

Overview of the physical signals and channels

Defined are:

- DL narrowband primary and secondary synchronization signals (NPSS and NSSS)
See [Chapter 5.2.2, "NPSS and NSSS"](#), on page 351.
- DL narrowband reference signals (NRS)

See [Chapter 5.2.3, "NRS"](#), on page 352

- DL physical channels:
NPBSCH (narrowband physical broadcast channel), NPDSCH (narrowband physical downlink shared channel), NPDCCH (narrowband physical downlink control channel)
See:
 - [Chapter 5.2.4, "NPBCH"](#), on page 353
 - [Chapter 5.2.6, "NPDSCH"](#), on page 358
 - [Chapter 5.2.5, "NPDCCH"](#), on page 354
- UL narrowband demodulation reference signals (NDRS)
See [Chapter 5.2.7, "NDRS"](#), on page 360.
- UL physical channels:
NPUSCH (narrowband physical uplink shared channel), NPRACH (narrowband physical uplink random access channel)
See:
 - [Chapter 5.2.8, "NPUSCH"](#), on page 361
 - [Chapter 5.2.9, "NPRACH"](#), on page 364

5.2.1 Physical layer

NB-LoT reuses the LTE resource grid:

- The time domain structure of LTE is reused. There are 7 OFDM symbols within a slot, as it is in the normal CP case.
- Per OFDM DL symbol, there are 12 subcarriers spaced at 15 KHz and hence occupying 180 kHz bandwidth.
- In UL, the eNB decides which of the two allowed subcarrier spacings to apply (see [Table 5-14](#))
For the spacing of 3.75 KHz, for instance, there are 48 subcarriers available within a resource block of 180 kHz.
- One subcarrier in one OFDM symbol is referred as a resource element.

Table 5-14: Number of subcarriers in downlink N_{sc}^{DL} and uplink N_{sc}^{UL}

Subcarrier spacing	N_{sc}^{DL}	N_{sc}^{UL}	Slot duration, ms
$\Delta f = 3.75$ KHz	-	48	2
$\Delta f = 15$ KHz	12	12	0.5

In DL, NB-LoT supports transmission over up to two antenna ports (AP2000 and AP2001), where the same transmission scheme applies for all DL physical channels

Operating modes

[Figure 5-10](#) illustrates the three different NB-LoT operating modes.

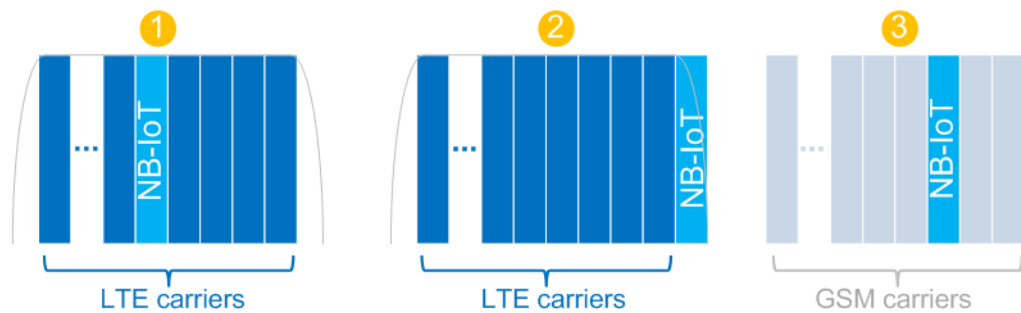

Figure 5-10: NB-LoT operating modes

1 = In-band operation by reusing free LTE resource blocks (supported in LTE bandwidths larger than 200 kHz)*

2 = Guard band operation by using the spectrum between neighboring LTE carriers (unused LTE guard band resource blocks)

3 = Standalone operation in free GSM spectrum

* = In-band operation in DL is not supported in the 1.4 MHz bandwidth

NCell ID $N^{\text{NCell_ID}}$

NB-LoT maintains the concept of up to 504 physical cell IDs (PCI). It is referred as NCell ID or $N^{\text{NCell_ID}}$.

Regarding the PCI, the specification defines two modes:

- **In-band operation with same PCI ($N^{\text{NCell_ID}} = \text{PCI}$)**

Where $N^{\text{NCell_ID}}$ is the NB-LoT cell ID and PCI is the physical cell ID of the LTE cell. In this mode, NB-LoT and LTE share the same PCI and use the same number of CRS and NRS ports:

There can be a maximum number of two CRS ports, because the number of narrowband reference signals $N_{\text{NRS}} \leq 2$.

(see [NRS](#))

- **In-band different PCI operation ($N^{\text{NCell_ID}} \neq \text{PCI}$)**

The LTE cell and the NB-LoT cell operate in the same band but have a different PCI.

The number of CRS ports could be different than the N_{NRS}

Examples

Example: Configuring an NB-LoT allocation in standalone operating mode

Standalone NB-LoT operation is the default and the only one possible mode when the channel bandwidth is set to 200 kHz.

In DL:

- Select "General DL Settings > Physical > Channel Bandwidth = 200 kHz".
- Select "NB-LoT Carrier Allocation".
The parameter "Mode = Standalone" confirms that in the selected channel bandwidth, only NB-LoT standalone operation is possible.

In UL:

- Select "General UL Settings > Physical > Channel Bandwidth = 200 kHz".
- Select "UL Frame Configuration > UEx > 3GPP Release = NB-LoT".
- Select "UEx > User Equipment Configuration > NB-LoT Allocation".
The parameter "Mode = Standalone" confirms that in the selected channel bandwidth, only NB-LoT standalone operation is possible.

Example: Enabling an NB-LoT UL in-band operation

An NB-LoT in-band or guard-band operation requires channel bandwidth wider than 200 kHz, 1.4 MHz or wider for UL (and 3MHz or wider for DL). The following example shows you how to allocate the NB-LoT transmission around the DC carrier.

1. Select a channel bandwidth wider than 200 kHz and containing even number of resource blocks.
For example "General UL Settings > Physical > Channel Bandwidth = 3 MHz".
The 3 MHz channel bandwidth consists of 15 resource blocks.
2. Select "UL Frame Configuration > UEx > 3GPP Release = NB-LoT".
3. Select "UEx > User Equipment Configuration > NB-LoT Allocation".
4. Select "Mode = In-band".
5. Select "Resource Block Index = 7".
6. Observe the "Time Plan".
Use the "View Mode > Channel BW".

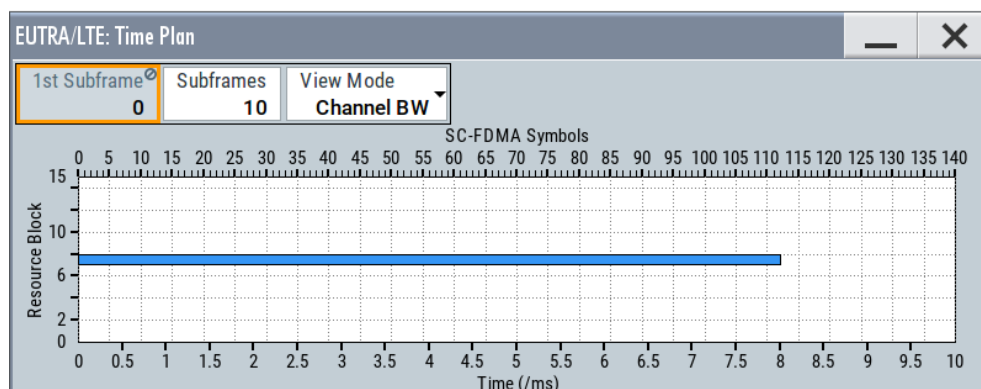

7. To shift the default NPUSCH allocation within the resource block, select "NB-LoT Allocation > NPUSCH#1 > Subcarrier Indication = 6".
8. In the "Time Plan", set the "View Mode = Single RB".

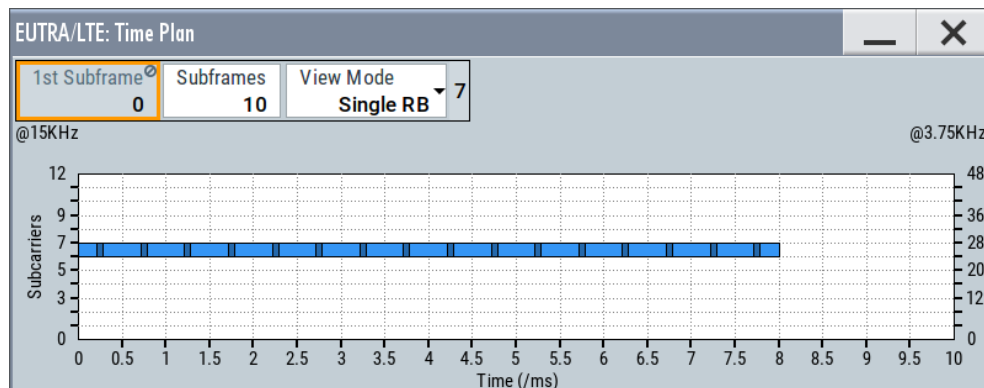

Example: Enabling mixed LTE and NB-LoT configuration

Extend the configuration in [Example "Enabling an NB-LoT UL in-band operation"](#) on page 350 with the following:

- Select "General > LTE/loT Standard > LTE/eMTC/NB-LoT".
- In the "UL Frame Configuration > General" dialog, enable second UE with "3GPP Release = LTE/LTE-A".
- In the "UL Frame Configuration > Subframe" dialog, enable at least the PUSCH allocation of the LTE UE.
- Set for example:
 - "PUCCH/PUSCH > State > On"
 - "PUSCH > Set 1 No. RB = 12" to allocate the entire channel bandwidth
- Observe the time plan in both view modes.

5.2.2 NPSS and NSSS

As in the LTE, the DL primary and secondary synchronization signals (NPSS and NSSS) are used for cell search, time and frequency synchronization, and obtaining the cell ID.

The carrier on which the UE detects the NPSS/NSSS/NPBCH/SIB-NB is referred as **anchor carrier**.

The NPSS and NSSS have the following transmission patterns:

- NPSS is transmitted in the sixth subframe (SF#5) of every frame. It spans 11 subcarriers and uses one fixed 11-bit log Zadof-Chu sequence.
- NSSS is transmitted in the tenth subframe (SF#9) in the even-numbered frames, that fulfill the following condition:
 $n_f \bmod 2 = 0$, where n_f is the frame number.

NSSS spans 12 subcarriers and is generated from a 131-bit length Zadof-Chu sequence, that is scrambled and cyclically shifted also with the NCell ID, see "NCell ID $N^{\text{Ncell_ID}}$ " on page 349.

No other signals can be scheduled during the subframes NPSS or NSSS are transmitted.

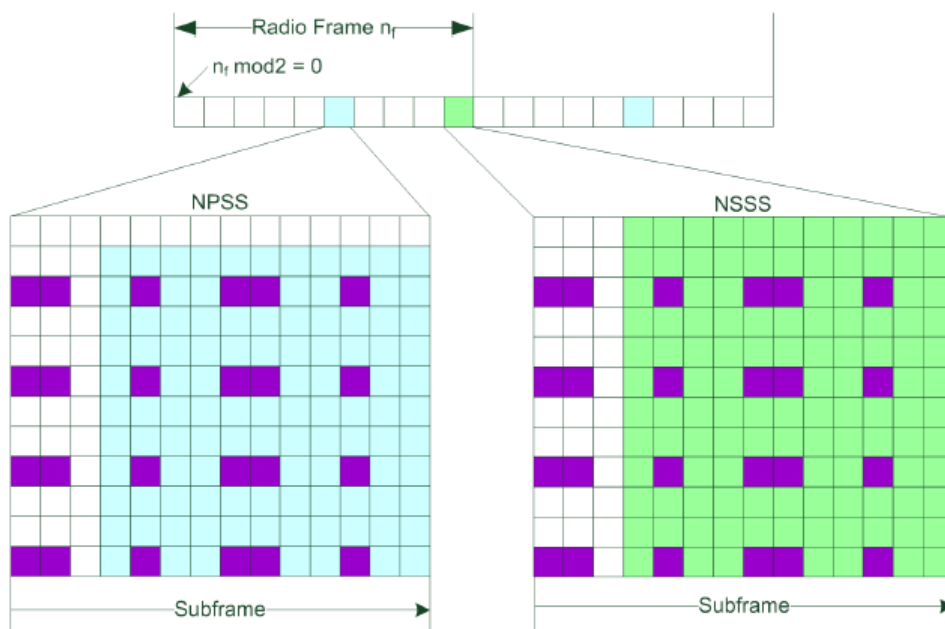

Figure 5-11: NPSS and NSSS allocation with 4 antenna port LTE CRS transmission* [1MA266]

Blue = NPSS

Green = NSSS

White = First three OFDM symbols are reserved for the LTE PDCCH and hence omitted by NB-IoT

Violet = LTE CRS; in in-band mode, all possible LTE CRS resource elements are omitted by NB-IoT

* = NRS is not transmitted in the NPSS and NSSS subframes

5.2.3 NRS

- NRS is transmitted in the last two OFDM symbols of each slot, if these slots are not used for NPSS or NSSS.
- Can be transmitted on one or two antenna ports (AP2000/AP2001), depending on the transmission scheme.
- NRS is mapped on a similar way as the RS in LTE, see Figure 5-12.
- NRS is cyclically shifted by the NCell ID

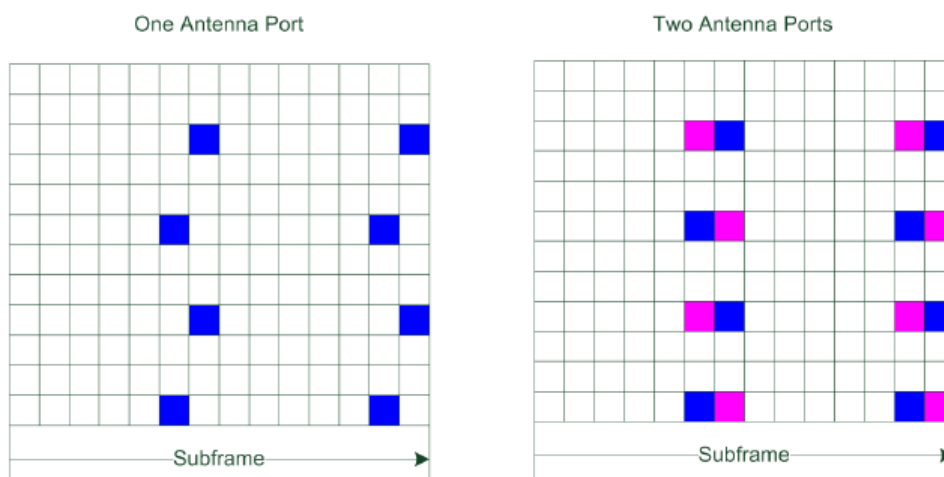

Figure 5-12: NRS mapping to the resource elements (one and two antenna ports) [1MA266]

With this structure, there is no overlap between the NRS and the LTE CRS.

The NRS position depends on the duplexing mode; in TDD mode, it depends on the special subframe configuration. Observe the timeplan for current allocation.

5.2.4 NPBCH

The narrowband physical broadcast channel (NPBCH) is QPSK modulated and carries narrowband master information block MIB-NB information.

MIB-NB

MIB-NB is scrambled with the $N^{\text{Ncell}}_{\text{ID}}$. It contains 34 bits and is transmitted over 64 frames. The MIB-NB is split into 8 blocks, where each block is transmitted on the first subframe (SF#0) in a frame and is repeated in the subsequent 7 frames.

MIB-NB carries important information and among other, it indicates the starting frame of SIB1-NB and repetitions, see "SIB1-NB" on page 359.

Figure 5-13 shows the subframe structure of the NPBCH.

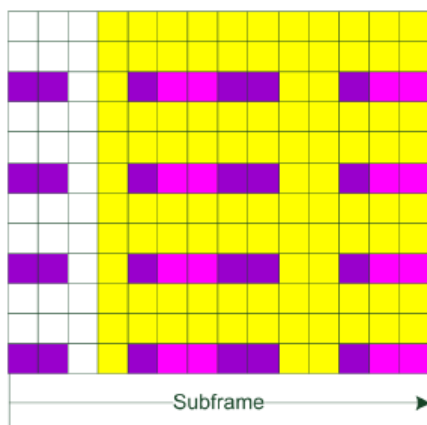

Figure 5-13: NPBCH mapping on the resource elements in SF#0 [1MA266]

- Yellow = NPBCH resource elements = 100, excluding the LTE CRS and NRS symbols and the symbols in the PDCCH region
- Violet = LTE CRS
- Magenta = NRS
- White = First three OFDM symbols are reserved for the LTE PDCCH

5.2.5 NPDCCH

The narrowband physical downlink control channel (NPDCCH) controls the data transfer between UE and eNB. It indicates the UE for that the NPDSCH carries data, the data allocation and the number of times it is repeated. NPDCCH is QPSK modulated.

NPDCCH is transmitted on an aggregation of one or two consecutive narrowband control channel elements (NCCE), distinguished by their NCCE index. Each NCCE is defined as a set of 6 subcarriers and occupies two slots. NPDCCH can occupy one or two NCCEs, where the first case is referred to as NPDCCH format 0 and the later as NPDCCH format 1.

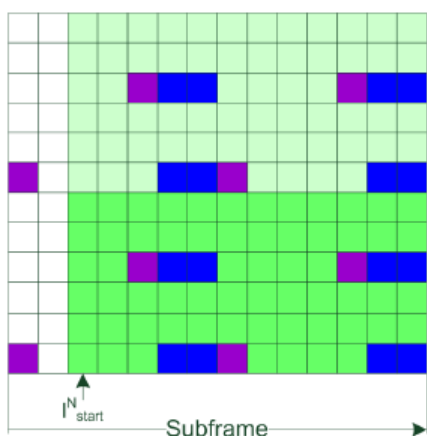

Figure 5-14: NPDCCH mapping [1MA266]

Green	= NPDCCH resource elements (NCCE#0 and NCCE#1), excluding the LTE CRS and NRS symbols and the symbols in the PDCCH region
Violet	= LTE CRS
Blue	= NRS
White	= OFDM symbols are reserved for the LTE PDCCH
$I_{\text{NPDCCHStart}}$	= Start Symbol

Search spaces

NPDCCH is grouped into three search spaces:

- Type 1 common search space, used for paging
- Type 2 common search space, used for random access
- UE-specific search space

The search space defines the NPDCCH candidates that the UE has to monitor. The UE can decode only the control information on an NPDCCH that is transmitted over NCCEs within the search space the UE monitors.

An NPDCCH search space is defined at aggregation level (L) and as a set of NPDCCH candidates. Each candidate is repeated R times over consecutive NB-IoT downlink subframes, where:

- SFs used for the transmission of system messages are omitted.
- The starting subframe is calculated to fulfill the conditions listed in "[Calculating the NPDCCH starting subframe](#)" on page 355.
- The aggregation level $L = \{0, 1\}$ defines the number of NCCEs allocated for the NPDCCH (see also [Figure 5-14](#))
- The repetition R is selected per search space type from:
 - [Table 5-15](#) and
 - [Table 5-16](#)

Calculating the NPDCCH starting subframe

Possible values are calculated automatically to fulfill the:

- Validity of the subframes, see "[Valid Subframes](#)" on page 374
- Configured NB-IoT allocations, see [Chapter 5.3.2, "NPBCH, NPDCCH and NPDSCH settings"](#), on page 375
- NPDCCH condition, per search space type, as defined in :
 - Type 1 common
Determined from locations of NB-IoT paging opportunity subframe
 - Type 2 common and UE-Specific
 $(10n_f + \text{floor}(n_s/2)) \bmod T = \alpha_{\text{offset}} \cdot T$
 $T = G \cdot R_{\text{max}} \geq 4$

Where:

- n_f is the system frame number SFN
- n_s is the slot number
- G is search space start subframe
- R_{Max} is max number of NPDCCH repetitions

- α_{offset} is the search space offset

G , R_{Max} and α_{offset} are search space-specific value, set with the following settings:

- UE-Specific, see "UE-Specific Search Space" on page 379
- Type 2 common, see "Common Search Space" on page 378

Table 5-15: Type 1 common search space NPDCCH candidates [TS 36.213]

R_{Max}	R								NCCE indices of monitored NPDCCH candidates L = 2
"Repetitions of DCI"	000	001	010	011	100	101	110	111	
1	1								{0,1}
2	1	2							{0, 1}
4	1	2	4						{0, 1}
8	1	2	4	8					{0, 1}
16	1	2	4	8	16				{0, 1}
32	1	2	4	8	16	32			{0, 1}
64	1	2	4	8	16	32	64		{0, 1}
128	1	2	4	8	16	32	64	128	{0, 1}
256	1	4	8	16	32	64	128	256	{0, 1}
512	1	4	16	32	64	128	256	512	{0, 1}
1024	1	8	32	64	128	256	512	1024	{0, 1}
2048	1	8	64	128	256	512	1024	2048	{0, 1}

Table 5-16: UE-specific and Type 2 common search space NPDCCH candidates

R_{Max}	R	"Repetitions of DCI"	NCCE indices of monitored NPDCCH candidates L = 2	UE-specific search space only NCCE indices of monitored NPDCCH candidates L = 1
1	1	00	{0,1}	{0}, {1}
2	1	00	{0, 1}	{0}, {1}
2	2	01	{0, 1}	-
4	1	00	{0, 1}	-
4	2	01	{0, 1}	-
4	4	10	{0, 1}	-
≥ 8	$R_{\text{Max}}/8$	00	{0, 1}	-
≥ 8	$R_{\text{Max}}/4$	01	{0, 1}	-
≥ 8	$R_{\text{Max}}/2$	10	{0, 1}	-
≥ 8	R_{Max}	11	{0, 1}	-

DCI formats, decoding and content

Table 5-17 gives an overview of the defined DCI formats.

Table 5-17: DCI formats

DCI format	Size, bits	Purpose	User / RNTI	Search space
N0	23	Scheduling of NPUSCH in one UL cell	User x (C-RNTI)	UE-specific Type 2 common
N1	23	Scheduling of one NPUSCH codeword in one cell Random access procedure initiated by an NPUSCH order	User x (C-RNTI) RA-RNTI	UE-specific Type 2 common
N2	15	Paging and direct indication	P-RNTI	Type 1 common

The DCI formats decoding is as follows:

- Scrambling with P-RNTI: DCI format N2
- Scrambling with RA-RNTI: DCI format N1
- Scrambling with C-RNTI: evaluated is the first bit called flag for format N0/format N1 differentiation:
 - First bit = 0: N0
 - First bit = 1: N1

Among other, the DCIs carry information on scheduling delay I_{Delay} , where scheduling delay is the time between the NPDCCH end and the NPDSCH or NPUSCH start.

When signaled over DCI format N0 and N1:

- $I_{\text{Delay}}^{\text{NPDSCH}} \geq 5 \text{ SFs}$
- $I_{\text{Delay}}^{\text{NPUSCH}} \geq 8 \text{ SFs}$

In DCI format N2, $I_{\text{Delay}}^{\text{NPDSCH}} = 5 \text{ SFs}$

Example: NPDCCH candidates calculation

- Current frame $n_f = 16$ and subframe = 0 (16, 0)
- $R_{\text{Max}} = 4$
- $G = 4$
- $\alpha_{\text{offset}} = 1/8$
- $T = G \cdot R_{\text{Max}} = 16$
- $(10n_f + \lfloor n_s/2 \rfloor) \bmod T = \alpha_{\text{offset}} \cdot T = 2$

The following starting subframes fulfill the condition:

- For $R = 1$: (16, 2), (16, 3), (16, 4) and (16, 6)
- For $R = 2$: (16, 2), (16, 4)
- For $R = 4$: (16, 2)

Example: NPDCCH scheduling based on DCI format N1

- "Search Space = UE-specific"
 - $R_{max} = 4$
 - $G = 1.5$
 - $\alpha_{offset} = 1/8$
- "Repetitions of DCI Subframes = 2" and therefore $R = 4$
- NPDCCH "Start Subframe = 2"
 - (See also [Example"NPDCCH candidates calculation"](#) on page 357)

NPDCCH is transmitted in four subframes, where the first subframe is subframe 2.

Figure 5-15 shows this configuration as observed on the "Timeplan".

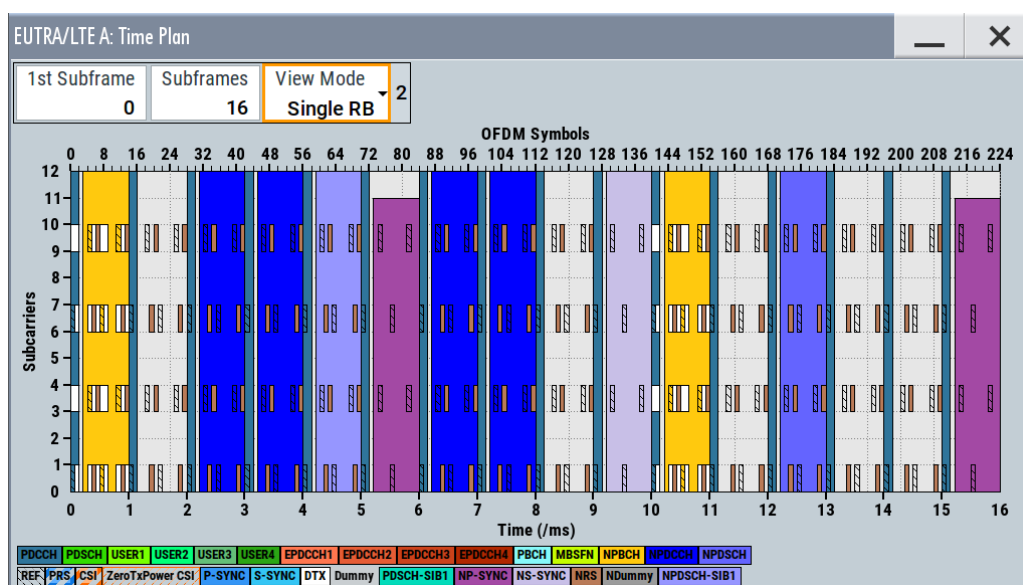

Figure 5-15: NPDCCH scheduling based on DCI format N1

NPDCCH is not allocated in subframe#4 because this subframe is reserved for the SIB1-NB transmission over NPDSCH.

For details, observe the NB-LoT allocation information in [NB-LoT Allocation](#) dialog.

5.2.6 NPDSCH

The narrowband physical downlink shared channel (NPDSCH) transmits signal information other than MIB. The channel is QPSK modulated, has the same structure as the NPDCCH (see [Figure 5-14](#)) and the same conditions apply for the $I_{NPDSCHStart}$.

NPDSCH is mapped to N_{SF}^{NPDSCH} number of subframes, where each mapped subframe is repeated N_{Rep}^{NPDSCH} times. One NPDSCH transmission lasts $N_{SF}^{NPDSCH} * N_{Rep}^{NPDSCH}$ subframes. NPDSCH transmission starts at least 5 subframes after the NPDCCH and can be additionally delayed by number of subframes k_0 , where k_0 is referred as scheduling delay. The maximum transport block size TBS is 680 bits.

SIB1-NB

NPDSCH carries the system information SIB1-NB. The message is repeated 4, 8 or 16 times, has a period of 256 frames and predefined TBS of up to 680 bits. It is transmitted on subframe SF#4 of every second frame in a number of consecutive frames, depending on the selected repetition interval.

SIB1-NB can be modified at each modification period of 4096 frames, where the modification is indicated in DCI format N2.

NPDSCH scheduling

Scheduling and TBS depend on whether the NPDSCH carries SIB1-NB message or not:

- No SIB1-NB
The N_{SF} , N_{Rep} and k_0 values are defined with the "Resource Assignment I_{SF} ", "Repetition Number I_{Rep} " and "Scheduling Delay I_{Delay} " fields in the DCI format. See [Table 5-26](#), [Table 5-27](#) and [Table 5-25](#) for the corresponding mapping.
- SIB1-NB
 - NPDSCH number of repetitions N_{Rep}^{NPDSCH} is set with the `schedulingInfoSIB1` parameter of MIB-NB.
 - The starting frame in that the SIB1-NB (i.e. NPDSCH) is transmitted is defined as function of the N_{Rep}^{NPDSCH} and the NCell ID N_{ID}^{Cell} .

Example: NPDSCH scheduling based on DCI format N1

This example extends the configuration described in [Example "NPDCCH scheduling based on DCI format N1"](#) on page 358.

- "Search Space = UE-specific" with $R_{max} = 4$
- DCI format N1 configuration:
 - $I_{SF}^{NPDSCH} = 2$ therefore $N_{SF} = 3$
 - $I_{Rep}^{NPDSCH} = 2$ therefore $N_{Rep} = 4$
 - $I_{Delay} = 2$ therefore $k_0 = 8$

NPDSCH is transmitted over $N_{SF}^{NPDSCH} * N_{Rep}^{NPDSCH} = 12$ consecutive subframes, where the first NPDSCH subframe is $5 + 8 = 13$ subframes after the NPDCCH transmission.

[Figure 5-16](#) shows this configuration as observed on the "Timeplan".

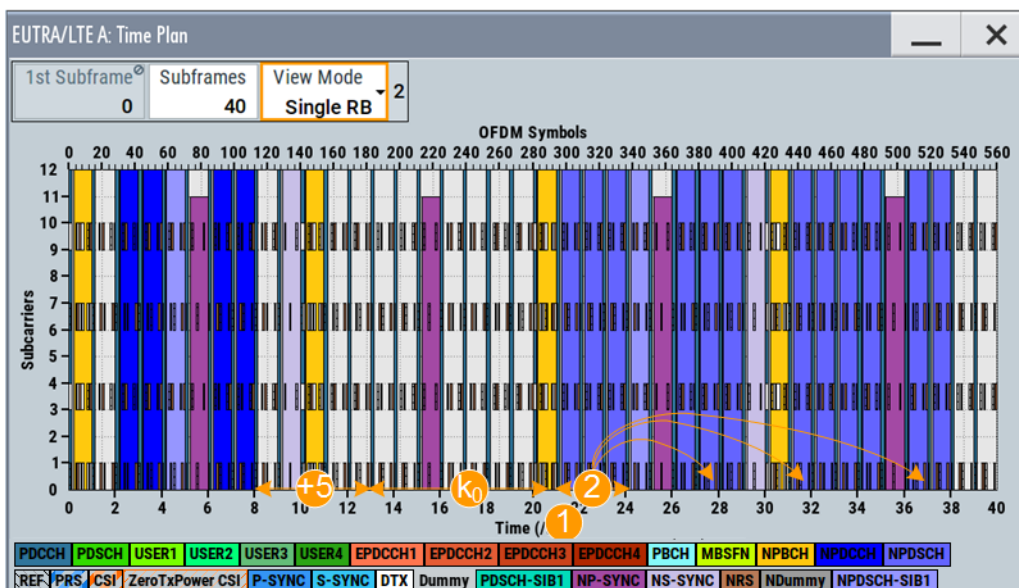

Figure 5-16: NPDSCH scheduling based on DCI format N1

- +5 = NPDSCH starts at least five subframes after NPDCCH
- K_0 = Eight subframes additional delay (because $I_{Delay} = 2$)
- 1 = NPDSCH start subframe = 21 (5 + 8 = 13 SFs after NPDCCH); SF#20 is used for NPSS
- 2 = NPDSCH is transmitted over three consecutive subframes, that in turn are repeated four times

In TDD duplexing mode, NPDSCH is transmitted in the downlink or in the DwPTS symbols. Observe the timeplan for current allocation.

5.2.7 NDRS

The narrowband demodulation reference signals (NDRS) are transmitted in the resources units containing data transmission. NDRS uses the same modulation as the associated data. All transmissions use a single antenna port, because MIMO is not defined for the UL direction.

The NDRS allocation, both as slot assignment and duration, depends on the used NPUSCH format and subcarrier spacing, see Table 5-18.

Table 5-18: NDRS duration and symbol assignment depending on the NPUSCH format and subcarrier spacing [TS 36.211]

NPUSCH format	NDRS duration (symbol per slot)	Symbol assignment for subcarrier spacing	Symbol assignment for subcarrier spacing	Number of subcarriers
		$\Delta f = 3.75$ KHz	$\Delta f = 15$ KHz	
F1	1	4	3	1 (@3.75kHz) 1, 3, 6, 12 (@15kHz)
F2	3	0, 1, 2	2, 3, 4	1

The NDRS is generated from a base sequence that is frequency shifted by a phase factor. If NDRS is transmitted with NPUSCH format F2, the NDRS is spread with the sequence known from LTE PUCCH formats 1, 1 and 1b.

5.2.8 NPUSCH

Other than in LTE, the NPUSCH carries the UL data, including UL control information (UCI). There is no channel like the LTE PUCCH channel defined in NB-LoT.

Resource units (RU)

In NB-LoT, the resource units (RU) are used to describe the mapping of the NPUSCH to resource element.

NPUSCH formats

TS 36.211 specifies two NPUSCH formats, each transporting the following information:

- F1: UL channel data over UL-SCH
- F2: UL control information UCI, restricted to acknowledgment of a DL transmission

For overview information of the NPUSCH formats and the number of used UL carriers per resource unit (RU), see Table 5-19.

Table 5-19: NPUSCH formats [TS 36.211]

NPUSCH format	Subcarrier spacing Δf	Number of subcarriers N_{SC}^{RU}	Number of slots N_{slots}^{UL}	RU duration, ms	Modulation	Resource elements per RU	Bits per RU
F1	3.75 KHz	1	16	32	$\pi/2$ -BPSK $\pi/4$ -QPSK	96	96 192
	15 KHz	1	16	8	QPSK	96	96 192
		3	8	4	QPSK, 16QAM	144	288
		6	4	2	QPSK, 16QAM	144	288
		12	2	1	QPSK, 16QAM	144	288
F2	3.75 KHz	1	4	8	$\pi/2$ -BPSK	16	16
	15 KHz	1	4	2	$\pi/2$ -BPSK	16	16

In the time domain, the NPUSCH transmission is defined as NPUSCH format, number of RU (N_{RU}), number of repetitions (N_{rep}^{NPUSCH}), and scheduling delay. An NPUSCH allocation is then $N_{rep}^{NPUSCH} N_{RU} N_{slots}^{UL}$ long. After the transmission of 256 ms, the NPUSCH transmission is postponed for 40 ms, see Table 5-20.

Table 5-20: NPUSCH gap duration expressed as number of slots

Subcarrier spacing	Slot length, ms	256 ms expressed as number of slots	40 ms expressed as number of slots
3.75 kHz	2	128	20
15 kHz	0.5	512	80

The RU size is not constant (Table 5-19). It is signaled with the DCI format N0, that carries also information on the NPUSCH start time, number of NPUSCH repetitions $N_{\text{Rep}}^{\text{PUSCH}}$ and subcarrier indication field (I_{SC}).

See:

- "DCI formats, decoding and content" on page 357
- "DCI Format N0" on page 383

Physical dimension of the NPUSCH allocation

Table 5-19 lists also the resource elements and the resulting physical bits per RU, depending on the modulation. This information is required for the calculation of the total physical bits per NPUSCH allocation.

The following applies:

- Resource elements per RU = Resource elements per slot per subcarrier * $N_{\text{slots}}^{\text{UL}}$ * $N_{\text{SC}}^{\text{RU}}$
Where:
 - For F1: Resource elements per slot per subcarrier = 6
 - For F2: Resource elements per slot per subcarrier = 4
- Number of bits per RU = {Resource elements per RU (for BPSK); 2 * Resource elements per RU (for QPSK)}
- Total number of physical bits per NPUSCH allocation = N_{RU} * Number of bits per RU
Where N_{RU} is set with the parameter "NB-IoT Allocation > Allocation# > Resource Units" and displayed with the parameter "Enhanced Settings > Config > Number of RU".

Example: NPUSCH configuration

The following is a simple example, intended to explain the parameters interdependency. It does not represent a meaningful configuration.

1. Select "Channel Bandwidth = 3 MHz".
2. Configure two UEs with the following settings:

NB-LoT Allocation												
Subcarrier Spacing	3.75 kHz											
Resource Block Index	5											
Mode	Number of Transmissions											
NPUSCH Format	Modulation	Enhanced Settings	Start Subframe	Start Slot	Repetitions	Res. Units	Subcarrier Indication	ACK/NACK Res. Field	No. Subcarriers	Power /dB		
1	F1	$\pi/4$ -QPSK	Config...	0	0	1	1	10	1	16	10	0.000
2	F2	$\pi/2$ -BPSK	Config...	32	16	2	1	0	1	4	38	0.000

NB-LoT Allocation												
Subcarrier Spacing	15 kHz											
Resource Block Index	5											
Mode	Number of Transmissions											
NPUSCH Format	Modulation	Enhanced Settings	Start Subframe	Start Slot	Repetitions	Res. Units	Subcarrier Indication	ACK/NACK Res. Field	No. Subcarriers	Power /dB		
1	F1	QPSK	Config...	0	0	2	3	17	6	4	6	0.000
2	F2	$\pi/2$ -BPSK	Config...	12	24	4	1	0	1	4	0	0.000

Figure 5-17: Example: NB-LoT allocations of two UEs with carrier spacing of 3.75 kHz and 15 kHz in the same resource block (Resource Block Index = 5)

- 1 = UE1: $\Delta f = 3.75$ kHz, two NPUSCH transmissions with F1 and F2, "Resource Block Index = 5"
- 2 = UE2: $\Delta f = 15$ kHz, two NPUSCH transmissions with F1 and F2, "Resource Block Index = 5"
- 3a, 3b = "Start Subframe" - offsets the allocation start in the time domain
- 4a, 4b = Repetitions (different values per NPUSCH format and UE)
- 5 = Number of resource units (for NPUSCH F2 RU = 1; for NPUSCH F1 variable)
- 6 = "Number of Subcarriers" (for NPUSCH F2 $N_{SC}^{RU} = 1$; for NPUSCH F1 N_{SC}^{RU} depends on the "Subcarrier Indication")
- 7a, 7b = NPUSCH duration as number of slots (calculated)
- 8a, 8b = "Starting Subcarrier" - offsets the allocation in the frequency domain

3. Use the "Adjust Length" function to set the "ARB Sequence Length = 4 Frames"
4. Observe the NPUSCH and NDRS allocations in the "Time Plan":
 - a) Display subframes in the range "1st Subframe = 0" and "Subframes = 40".
 - b) Select "View Mode = Single RB".
 - c) Select "RB = Resource Block Index = 5".

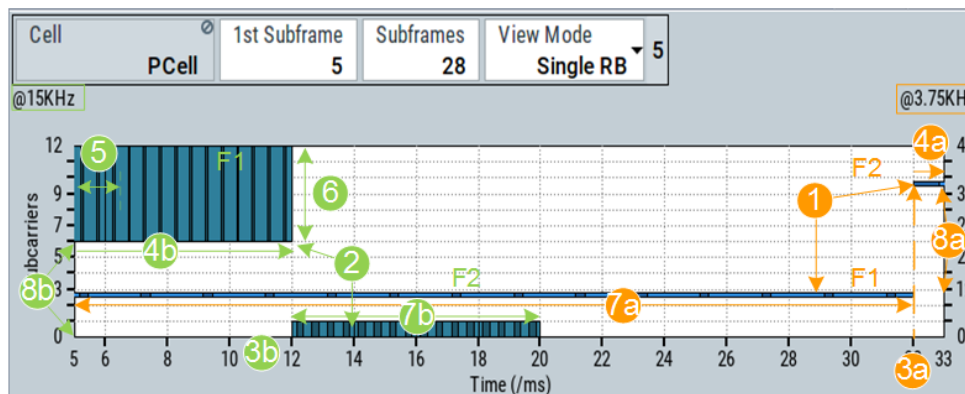

Figure 5-18: Time plan: understanding the displayed information

- 1 = NPUSCH transmissions of UE1
- 2 = NPUSCH transmissions of UE2
- 3a = NPUSCH F2 transmission of UE1 with "Start Subframe = 32"
- 3b = NPUSCH F2 transmission of UE2 with "Start Subframe = 12"
- 4a, 4b = UE1 NPUSCH F2 and UE2 NPUSCH F1 with "Repetitions = 2" (the repetitions are not shown completely)
- 5 = Resource unit RU = 3 (all other transmissions use RU = 1)
- 6 = NPUSCH F1 with $N_{SC}^{RU} = 6$; all other use $N_{SC}^{RU} = 1$
- 7a, 7b = NPUSCH F1 allocations of UE1 and UE2, both are 16 slots long; compare the time duration
- 7a = UE1 NPUSCH F1 duration = 16 slots * 1 repetition * Slot duration = 16 * 2 ms = 32 ms

- 7b = UE2 NPUSCH F2 duration = 4 slots*4 repetitions*Slot duration = 16*0.5 ms = 8 ms
 8a = "Starting Subcarrier = 10 and 38" (observe subcarrier numbering at the right y-axis ("@3.75kHz"))
 8b = "Starting Subcarrier = 6 and 0" (observe subcarrier numbering at the left y-axis ("@15kHz"))

5.2.9 NPRACH

The NPRACH channel is used during the random access procedure. One random access channel spans one subcarrier within a symbol group.

Symbol group

The term symbol group describes the set of subcarriers reserved for the narrowband random access preamble. A symbol group comprises of a cyclic prefix and five identical symbols. Four consecutive symbol groups that are repeated defined number of times ($N_{\text{rep}}^{\text{NPRACH}}$) build a preamble.

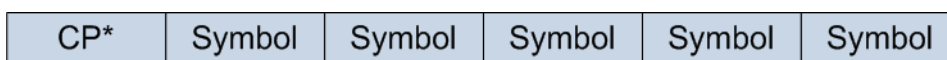

Figure 5-19: Random access symbol group

CP = Cyclic prefix (variable length)
 Symbol = Sequence of five identical symbols

NPRACH configuration

The NPRACH configuration `NPRACH-ConfigSIB-NB-r13` is signaled by higher levels with the SIB2-NB.

NPRACH is configured per coverage level and is based on the following parameters:

- NPRACH configuration index: indicates the coverage level
- NPRACH preamble format: two formats with different cyclic prefix length, where the second is four times longer than the first one.
- $N_{\text{periodicity}}^{\text{NPRACH}}$: NPRACH resource periodicity (`nprach-periodicity-r13`)
- NPRACH starting time (`nprach-StartTime-r13`)
- $N_{\text{rep}}^{\text{NPRACH}}$: number of NPRACH repetitions per preamble attempt (`maxNumPreambleAttemptCE-r13`)
- Number of NPRACH subcarriers $N_{\text{sc}}^{\text{NPRACH}}$ (`nprach-NumSubcarrierres-r13`)
- $N_{\text{scoffset}}^{\text{NPRACH}}$: frequency location of the first NPRACH subcarrier (`nprach-SubcarrierOffset-r13`)

NPRACH allocation

Depending on the preamble format, the symbol group duration is as follows:

- Preamble format 0: 1.4 ms

- Preamble format 1: 1.6 ms

The signaled parameters are sufficient to calculate the location of the first symbol group. Locations of the subsequent symbol groups are frequency hopped (shifted) versions of the first one. Their location is derived according to a predefined algorithm, that assures that hopping patterns do not overlap. The frequency hopping is applied within 12 subcarriers ($N_{SC}^{RA} = 12$).

The location of the first symbol group is given by the NPRACH starting time and the parameter n_{start} , calculated from the subcarrier index n_{int} . The subcarrier index is the resource block index for the 3.75 KHz subcarrier spacing case.

The frequency allocation of the group is calculated as follows:

- $n_{sc}^{RA}(i) = n_{start} + \tilde{n}_{SC}^{RA}(i)$

Where:

- $n_{start} = N_{scoffset}^{NPRACH} + [n_{int}/N_{sc}^{RA}] \cdot N_{SC}^{RA}$

- $\tilde{n}_{SC}^{RA}(0) = n_{int} \bmod N_{sc}^{RA}$

- $\tilde{n}_{SC}^{RA}(i) = f(\tilde{n}_{SC}^{RA}(i-1); k_h)$

Where $k_h = \{ +1, -1, +6, -6 \}$ is a hopping index that describes the frequency hopping pattern.

For details, see [TS 36.211](#).

Example: NPRACH configuration

The following is an example on the NPRACH allocation calculation.

1. Select "UL General Settings > PRACH" and configure:

- NPRACH "Preamble Format = 0"
- NPRACH "Starting Time = 8 ms"
- "NPRACH Configuration = 0" with:
 - $N_{rep}^{NPRACH} = 2$
 - $N_{sc}^{NPRACH} = 24$
 - $N_{scoffset}^{NPRACH} = 2$
- $N_{SC}^{RA} = 12$

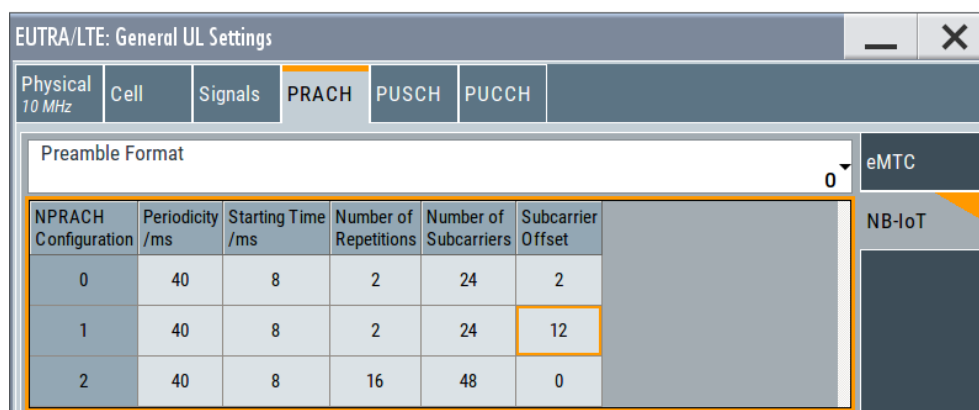

2. Select "UL Frame Configuration > UE1 > 3GPP Release = NB-IoT".

3. Select "UE1 Settings > Common > Mode = PRACH".
4. In the "NPRACH" dialog, select $n_{int} = 13$.

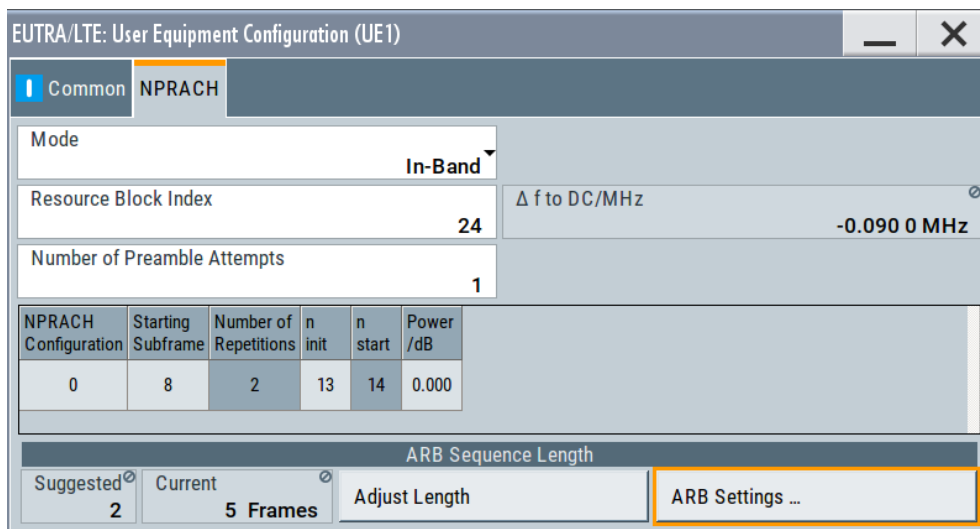

5. Open the "UL Frame Configuration > Time Plan".

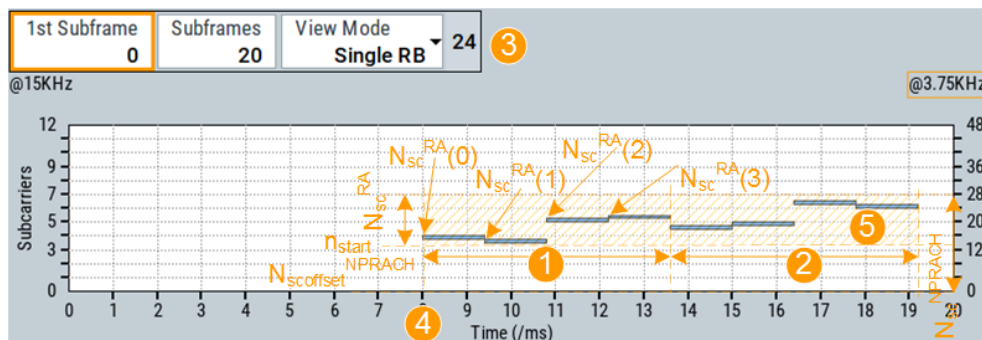

Figure 5-20: NPRACH configuration visualized in the Time Plan

- 1 = First repetition
 - 2 = Second repetition
 - 3 = "Time Plan > View Mode = Single RB", "RB# = 24" (zooms in the NPRACH allocation)
 - 4 = Starting time = 8 ms
 - 5 = NPRACH transmission area: spans $N_{sc}^{RA} = 12$ subcarriers starting from start subcarrier $n_{start} = 14$ (observe the subcarrier numbering on the right y-axis "@3.75kHz")
- $N_{sc}^{offset, NPRACH} = 2$
 $N_{sc}^{NPRACH} = 24$

The NPRACH configuration calculation in the first repetition is as follows:

- First symbol group ($i = 0$):
 - $\tilde{n}_{sc}^{RA}(0) = 13 \bmod 12 = 1$
 - $n_{start} = 2 + [13/12] \cdot 12 = 2 + 12 = 14$
 - $n_{sc}^{RA}(0) = 14 + 1 = 15$
- Second symbol group ($i = 1$):
 - $\tilde{n}_{sc}^{RA}(1) = 1 - k_h = 1 - 1 = 0$ (for details, see TS 36.211)

- $n_{sc}^{RA}(1) = 14 + 0 = 14$
- Third symbol group ($i = 2$):
 - $\tilde{n}_{sc}^{RA}(2) = 0 + 6 = 6$
 - $n_{sc}^{RA}(2) = 14 + 6 = 20$
- Fourth symbol group ($i = 3$):
 - $\tilde{n}_{sc}^{RA}(3) = 6 + 1 = 7$
 - $n_{sc}^{RA}(3) = 14 + 7 = 21$

Set the "UL General Settings > PRACH > Preamble Format = 1" and observe the changed symbol length in the "Time Plan".

5.3 eMTC/NB-LoT-specific configuration and settings

Access:

1. In the "EUTRA/LTE > General" dialog, select "**Mode > eMTC/NB-LoT**".

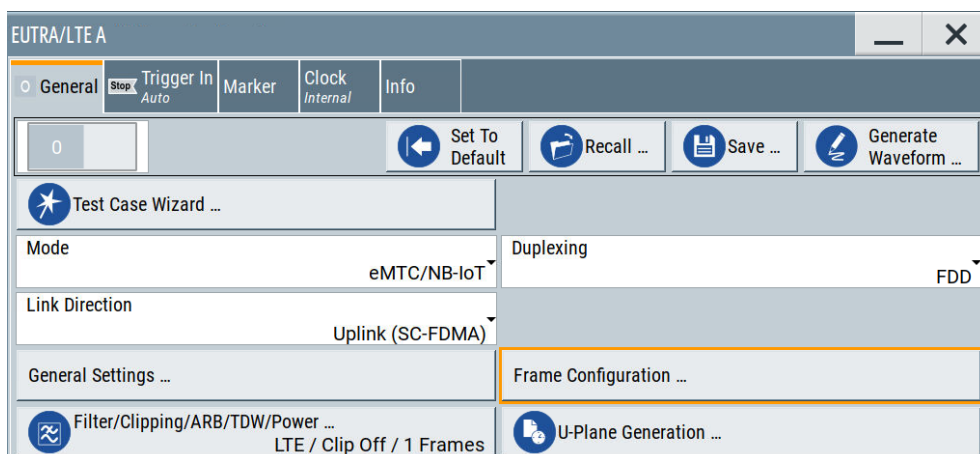

2. **To access the physical and cell-related DL settings:**
 - a) Select "Link Direction > Downlink"
 - b) Select "General Settings"
3. **To access the DL User-specific settings:**
 - a) Select "Link Direction > Downlink"
 - b) Select "Frame Configuration > General".
 - c) To access the configure the allocation of the NB-LoT DL channels, **select the "NB-LoT DCI Config" and "NB-LoT Allocation"**.

Other than in LTE, the NB-LoT allocations are not defined on a per subframe basis. The settings in the "Subframe" tab apply to LTE channels and are required only if you generate mixed LTE and loT signals.

4. **To access the physical and cell-related UL settings:**
 - a) Select "Link Direction > Uplink"

- b) Select "General Settings"
5. **To access the UL UE-specific settings:**
 - a) Select "Link Direction > Uplink"
 - b) Select "Frame Configuration > General".

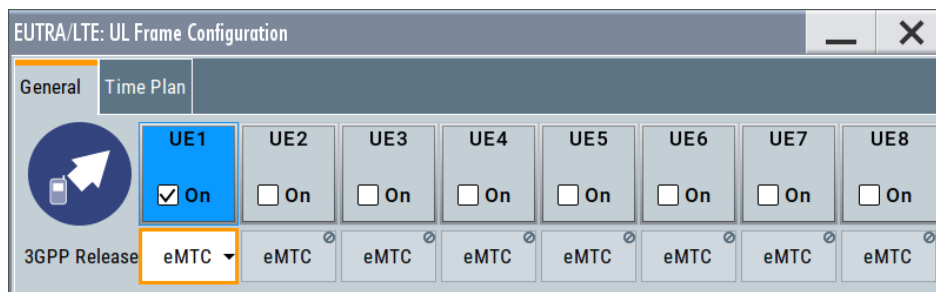

- c) To access the settings of the individual UEs, **click the "UE x" block**.

You can enable up to 4 UEs, where each UE can work in a different mode, as set with the parameter [3GPP Release](#).

Other than in LTE, the eMTC/NB-LoT allocations are dedicated UE-specific settings. They are not defined on a per subframe basis.

If you are familiar with the LTE implementation or generate mixed LTE and IoT signals, you may find it useful to access the settings also from the "Subframe" tab.

This section lists the **eMTC/NB-LoT-specific settings**. The settings that eMTC/NB-LoT reuse from LTE are described in:

[Chapter 4, "EUTRA/LTE configuration and settings"](#), on page 61

The remote commands required to define the eMTC/NB-LoT settings are described in [Chapter 10.27, "eMTC/NB-LoT commands"](#), on page 799.

• NB-LoT carrier allocation	368
• NPBCH, NPDCCH and NPDSCH settings	375
• FRC settings	405
• NDMRS settings	408
• NPUSCH settings	410
• NPRACH settings	422
• eMTC DL allocations settings	428
• eMTC PUSCH settings	458
• eMTC PUCCH settings	470
• eMTC PRACH settings	477

5.3.1 NB-LoT carrier allocation

Access:

1. Select "General > Link Direction > Downlink (OFDMA)".
2. Select "General > Duplexing > FDD".
3. Select "General DL Settings > NB-LoT".

With these settings, you configure the **anchor carrier** used by all NB-LoT channels.

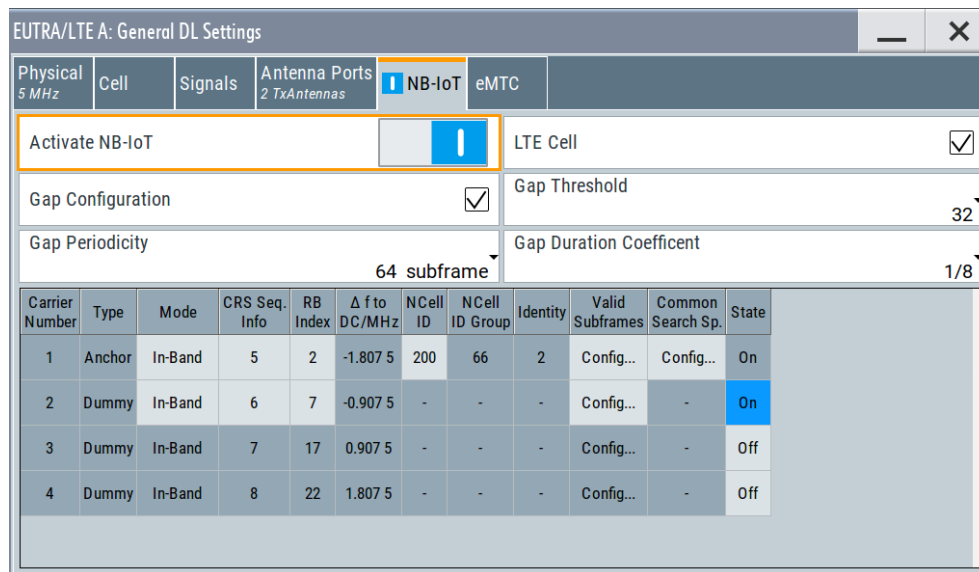

4. Define the anchor carrier in terms of operating mode, allocated resource block, used NB-LoT cell ID and valid subframes.
5. To configure the subframes that are enabled for NB-LoT transmission:
 - a) Select "Valid Subframes > Config"
 - b) For in-band operation, select, for example "Bitmap Subframes = 40"
 - c) Select a subframe (SF) to enable it for NB-LoT transmission.

Suframes in that the NPBCH, NPSS or NSSS are transmitted can not be used for other NB-LoT DL channels.
NB-LoT transmission is postponed during invalid subframes.
6. Set the "State = On" to enable each of the up to 3 **secondary carriers**.
7. Set "**Activate NB-LoT = On**" to activate the configuration.
8. To observe the NB-LoT carrier allocations, open the "Time Plan".
In standalone and in-band modes, the "Time Plan" indicates the anchor carrier.
In in-band mode, activated secondary carriers and the LTE synchronization signals PSS/SSS are also indicated.
9. To observe the anchor carrier in greater detail, set "View Mode = Single RB".

Settings:

Activate NB-LoT..... 370

LTE Cell..... 370

Gap Configuration..... 370

Gap Threshold..... 370

Gap Periodicity..... 371

Gap Duration Coefficient..... 371

Puncture LTE at Inband Carriers..... 371

Carrier Number.....	371
Type.....	371
Mode.....	371
CRS Sequence Info.....	372
RB Index.....	372
Delta Frequency to DC, MHz.....	373
NCell ID.....	373
NCell ID Group.....	373
Identity.....	373
Valid Subframes.....	374
L Mode.....	374
L Bitmap Subframes.....	375
L Select All/Deselect All.....	375
State.....	375

Activate NB-LoT

For "Physical > Channel Bandwidth \geq 3 MHz", enables the NB-LoT anchor carrier and generally the NB-LoT channels.

If disabled, all downlink NB-LoT allocations are deactivated.

Option: R&S SMM-K146

To enable NB-LoT in TDD mode, select **TDD UL/DL Configuration** = "1 to 5"

Remote command:

`[:SOURCE<hw>] :BB:EUTRa:DL:CARRier<ch>:NIOT:STATe` on page 838

LTE Cell

In "General DL Settings > NB-LoT > Mode > In-Band" operation, defines how the LTE channels are handled.

If enabled, all LTE channels are deactivated. However, LTE reference signals are still transmitted.

Remote command:

`[:SOURCE<hw>] :BB:EUTRa:DL:NIOT:LTECell:STATe` on page 832

Gap Configuration

If activated, a gap between the NPDCCH and NPDSCH with the specified duration is applied.

The gap (**DL-GapConfig**) is applied to all NPDCCH and NPDSCH transmission but BCCH, as defined in **TS 36.331**.

Remote command:

`[:SOURCE<hw>] :BB:EUTRa:DL:NIOT:GAP:CONFig:STATe` on page 832

Gap Threshold

If **Gap Configuration** > "On", sets the gap threshold, as defined in **TS 36.331**.

Remote command:

`[:SOURCE<hw>] :BB:EUTRa:DL:NIOT:GAP:THReshold` on page 833

Gap Periodicity

If [Gap Configuration](#) > "On", sets the number of subframes after that the configured gap is repeated.

Remote command:

`[:SOURCE<hw>] :BB:EUTRa:DL:NIOT:GAP:PERiodicity` on page 833

Gap Duration Coefficient

If [Gap Configuration](#) > "On", sets the gap duration coefficient, as defined in [TS 36.331](#).

Remote command:

`[:SOURCE<hw>] :BB:EUTRa:DL:NIOT:GAP:DURation:COEFFicient` on page 833

Puncture LTE at Inband Carriers

In mixed LTE and loT mode ("LTE > Mode > LTE/eMTC/NB-LoT") and in in-band or guard band operation ("General DL Settings > NB-LoT > Mode > In-Band/Guard Band"), punctures the LTE signal at the NB-LoT carriers.

Remote command:

`[:SOURCE<hw>] :BB:EUTRa:DL:NIOT:PUNcture` on page 832

Carrier Number

Indicates the NB-LoT carrier.

Remote command:

n.a.

Type

The first carrier is the anchor carrier.

Anchor carrier is the carrier where the UE assumes that NPSS/NSSS, NPBCH and SIB1-NB are transmitted.

In in-band and guard band operation, you can enable and configure up to 3 secondary carriers. The secondary carriers are filled in with dummy data.

DL NB-LoT carriers span one resource block. To observe their allocation, use the "Time Plan" with "View Mode = Single RB".

Remote command:

n.a.

Mode

Selects the operating mode, see [Figure 5-10](#).

See also [Example"Configuring an NB-LoT allocation in standalone operating mode"](#) on page 350.

"Standalone" Available if "Physical > Channel Bandwidth = 200 kHz".
All LTE allocations are automatically disabled.

"In-band/
Guardband" Available if "Physical > Channel Bandwidth ≥ 3MHz".

Remote command:

`[:SOURCE<hw>] :BB:EUTRa:DL:CARRier<ch>:NIOT:MODE` on page 833

CRS Sequence Info

For "Mode > In-Band/Guardband", sets the `eutra-CRS-SequenceInfo` parameter of the MIB-NB message.

It indicates the carrier containing NPSS/NSSS/NPBCH, where the value gives the LTE RB index.

The parameters [CRS Sequence Info](#) and [RB Index](#) are interdependent. Their values are calculated automatically according to TS 36.213.

Example: CRS sequence info and RB index values for 5MHz channel bandwidth

The following applies for example for "Physical > Channel Bandwidth = 5 MHz".

"CRS Sequence Info"	"RB Index"
5	2
6	7
7	17
8	22

Remote command:

`[:SOURCE<hw>] :BB:EUTRa:DL:CARRIER<ch>:NIOT:CRSSeq` on page 834

RB Index

Sets the resource block number in that the NB-LoT transmissions are allocated.

The available resource blocks depend on the used "Channel Bandwidth" (or "Number of Available Resource Blocks") and the operating "Mode".

Table 5-21: Resource block index value ranges

Operation mode	Resource block allocation	Value range
In-band	Within the "Channel Bandwidth"	See Table 5-22
Guard band	Left guard band	< 0
	Right guard band	> "Number of Available Resource Blocks"

Table 5-22: RB indexes allowed for NB-LoT synchronization in in-band operation

LTE system band-width	3 MHz	5 MHz	10 MHz	15 MHz	20 MHz
RB index	2, 12	2, 7, 17, 22	4, 9, 14, 19, 30, 35, 40, 45	2, 7, 12, 17, 22, 27, 32, 42, 47, 52, 57, 62, 67, 72	4, 9, 14, 19, 24, 29, 34, 39, 44, 55, 60, 65, 70, 75, 80, 85, 90, 95

The parameters [CRS Sequence Info](#) and [RB Index](#) are interdependent. Their values are calculated automatically according to TS 36.213.

Remote command:

`[:SOURCE<hw>] :BB:EUTRa:DL:CARRIER<ch>:NIOT:RBIDx` on page 834

`[:SOURCE<hw>] :BB:EUTRa:DL:CARRIER<ch>:NIOT:GBRBidx` on page 835

Delta Frequency to DC, MHz

In "Mode > In-band/Guard Band", indicates the delta frequency with that the NB-LoT carrier is offset from the LTE center frequency.

The value depends on "RB Index" and in in-band mode and per default in the guard-band mode it is calculated as follows:

$$\text{"Delta Frequency to DC"} = \Delta f_{\text{NB-LoT}} * (\text{"RB Index"} * N_{\text{SC}}^{\text{RB}} - \text{floor}(N_{\text{RB}}^{\text{DL}} * N_{\text{SC}}^{\text{RB}} / 2) + N_{\text{SC}}^{\text{RB}} / 2) \pm 7500$$

Where:

- $\Delta f_{\text{NB-LoT}} = 15$ kHz is the NB-LoT subcarrier spacing
- $N_{\text{RB}}^{\text{DL}}$ is the "Number of Resource Blocks per Slot"
- $N_{\text{SC}}^{\text{RB}} = 12$ is the number of subcarrier per RB
- ± 7500 is a frequency shift of half subcarrier bandwidth to avoid the center frequency

Thus, the possible values for the center frequencies of the NB-LoT channels are at 180 kHz offset to each other. In guard band mode, you can change this spacing and set different "Delta Frequency to DC". If the set value does not correspond to a valid RB index, then the "RB Index = User".

According to the specification, the center frequencies of the NB-LoT channels in guard band mode must satisfy the following conditions:

- The first allocated NB-LoT RB must be orthogonal to the LTE RBs, whereas the following NB-LoT can be at 180 kHz or 15 kHz offset.
- The center frequencies of the NB-LoT carriers must satisfy the EARFCN conditions and hence be an integer multiple of 100 kHz; a raster of ± 2.5 kHz and ± 7.5 kHz is allowed, too.

Remote command:

[\[:SOURCE<hw>\]:BB:EUTRa:DL:CARRIER<ch>:NIOT:DFREQ](#) on page 834

NCell ID

Sets the narrowband physical cell identifier, $N_{\text{Cell ID}}^{\text{NCell}}$.

Defined are 504 unique physical layer cell identities (NCell ID), where the NSSS carries the $N_{\text{Cell ID}}^{\text{NCell}}$ value.

Remote command:

[\[:SOURCE<hw>\]:BB:EUTRa:DL:CARRIER<ch>:NIOT:CELL](#) on page 834

NCell ID Group

Indicates the physical cell identity group.

Remote command:

[\[:SOURCE<hw>\]:BB:EUTRa:DL:CARRIER<ch>:NIOT:CIDGROUP](#) on page 835

Identity

Indicates the identity of the physical layer within the "NCell ID Group".

Remote command:

[\[:SOURCE<hw>\]:BB:EUTRa:DL:NIOT:ID?](#) on page 835

Valid Subframes

Sets the subframes bitmap carried by SIB1-NB (`downlinkBitmap-r13`) and defines the valid subframes (SF) that can be used for NB-LoT transmission.

If an SF is set to invalid or it contains NPSS, NSSS, NPBCH, or SIB1-NB, the NB-LoT transmission is postponed during this SF.

The selected subframes influence the scheduling of the NB-LoT transmissions.

EUTRA/LTE A: DL NB-LoT Valid Subframes (1)					
Mode		In-Band			Bitmap Subframes
Select All		Deselect All			40
NPBCH	SF1	SF2	SF3	SF4	
<input type="checkbox"/> On	<input checked="" type="checkbox"/> On	<input checked="" type="checkbox"/> On	<input checked="" type="checkbox"/> On	<input checked="" type="checkbox"/> On	
NP-SYNC	SF6	SF7	SF8	NS-SYNC	
<input type="checkbox"/> On	<input checked="" type="checkbox"/> On	<input checked="" type="checkbox"/> On	<input checked="" type="checkbox"/> On	<input type="checkbox"/> On	
NPBCH	SF11	SF12	SF13	SF14	
<input type="checkbox"/> On	<input type="checkbox"/> On	<input type="checkbox"/> On	<input type="checkbox"/> On	<input type="checkbox"/> On	
NP-SYNC	SF16	SF17	SF18	SF19	
<input type="checkbox"/> On	<input type="checkbox"/> On	<input type="checkbox"/> On	<input type="checkbox"/> On	<input type="checkbox"/> On	
NPBCH	SF21	SF22	SF23	SF24	
<input type="checkbox"/> On	<input checked="" type="checkbox"/> On	<input checked="" type="checkbox"/> On	<input checked="" type="checkbox"/> On	<input checked="" type="checkbox"/> On	
NP-SYNC	SF26	SF27	SF28	NS-SYNC	

According to TS 36.213, the valid SF in the secondary carriers (DL-CarrierConfigDedicated-NB-r13) can be defined in one of the following ways:

- No bitmap defined means that all DL subframes are valid
- To apply the bitmap of the anchor carrier
- To define an explicit bitmap configuration per secondary carrier.

In this implementation, the valid subframes in the secondary carriers are set individually.

Remote command:

`[:SOURCE<hw>] :BB:EUTRa:DL:CARRIER<ch>:NIOT:NVSF` on page 835

`[:SOURCE<hw>] :BB:EUTRa:DL:CARRIER<ch>:NIOT:SF<st0>:VALSf`

on page 836

Mode ← Valid Subframes

Indicates the operation mode of the selected carrier.

Bitmap Subframes ← Valid Subframes

Sets the valid subframes configuration over 10ms or 40ms (subframePattern10-r13, subframePattern40-r13), where 40ms configuration is available in the in-band mode.

Remote command:

[:SOURCE<hw>] :BB:EUTRa:DL:CARRier<ch>:NIOT:NVSF on page 835

Select All/Deselect All ← Valid Subframes

Sets all SFs to valid or invalid SFs.

Remote command:

[:SOURCE<hw>] :BB:EUTRa:DL:CARRier<ch>:NIOT:SFAll on page 836

[:SOURCE<hw>] :BB:EUTRa:DL:CARRier<ch>:NIOT:SFNN on page 836

State

Enables secondary NB-LoT carrier.

Remote command:

[:SOURCE<hw>] :BB:EUTRa:DL:CARRier<ch>:NIOT:STAtE on page 838

5.3.2 NPBCH, NPDCCH and NPDSCH settings

Access:

1. Select "General > Link Direction > Downlink".
2. To configure the **common and UE-specific search spaces**:
 - a) Select "General DL Settings > NB-LoT Carrier Allocation > Common Search Space".

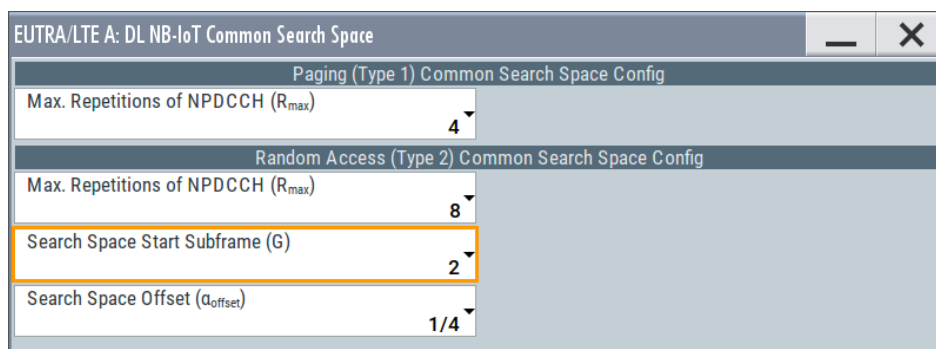

- b) Select "Frame Configuration > General > User Configuration > UEx > Search Space > Config".

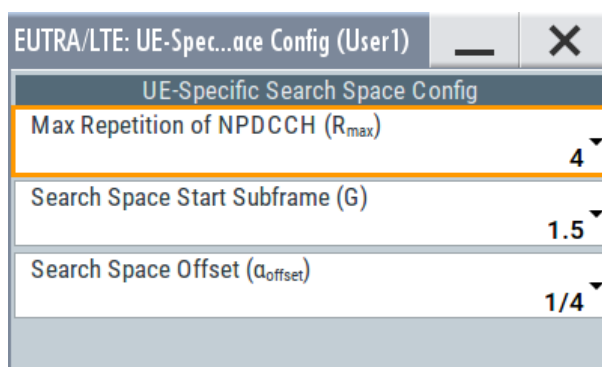

3. Enable at least one NB-LoT UE, i.e. select "Frame Configuration > General > User > User 3" > "3GPP Release = NB-LoT".
4. To adjust the **DCI content** for example to configure the **NPDSCH and NPDCCH scheduling**:
- Select "Frame Configuration > NB-LoT > DCI Configuration".
 - Select "Number of DCI Allocations = 1".
 - Configure the DCI allocations, for example the DCI of one of the NB-LoT UEs: "User > User 3", "DCI Format = N1", "Search Space = UE-Specific".

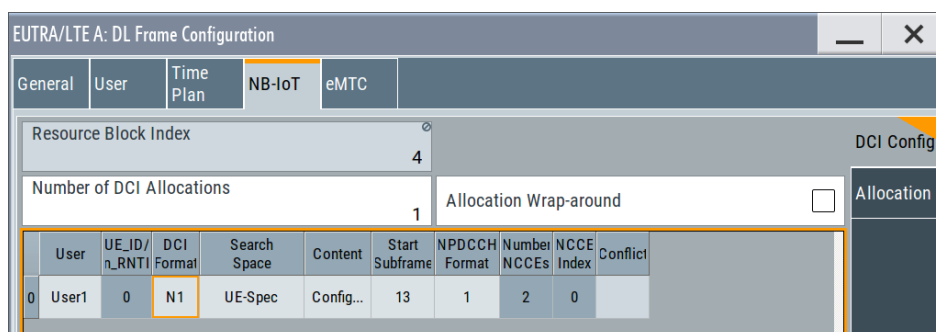

- Select "Content > Config".
 - In the "DCI Format Configuration" dialog, set "Repetitions of DCI Subframe = 2", $I_{SF}^{NPDSCH} = 2$, $I_{Rep}^{NPDSCH} = 2$ and $I_{Delay} = 2$
 - Observe the information on the resulting configuration:
"Repetitions of NPDCCH (R) = 4", "Repetitions of NPDSCH (N_{Rep}) = 4", "Number of NPDSCH Subframes (N_{SF}) = 4"
 - In the "NB-LoT > DCI Configuration" dialog, set a "Start Subframe".
5. To display the automatically configured **NPBCH, NPDCCH and NPDSCH allocations in the anchor carrier** according to the current DCI configuration:

- a) Select "Frame Configuration > NB-LoT > Allocation".

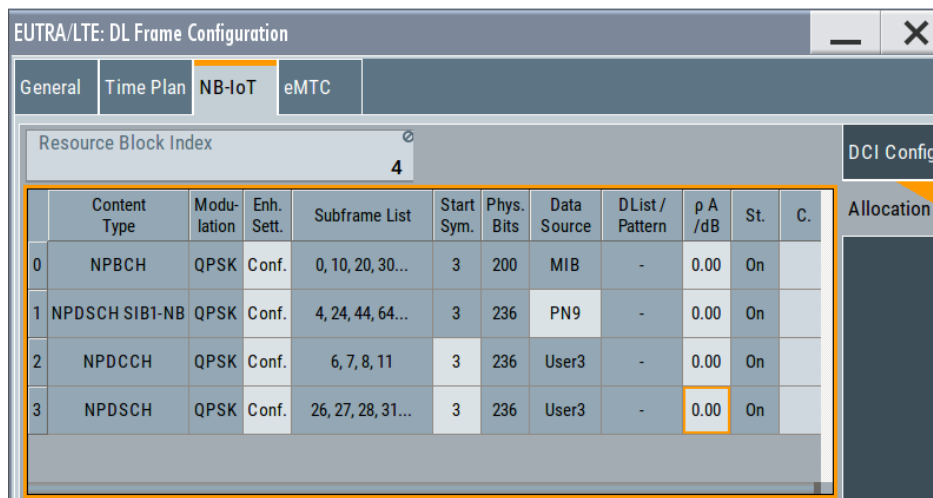

- b) For the NPDCCH and NPDSCH allocations, observe the subframes displayed in the "Subframe List".

- 6. Observe the NB-LoT channels and signals on the "Time Plan".

See the example on [Figure 5-16](#).

The time plan confirms the NPDCCH start subframe and the subframes in that NPDCCH is transmitted.

It also confirms the that the NPDSCH allocation starts with the defined shedding delay after the NPDCCH allocation and spans the configured number of subframes.

- 7. To change information in the **MIB-NB**, like for example the **SIB1-NB scheduling**, select "NPBCH > Enhanced Settings > Config".

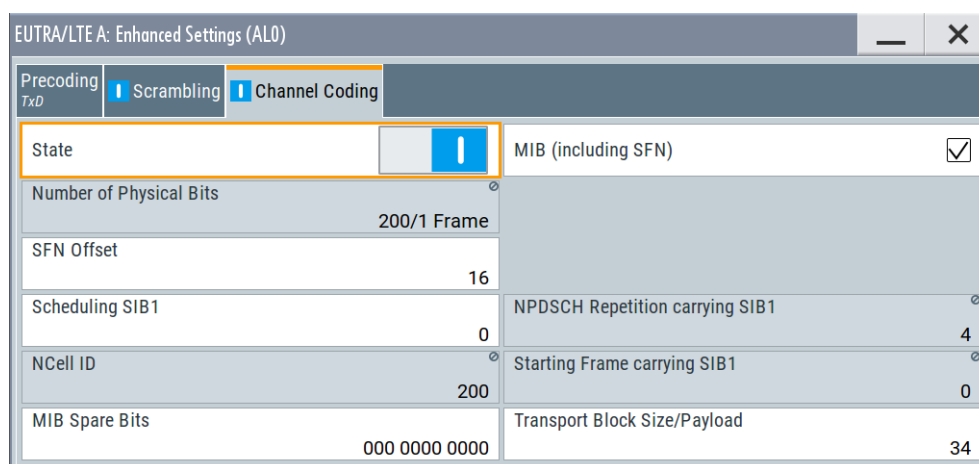

See [Chapter 5.3.2.4, "NPBCH channel coding and MIB-NB configuration"](#), on page 398.

Settings:

- [Search space settings](#).....378
- [NB-LoT DCI configuration](#).....379
- [NB-LoT allocations \(NPBCH, NPDCCH, NPDSCH\)](#).....393
- [NPBCH channel coding and MIB-NB configuration](#).....398
- [NPDSCH and NPDCCH channel coding and scrambling](#).....402

5.3.2.1 Search space settings

Access:

1. Select "General > Link Direction > Downlink".
2. Select "General DL Settings > NB-LoT Carrier Allocation > Common Search Space".
3. Select "Frame Configuration > General > User Configuration > UEx > Search Space > Config"

Settings:

Common Search Space	378
L Max. Repetitions of NPDCCH (Rmax) for Type 1 common search space	378
L Max. Repetitions of NPDCCH (Rmax) for Type 2 common search space	378
L Search Space Start Subframe (G)	379
L Search Space Offset (α_{offset})	379
UE-Specific Search Space	379
L Max. Repetitions of NPDCCH (Rmax) (UE-specific search space)	379
L Search Space Start Subframe (G)	379
L Search Space Offset (α_{offset})	379

Common Search Space

Configures the Type 1 (paging) and Type 2 (random access) common search space.

The common search space defines the NPDCCH candidates that the UE has to monitor, see "[Search spaces](#)" on page 355.

Max. Repetitions of NPDCCH (Rmax) for Type 1 common search space ← Common Search Space

Sets the maximum number NPDCCH is repeated R_{Max}
(npdcch-NumRepetitionPaging-r13).

Remote command:

[:SOURCE<hw>] :BB:EUTRa:DL:NIOT:PAG:RMAX on page 837

Max. Repetitions of NPDCCH (Rmax) for Type 2 common search space ← Common Search Space

Sets the maximum number NPDCCH is repeated R_{Max}
(npdcch-NumRepetitions-RA-r13).

Remote command:

[:SOURCE<hw>] :BB:EUTRa:DL:NIOT:RAND:RMAX on page 837

Search Space Start Subframe (G) ← Common Search Space

Sets the start SF for the random access common search space (npdcch-StartSF-CSS-RA-r13).

The following applies:

$$G \cdot R_{\text{Max}} \geq 4$$

Remote command:

[:SOURCE<hw>] :BB:EUTRa:DL:NIOT:RAND:STSFrame on page 837

Search Space Offset (α_{offset}) ← Common Search Space

Shifts the search space start (npdcch-Offset-RA-r13).

Remote command:

[:SOURCE<hw>] :BB:EUTRa:DL:NIOT:RAND:SSOffset on page 837

UE-Specific Search Space

Configures the user-specific search space.

Max. Repetitions of NPDCCH (Rmax) (UE-specific search space) ← UE-Specific Search Space

Sets the maximum number NPDCCH is repeated R_{Max} (npdcch-NumRepetitions-r13).

Remote command:

[:SOURCE<hw>] :BB:EUTRa:DL:USER<ch>:NIOT:RMAX on page 864

Search Space Start Subframe (G) ← UE-Specific Search Space

Sets the start SF for the random access common search space (npdcch-StartSF-USS-r13).

The following applies:

$$G \cdot R_{\text{Max}} \geq 4$$

Remote command:

[:SOURCE<hw>] :BB:EUTRa:DL:USER<ch>:NIOT:STSFrame on page 864

Search Space Offset (α_{offset}) ← UE-Specific Search Space

Shifts the search space start (npdcch-Offset-USS-r13).

Remote command:

[:SOURCE<hw>] :BB:EUTRa:DL:USER<ch>:NIOT:SSOffset on page 864

5.3.2.2 NB-IoT DCI configuration

Access:

1. Select "General > Link Direction > Downlink".

2. Enable at least one NB-LoT UE, i.e. select "Frame Configuration > General > User > User 3" > "**3GPP Release = NB-LoT**".
3. Select "Frame Configuration > NB-LoT > DCI Configuration".

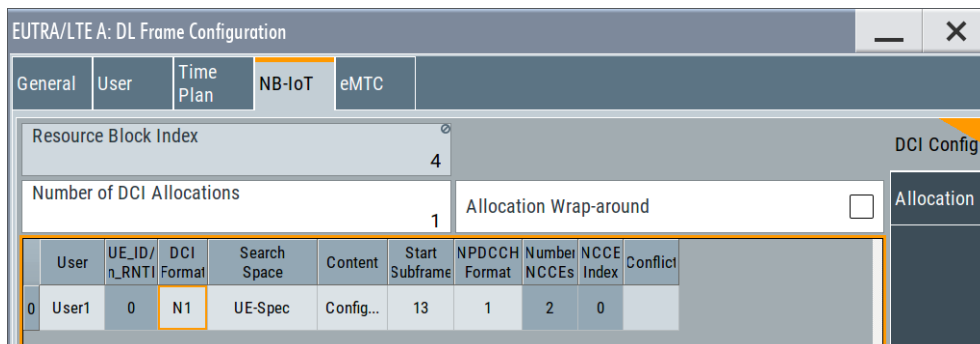

4. Select "Number of DCI Allocations = 1".
5. Configure the DCI allocations, e.g. select "User > User 3" and select "Start Subframe = 6"
6. For each DCI, select "Content > Config".

Settings:

Resource Block Index..... 380

Number of DCI Allocations..... 381

Allocation Wrap-around..... 381

User..... 381

UE_ID/n_RNTI..... 381

DCI Format..... 381

Search Space..... 382

DCI Content Configuration..... 382

- L Bit Data..... 383
- L DCI Format N0..... 383
- L DCI Format N1..... 385
- L DCI Format N2..... 389
- L Distance from NPDCCH to NPDSCH..... 391
- L Transport Block Size..... 391
- L Number of Resource Units (N_{RU})..... 391
- L Number of NPDSCH Subframes (N_{SF})..... 392
- L Repetitions of NPDSCH (N_{Rep})..... 392
- L Repetitions of NPDCCH (R)..... 392

Start Subframe..... 392

NPDCCH Format..... 392

Number NCCEs..... 393

NCCE Index..... 393

Conflict..... 393

Resource Block Index

Indicates the resource block number of the anchor NB-LoT carrier.

The value is set with the parameter [RB Index](#).

Number of DCI Allocations

Sets up to 100 configurable DCIs.

There is one table row per DCI in the DCI table.

The default "Number of DCI Allocations" value depends on the availability of NB-IoT users:

- 0: if all "User" are set to eMTC.
Changing the value to "Number of DCI Allocations = 1", enables you to configure P-RNTI or RA-RNTI DCIs.
- 1: if there is at least one "User" with "3GPP Release = NB-IoT".

Set "Number of DCI Allocations = 0" to disable the DCI-based NB-IoT configuration.

Remote command:

[\[:SOURCE<hw>\]:BB:EUTRa:DL:NIOT:DCI:NALLoc](#) on page 844

Allocation Wrap-around

An NPDCCH can schedule a NPDSCH outside of the selected "ARB Sequence Length".

Enable this parameter to ensure a consistent signal, where the NPDSCH allocations are relocated at the beginning of the ARB sequence.

[\[:SOURCE<hw>\]:BB:EUTRa:DL:NIOT:DCI:AWARound](#) on page 844

User

Selects the user the DCI is dedicated to. The available DCI formats depend on the value of this parameter.

Other than in LTE, there is no NPDCCH indication of the system information (SI-RNTI).

"User x" Selects one of the four users with "3GPP Release = NB-IoT", as configured in the "Frame Configuration > General > User" dialog.

"P-RNTI/RA-RNTI"
 A group of users is selected.

Remote command:

[\[:SOURCE<hw>\]:BB:EUTRa:DL:NIOT:DCI:ALLoc<ch0>:USER](#) on page 844

UE_ID/n_RNTI

Displays the UE_ID of the "User x" or the n_RNTI for the selected DCI.

The UE_ID is set with the parameter "Frame Configuration > General > User Configuration > User x" > [UE ID/n_RNTI](#).

Remote command:

[\[:SOURCE<hw>\]:BB:EUTRa:DL:NIOT:DCI:ALLoc<ch0>:UEID?](#) on page 844

DCI Format

Sets the DCI format for the selected allocation.

The downlink control information (DCI) is a message used to control the physical layer resource allocation in the UL and DL direction. It carries scheduling information and uplink power control commands.

Depending on the DCI message usage, they are categorized into three different formats: N0, N1 and N2.

See "[DCI formats, decoding and content](#)" on page 357.

To configure the parameters per DCI format, select "Content > Config".

Remote command:

[\[:SOURCE<hw>\]:BB:EUTRa:DL:NIOT:DCI:ALLoc<ch0>:FMT](#) on page 845

Search Space

Defines the search space for the selected DCI.

The search space defines the NPDCCH candidates that the UE has to monitor. The UE can decode only the control information on an NPDCCH that is transmitted over NCCEs within the search space the UE monitors.

[Table 5-23](#) lists different scheduling situations and the required configuration of "Search Space" and [DCI Format](#).

Table 5-23: Scheduling situation

Situation	"DCI Format"	"Search Space"
NPDCCH and NPDSCH configured by P-RNTI	N2	Type 1 common
NPDCCH and NPDSCH configured by RA-RNTI	N1	Type 2 common
NPDCCH and NPDSCH configured by C-RNTI	N1	UE-specific by C-RNTI
NPDCCH and NPDSCH configured by temporary C-RNTI and/or C-RNTI during random access procedure	N1	Type 2 common
NPDCCH and NPUSCH configured by C-RNTI	N0	UE-specific by C-RNTI
NPDCCH configured as "PDCCH order" to initiate random access procedure	N1	UE-specific by C-RNTI
NPDCCH and NPUSCH configured by temporary C-RNTI and/or C-RNTI during random access procedure	N0	Type 2 common

"UE-spec" Non-common DCIs are mapped to the UE-specific search space. Each UE has multiple UE-specific search spaces, determined as a function of the UE ID and the subframe.

"Type 1 Common/Type 2 Common"

The DCI is mapped to the common search space, where Type 1 common search space is used for paging and Type 2 for random access. A common search space is used to address all or a group of UEs.

Remote command:

[\[:SOURCE<hw>\]:BB:EUTRa:DL:NIOT:DCI:ALLoc<ch0>:SSP](#) on page 845

DCI Content Configuration

Configure the parameters per DCI format.

The fields defined in the DCI format are mapped to the information bits according to the 3GPP specification.

The resulting "Bit Data", N_{SF} , N_{Rep} and R values are displayed.

Bit Data ← DCI Content Configuration

Displays the resulting bit data as selected with the DCI format parameters.

The first bit in DCI formats N0 and N1 is used as flag to distinguish between the two formats. It is set as follows:

- DCI format N0: First bit = 0
- DCI format N1: First bit = 1

Mapping of the information bits is according to [TS 36.212](#).

See also "[DCI formats, decoding and content](#)" on page 357.

Remote command:

`[:SOURCE<hw>] :BB:EUTRa:DL:NIOT:DCI:ALLoc<ch0>:BITS?` on page 847

DCI Format N0 ← DCI Content Configuration

The DCI format N0 is 23-bits long and used for scheduling of NPUSCH in one UL cell.

EUTRA/LTE A: DCI Format Configuration (1)	
Bit Data	0000 0000 0000 0000 0000 0000
DCI Format N0	
Subcarrier Indication Field of NPUSCH (I_{SC})	Resource Assignment Field of NPUSCH (I_{RU})
0	0
Scheduling Delay Field (I_{Delay})	Modulation and Coding Scheme (I_{MCS})
0	0
Redundancy Version	Number of NPUSCH Repetitions Field (I_{REP})
0	0
HARQ Process Number	Repetitions of DCI Subframe
0	0
Number of Resource Units (N_{RU})	Repetitions of NPDCCH (R)
1	1

DCI format N0 and transmits the following information.

"Subcarrier Identification Field of NPUSCH (I_{SC})"

6 bits

Define the starting frequency and resource unit of the NPUSCH allocation, see [Table 5-37](#).

Remote command:

`[:SOURCE<hw>] :BB:EUTRa:DL:NIOT:DCI:ALLoc<ch0>:SCIND`
on page 852

"Resource Assignment Field of NPUSCH (I_{RU})"

3 bits

The resulting number of resource units for NPUSCH N_{RU}^{NPUSCH} is indicated by the parameter [Number of Resource Units \(\$N_{RU}\$ \)](#).

I_{RU}	0	1	2	3	4	5	6	7
N_{RU}	1	2	3	4	5	6	8	10

See also ["Number of Resource Units \$N_{RU}\$ "](#) on page 416.

Remote command:

[\[:SOURCE<hw>\]:BB:EUTRa:DL:NIOT:DCI:ALLoc<ch0>:IRU](#)
on page 847

"Scheduling Delay Field (I_{Delay})"

2 bits

Determines the number of DL subframes with that the NPDSCH is delayed after the NPDCCH transmission.

Table 5-24: Number of subframes NPDSCH is delayed (k_0 for DCI format N0)

I_{Delay}	k_0
0	8
1	16
2	32
3	64

See also [Chapter 5.2.6, "NPDSCH"](#), on page 358.

Remote command:

[\[:SOURCE<hw>\]:BB:EUTRa:DL:NIOT:DCI:ALLoc<ch0>:IDELay](#)
on page 847

"Modulation and Coding Scheme (I_{MSC})"

4 bits

Define the modulation order Q_m and the transport block index I_{TBS} . The TBS is set automatically for $Q_m = 2$ according to [TS 36.213](#).

Remote command:

[\[:SOURCE<hw>\]:BB:EUTRa:DL:NIOT:DCI:ALLoc<ch0>:MCScheme](#)
on page 848

"Redundancy Version"

1 bit

Sets if the transmission start with RV0 or RV2.

Remote command:

[\[:SOURCE<hw>\]:BB:EUTRa:DL:NIOT:DCI:ALLoc<ch0>:RVERsion](#)
on page 852

"Number of NPUSCH Repetition Fields (I_{Rep})"

3 bits

Gives number of times NPUSCH is repeated N_{Rep}^{NPUSCH} .

Remote command:

```
[ :SOURCE<hw> ] :BB:EUTRa:DL:NIOT:DCI:ALLoc<ch0>:
NPUSch:IREP on page 850
```

"New Data Indicator"

1 bit

As in LTE.

Remote command:

```
[ :SOURCE<hw> ] :BB:EUTRa:DL:NIOT:DCI:ALLoc<ch0>:NDIND
on page 848
```

"Repetitions of DCI Subframes"

2 bits

Used to configure the NPDCCH mapping, see [Table 5-16](#).The resulting number of repetitions $N_{RepNPDCCH}$ (R) is indicated by the parameter [Repetitions of NPDCCH \(R\)](#).

Remote command:

```
[ :SOURCE<hw> ] :BB:EUTRa:DL:NIOT:DCI:ALLoc<ch0>:SFRPt
on page 852
```

"HARQ Process Number"

1 bit

Sets the HARQ process number, if "DL Frame Configuration > User" > [Support two HARQ Processes](#) = "On"

Remote command:

```
[ :SOURCE<hw> ] :BB:EUTRa:DL:NIOT:DCI:ALLoc<ch0>:
HPNMBer on page 851
```

DCI Format N1 ← DCI Content Configuration

The DCI format N1 is used for scheduling of one NPUSCH codeword in one cell and random access procedure initiated by an NPUSCH order.

EUTRA/LTE A: DCI Format Configuration (1)	
Bit Data	1000 0000 0000 0000 0000 0000
DCI Format N1	
NPDCCH Order Indicator <input type="checkbox"/>	Scheduling Delay Field (I_{Delay}) 0
Resource Assignment Field (I_{SF}) 0	Modulation and Coding Scheme (I_{MCS}) 0
Number of NPDSCH Repetitions Field (I_{Rep}) 0	New Data Indicator <input type="checkbox"/>
HARQ-ACK Resource Field 0	Repetitions of DCI Subframe 0
HARQ Process Number 0	
Distance from NPDCCH to NPDSCH Standard	
Transport Block Size 16	Number of NPDSCH Subframes (N_{SF}) 1
Repetitions of NPDSCH (N_{Rep}) 1	Repetitions of NPDCCH (R) 1

DCI format N1 is 23-bits long and transmits the following information.

"NPDCCH Order Indicator"

1 bit

- 0: indicates scheduling one NPDSCH codeword in one cell
- 1: indicates random access procedure initiated by an NPDCCH order

The remaining bits are set to 1.

Remote command:

[:SOURCE<hw>] :BB:EUTRa:DL:NIOT:DCI:ALLoc<ch0>: NPDCCh:OIND on page 848

"Starting Number of NPRACH Repetitions (I_{Rep})"

2 bits

Used if "NPDCCH Order Indicator = 1" and DCI format N1 CRC is scrambled with C-RNTI

Defines the number of NPRACH repetitions N_{Rep} following a PDCCH order.

I_{Rep}	0	1	2	3
$N_{\text{Rep}}^{\text{NPRACH}}$	R1	R2	R3	reserved

Where $R1 < R2 < R3$ and $N_{\text{Rep}} = \{1, 2, 4, 8, 16, 32, 64, 128\}$, see "Number of Repetitions" on page 425.

Remote command:

[:SOURCE<hw>] :BB:EUTRa:DL:NIOT:DCI:ALLoc<ch0>: NPRach:SNUMBER on page 850

"Subcarrier Indication Field of NPRACH (I_{SC})"

6 bits

Used if "NPDCCH Order Indicator = 1" and DCI format N1 CRC is scrambled with C-RNTI

Indicates the subcarrier allocated for NPRACH.

Remote command:

```
[ :SOURCE<hw> ] :BB:EUTRa:DL:NIOT:DCI:ALLoc<ch0>:
NPRach:SCINd on page 850
```

"Scheduling Delay Field (I_{Delay})"

2 bits

Determines the number of DL subframes with that the NPDSCH is delayed after the NPDCCH transmission. This delay is added to the minimum delay of 5 subframes.

Table 5-25: Number of subframes NPDSCH is delayed (k_0 for DCI format N1 depending on R_{max})

I_{Delay}	$R_{max} < 128$	$R_{max} > 128$
0	0	0
1	4	1
2	8	32
3	12	64
4	16	128
5	32	256
6	64	512
7	128	1024

See also [Chapter 5.2.6, "NPDSCH"](#), on page 358.

Remote command:

```
[ :SOURCE<hw> ] :BB:EUTRa:DL:NIOT:DCI:ALLoc<ch0>:
IDELay on page 847
```

"Resource Assignment Field (I_{SF})"

3 bits

Defines the number of subframes of NPDSCH (N_{SF}^{NPDSCH}). The resulting value is indicated by the parameter [Number of NPDSCH Subframes \(\$N_{SF}\$ \)](#).

Table 5-26: Number of subframes N_{SF}^{NPDSCH} for NPDSCH

I_{SF}	0	1	2	3	4	5	6	7
N_{SF}^{NPDSCH}	1	2	3	4	5	6	8	10

Remote command:

```
[ :SOURCE<hw> ] :BB:EUTRa:DL:NIOT:DCI:ALLoc<ch0>:
NPDSch:ISF on page 849
```

"Modulation and Coding Scheme (I_{MSC})"

4 bits

Define the modulation order Q_m and the transport block index I_{TBS} .The TBS is set automatically for $Q_m = 2$ according to [TS 36.213](#).

Remote command:

```
[ :SOURCE<hw> ] :BB:EUTRa:DL:NIOT:DCI:ALLoc<ch0> :
MCScheme on page 848
```

"Number of NPDSCH Repetition Fields (I_{Rep})"

4 bits

Defines the number of times NPDSCH is repeated N_{Rep}^{NPDSCH} . Theresulting value is indicated by the parameter [Repetitions of NPDSCH \(\$N_{Rep}\$ \)](#).**Table 5-27: Number of repetitions N_{Rep}^{NPDSCH} for NPDSCH**

I_{Rep}	0	1	2	3	4	5	6	7	8	9	10	11	12	13	14	15
N_{Rep}^{NPDSCH}	1	2	4	8	16	32	64	128	192	256	284	512	768	1024	1536	2048

Remote command:

```
[ :SOURCE<hw> ] :BB:EUTRa:DL:NIOT:DCI:ALLoc<ch0> :
NPDSch:IREP on page 849
```

"New Data Indicator"

1 bit; as in LTE.

Field is reserved, if DCI format N1 CRC is scrambled with RA-RNTI.

Remote command:

```
[ :SOURCE<hw> ] :BB:EUTRa:DL:NIOT:DCI:ALLoc<ch0> :NDIND
on page 848
```

"HARQ-ACK Resource Field"

4 bits

Field is reserved, if DCI format N1 CRC is scrambled with RA-RNTI.

Defines the subcarrier and the subframe number ($n+k_0-1$) used by the NPUSCH that carries the ACK/NACK acknowledgment of the NPDSCH reception.

Where:

- n is the end subframe of the NPDSCH
- k_0 is the delay selected depending on the "HARQ-ACK Resource Field" value and the UL subcarrier spacing

Remote command:

```
[ :SOURCE<hw> ] :BB:EUTRa:DL:NIOT:DCI:ALLoc<ch0> :HACK
on page 847
```

"Repetitions of DCI Subframes"

2 bits

Used to configure the NPDCCH mapping, see [Table 5-16](#).

The resulting number of repetitions $N_{RepNPDCCH}$ (R) is indicated by the parameter [Repetitions of NPDCCH \(R\)](#).

Remote command:

`[:SOURCE<hw>] :BB:EUTRa:DL:NIOT:DCI:ALLoc<ch0>:SFRPt`
on page 852

"HARQ Process Number"

1 bit

Can be set if at least 2 HARQ processes are configured.

Remote command:

`[:SOURCE<hw>] :BB:EUTRa:DL:NIOT:DCI:ALLoc<ch0>:HPNMBer`
on page 851

"Transport Block Size"

Indicates the TBS, calculated for the selected "Modulation and Coding Scheme (I_{MCS})" and "Resource Assignment Field (I_{SF})".

The TBS is set automatically for $Q_m = 2$ according to [TS 36.213](#).

Remote command:

`[:SOURCE<hw>] :BB:EUTRa:DL:NIOT:DCI:ALLoc<ch0>:TBSZ?`
on page 853

DCI Format N2 ← DCI Content Configuration

The DCI format N2 is used for paging and direct indication. It is available for "User = P-RNTI".

DCI Format N2	
Flag for Paging/Direct Indication	<input checked="" type="checkbox"/>
Resource Assignment Field (I_{SF})	0
Modulation and Coding Scheme (I_{MCS})	0
Number of NPDSCH Repetitions Field (I_{Rep})	0
Repetitions of DCI Subframe	0
Repetitions of NPDCCH (R)	1

DCI format N2 is 15-bits long and transmits the following information.

"Flag for Paging/Direct Indication"

1 bit

- 1: Paging
- 0: Direct indication

8 bits that provide direct indication of system information update and other fields;

Direct indication information is transmitted on NPDCCH using P-RNTI but without an associated paging message.

Bit (in LSB order)	Field in direct indication information
1	"System Info Modification"
2	"System Info Modification - Extended Discontinuous Reception"
3 to 8	not used

Remote command:

`[:SOURCE<hw>] :BB:EUTRa:DL:NIOT:DCI:ALLoc<ch0>:PAG`
on page 852

"System Info Modification - Extended Discontinuous Reception"

1 bit (systemInfoModification-eDRX)

Used if "Flag for Paging/Direct Indication = 1" and DCI format N2
CRC is scrambled with P-RNTI

Remote command:

`[:SOURCE<hw>] :BB:EUTRa:DL:NIOT:DCI:ALLoc<ch0>:SIME`
on page 853

"System Info Modification"

1 bit (systemInfoModification)

Used if "Flag for Paging/Direct Indication = 1" and DCI format N2
CRC is scrambled with P-RNTI

Remote command:

`[:SOURCE<hw>] :BB:EUTRa:DL:NIOT:DCI:ALLoc<ch0>:SINF`
on page 853

"Resource Assignment Field (I_{SF})"

3 bits

Defines the number of subframes of NPDSCH, see [Table 5-26](#).

Remote command:

`[:SOURCE<hw>] :BB:EUTRa:DL:NIOT:DCI:ALLoc<ch0>:
NPDSch:ISF` on page 849

"Modulation and Coding Scheme (I_{MSC})"

4 bits

Define the modulation order Q_m and the transport block index I_{TBS} .
The TBS is set automatically for $Q_m = 2$ according to [TS 36.213](#).

Remote command:

`[:SOURCE<hw>] :BB:EUTRa:DL:NIOT:DCI:ALLoc<ch0>:
MCScheme` on page 848

"Number of NPDSCH Repetition Fields (I_{Rep})"

4 bits

Defines the number of times NPDSCH is repeated N_{Rep} , see [Table 5-27](#).

Remote command:

```
[ :SOURCE<hw> ] :BB:EUTRa:DL:NIOT:DCI:ALLoc<ch0>:NPDSch:IREP on page 849
```

"Repetitions of DCI Subframes"

2 bits

Used to configure the NPDCCH mapping, see [Table 5-15](#).

The resulting number of repetitions $N_{RepNPDCCH}$ (R) is indicated by the parameter [Repetitions of NPDCCH \(R\)](#).

Remote command:

```
[ :SOURCE<hw> ] :BB:EUTRa:DL:NIOT:DCI:ALLoc<ch0>:SFRPt on page 852
```

Distance from NPDCCH to NPDSCH ← DCI Content Configuration

For "DCI Format = N1", sets how the distance between the NPDCCH to NPDSCH is determined.

- "Standard" NPDSCH starts at least five subframes after NPDCCH, i.e. there is a gap of 4 subframes between both channels.
- "Minimum" In subframes without synchronization signals, PBCH or SIB transmissions, NPDSCH starts in the first valid subframe right after the NPDCCH.
- "Zero" Disables the NPDSCH SIB1-NR and NPUCCH transmissions. The NPDSCH is transmitted immediately after the NPDCCH. Use this value to increase the number of NPDSCH allocations. To observe the allocated subframes, select "DL frame Configuration > NB-IoT > Allocation" > [Subframe List](#).

Remote command:

```
[ :SOURCE<hw> ] :BB:EUTRa:DL:NIOT:DCI:ALLoc<ch0>:DIST on page 854
```

Transport Block Size ← DCI Content Configuration

Indicates the TBS, calculated for the selected "Modulation and Coding Scheme (I_{MSC})" and "Resource Assignment Field (I_{SF})".

The TBS is set automatically for $Q_m = 2$ according to [TS 36.213](#).

Remote command:

```
[ :SOURCE<hw> ] :BB:EUTRa:DL:NIOT:DCI:ALLoc<ch0>:TBSZ? on page 853
```

Number of Resource Units (N_{RU}) ← DCI Content Configuration

Displays the resulting number of NPUSCH resource units N_{RU}^{NPUSCH} , retrieved from the selected "Resource Assignment Field of NPUSCH (I_{RU})".

Remote command:

```
[ :SOURCE<hw> ] :BB:EUTRa:DL:NIOT:DCI:ALLoc<ch0>:NRUnits? on page 851
```

Number of NPDSCH Subframes (N_{SF}) ← DCI Content Configuration

Displays the resulting number of NPDSCH subframes (N_{SF}), see [Table 5-26](#).

Remote command:

```
[ :SOURCE<hw> ] :BB:EUTRa:DL:NIOT:DCI:ALLoc<ch0>:NPDSch:NSF?
```

on page 850

Repetitions of NPDSCH (N_{Rep}) ← DCI Content Configuration

Displays the resulting number of NPDSCH repetitions (N_{Rep}), see [Table 5-27](#).

Remote command:

```
[ :SOURCE<hw> ] :BB:EUTRa:DL:NIOT:DCI:ALLoc<ch0>:NPDSch:NREP?
```

on page 849

Repetitions of NPDCCH (R) ← DCI Content Configuration

Displays the resulting number of NPDCCH repetitions (R), depending on:

- "Search Space" on page 382
- R_{max} , set per search space in the dialogs [Common Search Space](#) and [UE-Specific Search Space](#)
- "Repetitions of DCI Subframes" DCI field of corresponding DCI format.

See:

- [Table 5-15](#)
- [Table 5-16](#)

Remote command:

```
[ :SOURCE<hw> ] :BB:EUTRa:DL:NIOT:DCI:ALLoc<ch0>:NPDCch:REP?
```

on page 848

Start Subframe

Sets the next valid starting subframe for the particular NPDCCH, see ["Calculating the NPDCCH starting subframe"](#) on page 355.

Remote command:

```
[ :SOURCE<hw> ] :BB:EUTRa:DL:NIOT:DCI:ALLoc<ch0>:STSFrame on page 845
```

NPDCCH Format

Sets the NPDCCH format.

Table 5-28: NPDCCH formats

NPDCCH format	Number of NCCEs	Search space
0	1	UE-specific
1	2	UE-specific Type 1 common Type 2 common

Remote command:

```
[ :SOURCE<hw> ] :BB:EUTRa:DL:NIOT:DCI:ALLoc<ch0>:NPDCch:FMT
```

on page 845

Number NCCEs

NPDCCH is transmitted on an aggregation of one or two consecutive narrowband control channel elements (NCCE), see [Figure 5-14](#).

The value is calculated from the selected "NPDCCH Format" and "NCCE Index", see [Table 5-28](#).

Remote command:

[:SOURce<hw>] :BB:EUTRa:DL:NIOT:DCI:ALLoc<ch0>:CCES? on page 846

NCCE Index

For UE-specific search space, sets the NCCE start index.

NCCE index	Occupied subcarriers per subframe
0	0 to 5
1	6 to 11

See also [Figure 5-14](#).

Remote command:

[:SOURce<hw>] :BB:EUTRa:DL:NIOT:DCI:ALLoc<ch0>:IDCCe on page 846

Conflict

Indicates a conflict between two DCI formats, for example if they have the same NCCE index and start subframe.

Remote command:

[:SOURce<hw>] :BB:EUTRa:DL:NIOT:DCI:ALLoc<ch0>:CONFlict?

on page 846

5.3.2.3 NB-LoT allocations (NPBCH, NPDCCH, NPDSCH)

Access:

1. Select "General > Link Direction > Downlink".
2. Select "Frame Configuration > General > NB-LoT Allocation".
3. Select "p A" to boost the power of a particular allocation.

The dialog displays the NB-LoT allocations in the **anchor carrier**.

The screenshot shows the 'EUTRA/LTE: DL Frame Configuration' window with the 'eMTC' tab selected. A 'Resource Block Index' dropdown is set to '4'. Below it is a table with columns: Content Type, Modulation, Enh. Sett., Subframe List, Start Sym., Phys. Bits, Data Source, DList / Pattern, p A / dB, St., C., and Allocation. The table contains four rows of configuration data.

	Content Type	Modulation	Enh. Sett.	Subframe List	Start Sym.	Phys. Bits	Data Source	DList / Pattern	p A / dB	St.	C.	Allocation
0	NPBCH	QPSK	Conf.	0, 10, 20, 30...	3	200	MIB	-	0.00	On		
1	NPDSCH SIB1-NB	QPSK	Conf.	4, 24, 44, 64...	3	236	PN9	-	0.00	On		
2	NPDCCH	QPSK	Conf.	6, 7, 8, 11	3	236	User3	-	0.00	On		
3	NPDSCH	QPSK	Conf.	26, 27, 28, 31...	3	236	User3	-	0.00	On		

The NPBCH allocation and the SIB1-NB transmissions are configured automatically, but can be changed. See [Chapter 5.3.2.4, "NPBCH channel coding and MIB-NB configuration"](#), on page 398.

The NPDSCH and NPDCCH allocations are configured according to the current DCI configuration, see [Chapter 5.3.2.2, "NB-LoT DCI configuration"](#), on page 379.

Settings:

Resource Block Index..... 394

Allocation number..... 394

Content Type..... 394

Modulation..... 395

Enhanced Settings > Config..... 395

Suframe List..... 395

Start Symbol..... 395

Phys. Bits..... 396

Data Source..... 396

p A..... 397

State..... 397

Conflict..... 397

Resource Block Index

Indicates the resource block number of the anchor NB-LoT carrier.

The value is set with the parameter [RB Index](#).

Allocation number

Consecutive number of the allocation.

Remote command:

[:SOURce<hw>] :BB:EUTRa:DL:NIOT:NALLoc? on page 854

Content Type

Indicates the channel type.

Allocation number	Channel	Description
0	NPBCH	Narrowband broadcast channel
1	<ul style="list-style-type: none"> NPDSCH SIB1-NB NPDCCH NPDSCH 	<ul style="list-style-type: none"> If MIB (including SFN) > "On", one NPDSCH that carries the SIB1-NB message is automatically configured If MIB (including SFN) > "Off", NPDCCH is configured If Distance from NPDCCH to NPDSCH > "Zero", because NPDSCH SIB1-NB and NPDCCH are not transmitted
> 1	<ul style="list-style-type: none"> NPDCCH NPDCCH and NPDSCH 	Allocated automatically, depending on the current DCI configuration, Chapter 5.3.2.2, "NB-IoT DCI configuration" , on page 379: <ul style="list-style-type: none"> One narrowband DL control channel per active NB-IoT user, see "Configure User" > 3GPP Release One pair per paging and random access RNTI

Remote command:

[\[:SOURCE<hw>\]:BB:EUTRa:DL:NIOT:ALLoc<ch0>:CONType?](#) on page 855

Modulation

All DL NB-IoT channels are QPSK modulated.

Remote command:

[\[:SOURCE<hw>\]:BB:EUTRa:DL:NIOT:ALLoc<ch0>:MODulation?](#) on page 855

Enhanced Settings > Config

Accesses the precoding, scrambling and channel coding settings of the selected channel, see:

- [Chapter 5.3.2.4, "NPBCH channel coding and MIB-NB configuration"](#), on page 398
- [Chapter 5.3.2.5, "NPDSCH and NPDCCH channel coding and scrambling"](#), on page 402

Suframe List

Indicates the subframes in that the channel is allocated.

The subframes are calculated depending on the duplexing mode, the channel type, the number of repetitions and the valid subframes, see ["Valid Subframes"](#) on page 374.

Remote command:

[\[:SOURCE<hw>\]:BB:EUTRa:DL:NIOT:ALLoc<ch0>:SFList?](#) on page 855

Start Symbol

Indicates the first symbol (I_{Start}) in a subframe where NB-IoT channels can be allocated.

Table 5-29: Start symbol I_{Start}

Channel	Data	Start symbol $I_{NPDCCHStart}$	Mode
NPBCH	MIB	<ul style="list-style-type: none"> 3^{*)} 	<ul style="list-style-type: none"> Regardless
NPDCCH	any	<ul style="list-style-type: none"> 1, 2, 3 0 	<ul style="list-style-type: none"> "In-band" "Guard Band"/ "Standalone"
NPDSCH	<ul style="list-style-type: none"> SIB1-NB other 	<ul style="list-style-type: none"> 3^{*)} 1, 2, 3 0 	<ul style="list-style-type: none"> Regardless "In-band" "Guard Band"/ "Standalone"

*) To avoid collisions with control information in the LTE system, NPBCH and NPDSCH carrying SIB-NB are allocated after the LTE PDCCH control region.

Remote command:

[:SOURCE<hw>] :BB:EUTRa:DL:NIOT:ALLoc<ch0>:STSymbol on page 855

Phys. Bits

Displays the allocation size in bits (N_{PhysBits}).

For QPSK modulation, the allocated number of bits is calculated as follows:

Number of Physical Bits = 2*Number of RE per PRB or

$$N_{\text{PhysBits}} = 2 * N_{\text{RE}}$$

Where:

- N_{RE} are number of available resource elements RE per resource blocks PRB after the "Start Symbol" and excluding reference RE reserved for LTE CRS and NRS.
- For NPDSCH, N_{RE} is $N_{\text{RE}}^{\text{NPDSCH}}$ is selected from [Table 5-30](#).
- For NPDCCH format 0 with one NCCE, N_{RE} is $2 * N_{\text{RE}}^{\text{NPDCCH},0} = N_{\text{RE}}^{\text{NPDSCH}}$
- For NPDCCH format 1 with two NCCEs), N_{RE} is $N_{\text{RE}}^{\text{NPDCCH},1} = N_{\text{RE}}^{\text{NPDSCH}}$

Table 5-30: Number of available resource elements RE per resource blocks PRB (N_{RE}) after the Start Symbol $I_{\text{NDPCCStart}}$

Mode	Number of NB APs (NB-IoT MIMO Configuration)	Number of LTE APs ("Global MIMO Configuration")	$I_{\text{NDPCC}}^{\text{HStart} = 0}$	$I_{\text{NDPCC}}^{\text{HStart} = 1}$	$I_{\text{NDPCC}}^{\text{HStart} = 2}$	$I_{\text{NDPCC}}^{\text{HStart} = 3}$
Guard Band/ Standalone	1	0	160	-	-	-
	2	0	152	-	-	-
In-band	1	1	-	142	130	118
	1	2	-	136	124	112
	1	4	-	128	120	108
	2	1	-	134	122	110
	2	2	-	128	116	104
	2	4	-	120	112	100

NPBCH carries 200 bits per frame.

Remote command:

[:SOURCE<hw>] :BB:EUTRa:DL:NIOT:ALLoc<ch0>:PHYSbits? on page 856

Data Source

Indicates the data source depending on the "Content Type".

The data source can be changed in the following cases:

- For NPDSCH allocations that are configured for "NB-IoT DCI Config > User = P-RNTI or RA-RNTI"
- If "NPBCH > Enhanced Settings > Config > Channel Coding = Off"
- For the NPDSCH SIB1-NB allocation
Use this function to load data lists as source for the SIB messages.

The following standard data sources are available:

- "All 0, All 1"
An internally generated sequence containing 0 data or 1 data.
- "PNxx"
An internally generated pseudo-random noise sequence.
- "Pattern"
An internally generated sequence according to a bit pattern.
Use the "Pattern" box to define the bit pattern.
- "Data List/Select DList"
A binary data from a data list, internally or externally generated.
Select "Select DList" to access the standard "Select List" dialog.
 - Select the "Select Data List > navigate to the list file *.dm_iqd > Select" to select an existing data list.
 - Use the "New" and "Edit" functions to create internally new data list or to edit an existing one.
 - Use the standard "File Manager" function to transfer external data lists to the instrument.

See also:

- Section "Modulation Data" in the R&S SMM100A user manual.
- Section "File and Data Management" in the R&S SMM100A user manual.
- Section "Data List Editor" in the R&S SMM100A user manual

Remote command:

[\[:SOURce<hw>\]:BB:EUTRa:DL:NIOT:ALLoc<ch0>:DATA](#) on page 856

[\[:SOURce<hw>\]:BB:EUTRa:DL:NIOT:ALLoc<ch0>:DSElect](#) on page 857

[\[:SOURce<hw>\]:BB:EUTRa:DL:NIOT:ALLoc<ch0>:PATTern](#) on page 857

p A

Sets the power P_{NPBCH} , P_{NPDCCH} or P_{NPDSCH} (ρA) of the selected allocation.

Remote command:

[\[:SOURce<hw>\]:BB:EUTRa:DL:NIOT:ALLoc<ch0>:POWer](#) on page 856

State

Indicates that the allocation is active.

Remote command:

[\[:SOURce<hw>\]:BB:EUTRa:DL:NIOT:ALLoc<ch0>:STATe?](#) on page 857

Conflict

Indicates a conflict between allocations.

If conflict occurs, change used NCCE index and the change starting subframe.

Remote command:

[\[:SOURce<hw>\]:BB:EUTRa:DL:NIOT:ALLoc<ch0>:CONFlict?](#) on page 857

5.3.2.4 NPBCH channel coding and MIB-NB configuration

Access:

1. Select "General > Link Direction > Downlink".
2. Select "Frame Configuration > NB-LoT Allocation".
3. Select "NPBCH > Enhanced Settings > Config".

NPBCH can be generated in one of the following modes:

- Without channel coding, if "Channel Coding > State > Off"
Dummy data or user-defined data lists are used.
- Channel coding with arbitrary transport block content
If channel coding is activated ("Channel Coding > State > On") and parameter "MIB (including SFN) > Off"
- Channel coding with real data (MIB-NB) including SFN
If channel coding and "MIB (including SFN)" are activated
This mode is required for the generation of SIB1-NB message.

Settings:

Precoding settings.....	398
L Precoding Scheme.....	399
L Number of Layers.....	399
Scrambling settings.....	399
L NPBCH Symbol Rotation.....	399
Channel coding settings.....	399
L Channel Coding State.....	400
L Number of Physical Bits.....	400
L MIB (including SFN).....	400
L SFN Offset.....	400
L Scheduling SIB1.....	400
L NPDSCH repetition carrying SIB1.....	401
L NCell ID.....	401
L Starting Frame carrying SIB1.....	401
L MIB Spare Bits.....	402
L Transport Block Size/Payload (DL).....	402

Precoding settings

Access: select "Frame Configuration > NB-LoT Allocation > NPBCH > Enhanced Settings > Config > Precoding".

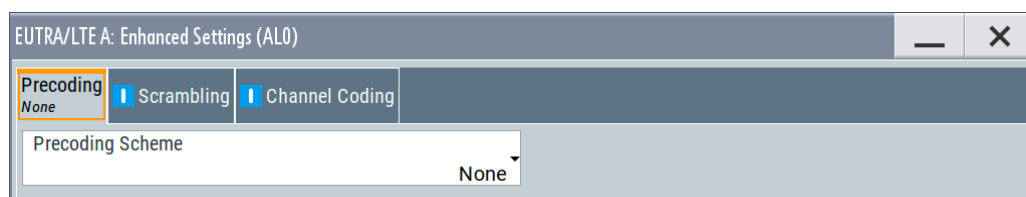

Precoding Scheme ← Precoding settings

Selects the precoding scheme.

"None" Disables precoding.

"Tx Diversity" If **NB-IoT MIMO Configuration** = "2 Tx Antennas", select precoding for transmit diversity.

Remote command:

`[:SOURCE<hw>] :BB:EUTRa:DL:NIOT:ALLoc<ch0>:PRECoding:SCHEME`
on page 858

Number of Layers ← Precoding settings

Displays the number of layers for the selected allocation.

Remote command:

`[:SOURCE<hw>] :BB:EUTRa:DL:NIOT:ALLoc<ch0>:PRECoding:NOLayers?`
on page 858

Scrambling settings

Access: select "Frame Configuration > NB-IoT Allocation > NPBCH > Enhanced Settings > Config > Scrambling".

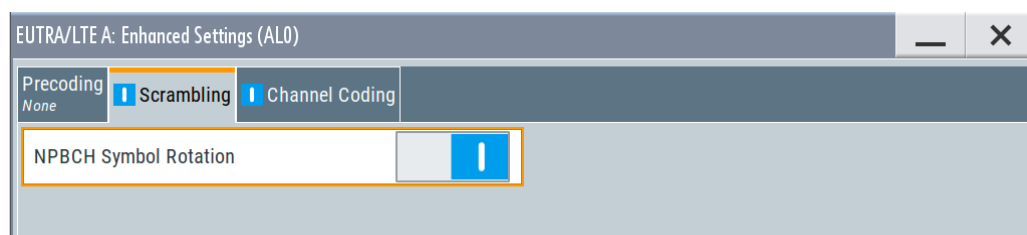
**NPBCH Symbol Rotation ← Scrambling settings**

Enables NPBCH scrambling with symbol rotation, as specified in LTE Rel. 13.

Remote command:

`[:SOURCE<hw>] :BB:EUTRa:DL:NIOT:ALLoc<ch0>:SCRambling:SROT`
on page 859

Channel coding settings

Access: select "Frame Configuration > NB-IoT Allocation > NPBCH > Enhanced Settings > Config > Channel Coding".

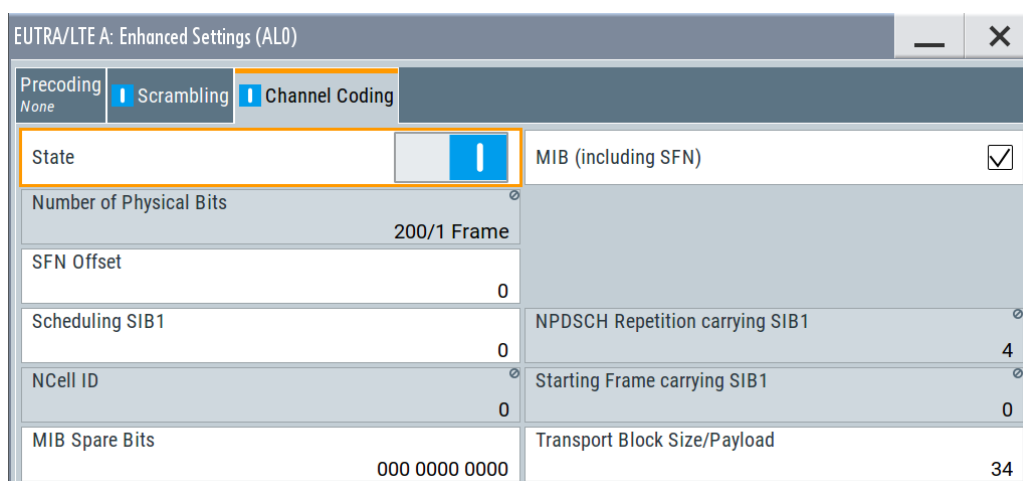

EUTRA/LTE A: Enhanced Settings (ALO)		
Precoding None	Scrambling	Channel Coding
State	<input checked="" type="checkbox"/>	MIB (including SFN) <input checked="" type="checkbox"/>
Number of Physical Bits	200/1 Frame	
SFN Offset	0	
Scheduling SIB1	0	NPDSCH Repetition carrying SIB1 4
NCell ID	0	Starting Frame carrying SIB1 0
MIB Spare Bits	000 0000 0000	Transport Block Size/Payload 34

Channel Coding State ← Channel coding settings

Enables channel coding.

Remote command:

```
[ :SOURCE<hw> ] :BB:EUTRa:DL:NIOT:ALLoc<ch0>:CCODing:STATE
```

on page 860

Number of Physical Bits ← Channel coding settings

Indicates the calculated number of physical bits; resembles the information displayed with parameter [Phys. Bits](#).

Remote command:

```
[ :SOURCE<hw> ] :BB:EUTRa:DL:NIOT:ALLoc<ch0>:PHYSbits? on page 856
```

MIB (including SFN) ← Channel coding settings

Enables transmission of real MIB (master information block) data. The SFN (system frame number) is included as well.

Remote command:

```
[ :SOURCE<hw> ] :BB:EUTRa:DL:NIOT:CCODing:MIB on page 861
```

SFN Offset ← Channel coding settings

By default, the counting of the SFN (system frame number) starts with 0. This parameter sets a different start SFN value.

Remote command:

```
[ :SOURCE<hw> ] :BB:EUTRa:DL:NIOT:CCODing:SOFFset on page 863
```

Scheduling SIB1 ← Channel coding settings

Sets the parameter `schedulingInfoSIB1` that defines the NPDSCH number of repetitions $N_{\text{Rep}}^{\text{NPDSCH}}$, see [NPDSCH repetition carrying SIB1](#).

Table 5-31: Number of repetitions N_{Rep}^{NPDSCH} for NPDSCH carrying SIB1-NB

schedulingInfoSIB1	0	1	2	3	4	5	6	7	8	9	10	11	12 to 15
"Duplexing = FDD" N_{Rep}^{NPDSCH}	4	8	16	4	8	16	4	8	16	4	8	16	reserved
Option: R&S SMM-146 "Duplexing = TDD" N_{Rep}^{NPDSCH}	4	8	16	4	8	16	4	8	16	4	8	16	16

Remote command:

`[:SOURCE<hw>] :BB:EUTRa:DL:NIOT:CCODing:SIB` on page 862

NPDSCH repetition carrying SIB1 ← Channel coding settings

Indicates the number of NPDSCH repetitions, if this NPDSCH carries SIB1-NB (see Table 5-31).

Remote command:

`[:SOURCE<hw>] :BB:EUTRa:DL:NIOT:CCODing:RSIB?` on page 862

NCell ID ← Channel coding settings

Indicates the NCell ID N_{ID}^{Cell} , as selected with the parameter NCell ID.

Remote command:

`[:SOURCE<hw>] :BB:EUTRa:DL:NIOT:CCODing:NCID?` on page 862

Starting Frame carrying SIB1 ← Channel coding settings

Indicates the first frame in that the NPDSCH transmission carrying SIB1-NB is allocated.

The value is calculated for the selected NPDSCH repetition carrying SIB1 and NCell ID.

N_{Rep}^{NPDSCH}	N_{ID}^{Cell}	Starting frame for SIB1-NB repetitions
4	$N_{ID}^{Cell} \bmod 4 = 0$	0
4	$N_{ID}^{Cell} \bmod 4 = 1$	16
4	$N_{ID}^{Cell} \bmod 4 = 2$	32
4	$N_{ID}^{Cell} \bmod 4 = 3$	48
8	$N_{ID}^{Cell} \bmod 2 = 0$	0
8	$N_{ID}^{Cell} \bmod 2 = 1$	16
16	$N_{ID}^{Cell} \bmod 2 = 0$	0
16	$N_{ID}^{Cell} \bmod 2 = 1$	1

Remote command:

`[:SOURCE<hw>] :BB:EUTRa:DL:NIOT:CCODing:STFSib1?` on page 863

MIB Spare Bits ← Channel coding settings

Sets the 11 spare bits in the NPBCH transmission.

Remote command:

[\[:SOURCE<hw>\]:BB:EUTRa:DL:NIOT:CCODing:MSPare](#) on page 862

Transport Block Size/Payload (DL) ← Channel coding settings

Displays the size of the transport block/payload in bits.

For NPBCH, the transport block size is always 34 bits.

Remote command:

[\[:SOURCE<hw>\]:BB:EUTRa:DL:NIOT:ALLoc<ch0>:CCODing:TBSize?](#)
on page 861

5.3.2.5 NPDSCH and NPDCCH channel coding and scrambling

Access:

1. Select "General > Link Direction > Downlink".
2. Select "Frame Configuration > NB-LoT Allocation".
3. Select "NPDSCH/NPDCCH > Enhanced Settings > Config".
Access settings of "Precoding", "Scrambling" and "Channel Coding".

Settings:

Precoding settings.....	402
L Precoding Scheme.....	403
L Number of Layers.....	403
Scrambling settings.....	403
L Scrambling State.....	403
L UE ID/n _{RNTI}	403
L Legacy Scrambling.....	404
Channel coding settings.....	404
L Channel Coding State.....	404
L Number of Physical Bits.....	405
L Number of NPDSCH Subframes (N _{SF}).....	405
L Resource Assignment Field (I _{SF}).....	405
L Transport Block Size Index (I _{TBS}).....	405
L Transport Block Size/Payload (DL).....	405

Precoding settings

Access: select "Frame Configuration > NB-LoT Allocation > NPDSCH > Enhanced Settings > Config > Precoding".

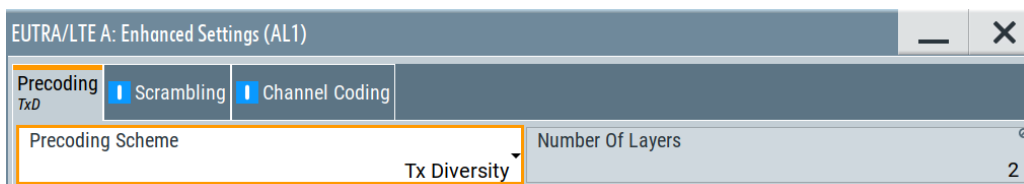
**Precoding Scheme** ← Precoding settings

Selects the precoding scheme.

"None" Disables precoding.

"Tx Diversity"

If **NB-LoT MIMO Configuration** = "2 Tx Antennas", select precoding for transmit diversity.

Remote command:

`[:SOURCE<hw>] :BB:EUTRa:DL:NIOT:ALLoc<ch0>:PRECoding:SCHEME`
on page 858

Number of Layers ← Precoding settings

Displays the number of layers for the selected allocation.

Remote command:

`[:SOURCE<hw>] :BB:EUTRa:DL:NIOT:ALLoc<ch0>:PRECoding:NOLayers?`
on page 858

Scrambling settings

Access: select "Frame Configuration > NB-LoT Allocation > NPDSCH > Enhanced Settings > Config > Scrambling".

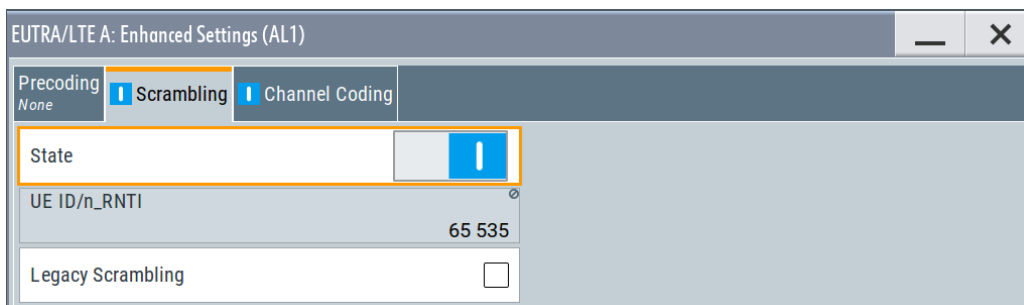
**Scrambling State** ← Scrambling settings

Enables scrambling.

Remote command:

`[:SOURCE<hw>] :BB:EUTRa:DL:NIOT:ALLoc<ch0>:SCRambling:STATE`
on page 859

UE ID/n_RNTI ← Scrambling settings

Indicates the user equipment identifier (n_RNTI) or UE ID of the user to which the NPDSCH transmission is intended. The displayed "UE ID/n_RNTI" value is used to calculate the scrambling sequence.

Remote command:

`[:SOURCE<hw>] :BB:EUTRa:DL:NIOT:ALLoc<ch0>:SCRambling:UEID?`

on page 859

Legacy Scrambling ← Scrambling settings

Option: R&S SMM-K143

If disabled, scrambling according to LTE Rel. 14 is applied.

Remote command:

`[:SOURCE<hw>] :BB:EUTRa:DL:NIOT:ALLoc<ch0>:SCRambling:LEGacy:`

`STATE` on page 860

Channel coding settings

Access: select "Frame Configuration > NB-IoT Allocation > NPDSCH > Enhanced Settings > Config > Channel Coding".

EUTRA/LTE A: Enhanced Settings (AL1)	
Precoding <i>None</i>	Scrambling
State	<input checked="" type="checkbox"/>
Number of Physical Bits	-
Number of NPDSCH Subframes (N_{SF})	1
Resource Assignment Field (I_{SF})	0
Transport Block Size Index (I_{TBS})	0
Transport Block Size/Payload	208

Channel Coding State ← Channel coding settings

Enables channel coding.

Remote command:

`[:SOURCE<hw>] :BB:EUTRa:DL:NIOT:ALLoc<ch0>:CCODing:STATE`

on page 860

Number of Physical Bits ← Channel coding settings

Indicates the calculated number of physical bits; resembles the information displayed with parameter [Phys. Bits](#).

Remote command:

`[:SOURCE<hw>] :BB:EUTRa:DL:NIOT:ALLoc<ch0>:PHYSbits?` on page 856

Number of NPDSCH Subframes (N_{SF}) ← Channel coding settings

Indicates the value calculated from the current DCI configuration.

See:

- ["NPDSCH scheduling"](#) on page 359
- E.g. ["DCI Format N1"](#) on page 385

Remote command:

`[:SOURCE<hw>] :BB:EUTRa:DL:NIOT:ALLoc<ch0>:CCODing:NSF?` on page 861

Resource Assignment Field (I_{SF}) ← Channel coding settings

Indicates the value calculated from the current DCI configuration.

See:

- ["NPDSCH scheduling"](#) on page 359
- E.g. ["DCI Format N1"](#) on page 385

Remote command:

`[:SOURCE<hw>] :BB:EUTRa:DL:NIOT:ALLoc<ch0>:CCODing:ISF?` on page 860

Transport Block Size Index (I_{TBS}) ← Channel coding settings

Sets the transport block size index.

Remote command:

`[:SOURCE<hw>] :BB:EUTRa:DL:NIOT:ALLoc<ch0>:CCODing:TBSI` on page 861

Transport Block Size/Payload (DL) ← Channel coding settings

Displays the size of the transport block/payload in bits for the current [Transport Block Size Index \(\$I_{TBS}\$ \)](#).

Remote command:

`[:SOURCE<hw>] :BB:EUTRa:DL:NIOT:ALLoc<ch0>:CCODing:TBSize?`

on page 861

5.3.3 FRC settings

Access:

1. Select "General > UL Frame Configuration > UE x > 3GPP Release = NB-IoT".
2. Select "UE x > FRC".

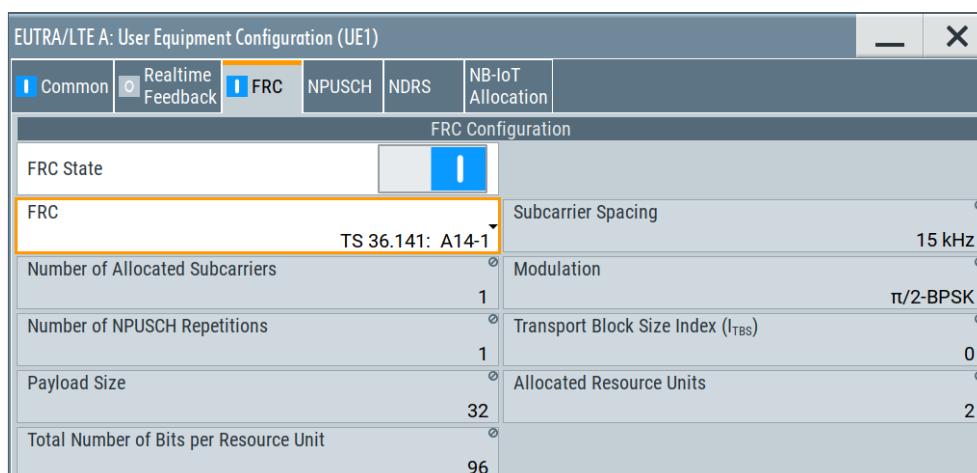

This dialog provides a quick configuration of the predefined fixed reference channels (FRC) according to:

- TS 36.141, Annex A "Reference measurement channels"
- TS 36.521, Annex A "Measurement channels".

If "FRC" is enabled, several parameters are predefined and their values are displayed as read-only values.

Settings:

FRC State..... 406

FRC.....406

Subcarriers Spacing.....407

Number of Allocated Subcarriers..... 407

Modulation.....407

Number of NPUSCH Repetitions..... 407

Transport Block Size Index I_{TBS}407

Payload Size..... 407

Allocated Resource Units.....408

Total Number of Bits per Resource Unit.....408

FRC State

Enables FRC configuration.

If "FRC" is enabled, several parameters are predefined and their values are displayed as read-only values. To reconfigure any of these parameters, disable the FRC configuration.

Remote command:

```
[ :SOURce<hw> ] :BB:EUTRa:UL:UE<st>:NIOT:FRC:STATE on page 912
```

FRC

Selects a predefined fixed reference channel according to TS 36.141 or to TS 36.521.

3GPP specifies the FRCs for a specific channel bandwidth (i.e. number of resource blocks). Depending on the current configuration, some FRCs are not listed.

Table 5-32: Supported FRCs from 3GPP TS 36.141

FRC	Description
A14-1 to A14-4	FRC for NB-IOT reference sensitivity ($\pi/2$ BPSK, R=1/3)
A15-1 to A15-2	FRC for NB-LoT dynamic range ($\pi/4$ QPSK, R=2/3)
A16-1 to A16-5	FRC for NB-LoT NPUSCH format 1

Table 5-33: Supported FRCs from 3GPP TS 36.521-1

FRC (Duplexing = FDD)	FRC (Duplexing = TDD)	Description
A.2.4-1 to A.2.4-7	-	Reference channels for category NB1

Remote command:

`[:SOURCE<hw>] :BB:EUTRa:UL:UE<st>:NIOT:FRC:TYPE` on page 912

Subcarriers Spacing

Displays the subcarrier spacing.

Remote command:

`[:SOURCE<hw>] :BB:EUTRa:UL:UE<st>:NIOT:FRC:SCSPacing?` on page 914

Number of Allocated Subcarriers

Displays the number of the allocated subcarriers.

Remote command:

`[:SOURCE<hw>] :BB:EUTRa:UL:UE<st>:NIOT:FRC:NOSCarriers?` on page 913

Modulation

Displays the modulation for the selected FRC.

Remote command:

`[:SOURCE<hw>] :BB:EUTRa:UL:UE<st>:NIOT:FRC:MODulation?` on page 913

Number of NPUSCH Repetitions

Displays the number of NPUSCH repetitions.

Remote command:

`[:SOURCE<hw>] :BB:EUTRa:UL:UE<st>:NIOT:FRC:NNPRep` on page 913

Transport Block Size Index I_{TBS}

Displays the transport block size index I_{TBS} .

Remote command:

`[:SOURCE<hw>] :BB:EUTRa:UL:UE<st>:NIOT:FRC:TBSSindex?` on page 914

Payload Size

Displays the payload size for the selected FRC.

Remote command:

`[:SOURCE<hw>] :BB:EUTRa:UL:UE<st>:NIOT:FRC:PASize?` on page 913

Allocated Resource Units

Displays the total number of physical bits available for the NPUSCH allocation per resource unit.

Remote command:

`[:SOURCE<hw>] :BB:EUTRa:UL:UE<st>:NIOT:FRC:ALResunits?` on page 912

Total Number of Bits per Resource Unit

Displays the total number of physical bits available for the NPUSCH allocation per resource unit.

Remote command:

`[:SOURCE<hw>] :BB:EUTRa:UL:UE<st>:NIOT:FRC:BPresunit?` on page 912

5.3.4 NDMRS settings

Access:

1. Select "General > General UL Settings > Signals".

The NDMRS settings are grouped in the "NB-IoT DMRS" section.

Physical 10 MHz	Cell	Signals	PRACH	PUSCH	PUCCH	
Group Hopping		<input type="checkbox"/>	Use Base Sequences		<input type="checkbox"/>	Common
Delta Sequence Shift for NPUSCH		0	Three Tone Base Sequence		0	SRS
Three Tone Cyclic Shift		0	Six Tone Base Sequence		0	NB-IoT DMRS
Six Tone Cyclic Shift		0	Twelve Tone Base Sequence		0	

2. To configure the NDMRS setting per UE, select "EUTRA/LTE > Frame Configuration > General > UE1".
3. Select "User Equipment Configuration > NDMRS".

You can boost the NDMRS signal compared to the NPUSCH allocation and disable the NPUSCH group hopping for a particular UE.

EUTRA/LTE A: User Equipment Configuration (UE1)

Common	Realtime Feedback	FRC	NPUSCH	NDMRS	NB-IoT Allocation
DMRS					
DMRS Power Offset		0.000 dB		Disable Group Hopping <input type="checkbox"/> Disabled	

The NDMRS allocation, both as slot assignment and duration, depends on the NPUSCH allocation of the particular UE. In particular, it depends on the NPUSCH format per allocation and the subcarrier spacing.

- To configure the NPUSCH allocation, select "User Equipment Configuration > NB-IoT Allocation".

- To observe the NDMRS allocation, including duration and slot assignment, select "EUTRA/LTE > Frame Configuration > Time Plan". Select "View Mode = Single RB" and select the resource block index used in the "NB-IoT Allocation" dialog. For example, see [Example "NPUSCH configuration"](#) on page 362.

NDMRS settings:

NB-IoT DMRS general settings.....	409
L Group Hopping.....	409
L Delta Sequence Shift for NPUSCH.....	409
L Three/Six-Tone Cyclic Shift.....	409
L Use Base Sequences.....	409
L Three/Six/Twelve-Tone Base Sequence.....	410
UE-specific NDMRS settings.....	410
L Disable Group Hopping.....	410

NB-IoT DMRS general settings

The following are the NDRM settings, common to all UEs. They are related to NDMRS generation and hopping.

Group Hopping ← NB-IoT DMRS general settings

Enables group hopping (`groupHoppingEnabled`) for the uplink demodulation reference signal (DMRS).

Remote command:

`[:SOURCE<hw>] :BB:EUTRa:UL:REFSig:DRS:GHOPping` on page 895

Delta Sequence Shift for NPUSCH ← NB-IoT DMRS general settings

Sets the delta sequence shift α for NPUSCH required for the calculation of the group hopping pattern.

Remote command:

`[:SOURCE<hw>] :BB:EUTRa:UL:REFSig:DRS:DSEQshift` on page 896

Three/Six-Tone Cyclic Shift ← NB-IoT DMRS general settings

Sets the higher layer parameters `threeTone-CyclicShift` and `sixTone-CyclicShift`.

In combination with the base sequence, these parameters define the sequence with which the demodulation reference signal (NDMRS) is transmitted.

Remote command:

`[:SOURCE<hw>] :BB:EUTRa:UL:REFSig:DRS:TTCShift` on page 896

`[:SOURCE<hw>] :BB:EUTRa:UL:REFSig:DRS:STCShift` on page 896

Use Base Sequences ← NB-IoT DMRS general settings

Enables using base sequences for the generation of the NB-IoT DMRS sequence hopping pattern.

Remote command:

`[:SOURCE<hw>] :BB:EUTRa:UL:REFSig:DRS:USEBase` on page 896

Three/Six/Twelve-Tone Base Sequence ← NB-IoT DMRS general settings

Sets the higher layer parameters `threeTone-BaseSequence`, `sixTone-BaseSequence`, and `twelveTone-BaseSequence`. They define the base sequence with which the demodulation reference signal (NDMRS) is transmitted.

Each of the three sequences is used in case the signal is modulated onto three, six or 12 carriers.

Remote command:

`[:SOURCE<hw>] :BB:EUTRa:UL:REFSig:DRS:TTBSequence` on page 897

`[:SOURCE<hw>] :BB:EUTRa:UL:REFSig:DRS:STBSequence` on page 897

`[:SOURCE<hw>] :BB:EUTRa:UL:REFSig:DRS:TWBSequence` on page 897

UE-specific NDMRS settings

With the provided settings, you can boost the NDMRS signal compared to the NPUSCH allocation or disable the NPUSCH group hopping for the particular UE.

Disable Group Hopping ← UE-specific NDMRS settings

NDMRS group hopping is not applied for the selected UE.

This parameter works like sending the higher-level parameter `groupHoppingDisabled`.

Remote command:

`[:SOURCE<hw>] :BB:EUTRa:UL:UE<st>:NIOT:GHDisable` on page 903

5.3.5 NPUSCH settings

Access:

1. Select "General > UL Frame Configuration > UE x > 3GPP Release = NB-IoT".
2. Select "UE x > NPUSCH".

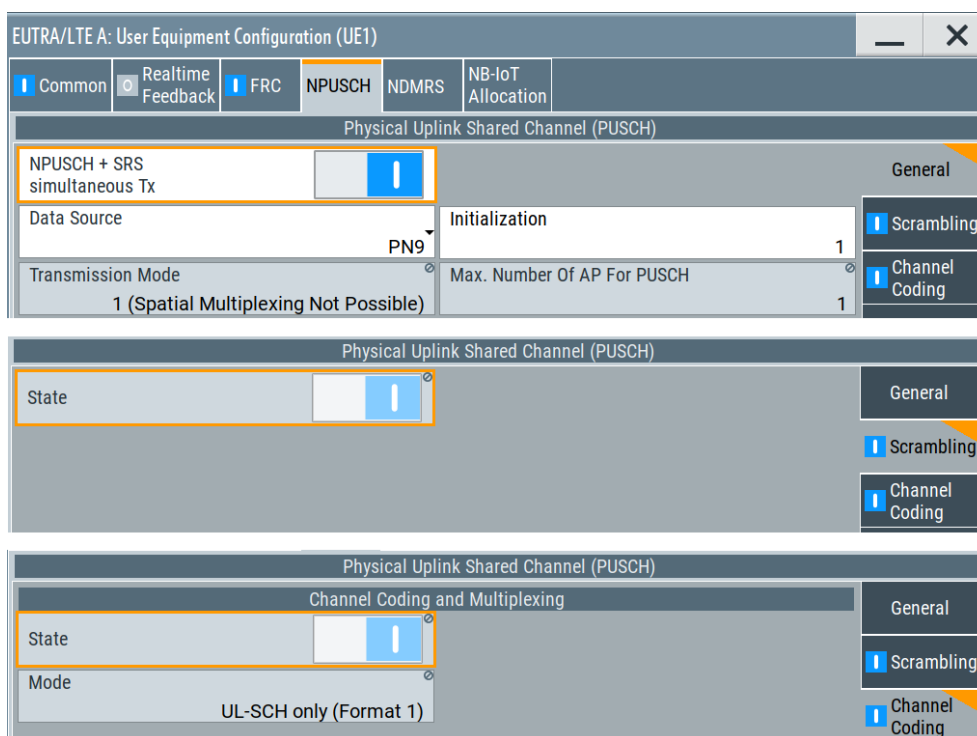

The provided settings are the same as for LTE, except that NB-LoT does not support MIMO. Hence, the "Transmission Mode = TM 1" and "Max. Number of AP for PUSCH = 1". You can enable NPUSCH scrambling and channel coding and multiplexing, where the multiplexing mode is selected automatically, depending on the NPUSCH format. (See "NPUSCH formats" on page 361).

3. To configure the **NPUSCH transmission per UE**, select "Frame Configuration > UE x > NB-LoT Allocation"

Other than in LTE, in NB-LoT the NB-LoT allocations (NPUSCH and NDMRS) are configured per UE.

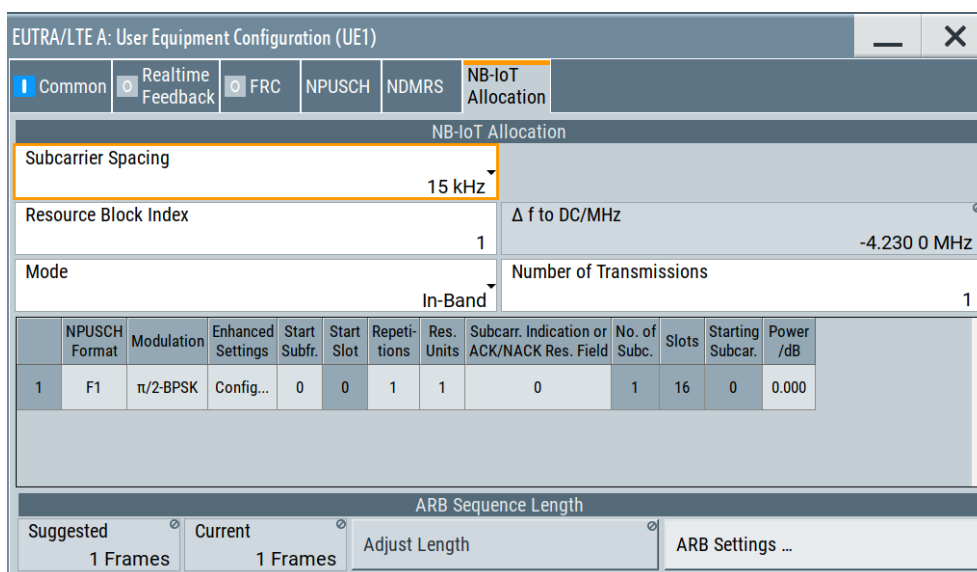

The NB-IoT allocation is individual per UE, in terms of subcarrier spacing, operating mode and used resource block. There can be up to 10 NPUSCH transmissions per UE, each of them using different NPUSCH format and occupying different resources in the time and in the frequency domain.

- In the "NB-IoT Allocation" table, select "Transmission # > Enhanced Settings > Config" to configure the channel coding and multiplexing of an NB-IoT allocation. See [Chapter 5.3.5.2, "NPUSCH enhanced settings"](#), on page 418.
- To observe the NPUSCH allocations, select "EUTRA/LTE > Frame Configuration > Time Plan".

To zoom in and display a particular resource block, select "View Mode = Single RB".

Select the resource block index used in the "NB-IoT Allocation" dialog.

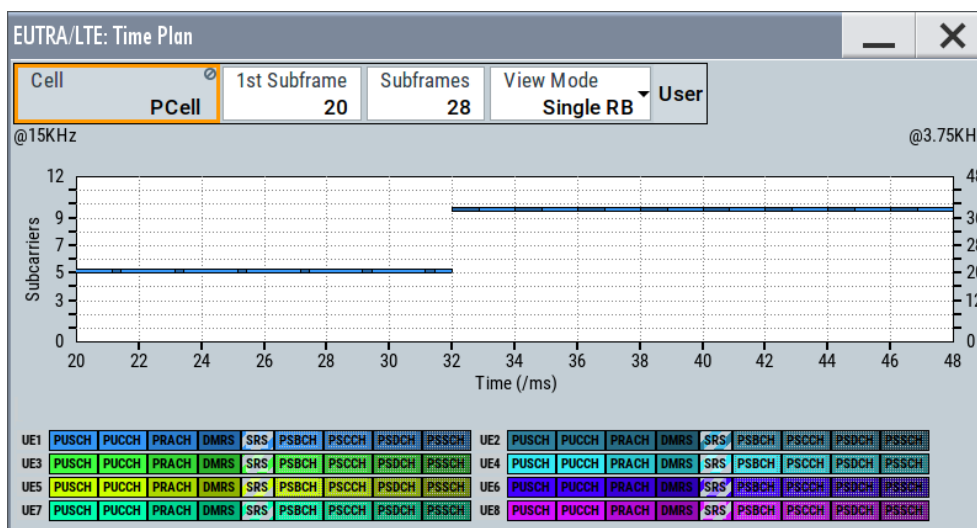

Settings:

- [NB-LoT allocation settings](#)..... 413
- [NPUSCH enhanced settings](#)..... 418

5.3.5.1 NB-LoT allocation settings

Access: see [Chapter 5.3.5, "NPUSCH settings"](#), on page 410.

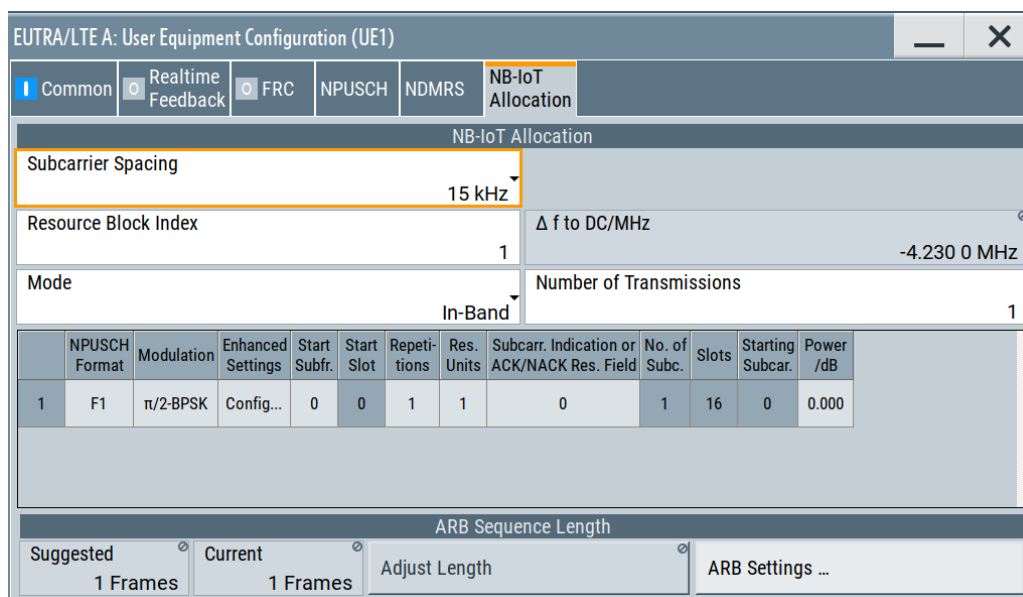

Settings:

- [Subcarrier Spacing](#)..... 414
- [Resource Block Index](#)..... 414
- [Delta Frequency to DC, MHz](#)..... 414
- [Mode](#)..... 415
- [Number of Transmissions](#)..... 415
- [NPUSCH Format](#)..... 415
- [Modulation](#)..... 415
- [Enhanced Setting > Config](#)..... 415
- [Starting Subframe \(SF\)](#)..... 415
- [Starting Slot](#)..... 416
- [Repetitions](#)..... 416
- [Number of Resource Units \$N_{RU}\$](#) 416
- [Subcarrier Indication or ACK/NACK Resource Field](#)..... 416
- [Number of Subcarriers](#)..... 417
- [Slots](#)..... 417
- [Starting Subcarrier](#)..... 417
- [Power, dB](#)..... 418
- [ARB Sequence Length](#)..... 418
 - ↳ [Suggested](#)..... 418

- L [Current](#).....418
- L [Adjust Length](#).....418
- L [ARB Settings](#).....418

Subcarrier Spacing

Sets the subcarrier spacing Δf per UE.

See also [Table 5-14](#).

Remote command:

`[:SOURCE<hw>] :BB:EUTRa:UL:UE<st>:NIOT:SCSPacing` on page 903

Resource Block Index

Sets the resource block number in that the NB-LoT transmissions are allocated.

The available resource blocks depend on the used "Channel Bandwidth" (or "Number of Available Resource Blocks") and the operating "Mode".

Table 5-34: Resource block index value ranges

Operation mode	Resource block allocation	Value range
In-band	Within the "Channel Bandwidth"	0 to "Number of Available Resource Blocks"
Guard band	Left guard band	< 0
	Right guard band	> "Number of Available Resource Blocks"

Remote command:

`[:SOURCE<hw>] :BB:EUTRa:UL:UE<st>:NIOT:RBIndex` on page 903

Delta Frequency to DC, MHz

In "Mode > In-band/Guardband", indicates the delta frequency with that the NB-LoT carrier is offset from the LTE center frequency.

The value depends on "Resource Block Index" and in in-band mode and per default in the guardband mode it is calculated as follows:

$$\text{"Delta Frequency"} = \Delta f_{\text{NB-LoT}} * (\text{"RB Index"} * N_{\text{SC}}^{\text{RB}} - \text{floor}(N_{\text{RB}}^{\text{UL}} * N_{\text{SC}}^{\text{RB}} / 2) + N_{\text{SC}}^{\text{RB}} / 2)$$

Where:

- $\Delta f_{\text{NB-LoT}}$ = "Subcarrier Spacing" = 15 kHz or 3.75 kHz is the NB-LoT subcarrier spacing
- $N_{\text{RB}}^{\text{UL}}$ is the "Number of Resource Blocks per Slot"
- $N_{\text{SC}}^{\text{RB}}$ = 12 is the number of subcarriers per RB

Thus, the possible values for the center frequencies of the NB-LoT channels are at 180 kHz offset to each other. In guard band mode, the you can change this spacing and set different "Delta Frequency to DC". If the set value does not correspond to a valid RB index, than the "RB Index = User".

According to the specification, the center frequencies of the NB-LoT channels in guard band mode must satisfy the following conditions:

- The first allocated NB-LoT RB must be orthogonal to the LTE RBs, whereas the following NB-LoT can be at 180 kHz or 15 kHz offset.
- The center frequencies of the NB-LoT carriers must satisfy the EARFCN conditions and hence be an integer multiple of 100 kHz; a raster of ± 2.5 kHz and ± 7.5 kHz is allowed, too.

Remote command:

[:SOURce<hw>] :BB:EUTRa:UL:UE<st>:NIOT:DFReq on page 904

Mode

Selects the operating mode, see [Figure 5-10](#).

Remote command:

[:SOURce<hw>] :BB:EUTRa:UL:UE<st>:NIOT:MODE on page 904

Number of Transmissions

Enables up to 20 individual NPUSCH transmissions, where each transmission is configured in a separate row in the NPUSCH allocation table.

Remote command:

[:SOURce<hw>] :BB:EUTRa:UL:UE<st>:NIOT:NTRansmiss on page 904

NPUSCH Format

Sets the NPUSCH transmission format.

See "[NPUSCH formats](#)" on page 361.

Remote command:

[:SOURce<hw>] :BB:EUTRa:UL:UE<st>:NIOT:TRANS<ch>:FORMat on page 904

Modulation

Selects the modulation scheme for the NPUSCH transmission.

The available modulation schemes depend on the NPUSCH format, see [Table 5-19](#).

Remote command:

[:SOURce<hw>] :BB:EUTRa:UL:UE<st>:NIOT:TRANS<ch>:MODulation
on page 905

Enhanced Setting > Config

Access dialogs with further channel coding and multiplexing settings.

The displayed settings depend on the selected NPUSCH format, see [Chapter 5.3.5.2, "NPUSCH enhanced settings"](#), on page 418

Starting Subframe (SF)

Sets the first subframe in that the NPUSCH transmission occurs and defines the NPUSCH position in the time domain.

Per default, each subsequent NPUSCH transmission of the same UE is allocated in the first possible SF following the end of the previous transmission. The following applies:

$$\text{StartSF}_{\text{NPUSCH},i+1} = \text{StartSF}_{\text{NPUSCH},i} + (N_{\text{Rep}}^{\text{NPUSCH},i} * N_{\text{RU}}^{\text{NPUSCH},i} * N_{\text{slot}}^{\text{RU}}) + 1$$

Use the "Time Plan" to observe the NPUSCH allocation.

Remote command:

[:SOURce<hw>] :BB:EUTRa:UL:UE<st>:NIOT:TRANS<ch>:STSFrame
on page 905

Starting Slot

Indicates the starting slot of the first subframe in that the NPUSCH transmission occurs.

Remote command:

`[:SOURCE<hw>] :BB:EUTRa:UL:UE<st>:NIOT:TRANS<ch>:STSLot?`
on page 907

Repetitions

Sets how many times an NPUSCH transmission is repeated ($N_{\text{Rep}}^{\text{NPUSCH}}$).

$N_{\text{Rep}}^{\text{NPUSCH}} = \{1, 2, 4, 8, 16, 32, 64, 128\}$

The value is set automatically, if an **FRC** is used.

Remote command:

`[:SOURCE<hw>] :BB:EUTRa:UL:UE<st>:NIOT:TRANS<ch>:REPetitions`
on page 905

Number of Resource Units N_{RU}

Sets the number of allocated resource units ($N_{\text{RU}}^{\text{NPUSCH}}$):

- For "NPUSCH Format = F1", $N_{\text{RU}}^{\text{NPUSCH}} = \{1, 2, 3, 4, 5, 6, 8, 10\}$
- For "NPUSCH Format = F2", $N_{\text{RU}}^{\text{NPUSCH}} = 1$

Remote command:

`[:SOURCE<hw>] :BB:EUTRa:UL:UE<st>:NIOT:TRANS<ch>:NRUNits`
on page 905

Subcarrier Indication or ACK/NACK Resource Field

Sets the parameter that defines the NPUSCH position in the frequency domain, see [Table 5-35](#).

Table 5-35: Parameters (without FRC) as function of NPUSCH format and subcarrier spacing

NPUSCH format	Parameter	$\Delta f = 3.75$ kHz	$\Delta f = 15$ kHz
F1	Subcarrier indication field I_{SC}	0 to 47	0 to 18
F2	ACK/NACK resource field	0 to 15	0 to 15

If a fixed reference channel (FRC) for NB-LoT is enabled, the values of subcarrier indication field depend on the selected FRC as follows. (See also [Chapter 5.3.3, "FRC settings"](#), on page 405).

Table 5-36: Subcarrier indication field I_{SC} values for FPC

FRC	A14-1	A14-2	A14-3	A14-4	A15-1	A15-2
I_{SC}	0 to 11	0 to 47	0 to 11	0 to 47	0 to 11	0 to 47

FRC	A16-1	A16-2	A16-3	A16-4	A16-5	A2.4-1
I_{SC}	0 to 47	0 to 11	12 to 15	16 to 17	18	0 to 47

FRC	A2.4-2	A2.4-3	A2.4-4	A2.4-5	A2.4-6	A2.4-7
I_{sc}	0 to 47	0 to 11	0 to 11	12 to 15	16 to 17	18

Remote command:

[:SOURCE<hw>] :BB:EUTRa:UL:UE<st>:NIOT:TRANS<ch>:SIRF on page 906

Number of Subcarriers

Display the allocated number of subcarriers (N_{sc}^{RU}).

- For "NPUSCH Format = F2" and for "NPUSCH Format = F1" with $\Delta f = 3.75$ kHz, $n_{sc} = 1$
- For "NPUSCH Format = F1" with $\Delta f = 15$ kHz, n_{sc} is calculated from the [Subcarrier Indication Field](#) I_{sc} .
See [Table 5-37](#)

Table 5-37: Number of subcarriers (N_{sc}^{RU}) [TS 36.211]

Subcarrier indication field I_{sc}	Set of allocated subcarriers n_{sc}
0 to 11	I_{sc}
12	{0, 1, 2}
13	{3, 4, 5}
14	{6, 7, 8}
15	{9, 10, 11}
16	{0, 1, 2, 3, 4, 5}
17	{6, 7, 8, 9, 10, 11}
18	{0, 1, 2, 3, 4, 5, 6, 7, 8, 9, 10, 11}
19 to 63	reserved

Remote command:

[:SOURCE<hw>] :BB:EUTRa:UL:UE<st>:NIOT:TRANS<ch>:NSCarriers?
on page 906

Slots

Indicates the allocated number of slots per RU N_{slot}^{RU} .

See [Table 5-19](#).

Remote command:

[:SOURCE<hw>] :BB:EUTRa:UL:UE<st>:NIOT:TRANS<ch>:NSLTs? on page 906

Starting Subcarrier

Indicates the subcarrier number of the first subcarrier in the NPUSCH transmission.

The value is calculated automatically for the allocated "Number of Subcarriers" and according to [Table 5-37](#).

Remote command:

[:SOURce<hw>] :BB:EUTRa:UL:UE<st>:NIOT:TRANs<ch>:STSCarrier?
on page 907

Power, dB

Sets the power of the NPUSCH transmission P_{NPUSCH} relative to the UE power.

Remote command:

[:SOURce<hw>] :BB:EUTRa:UL:UE<st>:NIOT:TRANs<ch>:POWer on page 907

ARB Sequence Length

Comprises setting for automatic adjustment of the ARB sequence length.

Suggested ← ARB Sequence Length

- NB-LoT allocations:
Indicates the ARB sequence length that is required for the selected NPUSCH transmissions.
- eMTC allocations:
Number of frames required for the one complete transmission.
The value is calculated as the sum of the Start_SF and n_{abs_SF} .

Use the "Adjust Length" function to apply the suggested value.

Remote command:

[:SOURce<hw>] :BB:EUTRa:UL:UE<st>:NIOT:ARB:SUGGested? on page 907
[:SOURce<hw>] :BB:EUTRa:UL:UE<st>:EMTC:ARB:SUGGested? on page 924

Current ← ARB Sequence Length

Indicates the current ARB sequence length.

Adjust Length ← ARB Sequence Length

Sets the ARB sequence length to the suggested value.

ARB Settings ← ARB Sequence Length

Opens the ARB dialog.

5.3.5.2 NPUSCH enhanced settings

Common.....	419
UL-SCH.....	419
L Total Number of Physical Bits.....	419
L Resource Unit Field Index I_{RU}	419
L Number of Resource Units N_{RU}	420
L Starting Redundancy Version Index (rv_ix).....	420
L Early Data Transmission (EDT) Support.....	420
L EDT-TBS.....	420
L Transport Block Size Index I_{TBS}	420
L Transport Block Size/Payload.....	421
Channel Coding / Multiplexing.....	421
L Number of A/N Bits.....	421

- L [ACK/NACK Pattern](#).....421
- L [Number of Coded A/N Bits](#).....421
- L [Scheduling Request \(SR\) Support](#).....421

Common

The "Common" settings dialog indicates the type of the selected channel and allows you to set the NPUSCH format, see "[NPUSCH Format](#)" on page 415.

UL-SCH

For "NPUSCH Format = F1", the "UL-SCH" dialog comprises settings concerning the transport block size.

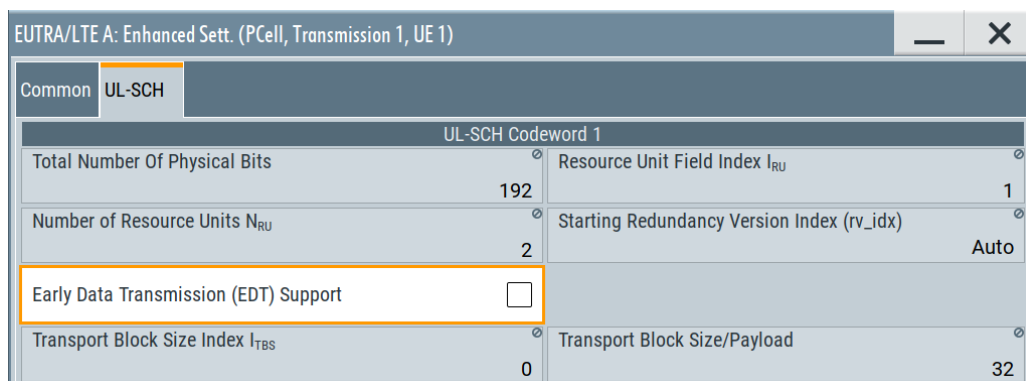

Total Number of Physical Bits ← UL-SCH

Indicates the number of physical bits of the selected NPUSCH transmission.

The value is calculated as described in "[Physical dimension of the NPUSCH allocation](#)" on page 362.

Remote command:

`[:SOURce<hw>] :BB:EUTRa:UL:UE<st>:NIOT:TRANs<ch>:PUSCh:PHYSbits?`
on page 910

Resource Unit Field Index I_{RU} ← UL-SCH

Indicates the resource unit (RU) field index I_{RU} selected depending on the used [Number of RU N_{RU}^{NPUSCH}](#), see [Table 5-38](#).

Table 5-38: RU field index [TS 36.213]

I _{RU}	N _{RU} ^{NPUSCH}
0	1
1	2
2	3
3	4
4	5
5	6
6	8
7	10

Remote command:

[:SOURCE<hw>] :BB:EUTRa:UL:UE<st>:NIOT:TRANS<ch>:PUSCh:RUIndex?
on page 910

Number of Resource Units $N_{RU} \leftarrow$ UL-SCH

Sets the number of allocated resource units (N_{RU}^{NPUSCH}):

- For "NPUSCH Format = F1", $N_{RU}^{NPUSCH} = \{1, 2, 3, 4, 5, 6, 8, 10\}$
- For "NPUSCH Format = F2", $N_{RU}^{NPUSCH} = 1$

Remote command:

[:SOURCE<hw>] :BB:EUTRa:UL:UE<st>:NIOT:TRANS<ch>:NRUnits
on page 905

Starting Redundancy Version Index (rv_ix) \leftarrow UL-SCH

Sets the starting redundancy version index.

Remote command:

[:SOURCE<hw>] :BB:EUTRa:UL:UE<st>:NIOT:TRANS<ch>:PUSCh:RVIndex
on page 911

Early Data Transmission (EDT) Support \leftarrow UL-SCH

Enables or disables early data transmission.

Early Data Transmission (EDT) Support	<input checked="" type="checkbox"/>
EDT-TBS	88

Remote command:

[:SOURCE<hw>] :BB:EUTRa:UL:UE<st>:NIOT:TRANS<ch>:PUSCh:ESUPport
on page 909

EDT-TBS \leftarrow Early Data Transmission (EDT) Support \leftarrow UL-SCH

Sets the transport block size for early data transmission in UL.

Remote command:

[:SOURCE<hw>] :BB:EUTRa:UL:UE<st>:NIOT:TRANS<ch>:PUSCh:ETBS
on page 909

[:SOURCE<hw>] :BB:EUTRa:UL:UE<st>:NIOT:TRANS<ch>:PUSCh:ETRSIZE
on page 910

Transport Block Size Index $I_{TBS} \leftarrow$ UL-SCH

Sets the transport block size index I_{TBS} .

The value is used to retrieve the [Transport Block Size/Payload](#).

Remote command:

[:SOURCE<hw>] :BB:EUTRa:UL:UE<st>:NIOT:TRANS<ch>:PUSCh:TBIndex
on page 911

Transport Block Size/Payload ← UL-SCH

Indicates the transport block size.

The value is retrieved from the selected I_{RU} ([Resource Unit Field Index \$I_{RU}\$](#)) and I_{TBS} ([Transport Block Size Index \$I_{TBS}\$](#)), as defined in TS 36.211.

Remote command:

`[:SOURCE<hw>] :BB:EUTRa:UL:UE<st>:NIOT:TRANs<ch>:PUSCh:TBSize?`
on page 911

Channel Coding / Multiplexing

For "NPUSCH Format = F2", the "Channel Coding / Multiplexing" dialog displays the predefined ACK/NACK configuration.

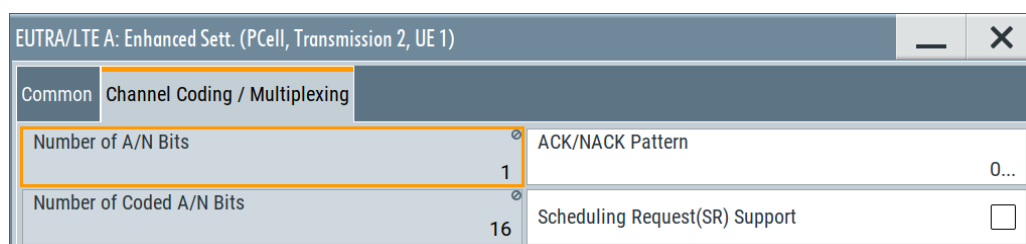
**Number of A/N Bits ← Channel Coding / Multiplexing**

NPUSCH format F2 uses 1 ACK/NACK bit.

Remote command:

`[:SOURCE<hw>] :BB:EUTRa:UL:UE<st>:NIOT:TRANs<ch>:HARQ:BITS?`
on page 908

ACK/NACK Pattern ← Channel Coding / Multiplexing

Set the ACK/NACK pattern as a sequence of 0 and 1.

Remote command:

`[:SOURCE<hw>] :BB:EUTRa:UL:UE<st>:NIOT:TRANs<ch>:HARQ:PATtern`
on page 909

Number of Coded A/N Bits ← Channel Coding / Multiplexing

For NPUSCH format F2, the number of coded bits is 16.

Remote command:

`[:SOURCE<hw>] :BB:EUTRa:UL:UE<st>:NIOT:TRANs<ch>:HARQ:CBITS?`
on page 908

Scheduling Request (SR) Support ← Channel Coding / Multiplexing

Option: R&S SMM-K146

If enabled, the SR symbols are multiplied with the C_{SR} sequence. The multiplication is performed block-wise and according to TS 36.211.

Enabled "Scheduling Request (SR) Support" corresponds transmission of the `sr-WithHRAQ-ACK-Config` field in the `ScheduligRequenst Config-NB` information element, according to TS 36.213.

Remote command:

[:SOURCE<hw>] :BB:EUTRa:UL:UE<st>:NIOT:TRANS<ch>:HARQ:SR
on page 909

5.3.6 NPRACH settings

Access:

1. In the "General" dialog, select "Mode > eMTC/NB-IoT".
2. Select "Link Direction > Uplink (SC-FDMA)".
3. Select "General > General UL Settings > PRACH > NB-IoT".

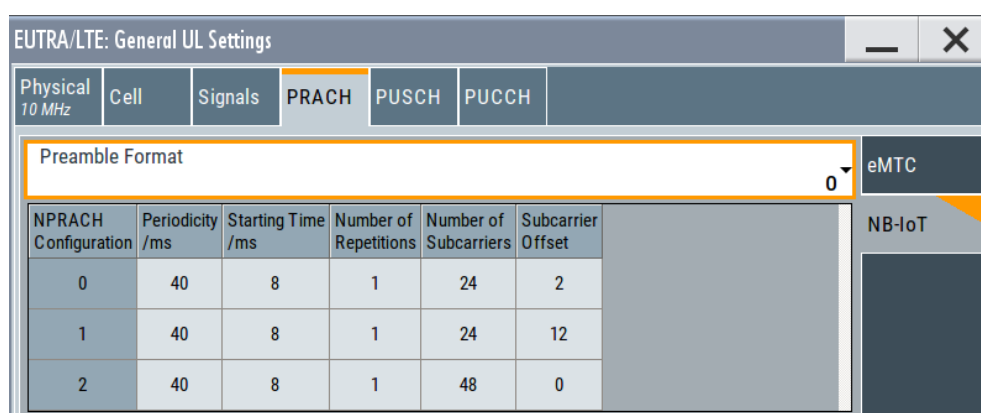

With the provided settings, you can configure three NPRACH configurations for the different coverage levels.

For description of the related settings, see ["NB-IoT NPRACH configurations"](#) on page 424.

4. To allocate the NPRACH for a specific UE, use the following parameters:
 - a) Select "UL Frame Configuration > UE1 > 3GPP Release = NB-IoT".
 - b) Select "UE1 > Settings > Common > Mode = PRACH".
 - c) Select "NPRACH".

EUTRA/LTE: User Equipment Configuration (UE1)

Common | **NPRACH**

Mode: In-Band

Resource Block Index: 24 Δ f to DC/MHz: -0.090 0 MHz

Number of Preamble Attempts: 1

NPRACH Configuration	Starting Subframe	Number of Repetitions	n _{init}	n _{start}	Power /dB
0	8	1	13	14	0.000

ARB Sequence Length

Suggested: 2 Current: 1 Frames Adjust Length ARB Settings ...

You can change the number of preamble attempts, select one of the three NPRACH configurations and set the parameter n_{init} to define the start of the first symbol group.

For description of the related settings, see "[NB-LoT NPRACH allocation per UE](#)" on page 425.

5. If necessary, use the "Adjust Length" function to enable larger number of frames automatically so that the NPRACH frequency hopping pattern is completed.
6. Open the "Time Plan" to visualize the NPRACH allocation:
 - a) Select "UL Frame Configuration > Time Plan".
 - b) Select "View Mode > Single RB".
 - c) Select the resource block index as configured in the "NPRACH" dialog. For example, select "RB = 24".
 - d) Configure the subframes to be displayed, for example "1st Subframe = 0" and "Subframes = 20".

The "Time Plan" shows the NPRACH.

For example, see [Figure 5-20](#).

NPRACH settings:

NB-LoT NPRACH configurations.....	424
L Preamble Format.....	424
L NPRACH configuration.....	424
L Periodicity, ms.....	424
L Starting Time, ms.....	424
L Number of Repetitions.....	425
L Number of Subcarriers.....	425
L Subcarrier Offset.....	425
NB-LoT NPRACH allocation per UE.....	425
L Mode.....	425
L Resource Block Index.....	425
L Delta Frequency to DC, MHz.....	426

L Number of Preamble Attempts.....	426
L NPRACH Configuration.....	426
L Starting Subframe.....	426
L Number of Repetitions.....	427
L n_{int}	427
L n_{start}	427
L Power.....	427
ARB Sequece Length > Sugested.....	427

NB-LoT NPRACH configurations

Use the provided settings to configure three NPRACH configurations for the different coverage levels (CE).

See also:

- "NPRACH configuration" on page 364
- Example "NPRACH configuration" on page 365

The following parameters are specified in TS 36.211 as part of the SIB2-NB message:

Preamble Format ← NB-LoT NPRACH configurations

Select the preamble format.

The preamble formats use different cyclic prefix length, which results in different symbol group lengths.

Option: R&S SMM-K146

- To enable format 2, select "Duplexing = FDD"
- To enable formats 0-A and 1-A, select "Duplexing = TDD" and "TDD UL/DL Configuration = 1 to 5".

To observe the influence of this parameter, use the "Time Plan".

See also [Figure 5-20](#).

Remote command:

[:SOURce<hw>] :BB:EUTRa:UL:PRACH:NIOT:PFMT on page 897

NPRACH configuration ← NB-LoT NPRACH configurations

Displays the NPRACH configuration number.

There are three NPRACH configurations, one per CE level. Each configuration is described with its time and frequency allocation and periodicity of occupancy.

Periodicity, ms ← NB-LoT NPRACH configurations

Sets the parameter $N_{periodicity}^{NPRACH}$ (mprach-periodicity).

It defines how often the NPRACH is scheduled. Available are periodicities between 40 ms and 2.56 s

Remote command:

[:SOURce<hw>] :BB:EUTRa:UL:PRACH:NIOT:CFG<ch0>:PERD on page 898

Starting Time, ms ← NB-LoT NPRACH configurations

Define the start time of the specific NPRACH configuration (nprach-StartTime).

See [Figure 5-20](#).

Remote command:

[:SOURce<hw>] :BB:EUTRa:UL:PRACH:NIOT:CFG<ch0>:STTM on page 898

Number of Repetitions ← NB-LoT NPRACH configurations

Indicates the number of NPRACH repetitions per preamble attempt $N_{\text{rep}}^{\text{NPRACH}}$ (maxNumPreambleAttemptCE-r13).

Remote command:

[:SOURce<hw>] :BB:EUTRa:UL:PRACH:NIOT:CFG<ch0>:REP on page 898

Number of Subcarriers ← NB-LoT NPRACH configurations

Sets the number of NPRACH subcarriers $N_{\text{sc}}^{\text{NPRACH}}$ (nprach-NumSubcarrierres).

See [Figure 5-20](#).

Remote command:

[:SOURce<hw>] :BB:EUTRa:UL:PRACH:NIOT:CFG<ch0>:SUBC on page 898

Subcarrier Offset ← NB-LoT NPRACH configurations

Sets the parameter $N_{\text{scoffset}}^{\text{NPRACH}}$ (nprach-SubcarrierOffset) and defines the frequency location of the first NPRACH subcarrier.

See [Figure 5-20](#).

Remote command:

[:SOURce<hw>] :BB:EUTRa:UL:PRACH:NIOT:CFG<ch0>:SCOF on page 899

NB-LoT NPRACH allocation per UE

Use this setting to can change the NPRACH allocation per UE, for example:

- The number of preamble attempts
- To select one of the three NPRACH configurations
- To set the parameter n_{int} to define the start of the first symbol group.

See also:

- ["NPRACH configuration"](#) on page 364
- [Example"NPRACH configuration"](#) on page 365

Mode ← NB-LoT NPRACH allocation per UE

Selects the operating mode, see [Figure 5-10](#).

Remote command:

[:SOURce<hw>] :BB:EUTRa:UL:UE<st>:PRACH:NIOT:MOD on page 914

Resource Block Index ← NB-LoT NPRACH allocation per UE

Defines the resource block in that the NPRACH is allocated.

The number of resource blocks depends on the selected "Channel Bandwidth" and is indicated with the parameter "UL General Settings > Physical > Number of Resource Blocks per Slot".

Remote command:

[:SOURce<hw>] :BB:EUTRa:UL:UE<st>:PRACH:NIOT:RBID on page 915

Delta Frequency to DC, MHz ← NB-LoT NPRACH allocation per UE

In "Mode > In-band/Guardband", indicates the delta frequency with that the NB-LoT carrier is offset from the LTE center frequency.

The value depends on "Resource Block Index" and in in-band mode and per default in the guardband mode it is calculated as follows:

$$\text{"Delta Frequency"} = \Delta f_{\text{NB-LoT}} * (\text{"RB Index"} * N_{\text{SC}}^{\text{RB}} - \text{floor}(N_{\text{RB}}^{\text{UL}} * N_{\text{SC}}^{\text{RB}} / 2) + N_{\text{SC}}^{\text{RB}} / 2)$$

Where:

- $\Delta f_{\text{NB-LoT}}$ = "Subcarrier Spacing" = 15 kHz or 3.75 kHz is the NB-LoT subcarrier spacing
- $N_{\text{RB}}^{\text{UL}}$ is the "Number of Resource Blocks per Slot"
- $N_{\text{SC}}^{\text{RB}} = 12$ is the number of subcarriers per RB

Thus, the possible values for the center frequencies of the NB-LoT channels are at 180 kHz offset to each other. In guard band mode, the you can change this spacing and set different "Delta Frequency to DC". If the set value does not correspond to a valid RB index, than the "RB Index = User".

According to the specification, the center frequencies of the NB-LoT channels in guard band mode must satisfy the following conditions:

- The first allocated NB-LoT RB must be orthogonal to the LTE RBs, whereas the following NB-LoT can be at 180 kHz or 15 kHz offset.
- The center frequencies of the NB-LoT carriers must satisfy the EARFCN conditions and hence be an integer multiple of 100 kHz; a raster of ± 2.5 kHz and ± 7.5 kHz is allowed, too.

Remote command:

`[:SOURCE<hw>] :BB:EUTRa:UL:UE<st>:PRACH:NIOT:DFReq` on page 915

Number of Preamble Attempts ← NB-LoT NPRACH allocation per UE

Sets the parameter $N_{\text{rep}}^{\text{NPRACH}}$ (`maxNumPreambleAttemptCE-r13`) to define how many times a preamble is repeated.

Each attempt can use different NPRACH configuration and different NPRACH time and frequency allocation.

Remote command:

`[:SOURCE<hw>] :BB:EUTRa:UL:UE<st>:PRACH:NIOT:PRATtempts` on page 914

NPRACH Configuration ← NB-LoT NPRACH allocation per UE

For each preamble attempt, selects one of the NPRACH configurations configured in the [NB-LoT NPRACH configurations](#) dialog.

Any subsequent preamble attempt must use an equal or bigger NPRACH configuration number as the previous one.

Remote command:

`[:SOURCE<hw>] :BB:EUTRa:UL:UE<st>:PRACH:ATT<ch0>:NIOT:CONFig`
on page 915

Starting Subframe ← NB-LoT NPRACH allocation per UE

For each preamble attempt, select the subframe (SF) number the first NPRACH symbol group appears for the first time.

See [Figure 5-20](#).

The available subframes depend on the selected [NPRACH Configuration](#) in the current and the previous preamble attempts.

Remote command:

```
[ :SOURCE<hw> ] :BB:EUTRa:UL:UE<st>:PRACH:ATT<ch0>:NIOT:SFStart
on page 915
```

Number of Repetitions ← **NB-IoT NPRACH allocation per UE**

Indicates the number of NPRACH repetitions per preamble attempt N_{rep}^{NPRACH} (`maxNumPreambleAttemptCE-r13`).

Remote command:

```
[ :SOURCE<hw> ] :BB:EUTRa:UL:PRACH:NIOT:CFG<ch0>:REP on page 898
```

n_{int} ← **NB-IoT NPRACH allocation per UE**

For each preamble attempt, sets the subcarrier index n_{int} , see ["NPRACH allocation"](#) on page 364.

The available subcarriers depend on the number of subcarriers in the selected "NPRACH Configuration", see ["Number of Subcarriers"](#) on page 425.

Remote command:

```
[ :SOURCE<hw> ] :BB:EUTRa:UL:UE<st>:PRACH:ATT<ch0>:NIOT:INIT
on page 916
```

n_{start} ← **NB-IoT NPRACH allocation per UE**

Indicates the value n_{start} , calculated as function of the selected n_{int} .

To observe the influence of this parameter, use the "Time Plan".

See [Figure 5-20](#).

See ["NPRACH allocation"](#) on page 364 for details on the calculation and information on all related parameters.

Remote command:

```
[ :SOURCE<hw> ] :BB:EUTRa:UL:UE<st>:PRACH:ATT<ch0>:NIOT:STRT?
on page 916
```

Power ← **NB-IoT NPRACH allocation per UE**

Sets the preamble attempt power relative to the UE power.

Remote command:

```
[ :SOURCE<hw> ] :BB:EUTRa:UL:UE<st>:PRACH:ATT<ch0>:NIOT:POWer
on page 916
```

ARB Sequence Length > Suggested

Indicates the ARB sequence length that is required for the NPRACH configuration.

Use the "Adjust Length" function to apply the suggested value.

Remote command:

```
[ :SOURCE<hw> ] :BB:EUTRa:UL:UE<st>:PRACH:NIOT:ARB:SUGGested?
on page 916
```

5.3.7 eMTC DL allocations settings

5.3.7.1 eMTC DL valid subframes and frequency hopping

Access:

1. Select "General > Link Direction > Downlink".
2. Select "General > Duplexing > FDD".
3. Select "General DL Settings > eMTC > Bitmap".

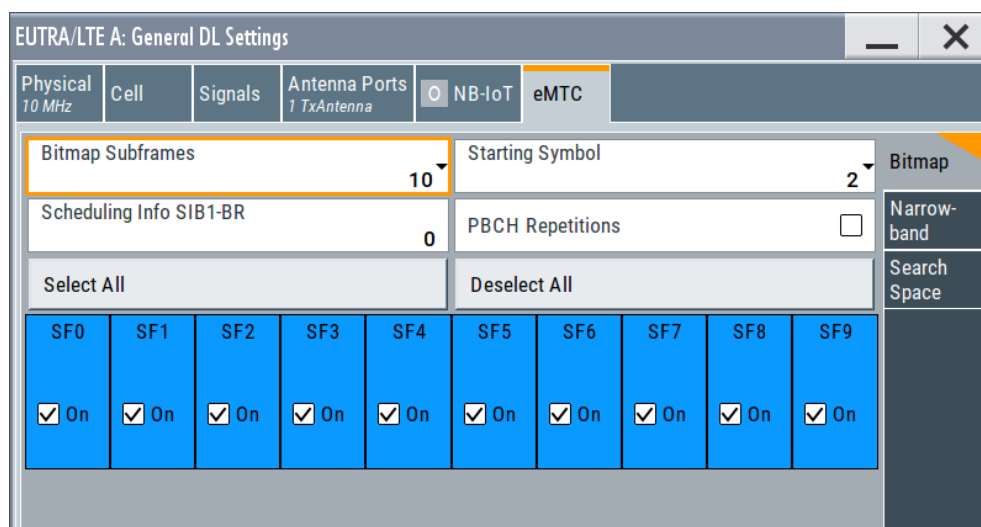

4. To configure subframe allocation for eMTC transmission, select:
 - a) "Bitmap Subframes = e.g. 10"
 - b) A subframe (SF) to enable it for eMTC transmission.
 eMTC transmission is postponed during invalid subframes.
5. To define the cell-specific frequency-hopping patterns of PDSCH and MPDCCH, select "eMTC > Narrowbands".

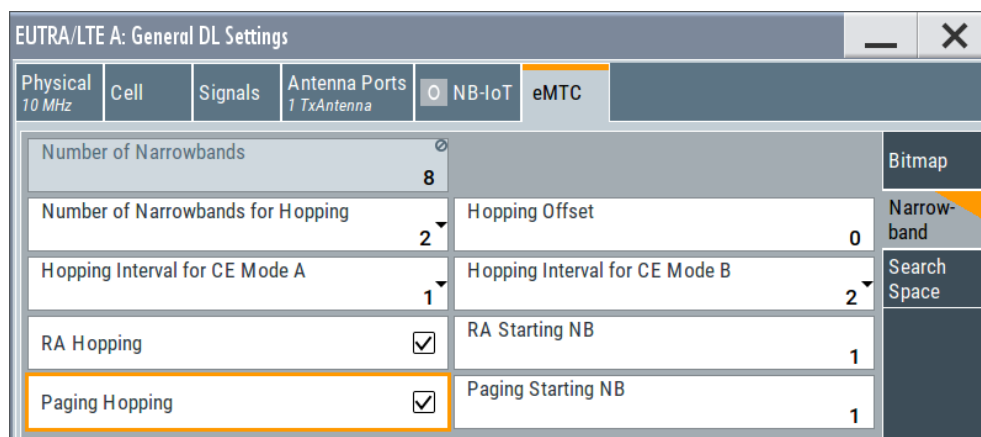

For description of the common search space settings, see [Chapter 5.3.7.2, "Search space settings"](#), on page 431.

Settings:

Bitmap.....	429
L Bitmap Subframes.....	429
L Starting Symbol.....	429
L Scheduling Info SIB1-BR.....	429
L PBCH Repetition.....	430
L Select All/Deselect All.....	430
L SF State.....	430
Narrowbands.....	430
L Number of eMTC Narrowbands.....	430
L Number of Narrowbands for Hopping.....	430
L Hopping Offset.....	430
L Hopping Interval for CE Mode A/B.....	431
L RA Hopping.....	431
L RA Starting NB.....	431
L Paging Hopping.....	431
L Paging Starting NB.....	431

Bitmap

Comprises general eMTC configuration settings. These settings include defining the valid subframes (SF) that can be used for eMTC transmission, reserving several symbols for the LTE control region, enabling PBCH repetition.

Bitmap Subframes ← Bitmap

Sets the valid subframes configuration over 10ms or 40ms (subframePattern10-r13, subframePattern40-r13).

The selected subframes influence the scheduling of the eMTC transmissions.

Remote command:

[:SOURce<hw>] :BB:EUTRa:DL:EMTC:BMP:SUBFrames on page 838

Starting Symbol ← Bitmap

Defines the first symbol within a frame that can be used for eMTC. The parameter is used to protect the LTE control region.

The LTE control region length and thus the eMTC start symbol depends on the channel bandwidth:

- For "Channel Bandwidth ≥ 3MHz": 1, 2 or 3 symbols
- For "Channel Bandwidth = 1.4 MHz": 2, 3 or 4 symbols

Remote command:

[:SOURce<hw>] :BB:EUTRa:DL:EMTC:BMP:START on page 839

Scheduling Info SIB1-BR ← Bitmap

Sets the higher-level parameter schedulingInfoSIB1-BR-r13 and defines the number of times the PDSCH allocation carrying the SIB1-BR is repeated, see [Table 5-5](#).

Remote command:

[:SOURCE<hw>] :BB:EUTRa:DL:EMTC:BMP:SIBBr on page 839

PBCH Repetition ← Bitmap

For "Channel Bandwidth \geq 3MHz", configures the cell for PBCH repetition.

If enabled, the PBCH is repeated as defined in TS 36.211.

Remote command:

[:SOURCE<hw>] :BB:EUTRa:DL:EMTC:BMP:PBCHrep on page 839

Select All/Deselect All ← Bitmap

Sets all SFs as valid or invalid.

Remote command:

[:SOURCE<hw>] :BB:EUTRa:DL:EMTC:BMP:SElectlall|DEselectall
on page 839

SF State ← Bitmap

Sets an SF as valid or invalid.

If TDD duplexing is used, the UL subframes cannot be used for eMTC transmission.

Remote command:

[:SOURCE<hw>] :BB:EUTRa:DL:EMTC:BMP:VALSubframes<ch> on page 840

Narrowbands

Comprises settings for frequency-hopping configuration.

Number of eMTC Narrowbands ← Narrowbands

Option: R&S SMM-K115

This parameter is **dedicated to eMTC**.

It indicates the number of eMTC narrowbands N_{RB}^{DL} available within the selected channel bandwidth.

The value is calculated as follows:

"Number of Narrowbands" = "Number of Resource Blocks" / 6

For more information, see "Narrowbands" on page 332.

Remote command:

[:SOURCE<hw>] :BB:EUTRa:DL:EMTC:NB:NNBands? on page 840

Number of Narrowbands for Hopping ← Narrowbands

Set the parameter `mpdcch-pdsch-HoppingNB-r13` ($N_{NB,hop}^{ch,DL}$) and defines the number of narrowbands (2 or 4) over which MPDCCH or PDSCH hops.

See also "PDSCH hopping" on page 334.

Remote command:

[:SOURCE<hw>] :BB:EUTRa:DL:EMTC:NB:HOPping on page 840

Hopping Offset ← Narrowbands

Set the parameter `mpdcch-pdsch-HoppingOffset-r13` ($f_{NB,hop}^{DL}$) and defines the number of narrowbands between two consecutive MPDCCH or PDSCH hops.

See also "PDSCH hopping" on page 334.

Remote command:

[:SOURCE<hw>] :BB:EUTRa:DL:EMTC:NB:HOFfset on page 840

Hopping Interval for CE Mode A/B ← Narrowbands

Set the parameter `interval-DLHoppingConfigCommon` ($N_{NB}^{ch,DL}$) and defines the number of consecutive subframes during which MPDCCH or PDSCH stays at the same narrowband before hopping to another narrowband.

Table 5-39: Hopping interval $N_{NB}^{ch,DL}$ value range per CE Mode

Duplexing	CE Mode A	CE Mode B
FDD	1, 2, 4, 8	2, 4, 8, 16
TDD	1, 5, 10, 20	5, 10, 20, 40

See also "PDSCH hopping" on page 334.

Remote command:

[:SOURCE<hw>] :BB:EUTRa:DL:EMTC:NB:IVLA on page 841

[:SOURCE<hw>] :BB:EUTRa:DL:EMTC:NB:IVLB on page 841

RA Hopping ← Narrowbands

Enables hopping for the random access.

Remote command:

[:SOURCE<hw>] :BB:EUTRa:DL:EMTC:NB:RHOPping on page 841

RA Starting NB ← Narrowbands

If "RA Hopping > On", sets the first used narrowband.

Remote command:

[:SOURCE<hw>] :BB:EUTRa:DL:EMTC:NB:RSTNb on page 841

Paging Hopping ← Narrowbands

Enables paging hopping.

Remote command:

[:SOURCE<hw>] :BB:EUTRa:DL:EMTC:NB:PHOPping on page 841

Paging Starting NB ← Narrowbands

If "Paging Hopping > On", sets the first used narrowband.

Remote command:

[:SOURCE<hw>] :BB:EUTRa:DL:EMTC:NB:PSTNb on page 841

5.3.7.2 Search space settings

Access:

1. Select "General > Link Direction > Downlink".
2. Select "General DL Settings > eMTC > Search Space".

3. Select "Frame Configuration > General > User > UEx > Search Space > Config".

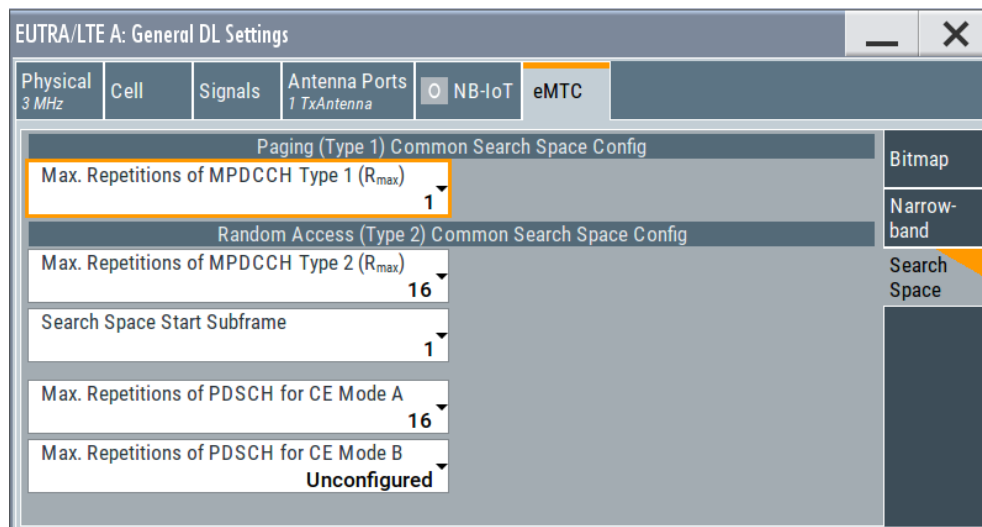

Settings:

Common Search Space.....	432
L Max. Repetitions of MPDCCH (Rmax) for Type 1 common search space...	432
L Max. Repetitions of MPDCCH (Rmax) for Type 2 common search space...	432
L Search Space Start Subframe.....	432
L Max. Repetitions of PDSCH for CE Mode A/B.....	433

Common Search Space

Configures the Type 1 (paging) and Type 2 (random access) common search space.

The common search space defines the MPDCCH candidates that the UE has to monitor.

Max. Repetitions of MPDCCH (Rmax) for Type 1 common search space ← Common Search Space

Sets the maximum number MPDCCH is repeated R_{Max}
(mpdcch-NumRepetitionPaging-r13).

Remote command:

[:SOURce<hw>] :BB:EUTRa:DL:EMTC:SSP:MPD1 on page 842

Max. Repetitions of MPDCCH (Rmax) for Type 2 common search space ← Common Search Space

Sets the maximum number MPDCCH is repeated R_{Max}
(mpdcch-NumRepetitions-RA).

Remote command:

[:SOURce<hw>] :BB:EUTRa:DL:EMTC:SSP:MPD2 on page 842

Search Space Start Subframe ← Common Search Space

Sets the start SF for the random access common search space
(mpdcch-StartSF-CSS-RA).

Remote command:

[:SOURCE<hw>] :BB:EUTRa:DL:EMTC:SSP:STSF on page 842

Max. Repetitions of PDSCH for CE Mode A/B ← Common Search Space

Sets the cell-specific higher-layer parameter `pdsch-maxNumRepetitionCEmodeA/pdsch-maxNumRepetitionCEmodeB` that defines the PDSCH subframe assignment, if the MPDCCH with DCI format 6-1A/6-1B/6-2 is detected.

- DCI format 6-1A: `pdsch-maxNumRepetitionCEmodeA = {Unconfigured, 16, 32}`
- DCI format 6-1B/6-2: `pdsch-maxNumRepetitionCEmodeB = {Unconfigured, 192, 256, ..., 2048}`

These parameters together with the DCI field PDSCH repetition number define the PDSCH repetitions, see "Repetition of PDSCH not carrying SIB1-BR" on page 334.

Remote command:

[:SOURCE<hw>] :BB:EUTRa:DL:EMTC:SSP:PDSA on page 842

[:SOURCE<hw>] :BB:EUTRa:DL:EMTC:SSP:PDSB on page 842

5.3.7.3 eMTC DCI configuration

Access:

1. Select "General > Link Direction > Downlink".
2. Enable at least one eMTC UE, i.e. select "Frame Configuration > General > User > User 1" > "3GPP Release = eMTC CE: A/B".
3. Select "Frame Configuration > General > eMTC > DCI Configuration".
4. Select "Number of DCI Allocations = 1".
5. Configure the DCI allocations, e.g. select "User > User 1", "DCI Format = 6-1A" and "Start Subframe = 0".

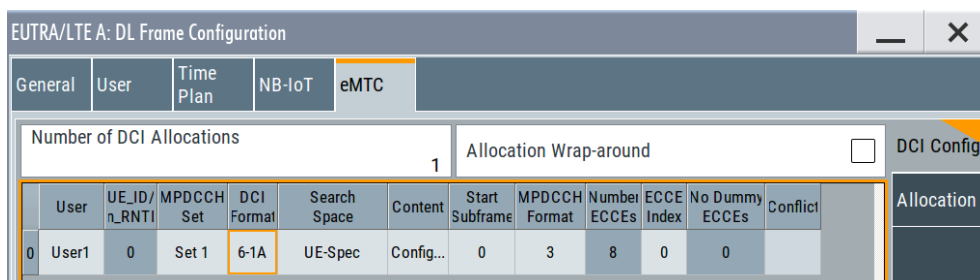

6. For each DCI, select "Content > Config".

Settings:

Number of DCI Allocations..... 434

Allocation Wrap-around..... 434

User..... 434

UE_ID/n_RNTI..... 435

MPDCCH Set..... 435

DCI Format.....	435
Search Space.....	435
DCI Content Configuration.....	436
L Bit Data.....	436
L DCI Format 3/3A.....	436
L DCI Format 6-0A/6-0B.....	436
L DCI Format 6-1A/6-1B.....	438
L DCI Format 6-2.....	441
L Transport Block Size.....	443
L Repetitions of MPDCCH.....	443
L Repetitions of PDSCH.....	443
L PDSCH Hopping.....	443
L Starting Redundancy Version.....	443
Start Subframe.....	443
MPDCCH Format.....	444
Number ECCEs.....	444
ECCE Index.....	444
No. Dummy ECCEs.....	444
Conflict.....	444

Number of DCI Allocations

Sets up to 100 configurable DCIs.

There is one table row per DCI in the DCI table.

The default "Number of DCI Allocations" value depends on the availability of eMTC UEs:

- 0: if all "User" are set to NB-LoT.
Changing the value to "Number of DCI Allocations = 1", enables you to configure P-RNTI or RA-RNTI DCIs.
- 1: if there is at least one "User" with "3GPP Release = eMTC CE: A/B".

Set "Number of DCI Allocations = 0" to disable the DCI-based eMTC configuration.

Remote command:

[:SOURCE<hw>] :BB:EUTRa:DL:EMTC:DCI:NALLoc on page 865

Allocation Wrap-around

An MPDCCH can schedule a PDSCH outside of the selected "ARB Sequence Length".

Enable this parameter to ensure a consistent signal, where the PDSCH allocations are relocated at the beginning of the ARB sequence.

[:SOURCE<hw>] :BB:EUTRa:DL:EMTC:DCI:AWARound on page 865

User

Selects the user the DCI is dedicated to. The available DCI formats depend on the value of this parameter.

"User x" Selects one of the four users with "3GPP Release = eMTC CE: A/B", as configured in the "Frame Configuration > General > User" dialog.

"P-RNTI/RA-RNTI"
 A group of users is selected.

Remote command:

[:SOURCE<hw>] :BB:EUTRa:DL:EMTC:DCI:ALLoc<ch0>:USER on page 866

UE_ID/n_RNTI

Displays the UE_ID of the "User x" or the n_RNTI for the selected DCI.

The UE_ID is set with the parameter "Frame Configuration > General > User > User x" > [UE ID/n_RNTI](#)

Remote command:

[:SOURCE<hw>] :BB:EUTRa:DL:EMTC:DCI:ALLoc<ch0>:UEID? on page 866

MPDCCH Set

Selects the MPDCCH set by which the DCI is carried.

To enable the second set for "User = User x":

- Select "Frame Configuration > General > User > User x > EPDCCH/MPDCCH > Config"
- Set "Set 2 > State > On".

Remote command:

[:SOURCE<hw>] :BB:EUTRa:DL:EMTC:DCI:ALLoc<ch0>:MPDCchset on page 866

DCI Format

Sets the DCI format for the selected allocation.

The downlink control information (DCI) is a message used to control the physical layer resource allocation in the UL and DL direction. It carries scheduling information and uplink power control commands.

Depending on the DCI message usage, they are categorized into the following formats: 3/3A, 6-0A/6-0B, 6-1A/6-1B, 6-2.

See [Table 5-10](#).

To configure the parameters per DCI format, select "Content > Config".

Remote command:

[:SOURCE<hw>] :BB:EUTRa:DL:EMTC:DCI:ALLoc<ch0>:FMT on page 867

Search Space

Defines the search space for the selected DCI.

The search space defines the MPDCCH candidates that the UE has to monitor. The UE can decode only the control information on an MPDCCH that is transmitted over ECCEs within the search space the UE monitors.

"UE-spec" Non-common DCIs are mapped to the UE-specific search space. Each UE has multiple UE-specific search spaces, determined as a function of its UE ID.

"Type 0 Common/Type 1 Common/Type 2 Common"

The DCI is mapped to the common search space, where:

- Type 1 common search space is used for paging
- Type 2 for random access
- Type 0 common search space is available for "User x > 3GPP Release = eMTC CE-Mode A".

A common search space is used to address all or a group of UEs.

Remote command:

[:SOURCE<hw>] :BB:EUTRa:DL:EMTC:DCI:ALLoc<ch0>:SSP on page 867

DCI Content Configuration

Configure the parameters per DCI format.

The fields defined in the DCI format are mapped to the information bits according to the 3GPP specification.

The resulting [Transport Block Size](#), [Repetitions of MPDCCH](#), [Repetitions of PDSCH](#), [PDSCH Hopping](#) and [Starting Redundancy Version](#) values are displayed.

Bit Data ← DCI Content Configuration

Displays the resulting bit data as selected with the DCI format parameters.

The first bit in DCI formats pairs 6-0A and 6-1A, and 6-0B and 6-1B is used as flag to distinguish between the two formats in a pair. It is set as follows:

- DCI format 6-0A/6-0B: First bit = 0
- DCI format 6-1A/6-1B: First bit = 1

Mapping of the information bits is according to [TS 36.212](#).

Remote command:

[:SOURCE<hw>] :BB:EUTRa:DL:EMTC:DCI:ALLoc<ch0>:BITS? on page 868

DCI Format 3/3A ← DCI Content Configuration

The DCI Format 3/3A is used for the transmission of TPC Commands for MPUCCH and PUSCH with 2-bit and a single bit power adjustment respectively.

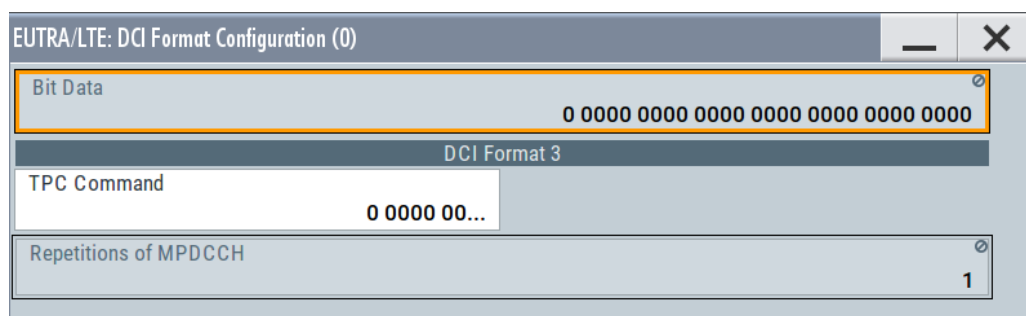

The "TPC Command" is set as a bit pattern.

Remote command:

[:SOURCE<hw>] :BB:EUTRa:DL:EMTC:DCI:ALLoc<ch0>:TCMD on page 870

DCI Format 6-0A/6-0B ← DCI Content Configuration

The DCI formats 6-0A and 6-0B are used for scheduling of PUSCH in one UL cell, where the formats are used in CE Mode A and CE Mode B respectively.

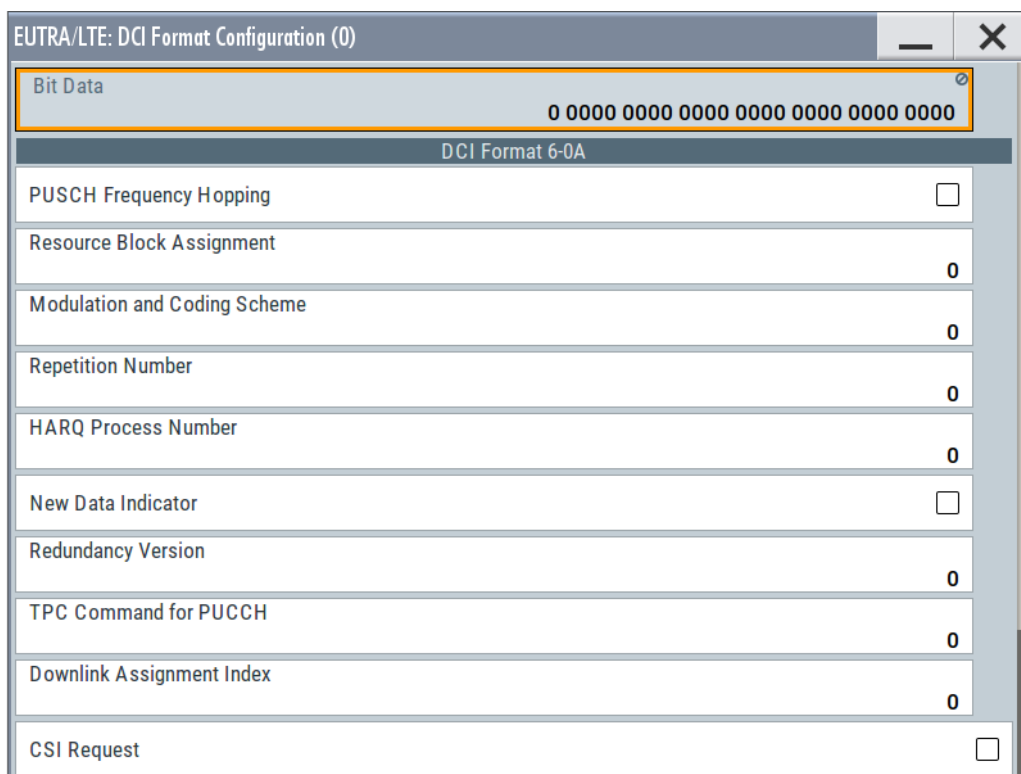

DCI format 6-0A and 6-0B transmit the information listed in [Table 5-40](#).

Among other, these DCIs carry information on:

- "PUSCH Frequency Hopping": sets the hopping dynamically on a per transmission basis.
This field has higher priority as the cell-specific hopping configuration, see [Chapter 5.3.8.1, "Cell-specific eMTC PUSCH settings"](#), on page 460.
- "Repetition Number": sets the PUSCH repetition level (n_1 to n_4 or n_8 in DCI formats 6-0A and 6-0B)
- "DCI Subframe Repetition Number": sets the MPDCCH repetition level (r_1 to r_4), see ["MPDCCH repetition number"](#) on page 339.

Table 5-40: DCI format 6-0A and 6-0B control information fields

Control Information Field	SCPI command	Dependencies
"PUSCH Frequency Hopping"	[:SOURCE<hw>] :BB:EUTRa:DL:EMTC:DCI:ALLoc<ch0>:PFRHopp on page 871	DCI Format 6-0A
"Resource Block Assignment"	[:SOURCE<hw>] :BB:EUTRa:DL:EMTC:DCI:ALLoc<ch0>:RBA on page 871	See Table 5-41 .
"Modulation and Coding Scheme"	[:SOURCE<hw>] :BB:EUTRa:DL:EMTC:DCI:ALLoc<ch0>:MCS on page 871	
"Repetition Number"	[:SOURCE<hw>] :BB:EUTRa:DL:EMTC:DCI:ALLoc<ch0>:NREP on page 872	"DCI Format 6-0A": 0 to 3 "DCI Format 6-0B": 0 to 7

Control Information Field	SCPI command	Dependencies
"HARQ Process Number"	[:SOURCE<hw>] :BB:EUTRa:DL:EMTC:DCI:ALLoc<ch0>:HARQ on page 872	"DCI Format 6-0A": 0 to 7 "DCI Format 6-0B": 0 to 1
"New Data Indicator"	[:SOURCE<hw>] :BB:EUTRa:DL:EMTC:DCI:ALLoc<ch0>:NDINd on page 872	
"Redundancy Version"	[:SOURCE<hw>] :BB:EUTRa:DL:EMTC:DCI:ALLoc<ch0>:RVER on page 872	DCI Format 6-0A
"TPC Command for Scheduled PUSCH"	[:SOURCE<hw>] :BB:EUTRa:DL:EMTC:DCI:ALLoc<ch0>:TPCPusch on page 873	DCI Format 6-0A
"UL Index"	[:SOURCE<hw>] :BB:EUTRa:DL:EMTC:DCI:ALLoc<ch0>:ULINdex on page 873	DCI Format 6-0A TDD mode and "UL/DL Configuration = 0"
"Downlink Assignment Index (DAI)"	[:SOURCE<hw>] :BB:EUTRa:DL:EMTC:DCI:ALLoc<ch0>:DAINdex on page 873	DCI Format 6-0A TDD mode and "UL/DL Configuration = 1 to 6"
"CSI Request"	[:SOURCE<hw>] :BB:EUTRa:DL:EMTC:DCI:ALLoc<ch0>:CSIRequest on page 874	DCI Format 6-0A
"SRS Request"	[:SOURCE<hw>] :BB:EUTRa:DL:EMTC:DCI:ALLoc<ch0>:SRSRequest on page 874	DCI Format 6-0A
"DCI Subframe Repetition Number"	[:SOURCE<hw>] :BB:EUTRa:DL:EMTC:DCI:ALLoc<ch0>:SFRNumber on page 874	For "MPDCCH > Max. Repetitions for MPDCCH Rmax ≥ 2"

Table 5-41: Control information field Resource Block Assignment value range

Channel Bandwidth	DCI Format 6-0A	DCI Format 6-0B
1.4 MHz	0 to 31	0 to 7
3 MHz	0 to 63	0 to 15
5 MHz	0 to 127	0 to 31
10 MHz	0 to 255	0 to 63
15/20 MHz	0 to 511	0 to 127

In certain cases defined in TS 36.212, zeros are appended to the DCI format 6-0B until its payload size is equal to the size of DCI format 6-0A.

DCI Format 6-1A/6-1B ← DCI Content Configuration

DCI formats 6-1A and 6-1B are used for the compact scheduling of one PDSCH code-word in one cell and random access procedure initiated by a PDCCH order. The two formats are used in CE Mode A and CE Mode B respectively.

EUTRA/LTE: DCI Format Configuration (1)

Bit Data: 10 1000 0000 0000 0000 0000 0000 0000

DCI Format 61A

Mode	PDSCH	PDSCH Frequency Hopping	<input type="checkbox"/>
Resource Block Assignment Flag	<input checked="" type="checkbox"/>	Resource Block Assignment	0
Modulation and Coding Scheme	0	Repetition Number	0
Redundancy Version	0	TPC Command for PUCCH	0
CSI Request	<input type="checkbox"/>	SRS Request	<input type="checkbox"/>
		Subframe Repetition Number	0
Transport Block Size	40	Repetitions of MPDCCH	1
Repetitions of PDSCH	0	PDSCH Hopping	Off
Starting Redundancy Version	0		

DCI format 6-1A and 6-1B transmit the information listed in [Table 5-42](#) and [Table 5-43](#), for PDSCH or PRACH mode respectively.

In certain cases defined in [TS 36.212](#), zeros are appended to:

- DCI format 6-1A until its payload size is equal to the size of DCI format 6-0A
- DCI format 6-1B until its payload size is equal to the size of DCI format 6-0B.

Among other, these DCIs carry information on:

- "PDSCH Frequency Hopping": sets the hopping dynamically on a per transmission basis. This field has higher priority as the cell-specific hopping configuration.
- "Repetition Number": sets the PDSCH repetition level (n_1 to n_4 or n_8 in DCI formats 6-0A and 6-0B), see ["Repetition of PDSCH not carrying SIB1-BR"](#) on page 334.
- "DCI Subframe Repetition Number": sets the MPDCCH repetition level (r_1 to r_4), see ["MPDCCH repetition number"](#) on page 339.
- "Resource Block Assignment": defines the PDSCH [Start NB](#) and [No. RB](#)

Table 5-42: Control information fields in Mode = PDSCH

Control Information Field	SCPI command	Dependencies
"Mode"	[:SOURCE<hw>] :BB:EUTRa:DL:EMTC:DCI:ALLOc<ch0>: UEMode on page 874	
"Frequency Hopping"	[:SOURCE<hw>] :BB:EUTRa:DL:EMTC:DCI:ALLOc<ch0>: PFRHopp on page 871	DCI Format 6-1A

eMTC/NB-IoT-specific configuration and settings

Control Information Field	SCPI command	Dependencies
"Resource Block Assignment Flag"	[:SOURCE<hw>] :BB:EUTRa:DL:EMTC:DCI:ALLoc<ch0>:RBAF? on page 871	Option: R&S SMM-K143 DCI Format 6-1A "Channel Bandwidth = 20 MHz" and "Wideband Config = 20 MHz"
"Resource Block Assignment"	[:SOURCE<hw>] :BB:EUTRa:DL:EMTC:DCI:ALLoc<ch0>:RBA on page 871	See Table 5-44.
"Modulation and Coding Scheme"	[:SOURCE<hw>] :BB:EUTRa:DL:EMTC:DCI:ALLoc<ch0>:MCS on page 871	<ul style="list-style-type: none"> DCI Format 6-1A: 0 to 15 DCI Format 6-1B: 0 to 10
"Repetition Number"	[:SOURCE<hw>] :BB:EUTRa:DL:EMTC:DCI:ALLoc<ch0>:NREP on page 872	
"HARQ Process Number"	[:SOURCE<hw>] :BB:EUTRa:DL:EMTC:DCI:ALLoc<ch0>:HARQ on page 872	"User x" <ul style="list-style-type: none"> FDD: 0 to 7 TDD: 0 to 15
"New Data Indicator"	[:SOURCE<hw>] :BB:EUTRa:DL:EMTC:DCI:ALLoc<ch0>:NDINd on page 872	"User x"
"Redundancy Version"	[:SOURCE<hw>] :BB:EUTRa:DL:EMTC:DCI:ALLoc<ch0>:RVER on page 872	DCI Format 6-1A
"TPC Command for PUCCH"	[:SOURCE<hw>] :BB:EUTRa:DL:EMTC:DCI:ALLoc<ch0>:TPCPusch on page 873	DCI Format 6-1A
"Downlink Assignment Index (DAI)"	[:SOURCE<hw>] :BB:EUTRa:DL:EMTC:DCI:ALLoc<ch0>:DAINdex on page 873	DCI Format 6-1A "User x" TDD mode and "UL/DL Configuration = 1 to 6"
"Antenna Ports and Scrambling Identity"	[:SOURCE<hw>] :BB:EUTRa:DL:EMTC:DCI:ALLoc<ch0>:APSI on page 875	DCI Format 6-1A "User x" with "Tx Mode = TM9" and "Search Space = UE-specific"
"CSI Request"	[:SOURCE<hw>] :BB:EUTRa:DL:EMTC:DCI:ALLoc<ch0>:CSIRequest on page 874	DCI Format 6-1A
"SRS Request"	[:SOURCE<hw>] :BB:EUTRa:DL:EMTC:DCI:ALLoc<ch0>:SRSRequest on page 874	DCI Format 6-1A
"TPMI Information for Precoding"	[:SOURCE<hw>] :BB:EUTRa:DL:EMTC:DCI:ALLoc<ch0>:TPMPrec on page 875	DCI Format 6-1A "User x" with "Tx Mode = TM6" and "Search Space = UE-specific"

Control Information Field	SCPI command	Dependencies
"PMI Confirmation for Precoding"	[:SOURCE<hw>] :BB:EUTRa:DL:EMTC:DCI:ALLoc<ch0> : PMIConfirm on page 875	DCI Format 6-1A "User x" with "Tx Mode = TM6" and "Search Space = UE-specific"
"HARQ-ACK Ressource Offset"	[:SOURCE<hw>] :BB:EUTRa:DL:EMTC:DCI:ALLoc<ch0> : HRESoffset on page 875	"User x"
"DCI Subframe Repetition Number"	[:SOURCE<hw>] :BB:EUTRa:DL:EMTC:DCI:ALLoc<ch0> : SFRNumber on page 874	For "MPDCCH > Max. Repetitions for MPDCCH Rmax ≥ 2"

Table 5-43: Control information fields in Mode = PRACH

Control Information Field	SCPI command	Dependencies
"Mode"	[:SOURCE<hw>] :BB:EUTRa:DL:EMTC:DCI:ALLoc<ch0> : UEMode on page 874	
"Resource Block Assignment"	[:SOURCE<hw>] :BB:EUTRa:DL:EMTC:DCI:ALLoc<ch0> : RBA on page 871	DCI Format 6-1A See Table 5-44.
"Preamble Index"	[:SOURCE<hw>] :BB:EUTRa:DL:EMTC:DCI:ALLoc<ch0> : PRAPreamble on page 876	
"PRACH Mask Index"	[:SOURCE<hw>] :BB:EUTRa:DL:EMTC:DCI:ALLoc<ch0> : PRAMask on page 876	
"Starting CE Level"	[:SOURCE<hw>] :BB:EUTRa:DL:EMTC:DCI:ALLoc<ch0> : PRASStart on page 876	

Table 5-44: Control information field Resource Block Assignment value range

Channel Bandwidth	DCI Format 6-1A PDSCH and PRACH modes	DCI Format 6-1B
1.4 MHz	0 to 31	0 to 1
3 MHz	0 to 63	0 to 3
5 MHz	0 to 127	0 to 7
10 MHz	0 to 255	0 to 15
15/20 MHz	0 to 511	0 to 31

DCI Format 6-2 ← DCI Content Configuration

The DCI format 6-2 is used for paging and direct indication. It is available for "User = P-RNTI".

EUTRA/LTE: DCI Format Configuration (0)	
Bit Data	1000 0000 0000
DCI Format 6-2	
Flag for Paging/Direct Indication	<input checked="" type="checkbox"/>
Resource Block Assignment	0
Modulation and Coding Scheme	0
Repetition Number	0
Subframe Repetition Number	0
Transport Block Size	40
Repetitions of MPDCCH	1
Repetitions of PDSCH	1
Starting Redundancy Version	0

DCI format 6-2 transmits the following information.

Control Information Field	SCPI command	Dependencies
"Flag for Paging/Direct Indication"	[:SOURCE<hw>] :BB :EUTRa :DL :EMTC :DCI :ALLoc<ch0> : PAGNg on page 876	
"Direct Indication Information"	[:SOURCE<hw>] :BB :EUTRa :DL :EMTC :DCI :ALLoc<ch0> : DIINfo on page 877	
"Modulation and Coding Scheme"	[:SOURCE<hw>] :BB :EUTRa :DL :EMTC :DCI :ALLoc<ch0> : MCS on page 871	
"Resource Block Assignment"	[:SOURCE<hw>] :BB :EUTRa :DL :EMTC :DCI :ALLoc<ch0> : RBA on page 871	Value range depends on the "Channel Bandwidth": <ul style="list-style-type: none"> • 1.4 MHz: 0 • 3 MHz: 0 to 1 • 5 MHz: 0 to 3 • 10 MHz: 0 to 7 • 15 MHz: 0 to 12 • 20 MHz: 0 to 15

Control Information Field	SCPI command	Dependencies
"Repetition Number"	[:SOURCE<hw>] :BB:EUTRa:DL:EMTC:DCI:ALLoc<ch0>:NREP on page 872	See "Repetition of PDSCH not carrying SIB1-BR" on page 334.
"DCI Subframe Repetition Number"	[:SOURCE<hw>] :BB:EUTRa:DL:EMTC:DCI:ALLoc<ch0>:SFRNumber on page 874	For "MPDCCH > Max. Repetitions for MPDCCH Rmax ≥ 2"

Transport Block Size ← DCI Content Configuration

Indicates the TBS, calculated for the selected "Modulation and Coding Scheme" and "Resource Assignment Field".

Remote command:

[:SOURCE<hw>] :BB:EUTRa:DL:EMTC:DCI:ALLoc<ch0>:TBS? on page 869

Repetitions of MPDCCH ← DCI Content Configuration

Displays the resulting number of MPDCCH repetitions, calculated for the selected "DCI Subframe Repetition Number".

See "MPDCCH repetition number" on page 339.

Remote command:

[:SOURCE<hw>] :BB:EUTRa:DL:EMTC:DCI:ALLoc<ch0>:REPMpdccch?
on page 869

Repetitions of PDSCH ← DCI Content Configuration

Displays the resulting number of PDSCH repetitions, calculated from the selected "Repetition Number".

See "Repetition of PDSCH not carrying SIB1-BR" on page 334.

Remote command:

[:SOURCE<hw>] :BB:EUTRa:DL:EMTC:DCI:ALLoc<ch0>:REPPdsch?
on page 870

PDSCH Hopping ← DCI Content Configuration

Indicates if PDSCH hopping is enabled or not, as set with the DCI form 6-1A/B field "PDSCH Frequency Hopping".

Remote command:

[:SOURCE<hw>] :BB:EUTRa:DL:EMTC:DCI:ALLoc<ch0>:PDSHopping?
on page 870

Starting Redundancy Version ← DCI Content Configuration

Indicates the starting RV, calculated from the value of the "Redundancy Version" field.

Remote command:

[:SOURCE<hw>] :BB:EUTRa:DL:EMTC:DCI:ALLoc<ch0>:STRV? on page 870

Start Subframe

Sets the next valid starting subframe for the particular MPDCCH.

Remote command:

[:SOURce<hw>] :BB:EUTRa:DL:EMTC:DCI:ALLoc<ch0>:STSFrame on page 867

MPDCCH Format

Selects one of the five MPDCCH formats, where the available values depend on the "Search Space":

- "Search Space = UE-spec": MPDCCH formats 0 to 5
- "Search Space = Type 0 common": MPDCCH formats 2, 3 and 5
- "Search Space = Type 1 common": MPDCCH format 5
- "Search Space = Type 2 common": MPDCCH formats 2, 3 and 5

MPDCCH format defines the "Number ECCEs", see [Table 5-6](#).

Remote command:

[:SOURce<hw>] :BB:EUTRa:DL:EMTC:DCI:ALLoc<ch0>:PDCCh on page 867

Number ECCEs

MPDCCH is transmitted on an aggregation of one or two consecutive control channel elements (ECCE).

The value is selected automatically, depending on the selected MPDCCH format, see [Table 5-6](#).

Remote command:

[:SOURce<hw>] :BB:EUTRa:DL:EMTC:DCI:ALLoc<ch0>:CCES? on page 868

ECCE Index

For UE-specific search space, sets the ECCE start index.

The available ECCEs depend on the selected [MPDCCH Format](#).

ECCE index	Occupied subcarriers per subframe
0	0 to 5
1	6 to 11

See also [Figure 5-14](#).

Remote command:

[:SOURce<hw>] :BB:EUTRa:DL:EMTC:DCI:ALLoc<ch0>:IDCCe on page 868

No. Dummy ECCEs

Indicates the number of dummy ECCEs that are appended to the corresponding MPDCCH.

Remote command:

[:SOURce<hw>] :BB:EUTRa:DL:EMTC:DCI:ALLoc<ch0>:NDCCes? on page 868

Conflict

Indicates a conflict between two DCI formats, for example if they have the same ECCE index and start subframe.

Remote command:

[:SOURce<hw>] :BB:EUTRa:DL:EMTC:DCI:ALLoc<ch0>:CONFLICT? on page 869

5.3.7.4 eMTC allocations (PBCH, MPDCCH, PDSCH)

Access:

1. Select "General > Link Direction > Downlink".
2. Select "Frame Configuration > General > eMTC > Allocation".
3. Select "ρ A" to boost the power of a particular allocation.

EUTRA/LTE A: DL Frame Configuration															
General		Time Plan		NB-LoT		eMTC								DCI Config	
	Content Type	Modulation	Enh. Sett.	Start SF	Num. Abs. SF	Start NB	Start Sym.	No. RB	Offs. VRB	Phys. Bits	Data Source	DList / Pattern	ρ A /dB	St.	C.
0	PBCH	QPSK	Config...	0	-	-	2	Auto	-	480	MIB	-	0.00	On	
1	PDSCH	QPSK		0	0	0	3	6	0	1510	SIB1-BR	-	0.00	On	
2	MPDCCH	QPSK	Config...	0	4	0	2	Auto	Auto	432	User1	-	0.00	On	
3	PDSCH	QPSK	Config...	5	8	0	2	1	0	276	User1	-	0.00	On	

The PBCH allocation and the SIB1-BR transmissions are configured automatically, but the PBCH allocation can be changed.

The PDSCH and MPDCCH allocations are configured according to the current DCI configuration, see [Chapter 5.3.7.3, "eMTC DCI configuration"](#), on page 433. Merely some of the PDSCH precoding settings can be adjusted and scrambling and channel coding disabled.

Settings:

Allocation number	445
Content Type	445
Modulation	446
Enhanced Settings > Config	446
Start SF	446
Num. Abs. SF	447
Start NB	447
Start Symbol	447
No. RB	447
Offset VRB	447
Phys. Bits	447
Data Source	447
ρ A	448
State	448
Conflict	448

Allocation number

Consecutive number of the allocation.

Content Type

Indicates the channel type.

Allocation number	Channel	Description
0	PBCH	Broadcast channel
1	<ul style="list-style-type: none"> PDSCH SIB1-BR MPDCCH 	<ul style="list-style-type: none"> If PBCH is scheduled and Scheduling Info SIB1-RB ≥ 1, one PDSCH that carries the SIB1-BR message is automatically configured Otherwise, MPDCCH is configured
> 1	<ul style="list-style-type: none"> MPDCCH MPDCCH and PDSCH 	Allocated automatically, depending on the current DCI configuration, Chapter 5.3.7.3, "eMTC DCI configuration" , on page 433: <ul style="list-style-type: none"> One MPDCCH per P-RNTI, RA-RNTI and DCI of an active eMTC user, see "Configure User" > 3GPP Release One pair per: <ul style="list-style-type: none"> DCI format 6-1A/B used for PDSCH scheduling of an active eMTC user or RA-RNTI DCI format 6-2 with "Flag for Paging/Direct Indication = On".

Remote command:

[\[:SOURCE<hw>\]:BB:EUTRa:DL:EMTC:ALLoc<ch0>:CONTType?](#) on page 877

Modulation

Indicates the modulation per channel.

eMTC allocations are QPSK modulated, but the PDSCH allocations not carrying SIB1-BR can also use 16QAM. The modulation scheme in the latter case is defined by the DCI filed "Modulation and Coding Scheme".

Remote command:

[\[:SOURCE<hw>\]:BB:EUTRa:DL:EMTC:ALLoc<ch0>:MODulation?](#) on page 878

Enhanced Settings > Config

Accesses the precoding, scrambling and channel coding settings of the selected channel, see [Chapter 5.3.7.6, "PDSCH channel coding and scrambling"](#), on page 452.

To configure the MPDCCH settings, select "Frame Configuration > General > User > User x > 3GPP Release = CE Mode A/B > EPDCCH/MPDCCH > Config".

Start SF

Indicates the first subframe where the channel can be allocated.

PBCH and PDSCH carrying SIB1-BR always start in the first subframe.

The start subframe of a PDSCH allocation associated with an MPDCCH transmission is calculated as follows:

$$\text{Start SF}_{\text{PDSCH}} = \text{Start SF}_{\text{MPDCCH}} + N_{\text{abs}}^{\text{MPDCCH}} + 2$$

Where $N_{\text{abs}}^{\text{MPDCCH}}$ depends on the $N_{\text{rep}}^{\text{MPDCCH}}$ and the valid eMTC DL subframes, see:

- "[Repetitions of MPDCCH](#)" on page 443
- "[SF State](#)" on page 430

Remote command:

[\[:SOURCE<hw>\]:BB:EUTRa:DL:EMTC:ALLoc<ch0>:STSFframe?](#) on page 878

Num. Abs. SF

Indicates the number of absolute subframes, i.e. number of subframes the allocation spans.

Remote command:

[:SOURCE<hw>] :BB:EUTRa:DL:EMTC:ALLoc<ch0>:ABSFrames? on page 878

Start NB

Indicates the first narrowband where the channel can be allocated.

- For MPDCCH, the value resembles the one set with the parameter "User > MPDCCH Config" > [Starting NB](#)
- For PDSCH not carrying SIB1-BR, the value is determined by the DCI field "3GPP Release = CE Mode A".
- The scheduling and hopping pattern of the PDSCH carrying SIB1-BR incl. all related parameter is performed automatically, as defined in [TS 36.211](#).

Remote command:

[:SOURCE<hw>] :BB:EUTRa:DL:EMTC:ALLoc<ch0>:STNB? on page 879

Start Symbol

Indicates the first symbol where the channel can be allocated.

The PDSCH carrying SIB1-BR starts always at symbol#3. The start symbol for all other allocations resembles the value set with "General Settings > eMTC > Bitmap" > [Starting Symbol](#).

Remote command:

[:SOURCE<hw>] :BB:EUTRa:DL:EMTC:ALLoc<ch0>:STSymbol? on page 879

No. RB

Indicates used number of resource blocks and thus the allocation's bandwidth.

For PDSCH not carrying SIB1-BR, the value is determined by the DCI field "3GPP Release = CE Mode A".

Remote command:

[:SOURCE<hw>] :BB:EUTRa:DL:EMTC:ALLoc<ch0>:NORB? on page 879

Offset VRB

Values different than 0 indicate resource block shift within the narrowbands.

Remote command:

[:SOURCE<hw>] :BB:EUTRa:DL:EMTC:ALLoc<ch0>:OVRB? on page 879

Phys. Bits

Displays the allocation size in bits. The value is calculated similar to the physical bits value in NB-IoT, see ["Phys. Bits"](#) on page 396.

Remote command:

[:SOURCE<hw>] :BB:EUTRa:DL:EMTC:ALLoc<ch0>:PHYSbits? on page 880

Data Source

Indicates the data source depending on the "Content Type".

The data source is configurable for:

- PBCH with "PBCH > Config > Channel Coding > MIB (including SFN) = Off"
- PDSCH SIB1-BR allocation
- PDSCH allocations that are configured for "eMTC > DCI Config > User = P-RNTI or RA-RNTI"

The following standard data sources are available:

- "All 0, All 1"
An internally generated sequence containing 0 data or 1 data.
- "PNxx"
An internally generated pseudo-random noise sequence.
- "Pattern"
An internally generated sequence according to a bit pattern.
Use the "Pattern" box to define the bit pattern.
- "Data List/Select DList"
A binary data from a data list, internally or externally generated.
Select "Select DList" to access the standard "Select List" dialog.
 - Select the "Select Data List > navigate to the list file *.dm_iqd > Select" to select an existing data list.
 - Use the "New" and "Edit" functions to create internally new data list or to edit an existing one.
 - Use the standard "File Manager" function to transfer external data lists to the instrument.

See also:

- Section "Modulation Data" in the R&S SMM100A user manual.
- Section "File and Data Management" in the R&S SMM100A user manual.
- Section "Data List Editor" in the R&S SMM100A user manual

Remote command:

[:SOURce<hw>] :BB:EUTRa:DL:EMTC:ALLoc<ch0>:DATA on page 880
 [:SOURce<hw>] :BB:EUTRa:DL:EMTC:ALLoc<ch0>:DSElect on page 880
 [:SOURce<hw>] :BB:EUTRa:DL:EMTC:ALLoc<ch0>:PATTern on page 881

p A

Sets the power P_{MPDCCH} or P_{PDSCH} (ρ A) of the selected allocation.

Remote command:

[:SOURce<hw>] :BB:EUTRa:DL:EMTC:ALLoc<ch0>:POWer on page 881

State

Indicates that the allocation is active.

Remote command:

[:SOURce<hw>] :BB:EUTRa:DL:EMTC:ALLoc<ch0>:STATe? on page 881

Conflict

Indicates a conflict between allocations.

Remote command:

[:SOURce<hw>] :BB:EUTRa:DL:EMTC:ALLoc<ch0>:CONFlict? on page 882

5.3.7.5 PBCH channel coding and SIB-BR configuration

Access:

1. Select "General > Link Direction > Downlink".
2. Select "Frame Configuration > eMTC > Allocation".
3. Select "PBCH > Enhanced Settings > Config".

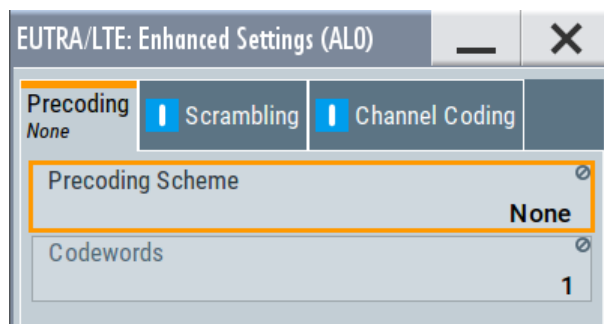

PBCH can be generated in one of the following modes:

- Without channel coding, if "Channel Coding > State > Off"
Dummy data or user-defined data lists are used.
- Channel coding with arbitrary transport block content
If channel coding is activated ("Channel Coding > State > On") and parameter "MIB (including SFN) > Off"
- Channel coding with real data (MIB) including SFN
If channel coding and "MIB (including SFN)" are activated
This mode is required for the generation of SIB1-BR message.

Settings:

Precoding.....	450
L Precoding Scheme.....	450
L Number of Layers.....	450
Scrambling.....	450
L Scrambling State.....	450
L UE ID/n_RNTI.....	450
Channel Coding.....	450
L Channel Coding State.....	450
L Type Channel Coding.....	451
L Number of Physical Bits.....	451
L MIB (including SFN).....	451
L SFN Offset.....	451
L SFN Restart Period.....	451
L Scheduling Info SIB1-RB.....	452
L PDSCH Repetitions SIB1-RB.....	452
L MIB Spare Bits.....	452
L Transport Block Size/Payload (DL).....	452

Precoding

Comprises the precoding settings.

Most of the parameters are set automatically, depending on the selected:

- [Tx Mode] of the corresponding UE ("Frame Configuration > UEx > Tx Mode")
- Number of Tx antennas ("General DL Settings > Antenna Ports > Global MIMO Configuration")

See also [Table 5-11](#).

Precoding Scheme ← Precoding

Selects the precoding scheme.

"None" Disables precoding.

"Tx Diversity" If "Global MIMO Configuration \geq 2 Tx Antennas", select precoding for transmit diversity.

Remote command:

```
[ :SOURCE<hw> ] :BB:EUTRa:DL:EMTC:ALLoc<ch0>:PRECoding:SCHEME
on page 883
```

Number of Layers ← Precoding

Displays the number of layers for the selected allocation.

Remote command:

```
[ :SOURCE<hw> ] :BB:EUTRa:DL:EMTC:ALLoc<ch0>:PRECoding:NOLayers?
on page 883
```

Scrambling

Comprises the scrambling settings.

Scrambling State ← Scrambling

Enables scrambling.

Remote command:

```
[ :SOURCE<hw> ] :BB:EUTRa:DL:EMTC:ALLoc<ch0>:SCRambling:STATE
on page 887
```

UE ID/n_RNTI ← Scrambling

Indicates the user equipment identifier (n_RNTI) or UE ID of the user to which the PDSCH transmission is intended. The displayed "UE ID/n_RNTI" value is used to calculate the scrambling sequence.

Remote command:

```
[ :SOURCE<hw> ] :BB:EUTRa:DL:EMTC:ALLoc<ch0>:SCRambling:UEID?
on page 888
```

Channel Coding

Comprises the channel coding settings. Channel coding state is configurable. All other settings are configured automatically.

Channel Coding State ← Channel Coding

Enables channel coding.

Remote command:

`[:SOURCE<hw>] :BB:EUTRa:DL:EMTC:ALLoc<ch0>:CCODing:STATE`
on page 888

Type Channel Coding ← Channel Coding

Displays the used channel coding scheme and channel coding rate.

PBCH uses always tail biting convolution coding with code rate 1/3; PDSCH uses always turbo code with code rate 1/3.

Remote command:

n.a.

Number of Physical Bits ← Channel Coding

Indicates the calculated number of physical bits; resembles the information displayed with parameter [Phys. Bits](#).

Remote command:

`[:SOURCE<hw>] :BB:EUTRa:DL:EMTC:ALLoc<ch0>:PHYSbits?` on page 880

MIB (including SFN) ← Channel Coding

Enables transmission of real MIB (master information block) data. The SFN (system frame number) is included as well.

Remote command:

`[:SOURCE<hw>] :BB:EUTRa:DL:EMTC:ALLoc<ch0>:CCODing:MIB` on page 889

SFN Offset ← Channel Coding

By default, the counting of the SFN (system frame number) starts with 0. This parameter sets a different start SFN value.

Remote command:

`[:SOURCE<hw>] :BB:EUTRa:DL:EMTC:ALLoc<ch0>:CCODing:SOFFset`
on page 890

SFN Restart Period ← Channel Coding

Determines the time span after which the SFN (system frame number) restarts.

"Sequence Length"

The SFN restart period is equal to the ARB sequence length.

"3GPP (1024 Frames)"

The PBCH including SFN is calculated independently from the other channels. The SFN restarts after 1024 frames and the generation process is fully 3GPP compliant, but the calculation can take long time.

Tip: Use the "3GPP (1024 Frames)" mode only if 3GPP compliant SFN period is required.

This mode is disabled if a baseband generates more than one carrier.

Remote command:

`[:SOURCE<hw>] :BB:EUTRa:DL:EMTC:ALLoc<ch0>:CCODing:SRPeriod`
on page 890

Scheduling Info SIB1-RB ← Channel Coding

Sets the parameter `schedulingInfoSIB1-RB` that defines the PDSCH number of repetitions $N_{\text{Rep}}^{\text{PDSCH}}$. the resulting value is indicated with [PDSCH Repetitions SIB1-RB](#).

The parameter works like the setting "General DL > eMTC > Bitmap" > [Scheduling Info SIB1-BR](#).

For "Scheduling Info SIB1-RB = 0" there is no PDSCH carrying SIB1-BR scheduled and hence no such allocation in the eMTC allocation table.

Remote command:

`[:SOURCE<hw>] :BB:EUTRa:DL:EMTC:ALLoc<ch0>:CCODing:SIB` on page 889

PDSCH Repetitions SIB1-RB ← Channel Coding

Indicates the number of PDSCH repetitions $N_{\text{Rep}}^{\text{PDSCH}}$, as defined with the parameter [Scheduling Info SIB1-RB](#).

Remote command:

`[:SOURCE<hw>] :BB:EUTRa:DL:EMTC:ALLoc<ch0>:CCODing:RSIB?`

on page 890

MIB Spare Bits ← Channel Coding

Sets the 5 spare bits in the PBCH transmission.

Remote command:

`[:SOURCE<hw>] :BB:EUTRa:DL:EMTC:ALLoc<ch0>:CCODing:MSpare`

on page 890

Transport Block Size/Payload (DL) ← Channel Coding

Displays the size of the transport block/payload in bits.

Remote command:

`[:SOURCE<hw>] :BB:EUTRa:DL:EMTC:ALLoc<ch0>:CCODing:TBSize?`

on page 888

5.3.7.6 PDSCH channel coding and scrambling

Access:

1. Select "General > Link Direction > Downlink".
2. Select "Frame Configuration > General > eMTC > Allocation".
3. Select "PDSCH > Enhanced Settings > Config".

The displayed settings depends on the:

- Number of Tx antennas ("General DL Settings > Antenna Ports > Global MIMO Configuration")
- "Tx Mode" of the corresponding UE.

See also [Table 5-11](#).

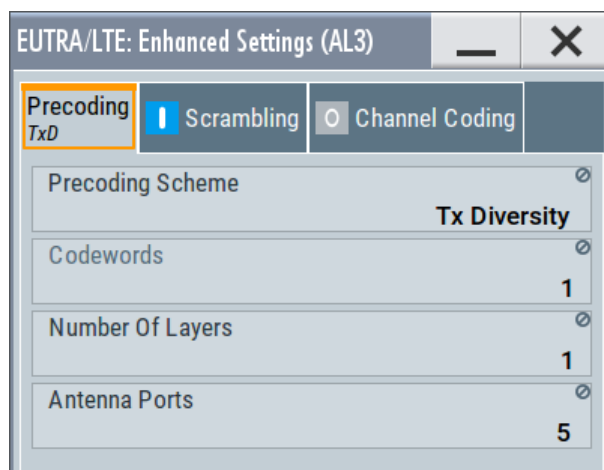
**Settings:**

Precoding.....	453
L Precoding Scheme.....	453
L Transmission Scheme.....	454
L Number of Layers.....	454
L Codeword.....	454
L Cyclic Delay Diversity.....	454
L Codebook Index.....	454
L Antenna Ports.....	454
L Scrambling Identity n_SCID.....	455
L Antenna Port Mapping.....	455
L Mapping Coordinates.....	455
L Mapping Table.....	455
Scrambling.....	455
L Scrambling State.....	456
L UE ID/n_RNTI.....	456
Channel Coding.....	456
L Channel Coding State.....	456
L Type Channel Coding.....	457
L Number of Physical Bits.....	457
L Transport Block Size I_{TBS}	457
L Transport Block Size/Payload (DL).....	457

Precoding

Comprises the precoding settings.

Most of the parameters are set automatically, depending on the selected:

- "Tx Mode" of the corresponding UE ("Frame Configuration > UEx > Tx Mode")
- Number of Tx antennas ("General DL Settings > Antenna Ports > Global MIMO Configuration")

See also [Table 5-11](#).

Precoding Scheme ← Precoding

Indicates the precoding scheme.

"None" Precoding is disabled.

"Spatial Multiplexing/Tx Diversity/Beamforming (UE-spec.RS)"

For "General DL Settings > Antenna Ports > Global MIMO Configuration ≥ 2 Tx Antennas", indicates that precoding for spatial multiplexing, beamforming or transmit diversity is performed according to TS 36.211.

Remote command:

`[:SOURCE<hw>] :BB:EUTRa:DL:EMTC:ALLoc<ch0>:PRECoding:SCHEME`
on page 883

Transmission Scheme ← Precoding

For "Precoding Scheme = Beamforming (UE-spec.RS)", indicates the used transmission scheme.

See [Table 5-11](#).

Remote command:

`[:SOURCE<hw>] :BB:EUTRa:DL:EMTC:ALLoc<ch0>:PRECoding:TRScheme?`
on page 884

Number of Layers ← Precoding

Displays the number of layers for the selected allocation.

See also [Table 5-11](#).

Remote command:

`[:SOURCE<hw>] :BB:EUTRa:DL:EMTC:ALLoc<ch0>:PRECoding:NOLayers?`
on page 883

Codeword ← Precoding

Displays the number of the codeword and the total number of codewords used for the selected allocation.

Remote command:

`[:SOURCE<hw>] :BB:EUTRa:DL:EMTC:ALLoc<ch0>:CODWords?` on page 883

Cyclic Delay Diversity ← Precoding

If "Precoding Scheme = Spatial Multiplexing", sets the CDD for the selected allocation.

Remote command:

`[:SOURCE<hw>] :BB:EUTRa:DL:EMTC:ALLoc<ch0>:PRECoding:CCD`
on page 884

Codebook Index ← Precoding

If "Precoding Scheme = Spatial Multiplexing/Beamforming (UE-spec.RS)", sets the codebook index for the selected allocation.

Remote command:

`[:SOURCE<hw>] :BB:EUTRa:DL:EMTC:ALLoc<ch0>:PRECoding:CBIndex`
on page 884

Antenna Ports ← Precoding

For "Precoding Scheme = Beamforming (UE-spec.RS)", indicates the antenna ports for the current "Transmission Scheme".

The value is selected from the Tx Mode of the corresponding UE and the number of Tx antennas ("General DL Settings > Antenna Ports > Global MIMO Configuration").

See [Table 5-11](#).

Remote command:

```
[ :SOURCE<hw> ] :BB:EUTRa:DL:EMTC:ALLoc<ch0>:PRECoding:AP?
```

on page 885

Scrambling Identity n_SCID ← Precoding

For "Precoding Scheme = Beamforming (UE-spec.RS)", indicates the scrambling identity (as of [TS 36.211](#)).

Remote command:

```
[ :SOURCE<hw> ] :BB:EUTRa:DL:EMTC:ALLoc<ch0>:PRECoding:SCID?
```

on page 886

Antenna Port Mapping ← Precoding

For "Precoding Scheme = Beamforming (UE-spec.RS)", indicates the way that the logical antenna ports are mapped to the physical TX antennas.

Remote command:

```
[ :SOURCE<hw> ] :BB:EUTRa:DL:EMTC:ALLoc<ch0>:PRECoding:APM?
```

on page 886

Mapping Coordinates ← Precoding

For "Precoding Scheme = Beamforming (UE-spec.RS)", switches between the "Cartesian" and "Cylindrical" coordinates representation.

Remote command:

```
[ :SOURCE<hw> ] :BB:EUTRa:DL:EMTC:ALLoc<ch0>:PRECoding:DAFormat
```

on page 886

Mapping Table ← Precoding

Defines the mapping of the antenna ports (AP) to the physical antennas

Remote command:

```
[ :SOURCE<hw> ] :BB:EUTRa:DL:EMTC:ALLoc<ch0>:PRECoding:AP<dir0>:
BB<st0>:REAL? on page 886
[ :SOURCE<hw> ] :BB:EUTRa:DL:EMTC:ALLoc<ch0>:PRECoding:AP<dir0>:
BB<st0>:IMAGinary? on page 887
```

Scrambling

Comprises the scrambling settings.

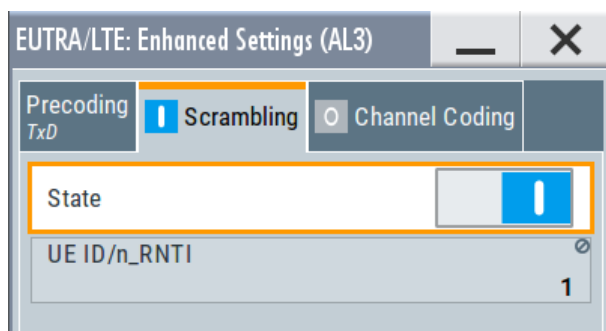
**Scrambling State** ← Scrambling

Enables scrambling.

Remote command:

`[:SOURCE<hw>] :BB:EUTRa:DL:EMTC:ALLoc<ch0>:SCRambling:STATe`
on page 887

UE ID/n_RNTI ← Scrambling

Indicates the user equipment identifier (n_RNTI) or UE ID of the user to which the PDSCH transmission is intended. The displayed "UE ID/n_RNTI" value is used to calculate the scrambling sequence.

Remote command:

`[:SOURCE<hw>] :BB:EUTRa:DL:EMTC:ALLoc<ch0>:SCRambling:UEID?`
on page 888

Channel Coding

Comprises the channel coding settings. Channel coding state is configurable. All other settings are configured automatically.

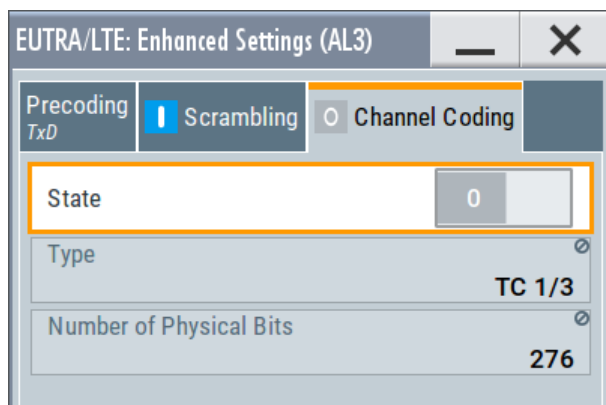
**Channel Coding State** ← Channel Coding

Enables channel coding.

Remote command:

`[:SOURCE<hw>] :BB:EUTRa:DL:EMTC:ALLoc<ch0>:CCODing:STATe`
on page 888

Type Channel Coding ← Channel Coding

Displays the used channel coding scheme and channel coding rate.

PBCH uses always tail biting convolution coding with code rate 1/3; PDSCH uses always turbo code with code rate 1/3.

Remote command:

n.a.

Number of Physical Bits ← Channel Coding

Indicates the calculated number of physical bits; resembles the information displayed with parameter [Phys. Bits](#).

Remote command:

`[:SOURCE<hw>] :BB:EUTRa:DL:EMTC:ALLoc<ch0>:PHYSbits?` on page 880

Transport Block Size I_{TBS} ← Channel Coding

Displays the resulting transport block size index.

Remote command:

`[:SOURCE<hw>] :BB:EUTRa:DL:EMTC:ALLoc<ch0>:CCODing:TBSI` on page 889

Transport Block Size/Payload (DL) ← Channel Coding

Displays the size of the transport block/payload in bits, calculated from the selected "Resource Assignment Field" and "Modulation and Coding Scheme".

Remote command:

`[:SOURCE<hw>] :BB:EUTRa:DL:EMTC:ALLoc<ch0>:CCODing:TBSize?`
on page 888

5.3.7.7 MPDCCH configuration

Access:

1. Select "Frame Configuration > General > User Configuration".
2. Select "User > 3GPP Release = CE Mode A/B > EPDCCH/MPDCCH > Config".

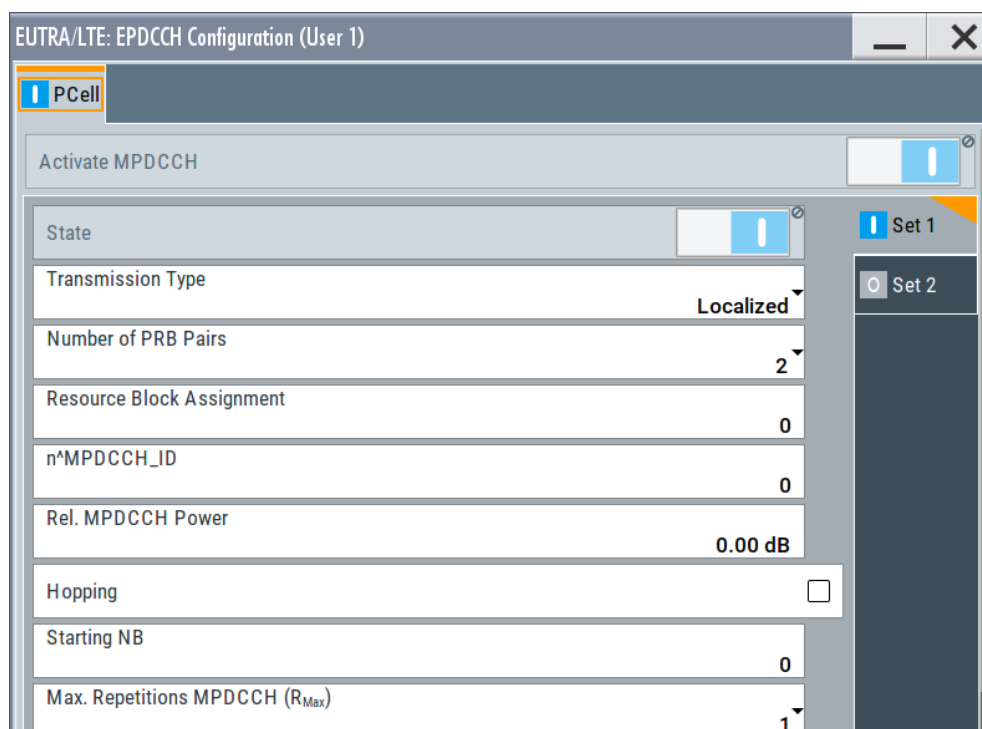

3. To activate the second state, select "Set 2 > State > On".
4. Select "Frame Configuration > eMTC > Allocation" to observe the MPDCCH allocation.

Settings:

See [Chapter 4.3.5, "EPDCCH configuration settings"](#), on page 147.

5.3.8 eMTC PUSCH settings

Access:

1. Select "General > General UL Settings > PUSCH > eMTC Parameters".

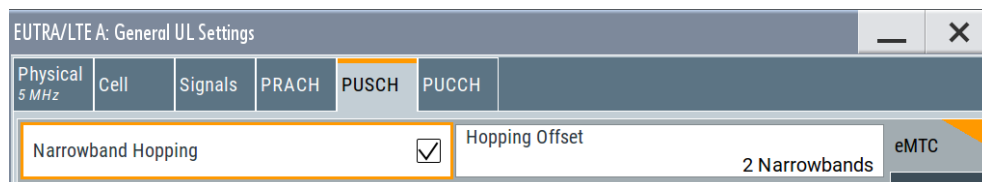

The dialog displays general PUSCH configuration parameters. To access the UE-specific PUSCH settings, follow the following instructions.

2. Select "Frame Configuration > UE x > 3GPP Release" = "eMTC".
3. To access the settings of the individual UE, click the "UE x" block.

4. Select "UE x > PUSCH".

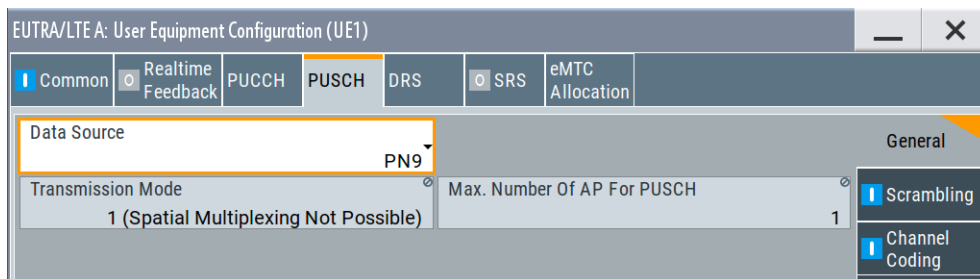

You can enable PUSCH scrambling and channel coding and multiplexing.

The provided settings are the same as for LTE, except that eMTC UEs do not support MIMO and the rank indication (RI) concept.

The "Transmission Mode = TM 1" and "Max. Number of AP for PUSCH = 1" are fixed.

5. To configure the **PUSCH transmission per UE**, select "Frame Configuration > UE x > eMTC Allocation".

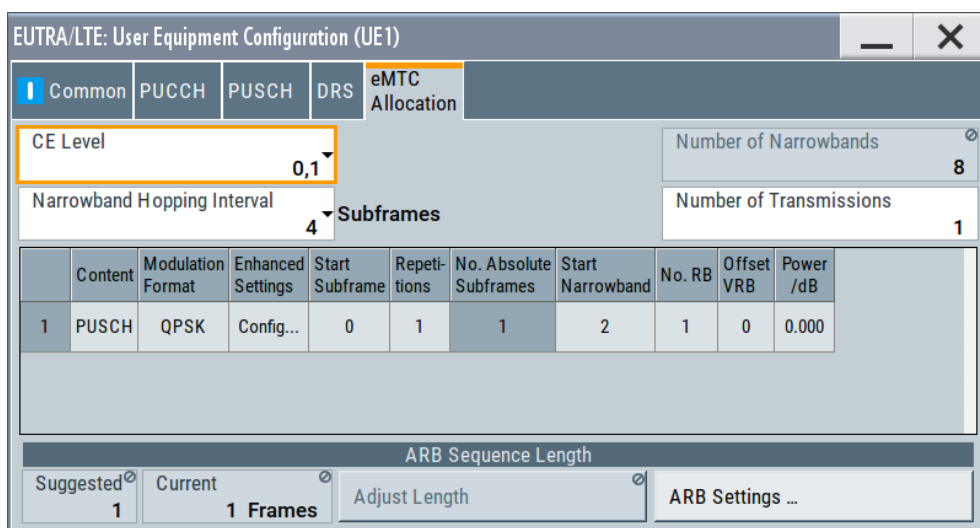

The eMTC allocation is individual per UE, in terms of used CE level, frequency hopping and number of transmissions.

There can be up to 20 PUSCH or PUCCH transmissions per UE, each of them using different format and occupying different resources in the time and in the frequency domain.

6. In the "eMTC Allocation" table, select "Transmission # > Content = PUSCH > Enhanced Settings > Config" to configure the channel coding and multiplexing of an eMTC allocation.
See [Chapter 5.3.8.3, "eMTC PUSCH channel coding and multiplexing settings"](#), on page 466.
7. To observe the PUSCH allocations, select "EUTRA/LTE > Frame Configuration > Time Plan".

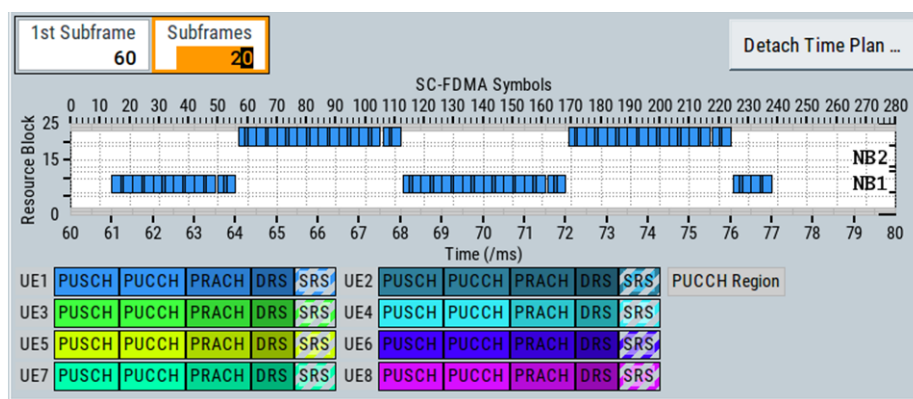

5.3.8.1 Cell-specific eMTC PUSCH settings

Access: see [Chapter 5.3.8, "eMTC PUSCH settings"](#), on page 458.

[Narrowband Hopping](#)..... 460
[Hopping Offset](#)..... 460

Narrowband Hopping

Enables narrowband hopping so that PUSCH allocations can change the used narrowband.

PUSCH hopping pattern is individual per UE. The number of subframes the PUSCH allocation remains in the same NB is defined with the UE-specific parameter [Narrowband Hopping Interval](#).

If hopping is disabled, the PUSCH repetitions are located in the same resource block at the same narrowband.

Remote command:

```
[ :SOURCE<hw> ] :BB:EUTRa:UL:PUSCh:NHOPping on page 895
```

Hopping Offset

If "Narrowband Hopping > On", sets the value of the cell-specific higher-level parameter f_{hop}^{NB} required to calculate the PUSCH frequency hopping pattern. The hopping offset is difference in narrowbands between the narrowband number of the current and the subsequent narrowband.

The max possible hopping offset depends on the number of available narrowbands (see [Number of eMTC Narrowbands](#)).

Use the "Time Plan" to visualize the PUSCH allocation.

For example, see [Example"PUSCH hopping"](#) on page 343.

Remote command:

```
[ :SOURCE<hw> ] :BB:EUTRa:UL:PUSCh:NHOFfset on page 895
```

5.3.8.2 UE-specific eMTC PUSCH transmissions settings

Access: see [Chapter 5.3.8, "eMTC PUSCH settings"](#), on page 458.

The eMTC allocation configuration is individual per UE and is defined **per coverage extension level CE**. eMTC allocation is composed of up to 20 PUCCH or PUSCH transmissions, each one described in a row in the eMTC allocation table.

Settings:

CE Level.....	461
Number of eMTC Narrowbands.....	461
Number of eMTC Widebands.....	462
Narrowband Hopping Interval.....	462
Number of Transmissions.....	462
Content.....	462
Modulation/Format.....	462
Enhanced Setting > Config.....	463
Start Subframe.....	463
Repetitions.....	463
No. Absolute Subframes.....	464
Start Narrowband.....	464
No. RB.....	464
Offset VRB.....	465
Start Wideband.....	465
No. RB.....	465
Offset VRB.....	465
Power, dB.....	465
ARB Sequence Length.....	465
L Suggested.....	466
L Current.....	466
L Adjust Length.....	466
L ARB Settings.....	466

CE Level

Sets the coverage extension level (CE).

3GPP defines two CE modes for eMTC, CEModeA and CEModeB:

- "CE Level = 0, 1" corresponds to CEModeA
This mode uses small number of PUSCH or PUCCH repetitions.
- "CE Level = 2, 3" corresponds to CEModeB
This mode enables large number of PUSCH or PUCCH repetitions.

Remote command:

[:SOURce<hw>] :BB:EUTRa:UL:UE<st>:EMTC:CELevel on page 920

Number of eMTC Narrowbands

Option: R&S SMM-K115

This parameter is **dedicated to eMTC** and available if "Mode > eMTC/NB-IoT or LTE/eMTC/NB-IoT" is selected.

It indicates the number of eMTC narrowbands N_{NB} available within the selected channel bandwidth.

The value is calculated as follows:

"Number of Narrowbands" = "Number of Resource Blocks" / 6

For more information, see "Narrowbands" on page 332.

Remote command:

[:SOURce<hw>] :BB:EUTRa:UL:EMTC:NNBands? on page 893

Number of eMTC Widebands

Option: R&S SMM-K143

This parameter is **dedicated to eMTC** and available if "Mode > eMTC/NB-IoT or LTE/ eMTC/NB-IoT" and **Wideband Config** > "On" is selected.

It indicates the number of eMTC widebands N_{WB} available within the selected channel bandwidth.

The value is calculated as follows:

"Number of Widebands" = **Number of eMTC Narrowbands** / 4

For more information, see "Widebands" on page 333.

Remote command:

[:SOURce<hw>] :BB:EUTRa:UL:EMTC:NWBands? on page 894

Narrowband Hopping Interval

Sets the higher-level parameter N_{ch}^{NB} .

It defines the number of consecutive subframes the hopping pattern remains in the same narrowband.

Table 5-45: Hopping intervals N_{ch}^{NB} per CE level and duplexing mode

"CE Level"	"Duplexing > FDD"	"Duplexing > TDD"
0, 1	1, 2, 4, 8	1, 5, 10, 20
2, 3	2, 4, 8, 16	5, 10, 20, 40

Remote command:

[:SOURce<hw>] :BB:EUTRa:UL:UE<st>:EMTC:HOPP on page 920

Number of Transmissions

Enables up to 20 individual PUSCH and PUCCH transmissions, where each transmission is configured in a separate row in the eMTC allocation table.

Use the "Time Plan" to visualize the eMTC allocation.

Remote command:

[:SOURce<hw>] :BB:EUTRa:UL:UE<st>:EMTC:NTRansmiss on page 920

Content

Selects the channel type and defines whether PUSCH or PUCCH is transmitted.

Remote command:

[:SOURce<hw>] :BB:EUTRa:UL:UE<st>:EMTC:TRANs<ch>:CONTent on page 920

Modulation/Format

For PUSCH transmission, this parameter sets the used modulation scheme (QPSK, 16QAM or 64QAM).

For PUCCH transmission, this parameter sets the PUCCH format.

Table 5-46: PUCCH formats depending on the CE mode and duplexing mode

"CE Level"	"Duplexing > FDD"	"Duplexing > TDD"
0, 1	1, 1a, 2, 2a, 2b	1, 1a, 1b, 2, 2a, 2b
2, 3	1, 1a	1, 1a

Remote command:

`[:SOURCE<hw>] :BB:EUTRa:UL:UE<st>:EMTC:TRANs<ch>:MODulation`
on page 921

`[:SOURCE<hw>] :BB:EUTRa:UL:UE<st>:EMTC:TRANs<ch>:FORMat` on page 921

Enhanced Setting > Config

Access dialogs with further channel coding and multiplexing settings.

The displayed settings depend on the transmission content, see:

- [Chapter 5.3.8.3, "eMTC PUSCH channel coding and multiplexing settings"](#), on page 466
- [Chapter 5.3.9.3, "eMTC PUCCH channel coding and multiplexing settings"](#), on page 474

Start Subframe

Sets the subframe number in that the PUSCH/PUCCH allocation is scheduled for the first time.

The following applies for each subsequent allocation:

$$\text{Start_SF}_{\text{PUSCH},i+1} = \text{Start_SF}_{\text{PUSCH},i} + n_{\text{Rep}}^{\text{PUSCH}} + n_{\text{invalid_SF}} + 1$$

Where:

- $n_{\text{invalidSF}}$ is the number of SF that is set as not valid for eMTC in the "General UL Settings" dialog (see ["Valid Subframes"](#) on page 232).
- $n_{\text{Rep}}^{\text{PUSCH}}$ is set with the parameter [Repetitions](#).

Example:

- Allocation#1
PUSCH with $\text{Start_SF} = 0$, $n_{\text{Rep}}^{\text{PUSCH}} = 8$ and $n_{\text{invalid_SF}} = 2$
- The first possible "Start Subframe" for allocation#2
 $\text{Start_SF} = 0 + 8 + 2 + 1 = 11$

Note: If more than one UE are configured, the UEs have to use different "Start Subframe".

Otherwise, a conflict is indicated in the "UL Frame Configuration > Subframe > Allocation Table" dialog.

Remote command:

`[:SOURCE<hw>] :BB:EUTRa:UL:UE<st>:EMTC:TRANs<ch>:STSFrame`
on page 921

Repetitions

Sets how many times a transmission is repeated.

Table 5-47: Possible number of repetitions (n_{Rep}^{PUSCH} and n_{Rep}^{PUCCH}) depending on the CE mode and the channel type

"CE Level"	PUSCH	PUCCH
0, 1	1, 2, 4, 8, 16, 32 Option: R&S SMM-K143 12, 24	1, 2, 4, 8
2, 3	1, 4, 8, 16, 32, 64, 128, 192, 256, 384, 512, 768, 1024, 1536, 2048	4, 8, 16, 32 Option: R&S SMM-K143 64, 128

Remote command:

`[:SOURCE<hw>] :BB:EUTRa:UL:UE<st>:EMTC:TRANS<ch>:REPetitions`
on page 922

No. Absolute Subframes

Number of absolute subframes (n_{abs_SF}) is calculated as follows:

$$n_{abs_SF} = n_{Rep}^{PUSCH} + n_{invalid_SF}$$

Where:

- $n_{invalidSF}$ is the number of SF that is set as not valid for eMTC in the "General UL Settings" dialog (see "Valid Subframes" on page 232).
- n_{Rep}^{PUSCH} is set with the parameter [Repetitions](#).

Remote command:

`[:SOURCE<hw>] :BB:EUTRa:UL:UE<st>:EMTC:TRANS<ch>:ASFFrame?`
on page 921

Start Narrowband

Sets the first NB used for the PSUCH/PUCCH transmission.

Remote command:

`[:SOURCE<hw>] :BB:EUTRa:UL:UE<st>:EMTC:TRANS<ch>:STNband`
on page 922

No. RB

Sets the number of used resource blocks (RB) within one narrowband.

According to [TS 36.211](#), a UE can allocate between one RB and the whole narrowband, where:

- For CEModeA UE, the used number of RBs is configurable value between 1 and 6 RBs
- For CEModeB UE, the allocations are predefined, see [Table 5-48](#).

Table 5-48: Resource blocks allocation for UE configured in CEModeB [TS 36.213]

Value of resource allocation field	Allocated resource blocks
000	0
001	1
010	2
110	3

Value of resource allocation field	Allocated resource blocks
100	4
101	5
110	0 and 1
111	2 and 3

Remote command:

`[:SOURCE<hw>] :BB:EUTRa:UL:UE<st>:EMTC:TRANs<ch>:NRBLocks`
on page 922

Offset VRB

For allocations that span less than 6 RB, this parameter shifts the selected **No. RB** within the NB.

Remote command:

`[:SOURCE<hw>] :BB:EUTRa:UL:UE<st>:EMTC:TRANs<ch>:RBOffset`
on page 922

Start Wideband

Option: R&S SMM-K143

Sets the first wideband used for the PSUCH/PUCCH transmission.

Remote command:

`[:SOURCE<hw>] :BB:EUTRa:UL:UE<st>:EMTC:TRANs<ch>:STWBand`
on page 923

No. RB

Option: R&S SMM-K143

Sets the number of used resource blocks (RB) within one wideband.

Remote command:

`[:SOURCE<hw>] :BB:EUTRa:UL:UE<st>:EMTC:TRANs<ch>:WRBLocks`
on page 923

Offset VRB

Option: R&S SMM-K143

Shifts the selected **No. RB** within the wideband.

Remote command:

`[:SOURCE<hw>] :BB:EUTRa:UL:UE<st>:EMTC:TRANs<ch>:WBRBoffset`
on page 923

Power, dB

Sets the power of the eMTC PUSCH and PUCCH transmission (P_{PUSCH} or P_{PUCCH}).

Remote command:

`[:SOURCE<hw>] :BB:EUTRa:UL:UE<st>:EMTC:TRANs<ch>:POWER` on page 924

ARB Sequence Length

Comprises setting for automatic adjustment of the ARB sequence length.

Suggested ← ARB Sequence Length

- NB-LoT allocations:
Indicates the ARB sequence length that is required for the selected NPUSCH transmissions.
- eMTC allocations:
Number of frames required for the one complete transmission.
The value is calculated as the sum of the Start_SF and $n_{\text{abs_SF}}$.

Use the "Adjust Length" function to apply the suggested value.

Remote command:

[:SOURce<hw>] :BB:EUTRa:UL:UE<st>:NIOT:ARB:SUGGested? on page 907

[:SOURce<hw>] :BB:EUTRa:UL:UE<st>:EMTC:ARB:SUGGested? on page 924

Current ← ARB Sequence Length

Indicates the current ARB sequence length.

Adjust Length ← ARB Sequence Length

Sets the ARB sequence length to the suggested value.

ARB Settings ← ARB Sequence Length

Opens the ARB dialog.

5.3.8.3 eMTC PUSCH channel coding and multiplexing settings

Access: see [Chapter 5.3.8, "eMTC PUSCH settings"](#), on page 458.

In this dialog you can:

- Set the cyclic shift used by the demodulation reference signal (DMRS)
- Adjust the parameters for channel coding of the control information (HARQ and CQI)
- Configure the multiplexing of the control information with the data transmission over the uplink shared channel (UL-SCH)

The eMTC PUSCH configuration reuses the LTE concept, expect:

- In eMTC, PUSCH frequency hopping is configured in a different way.
- eMTC does not support rank indication (RI)
- eMTC uses different parameter "Starting Redundancy Version Index (rv_idx)".

Settings:

Common.....	467
DMRS.....	467
L Cyclic Shift Filed.....	467
L n(2)_DMRS,0 (Layer 0).....	467
HARQ ACK.....	468
L ACK/NACK Mode.....	468
L Number of A/N Bits.....	468
L ACK/NACK Pattern.....	468
L Number of Coded A/N Bits.....	469
Channel Quality Indication CQI.....	469

- L Number of CQI Bits.....469
- L CQI Pattern.....469
- L Number of Coded CQI Bits.....469
- Enhanced Setting > UL-SCH.....469
 - L Total Number of Physical Bits.....470
 - L Number of Coded UL-SCH Bits.....470
 - L Transport Block Size/Payload.....470
 - L Starting Redundancy Version Index (rv_idx).....470

Common

The "Common" dialog indicates the type of the selected channel.

DMRS

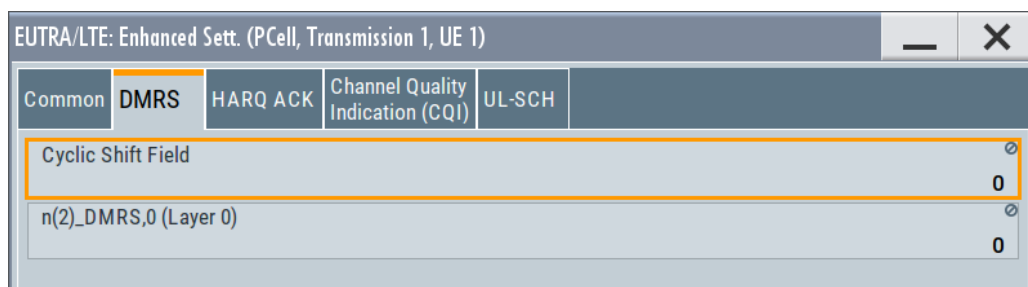

The provided settings are identical to the LTE demodulation reference signal (DMRS) settings.

Cyclic Shift Filed ← DMRS

Sets the cyclic shift field in the uplink-related DCI formats.

Cyclic shifts are used to separate the DMRS signals of different users in the time domain.

Remote command:

```
[ :SOURce<hw> ] :BB:EUTRa:UL:UE<st>:EMTC:TRANs<ch>:DRS:CYCShift?
```

on page 924

n(2)_DMRS,0 (Layer 0) ← DMRS

Displays the part of the demodulation reference signal (DMRS) index $n^{(2)}_{DMRS,0}$ for layer 0.

"Cyclic Shift Field"	n(2)_DMRS, 0
000	0
001	6
010	3
011	4
100	2
101	8

"Cyclic Shift Field"	n(2)_DMRS, 0
110	10
111	9

The DMRS index is part of the uplink scheduling assignment and valid for one UE in the subframe. This index applies when multiple shifts within a cell are used and is used by the calculation of the DMRS sequence.

Remote command:

[:SOURce<hw>] :BB:EUTRa:UL:UE<st>:EMTC:TRANs<ch>:NDMRs? on page 924

HARQ ACK

Access: "UEx > PUSCH > Channel Coding and Multiplexing > State > On" and "Mode = UCI only/UCI + UL-SCH".

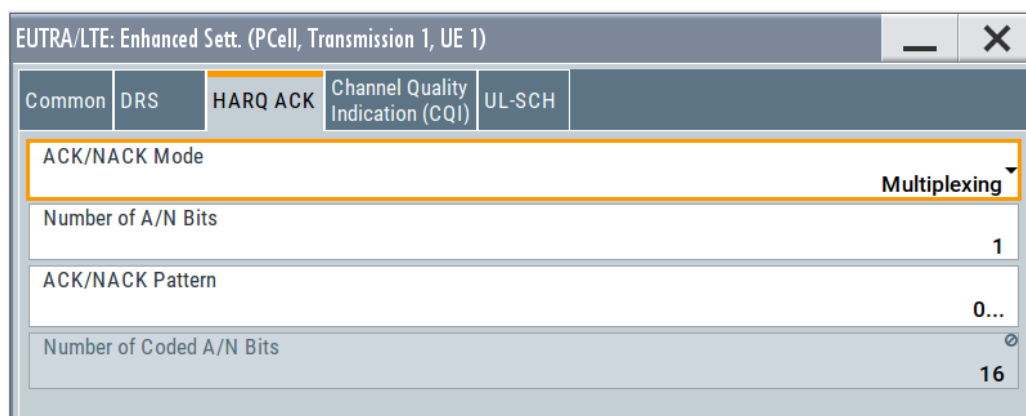

The provided settings are identical to the LTE HARQ ACK settings.

ACK/NACK Mode ← HARQ ACK

Sets the ACK/NACK mode.

Remote command:

[:SOURce<hw>] :BB:EUTRa:UL:UE<st>:EMTC:TRANs<ch>:HARQ:MODE

on page 926

Number of A/N Bits ← HARQ ACK

Sets the number of ACK/NACK bits.

Remote command:

[:SOURce<hw>] :BB:EUTRa:UL:UE<st>:EMTC:TRANs<ch>:HARQ:BITS

on page 927

ACK/NACK Pattern ← HARQ ACK

Sets the ACK/NACK bit pattern.

A "1" indicates an ACK, a "0" - a NACK.

Remote command:

[:SOURce<hw>] :BB:EUTRa:UL:UE<st>:EMTC:TRANs<ch>:HARQ:PATtern

on page 927

Number of Coded A/N Bits ← HARQ ACK

Displays the number of coded ACK/NACK bits.

Remote command:

`[:SOURCE<hw>] :BB:EUTRa:UL:UE<st>:EMTC:TRANs<ch>:HARQ:CBITs?`
on page 927

Channel Quality Indication CQI

Access:

- "UEX > PUSCH > Channel Coding and Multiplexing > State > On"
- "Mode = UCI only/UCI + UL-SCH".

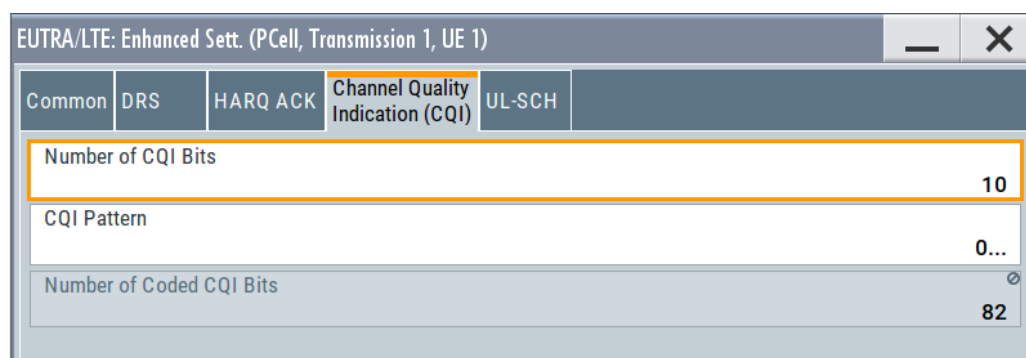

The provided settings are identical to the LTE CQI settings.

Number of CQI Bits ← Channel Quality Indication CQI

Sets the number of CQI bits before channel coding.

Remote command:

`[:SOURCE<hw>] :BB:EUTRa:UL:UE<st>:EMTC:TRANs<ch>:PUSCh:CQI:BITS`
on page 925

CQI Pattern ← Channel Quality Indication CQI

Sets the CQI pattern for the PUSCH.

Remote command:

`[:SOURCE<hw>] :BB:EUTRa:UL:UE<st>:EMTC:TRANs<ch>:PUSCh:CQI:PATtern`
on page 925

Number of Coded CQI Bits ← Channel Quality Indication CQI

Displays the number of coded CQI bits.

Remote command:

`[:SOURCE<hw>] :BB:EUTRa:UL:UE<st>:EMTC:TRANs<ch>:PUSCh:CQI:CBITs?`
on page 925

Enhanced Setting > UL-SCH

Access:

- "UEX > PUSCH > Channel Coding and Multiplexing > State > On"
- "Mode = UL-SCH only/UCI + UL-SCH".

The eMTC PUSCH configuration reuses the LTE concept.

Common	DRS	HARQ ACK	Channel Quality Indication (CQI)	UL-SCH
UL-SCH Codeword 1				
Total Number Of Physical Bits				288
Number Of Coded UL-SCH Bits				196
Transport Block Size/Payload				16
Starting Redundancy Version Index (rv_idx)				0

The same settings and interdependency apply expect the used "Starting Redundancy Version Index (rv_idx)".

Total Number of Physical Bits ← Enhanced Setting > UL-SCH

Displays the size of the eMTC allocation in bits.

Remote command:

```
[ :SOURCE<hw> ] :BB:EUTRa:UL:UE<st>:EMTC:TRANs<ch>:PHYSbits?  
on page 928
```

Number of Coded UL-SCH Bits ← Enhanced Setting > UL-SCH

Displays the number of physical bits used for UL-SCH transmission.

Remote command:

```
[ :SOURCE<hw> ] :BB:EUTRa:UL:UE<st>:EMTC:TRANs<ch>:ULSch:BITS?  
on page 926
```

Transport Block Size/Payload ← Enhanced Setting > UL-SCH

Sets the size of the transport block.

Remote command:

```
[ :SOURCE<hw> ] :BB:EUTRa:UL:UE<st>:EMTC:TRANs<ch>:CCODing:TBSize  
on page 926
```

Starting Redundancy Version Index (rv_idx) ← Enhanced Setting > UL-SCH

Sets the redundancy version index.

Remote command:

```
[ :SOURCE<hw> ] :BB:EUTRa:UL:UE<st>:EMTC:TRANs<ch>:CCODing:RVIndex  
on page 928
```

5.3.9 eMTC PUCCH settings

Access:

1. Select "General > General UL Settings > PUCCH" to access the **cell-specific PUCCH** settings.

eMTC reuses the LTE PUCCH configuration.

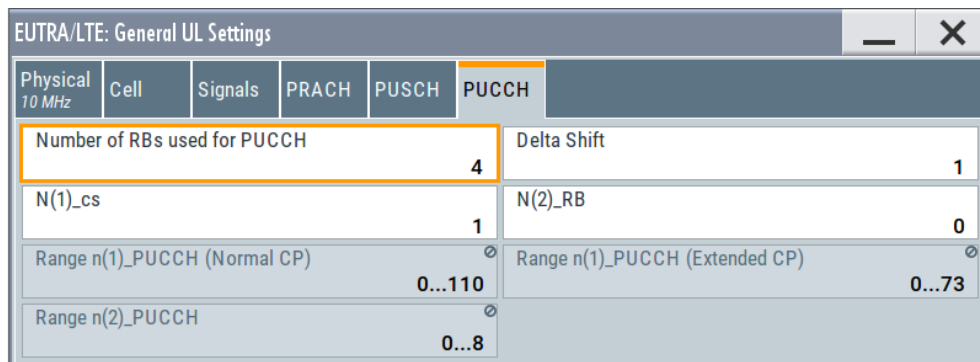

Physical 10 MHz	Cell	Signals	PRACH	PUSCH	PUCCH		
Number of RBs used for PUCCH					4	Delta Shift	1
N(1)_cs					1	N(2)_RB	0
Range n(1)_PUCCH (Normal CP)					0...110	Range n(1)_PUCCH (Extended CP)	0...73
Range n(2)_PUCCH					0...8		

To access the **UE-specific PUCCH settings**, follow the following instructions.

2. Select "Frame Configuration > UE" > "**3GPP Release = eMTC**".
3. Select "UE x > PUCCH".

eMTC reuses the UE-specific PUCCH configuration, except that eMTC UEs do not support MIMO and PUCCH format 3.

Hence "Number of AP for PUCCH Formats = 1".

4. To configure the **PUCCH transmission per UE**, select "Frame Configuration > UE x" > "**eMTC Allocation**".

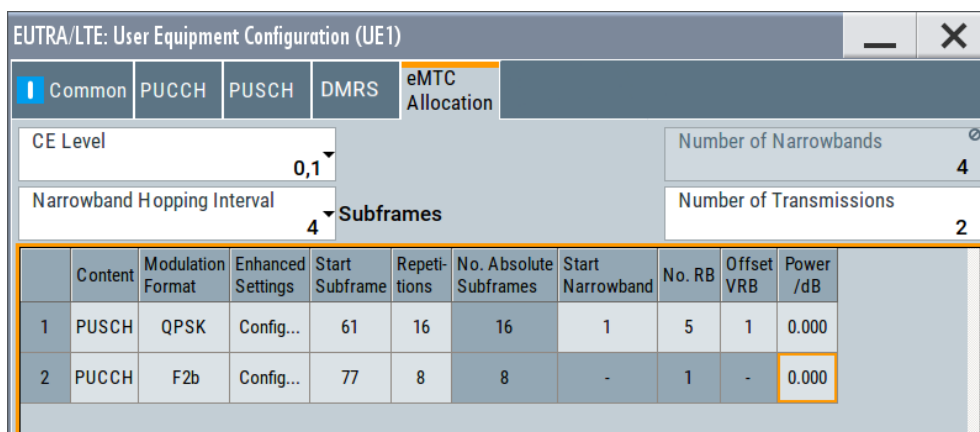

EUTRA/LTE: User Equipment Configuration (UE1)											
Common PUCCH PUSCH DMRS eMTC Allocation											
CE Level								Number of Narrowbands			
0,1								4			
Narrowband Hopping Interval								Number of Transmissions			
4 Subframes								2			
	Content	Modulation Format	Enhanced Settings	Start Subframe	Repetitions	No. Absolute Subframes	Start Narrowband	No. RB	Offset VRB	Power /dB	
1	PUSCH	QPSK	Config...	61	16	16	1	5	1	0.000	
2	PUCCH	F2b	Config...	77	8	8	-	1	-	0.000	

The eMTC allocation is individual per UE, in terms of used CE level, frequency hopping and number of transmissions. There can be up to 10 PUSCH or PUCCH transmissions per UE, each of them using different format and occupying different resources in the time and in the frequency domain.

For settings description, see [Chapter 5.3.8.2, "UE-specific eMTC PUSCH transmissions settings"](#), on page 460.

5. In the "eMTC Allocation" table, select "Transmission # > Content = PUCCH > Enhanced Settings > Config" to configure the **channel coding and multiplexing of an eMTC allocation**.
See [Chapter 5.3.9.3, "eMTC PUCCH channel coding and multiplexing settings"](#), on page 474.

- To observe the PUCCH allocations, select "EUTRA/LTE > Frame Configuration > Time Plan".

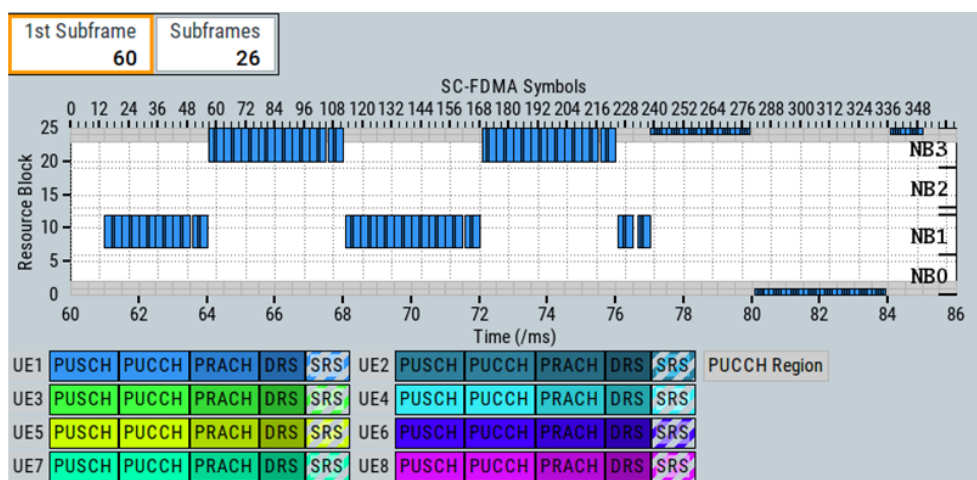

5.3.9.1 Cell-specific eMTC PUCCH settings

Access: see [Chapter 5.3.9, "eMTC PUCCH settings"](#), on page 470.

Settings:

Number of RBs used for PUCCH.....	472
Delta Shift.....	473
N(1)_cs.....	473
N(2)_RB.....	474
Range n(1)_PUCCH (Normal/Extended CP).....	474
Range n(2)_PUCCH.....	474

Number of RBs used for PUCCH

Sets the PUCCH region in terms of reserved resource blocks, at the edges of the channel bandwidth (see [Figure 2-18](#)).

The PUCCH region is displayed on the time plan.

Example:

- "Physical > Channel Bandwidth = 3 MHz"
- "General UL Settings > PUCCH > Number of RBs used for PUCCH = 3"
- "UL Frame Configuration > PUCCH > Format = 2a" and "PUCCH State > On"

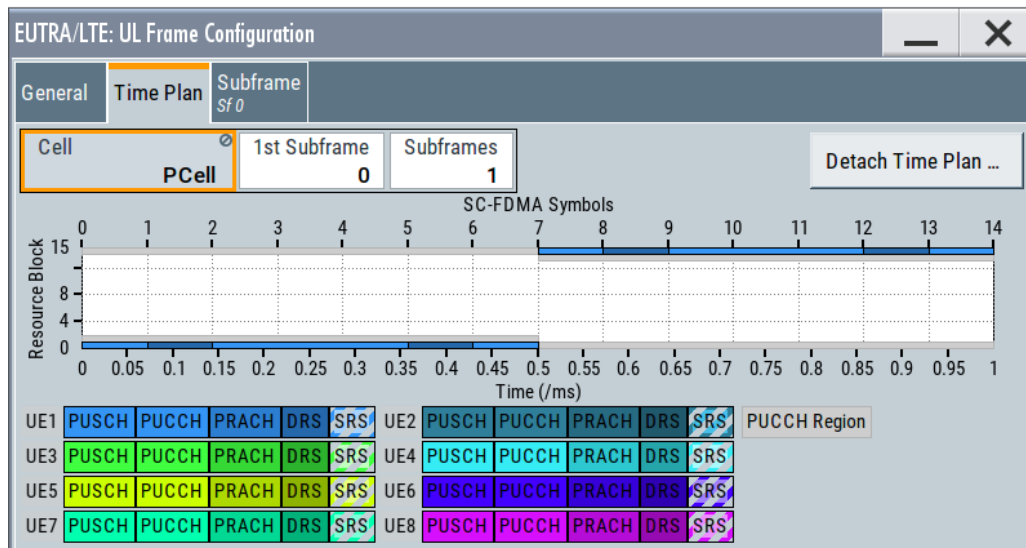

Figure 5-21: Example: Representation of subframe with PUCCH region with three reserved resource blocks on the time plan

Remote command:

`[:SOURCE<hw>] :BB:EUTRa:UL:PUCCh:NORB` on page 601

Delta Shift

Sets the delta shift parameter, i.e. the cyclic shift difference between two adjacent PUCCH resource indices with the same orthogonal cover sequence (OC).

The delta shift determines the number of available sequences in a resource block that can be used for PUCCH formats 1/1a/1b (see also [Table 2-5](#)).

Remote command:

`[:SOURCE<hw>] :BB:EUTRa:UL:PUCCh:DESHift` on page 602

N(1)_cs

Sets the number of cyclic shifts used for PUCCH format 1/1a/1b in a resource block used for a combination of the formats 1/1a/1b and 2/2a/2b.

Only one resource block per slot can support a combination of the PUCCH formats 1/1a/1b and 2/2a/2b.

The number of cyclic shifts available for PUCCH format 2/2a/2b $N(2)_{cs}$ in a block with combination of PUCCH formats is calculated as follows:

$$N(2)_{cs} = 12 - N(1)_{cs} - 2$$

Remote command:

`[:SOURCE<hw>] :BB:EUTRa:UL:PUCCh:N1CS` on page 602

N(2)_RB

Sets bandwidth in terms of resource blocks that are reserved for PUCCH formats 2/2a/2b transmission in each subframe.

There can be only one resource block per slot that supports a combination of the PUCCH formats 1/1a/1b and 2/2a/2b. Hence, the number of RBs per slot available for PUCCH format 1/1a/1b is determinate by "N(2)_RB".

Remote command:

[:SOURCE<hw>] :BB:EUTRa:UL:PUCCh:N2RB on page 602

Range n(1)_PUCCH (Normal/Extended CP)

Displays the range of the possible PUCCH format 1/1a/1b transmissions from different UEs in one subframe and per cyclic prefix.

Insufficient ranges are displayed as '-!'.
 The parameter "Range n(1)_PUCCH (Normal CP)" determines the value range of the index "n_PUCCH" for PUCCH format 1/1a/1b.

See [n_PUCCH](#)

Remote command:

[:SOURCE<hw>] :BB:EUTRa:UL:PUCCh:N1NMax? on page 603

[:SOURCE<hw>] :BB:EUTRa:UL:PUCCh:N1EMax? on page 603

Range n(2)_PUCCH

Displays the range of possible number of PUCCH format 2/2a/2b transmissions from different UEs in one subframe.

Insufficient ranges are displayed as '-!'.
 Remote command:

Remote command:

[:SOURCE<hw>] :BB:EUTRa:UL:PUCCh:N2Max? on page 603

5.3.9.2 UE-specific eMTC PUCCH settings

Access: see [Chapter 5.3.9, "eMTC PUCCH settings"](#), on page 470.

Number of Antenna Ports for PUCCH per PUCCH Format

For [3GPP Release](#) = "LTE-Advanced" UEs, sets the number of antenna ports used for every PUCCH format transmission.

eMTC UEs ("3GPP Release = eMTC") support transmission with one antenna port.

Remote command:

[:SOURCE<hw>] :BB:EUTRa:UL:UE<st>:PUCCh:F1Naport on page 762

[:SOURCE<hw>] :BB:EUTRa:UL:UE<st>:PUCCh:F2Naport on page 762

[:SOURCE<hw>] :BB:EUTRa:UL:UE<st>:PUCCh:F3Naport on page 762

[:SOURCE<hw>] :BB:EUTRa:UL:UE<st>:PUCCh:F4Naport? on page 761

[:SOURCE<hw>] :BB:EUTRa:UL:UE<st>:PUCCh:F5Naport? on page 761

5.3.9.3 eMTC PUCCH channel coding and multiplexing settings

Access: see [Chapter 5.3.9, "eMTC PUCCH settings"](#), on page 470.

The eMTC PUCCH configuration reuses the LTE concept.

Settings:

- Common.....475
 - L Format.....475
 - L Number of Used Antenna Port.....475
 - L n_PUCCH Antenna Port 100.....476
- Channel Coding and Multiplexing.....476
 - L A/N Pattern.....476
 - L Number of CQI Bits.....476
 - L CQI Pattern.....476
 - L Number of Coded CQI Bits.....476

Common

The "Common" settings dialog indicates the type and format of the selected channel.

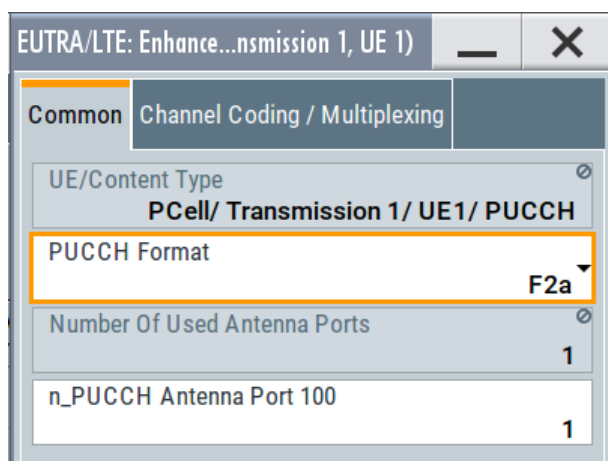

The "UE/Content" indication resembles related information from the "eMTC Allocation" table.

Format ← Common

For PUCCH transmission, this parameter sets the PUCCH format.

Table 5-49: PUCCH formats depending on the CE mode and duplexing mode

"CE Level"	"Duplexing > FDD"	"Duplexing > TDD"
0, 1	1, 1a, 2, 2a, 2b	1, 1a, 1b, 2, 2a, 2b
2, 3	1, 1a	1, 1a

Remote command:

[:SOURCE<hw>] :BB:EUTRa:UL:UE<st>:EMTC:TRANs<ch>:FORMat on page 921

Number of Used Antenna Port ← Common

Indicates that one antenna port is used.

Remote command:

[:SOURCE<hw>] :BB:EUTRa:UL:UE<st>:EMTC:TRANs<ch>:NAPused? on page 926

n_PUCCH Antenna Port 100 ← Common

Sets the PUCCH resource index.

Remote command:

`[:SOURCE<hw>] :BB:EUTRa:UL:UE<st>:EMTC:TRANs<ch>:NPUCCh` on page 927

Channel Coding and Multiplexing

Access: "UEX > eMTC Allocation > PUCCH > Format = F2b".

The provided settings are identical to the LTE settings.

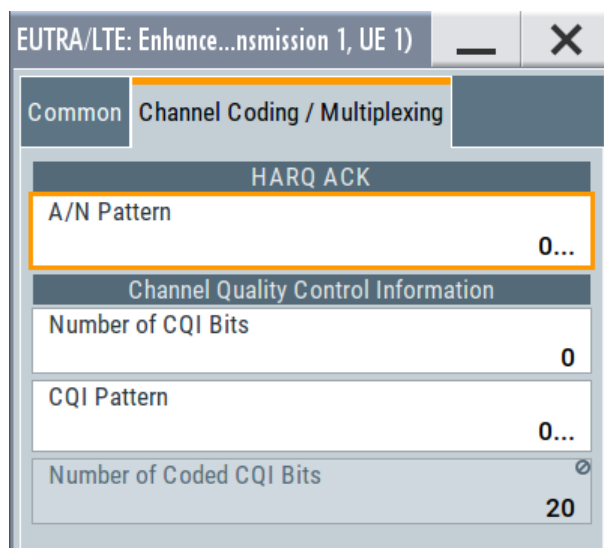
**A/N Pattern ← Channel Coding and Multiplexing**

Sets the PUCCH ACK/NACK pattern.

A "1" indicates an ACK, a "0" - a NACK.

Remote command:

`[:SOURCE<hw>] :BB:EUTRa:UL:UE<st>:EMTC:TRANs<ch>:PUCCh:HARQ: PATTeRn` on page 928

Number of CQI Bits ← Channel Coding and Multiplexing

Sets the number of CQI bits before channel coding.

Remote command:

`[:SOURCE<hw>] :BB:EUTRa:UL:UE<st>:EMTC:TRANs<ch>:PUCCh:CQI:BITS` on page 929

CQI Pattern ← Channel Coding and Multiplexing

Sets the CQI pattern for the PUCCH.

Remote command:

`[:SOURCE<hw>] :BB:EUTRa:UL:UE<st>:EMTC:TRANs<ch>:PUCCh:CQI: PATTeRn` on page 929

Number of Coded CQI Bits ← Channel Coding and Multiplexing

Displays the number of coded CQI bits.

The number of coded CQI bits for PUCCH is always 20.

Remote command:

[:SOURCE<hw>] :BB:EUTRa:UL:UE<st>:EMTC:TRANs<ch>:PUCCh:CQI:CBITs?
on page 929

5.3.10 eMTC PRACH settings

Access:

1. Select "General > General UL Settings > PRACH".
2. Select the "eMTC" side tab.

The dialog comprises the parameters to define the PRACH per coverage extension level (CE level).

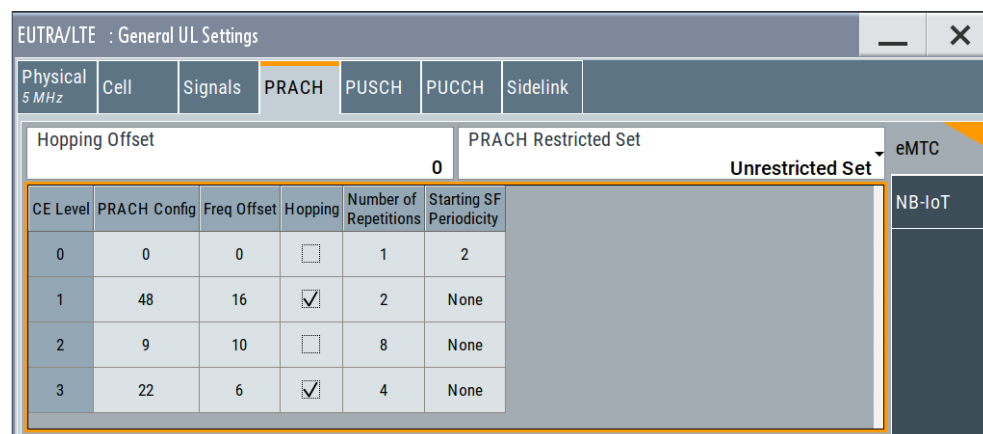

The group of LTE parameters has no effect on the eMTC PRACH configuration.

3. To allocate the NPRACH for a specific UE, use the following parameters:
 - a) Select "UL Frame Configuration > UE1 > 3GPP Release = eMTC".
 - b) Select "UE1 > Settings > Common > Mode = PRACH".
 - c) Select "PRACH".

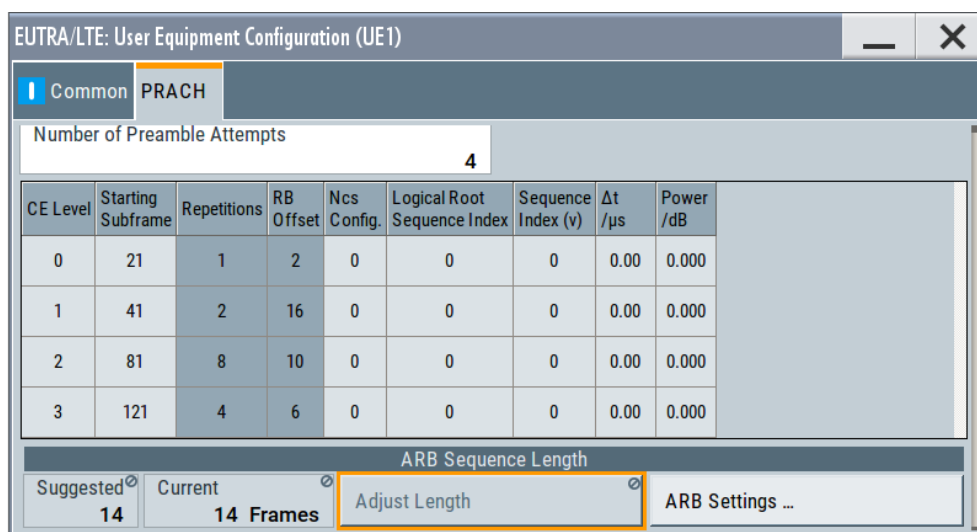

You can change the number of preamble attempts, select one of the PRACH configurations per attempt and PRACH allocation.

For description of the related settings, see "eMTC PRACH allocation per UE" on page 480.

4. If necessary, use the "Adjust Length" function to enable larger number of frames automatically so that the PRACH frequency hopping pattern is completed.
5. Open the "Time Plan" to visualize the PRACH allocation:
 - a) Select "UL Frame Configuration > Time Plan".
 - b) Configure the subframes to be displayed.

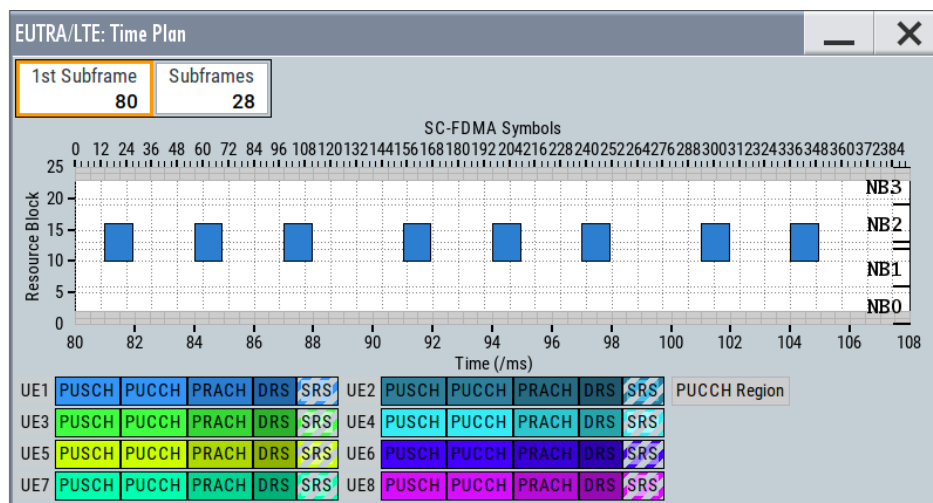

Figure 5-22: PRACH configuration visualization in the "Time Plan" ("PRACH Configuration = 9", "Repetitions = 8"; PRACH bandwidth = 6 RB)

PRACH settings:

eMTC PRACH configurations.....	479
L Hopping Offset.....	479
L Restricted Set.....	479
L CE Level.....	479
L PRACH Configuration.....	479
L Freq. Offsets.....	480
L Hopping.....	480
L Number of Repetitions.....	480
L Starting SF Periodicity.....	480
eMTC PRACH allocation per UE.....	480
L Number of Preamble Attempts.....	480
L CE Level.....	480
L Starting Subframe.....	481
L Repetitions.....	481
L Frequency Resource Index.....	481
L RB Offset.....	481
L Ncs Configuration.....	481
L Logical Root Sequence Index.....	481
L Sequence Index (v).....	482
L Delta t /us.....	482
L Power, dB.....	482
ARB Sequece Length > Sugested.....	482

eMTC PRACH configurations

Use the provided settings to configure three PRACH configurations for the different coverage levels (CE).

Hopping Offset ← eMTC PRACH configurations

Sets a PRACH hopping offset as number of resource blocks (RB).

Remote command:

[:SOURCE<hw>] :BB:EUTRa:UL:PRACH:EMTC:HOFF on page 899

Restricted Set ← eMTC PRACH configurations

Set the higher-layer parameter `High-speed-flag` and defines whether unrestricted set or one of the restricted sets ("Type A" or "Type B") is used.

The value influences the PRACH generation out of the Zadoff-Chu sequence.

Remote command:

[:SOURCE<hw>] :BB:EUTRa:UL:PRACH:EMTC:RSET on page 899

CE Level ← eMTC PRACH configurations

Indicates the CE level.

PRACH Configuration ← eMTC PRACH configurations

Selects one of the predefined 64 PRACH configurations.

Remote command:

[:SOURCE<hw>] :BB:EUTRa:UL:PRACH:EMTC:CELV<ch0>:CONFig on page 900

Freq. Offsets ← eMTC PRACH configurations

Shifts the PRACH allocation in the frequency domain in terms of resource blocks (RB).

Remote command:

`[:SOURCE<hw>] :BB:EUTRa:UL:PRACH:EMTC:CELV<ch0>:FOFFset` on page 900

Hopping ← eMTC PRACH configurations

Enables frequency hopping per CE level and PRACH configuration.

Remote command:

`[:SOURCE<hw>] :BB:EUTRa:UL:PRACH:EMTC:CELV<ch0>:HOPPing` on page 900

Number of Repetitions ← eMTC PRACH configurations

Defines how many times a PRACH is repeated.

According to [TS 36.211](#), PRACH can be repeated $N_{rep}^{PRACH} = 1, 2, 4, 8, 16, 32, 64$ or 128 times.

If "Hopping > On", the repetitions use different frequency allocations.

Remote command:

`[:SOURCE<hw>] :BB:EUTRa:UL:PRACH:EMTC:CELV<ch0>:REPetit` on page 900

Starting SF Periodicity ← eMTC PRACH configurations

Sets the higher-layer parameter N_{start}^{PRACH} :

"2, 4, 8, 16, 32, 64, 128 or 256"

Indicates the periodicity of the starting subframes in terms of subframes that are allowed for PRACH transmission.

The following applies:

"Starting SF Periodicity" ≥ [Number of Repetitions](#).

"None"

The periodicity of the allowed starting subframes is N_{rep}^{PRACH} , as set with the parameter [Number of Repetitions](#).

Remote command:

`[:SOURCE<hw>] :BB:EUTRa:UL:PRACH:EMTC:CELV<ch0>:SSFPeriod`
on page 901

eMTC PRACH allocation per UE

Comprises the UE-specific PRACH configuration.

Use this setting to can change the PRACH allocation per UE, for example:

- The number of preamble attempts
- To select starting subframe and configure PRACH allocations.

Number of Preamble Attempts ← eMTC PRACH allocation per UE

Each preamble attempt is defined in a row in the PRACH table.

Remote command:

`[:SOURCE<hw>] :BB:EUTRa:UL:UE<st>:PRACH:EMTC:PRATtempts` on page 930

CE Level ← eMTC PRACH allocation per UE

Selects the CE level. Several PRACH settings are set as configured in the common PRACH setting for the particular CE level, see ["eMTC PRACH configurations"](#) on page 479.

Each subsequent preamble attempt (i.e. subsequent row in the PRACH table) has to use a higher CE level.

Remote command:

```
[ :SOURCE<hw> ] :BB:EUTRa:UL:UE<st>:PRACH:ATT<ch0>:EMTC:CELV
on page 930
```

Starting Subframe ← eMTC PRACH allocation per UE

The value is calculated automatically, based on the CE level and the CE level and the CE level used by the previous preamble attempt.

Remote command:

```
[ :SOURCE<hw> ] :BB:EUTRa:UL:UE<st>:PRACH:ATT<ch0>:EMTC:SFStart
on page 930
```

Repetitions ← eMTC PRACH allocation per UE

Displays the values set in the general PRACH settings dialog for the selected CE level, see [Number of Repetitions](#).

Frequency Resource Index ← eMTC PRACH allocation per UE

For "Duplexing > TDD", sets the frequency resource index f_{RA} for the selected sub-frame.

Remote command:

```
[ :SOURCE<hw> ] :BB:EUTRa:UL:UE<st>:PRACH:ATT<ch0>:EMTC:FRIndex
on page 930
```

RB Offset ← eMTC PRACH allocation per UE

Indicates the starting RB. The value is calculated from the parameter [Freq. Offsets](#).

Ncs Configuration ← eMTC PRACH allocation per UE

Sets the Ncs configuration and determines the Ncs value for the preamble attempt according to [TS 36.211](#).

Table 5-50: Value range Ncs configuration

Parameter	Ncs configuration
"PRACH > Restricted Set = Off"	0 to 15
"PRACH > Restricted Set = Type A"	0 to 14
"PRACH > Restricted Set = Type B"	0 to 12
"Duplexing > TDD" and "PRACH Configuration" > 47	0 to 6

Remote command:

```
[ :SOURCE<hw> ] :BB:EUTRa:UL:UE<st>:PRACH:ATT<ch0>:EMTC:NCSCnf
on page 931
```

Logical Root Sequence Index ← eMTC PRACH allocation per UE

Sets the logical root sequence index.

Parameter	Root sequence (u)
"Duplexing > TDD" and "PRACH OCnfiguration" > 47	0 to 137
Otherwise	0 to 838

Remote command:

`[:SOURce<hw>] :BB:EUTRa:UL:UE<st>:PRACH:ATT<ch0>:EMTC:RSEquence`
on page 931

Sequence Index (v) ← eMTC PRACH allocation per UE

Sets the sequence index v .

Remote command:

`[:SOURce<hw>] :BB:EUTRa:UL:UE<st>:PRACH:ATT<ch0>:EMTC:SINDEX`
on page 931

Delta t /us ← eMTC PRACH allocation per UE

Sets the parameter Δt in us.

Any Δt value different than 0 shifts the preamble in the time domain.

Remote command:

`[:SOURce<hw>] :BB:EUTRa:UL:UE<st>:PRACH:ATT<ch0>:EMTC:DT`
on page 931

Power, dB ← eMTC PRACH allocation per UE

Sets the preamble attempt power relative to the UE power.

Remote command:

`[:SOURce<hw>] :BB:EUTRa:UL:UE<st>:PRACH:ATT<ch0>:EMTC:POWer`
on page 932

ARB Sequece Length > Sugested

Indicates the ARB sequence length that is required for the current PRACH configuration.

Use the "Adjust Length" function to apply the suggested value.

Remote command:

`[:SOURce<hw>] :BB:EUTRa:UL:UE<st>:PRACH:EMTC:ARB:SUGGested?`
on page 932

6 Observing current allocations on the time plan

You can observe the current allocations on the time plan. There are dedicated uplink and downlink time plans and, if TDD duplexing mode is used, the time plan also visualizes the special subframes.

The time plan shows active channels and signals, the allocations of the active UEs and indicates the cell it applies for if a carrier aggregation is used. Per default, the time plan shows the allocation per used channel bandwidth and one subframe but you can extend the displayed time region to up to 40 subframes. You can also scroll over all available subframes and open the time plan in a separate window.

- [OFDMA time plan](#).....483
- [SC-FDMA time plan](#)..... 485
- [TDD time plan](#)..... 486
- [eMTC/NB-IoT indication in the DL time plan](#).....487
- [eMTC/NB-IoT indication in the UL time plan](#).....490
- [TDD time plan](#)..... 491

6.1 OFDMA time plan

Access:

1. Select "General > Link Direction > Downlink (OFDMA)".
2. Select "Frame Configuration > Time Plan".

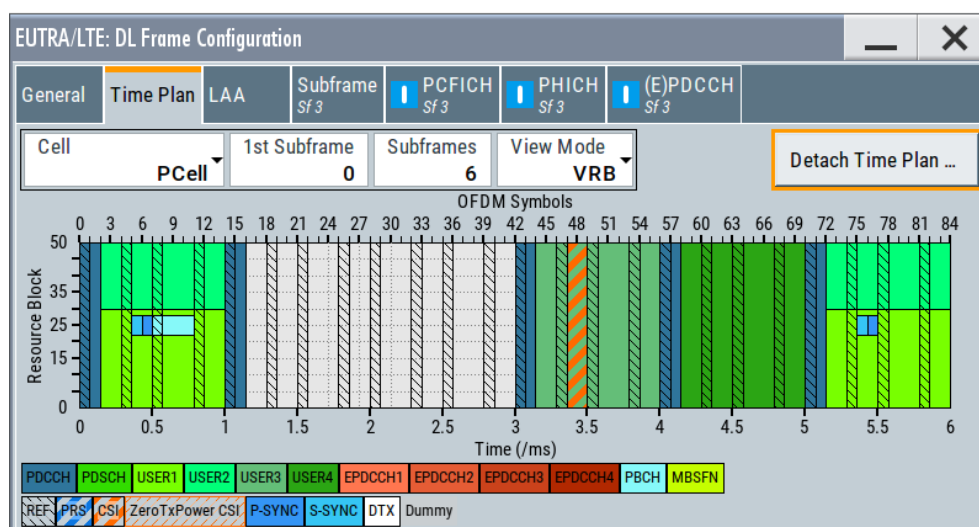

The x-axis shows allocation in the time domain. The y-axis shows the resource blocks as smallest allocation granularity in the frequency domain. One allocation to a UE can span 1 to up to "No. of Resource Blocks" in the frequency domain.

P-SYNC/S-SYNC is automatically calculated according to the settings in [General DL Settings](#) dialog.

Cell

With enabled "General DL Settings > CA > Activate Carrier Aggregation > On" state, indicates to which cell (i.e. component carrier) the settings apply.

Remote command:

n.a.

First Subframe

Selects the first subframe to be displayed.

Remote command:

n.a.

Subframes

Selects the number of subframes to be displayed.

Remote command:

n.a.

View Mode

Determines how the allocations are displayed.

If at least one NB-LoT UE is enabled, you use this parameter to zoom in and out in the frequency domain.

"PRB/VRB" The "Time Plan" displays the entire channel bandwidth. It shows the allocated virtual resource blocks (VRBs) or the physical resource blocks (PRBs).

In this granularity, an in-band or guard band NB-LoT allocation is indicated as one resource block; NRS are not visible. This mode is not available in standalone NB-LoT operation.

"Single RB" The "Time Plan" displays the allocation of the anchor carrier (one single RB) as selected in the RB index field.

The NRS, NPSS/NSSS and the downlink channels are shown in greater detail.

Note that the y-axis indicates the frequency allocation in terms of number of subcarriers.

Remote command:

n.a.

Detach Time Plan

Enlarges the time plan display.

6.2 SC-FDMA time plan

Access:

1. Select "General > Link Direction > Uplink (SC-FDMA)".
2. Select "Frame Configuration > Time Plan".

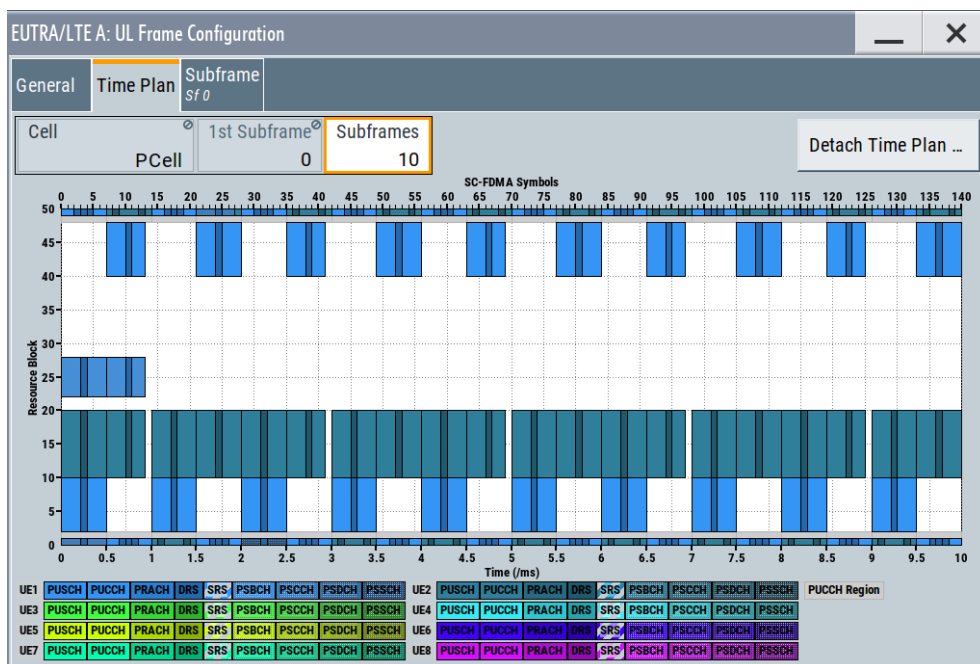

This dialog shows the uplink time plan.

The x-axis shows allocation in the time domain. The y-axis shows the resource blocks as smallest allocation granularity in the frequency domain. One allocation of a UE can span 1 to up to "No. of Resource Blocks" in the frequency domain.

Sounding Reference Signals (SRS) are automatically calculated according to the settings for signal structure in "User Equipment" dialog.

An enabled SFN offset is also displayed, see "[SFN Offset](#)" on page 231.

Cell

In enabled "General UL Settings > CA > Activate Carrier Aggregation > On" state, determines the settings of which cell (Primary Cell or SCell) are displayed.

First Subframe

Selects the first subframe to be displayed.

Remote command:

n.a.

Subframes

Selects the number of subframes to be displayed.

Remote command:
n.a.

Detach Time Plan
Enlarges the time plan display.

6.3 TDD time plan

1. To access this dialog, select "General > Duplexing > TDD".
2. Select "Frame Configuration > Time Plan"

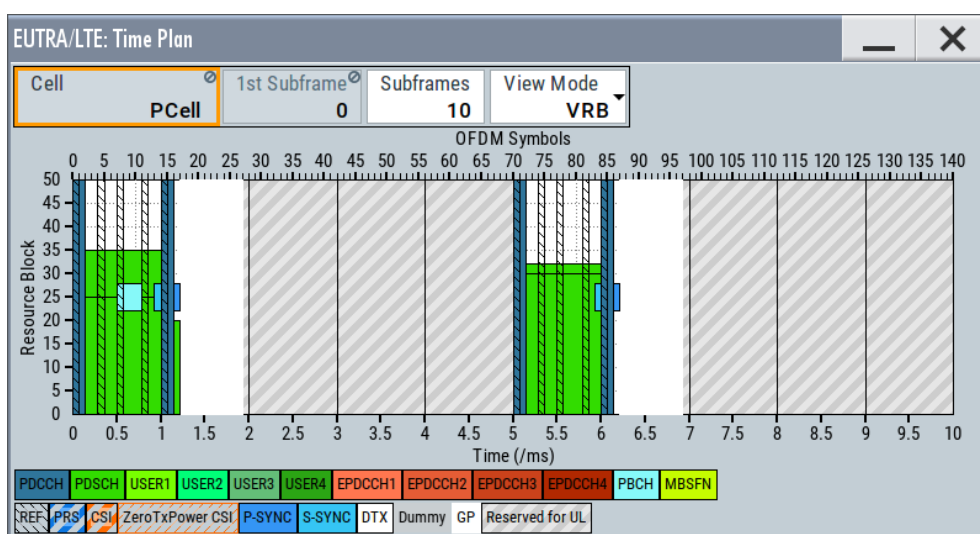

Figure 6-1: TDD time plan (DL)

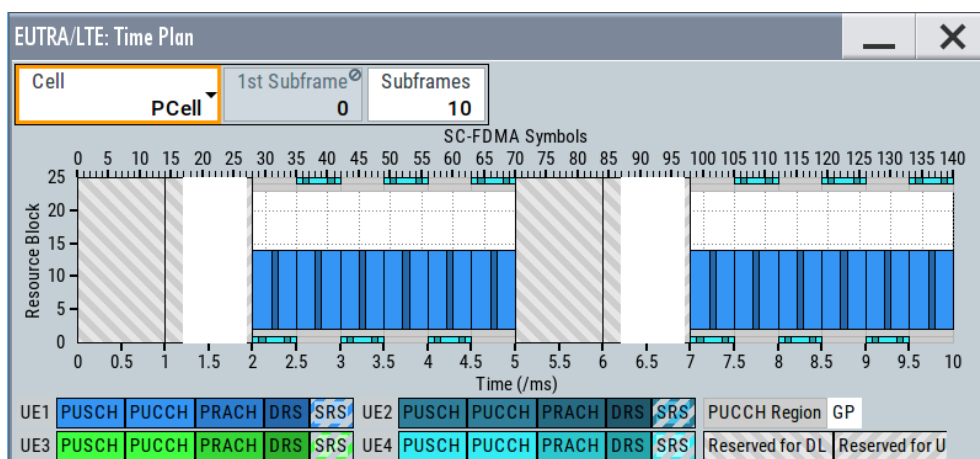

Figure 6-2: TDD time plan (UL)

This dialog shows the time plan for "Duplexing Mode > TDD".

The x-axis shows allocation in the time domain. The y-axis shows the resource blocks as smallest allocation granularity in the frequency domain.

The frame structure depends on the selected "DL/UL Configuration" and the "Configuration of Special Subframe".

First Subframe

Selects the first subframe to be displayed.

Remote command:

n.a.

Subframes

Selects the number of subframes to be displayed.

Remote command:

n.a.

View Mode

Determines how the allocations are displayed.

If at least one NB-LoT UE is enabled, you use this parameter to zoom in and out in the frequency domain.

"PRB/VRB"	<p>The "Time Plan" displays the entire channel bandwidth. It shows the allocated virtual resource blocks (VRBs) or the physical resource blocks (PRBs).</p> <p>In this granularity, an in-band or guard band NB-LoT allocation is indicated as one resource block; NRS are not visible. This mode is not available in standalone NB-LoT operation.</p>
"Single RB"	<p>The "Time Plan" displays the allocation of the anchor carrier (one single RB) as selected in the RB index field.</p> <p>The NRS, NPSS/NSSS and the downlink channels are shown in greater detail.</p> <p>Note that the y-axis indicates the frequency allocation in terms of number of subcarriers.</p>

Remote command:

n.a.

Detach Time Plan

Enlarges the time plan display.

6.4 eMTC/NB-LoT indication in the DL time plan

Access:

1. In the "General" dialog, select "Mode > LTE/eMTC/NB-LoT".
2. Select "**Link Direction > Downlink**".

3. In the "General DL Settings > NB-LoT Carriers" dialog, for the anchor carrier set "Mode = In-Band"
4. Select "Frame Configuration > Time Plan".

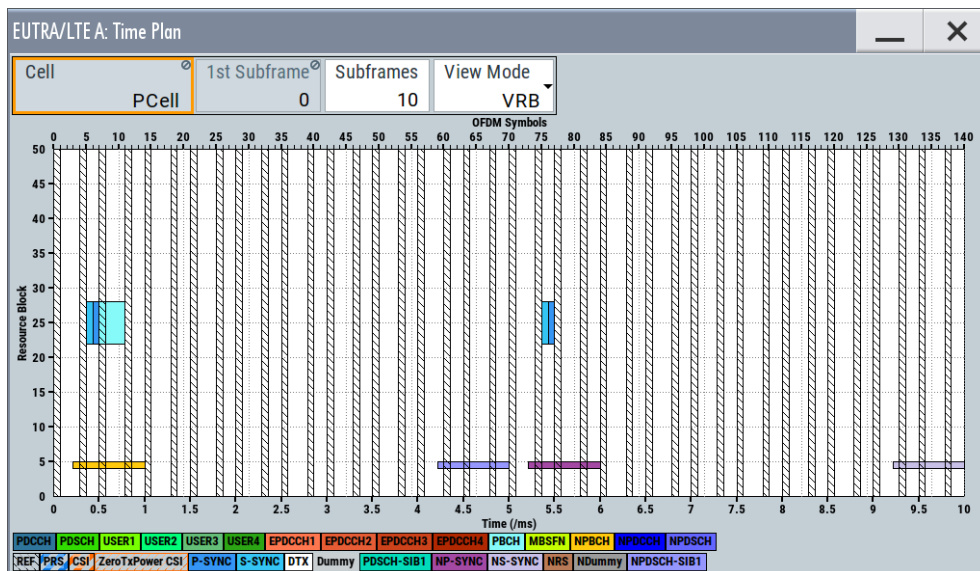

5. To display the NB-LoT allocations in greater detail:
 - a) Select "View Mode > Single RB".
 - b) Select the RB number in that the anchor carrier is allocated, for example "RB = 2".

This dialog shows the downlink time plan.

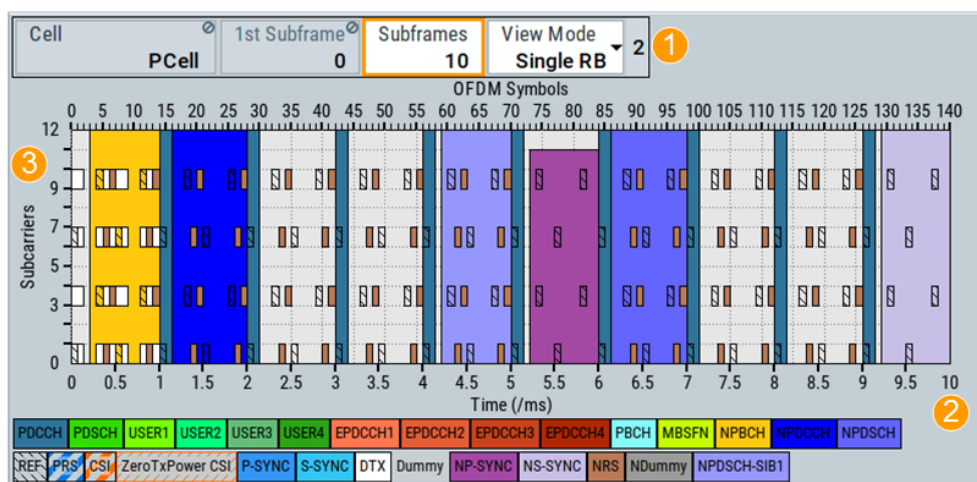

Figure 6-3: Time Plan: understanding the displayed information

- 1 = "View Mode > Single RB"
- 2 (x-axis) = Shows the allocations in the time domain
- 3 (y-axis) = Shows the allocations in the frequency domain, expressed in the smallest allocation granularity

Note that the y-axis indicates the frequency allocation in terms of **number of sub-carriers**.

Allocations are calculated as configured in the "DL Frame Configuration > NB-LoT Allocations" dialog.

With the default settings as in this example, displayed are only the NPBCH and the NPSS/NSSS; other downlink channels are not configured.

Settings:

First Subframe.....	489
Subframes.....	489
View Mode.....	489
Detach Time Plan.....	489

First Subframe

Selects the first subframe to be displayed.

Remote command:

n.a.

Subframes

Selects the number of subframes to be displayed.

Remote command:

n.a.

View Mode

Determines how the allocations are displayed.

If at least one NB-LoT UE is enabled, you use this parameter to zoom in and out in the frequency domain.

"PRB/VRB"	<p>The "Time Plan" displays the entire channel bandwidth. It shows the allocated virtual resource blocks (VRBs) or the physical resource blocks (PRBs).</p> <p>In this granularity, an in-band or guard band NB-LoT allocation is indicated as one resource block; NRS are not visible. This mode is not available in standalone NB-LoT operation.</p>
"Single RB"	<p>The "Time Plan" displays the allocation of the anchor carrier (one single RB) as selected in the RB index field.</p> <p>The NRS, NPSS/NSSS and the downlink channels are shown in greater detail.</p> <p>Note that the y-axis indicates the frequency allocation in terms of number of subcarriers.</p>

Remote command:

n.a.

Detach Time Plan

Enlarges the time plan display.

6.5 eMTC/NB-LoT indication in the UL time plan

Access:

1. In the "General" dialog, select "Mode > LTE/eMTC/NB-LoT".
2. Select "Link Direction > Uplink (SC-FDMA)".
3. Select "Frame Configuration > Time Plan".
4. Select "View Mode > Channel BW".

This dialog shows the uplink time plan.

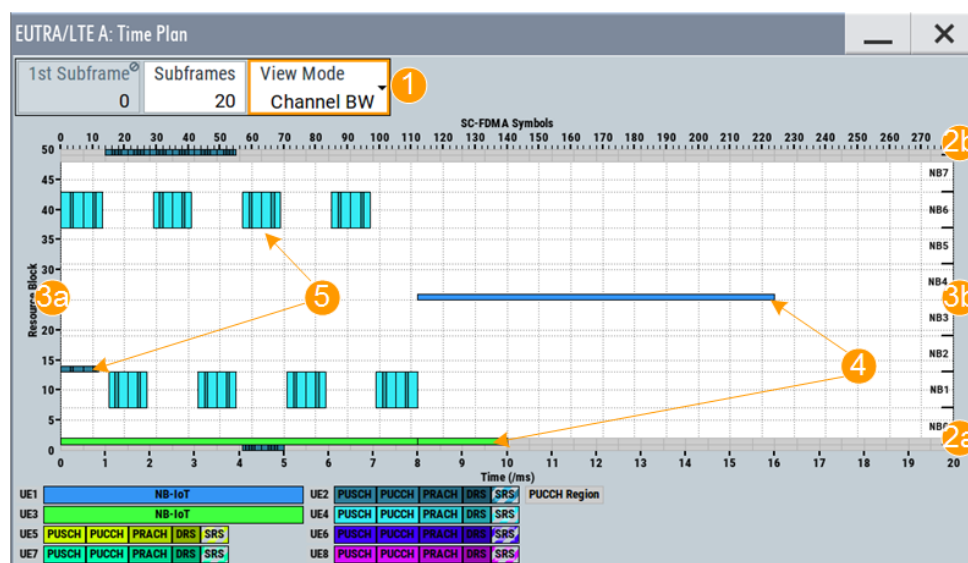

Figure 6-4: Time Plan: understanding the displayed information

- 1 = "View Mode > Channel BW"
- x-axis = Shows the allocations in the time domain
- 2a, 2b = Time, expressed in the time units and as number of SC-FDMA symbols
- y-axis = Shows the allocations in the frequency domain, expressed in the smallest allocation granularity
- 3a, 3b = Frequency, expressed as number of resource blocks (RB) for the LTE and eMTC UEs and narrowband (NB) for the NB-LoT UEs
- 4 = NB-LoT allocations of UE1 and UE3
- 5 = eMTC allocations of UE2

Allocations are calculated as configured in the "User Equipment" dialog.

5. To display the NB-LoT allocations in greater detail:
 - a) Select "View Mode > Single RB".
 - b) Select the number of RB, for example "RB = 1" or "RB = 24".

See for example the time plan on [Figure 5-20](#).

Note that the y-axis indicates the frequency allocation in terms of number of subcarriers. The left and the right y-axis shows the subcarrier numbering depending on the subcarrier spacing ("@15kHz" and "@3.75kHz").

Settings:

First Subframe.....	491
Subframes.....	491
View Mode.....	491
Detach Time Plan.....	491

First Subframe

Selects the first subframe to be displayed.

Remote command:

n.a.

Subframes

Selects the number of subframes to be displayed.

Remote command:

n.a.

View Mode

If at least one NB-LoT UE is enabled, you use this parameter to zoom in and out in the frequency domain.

"Channel BW"	<p>The "Time Plan" displays the entire channel bandwidth. In this granularity, an NB-LoT allocation is indicated as one resource block. NPUSCH or NPRACH hops are not visible.</p>
"Single RB"	<p>The "Time Plan" displays one single RB as selected in the RB index field. The NPRACH and NPUSCH incl. the NDRS signals are shown in greater detail. Frequency hops are visible. Note that the y-axis indicates the frequency allocation in terms of number of subcarriers.</p> <p>The left and the right y-axis shows the subcarrier numbering depending on the subcarrier spacing:</p> <ul style="list-style-type: none"> • "@15kHz", one RB consists of 12 subcarriers. • "@3.75kHz", there are 48 subcarriers.

Detach Time Plan

Enlarges the time plan display.

6.6 TDD time plan

Access:

1. Select "General > Duplexing > TDD".

2. Select "Frame Configuration > Time Plan"

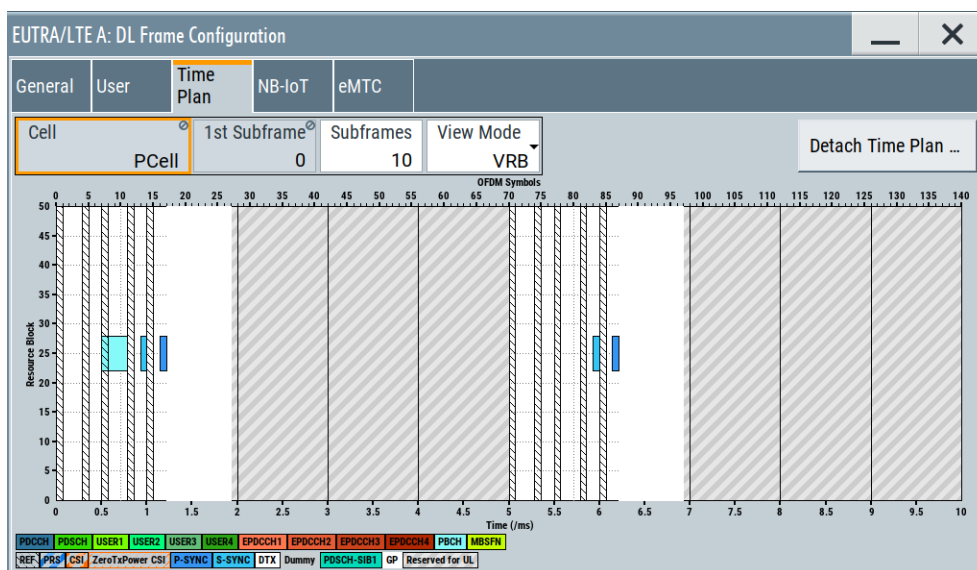

The x-axis shows allocation in the time domain. The y-axis shows the resource blocks as smallest allocation granularity in the frequency domain. The frame structure depends on the selected "DL/UL Configuration" and the "Configuration of Special Subframe".

First Subframe

Selects the first subframe to be displayed.

Remote command:

n.a.

Subframes

Selects the number of subframes to be displayed.

Remote command:

n.a.

View Mode

Determines how the allocations are displayed.

If at least one NB-IoT UE is enabled, you use this parameter to zoom in and out in the frequency domain.

"PRB/VRB"

The "Time Plan" displays the entire channel bandwidth. It shows the allocated virtual resource blocks (VRBs) or the physical resource blocks (PRBs).

In this granularity, an in-band or guard band NB-IoT allocation is indicated as one resource block; NRS are not visible. This mode is not available in standalone NB-IoT operation.

"Single RB" The "Time Plan" displays the allocation of the anchor carrier (one single RB) as selected in the RB index field.
The NRS, NPSS/NSSS and the downlink channels are shown in greater detail.
Note that the y-axis indicates the frequency allocation in terms of number of subcarriers.

Remote command:

n.a.

Detach Time Plan

Enlarges the time plan display.

7 Performing BS tests according to TS 36.141

The "Test Case Wizard" supports tests on base stations in conformance with the 3GPP specification for Base Station conformance testing. It offers a selection of predefined settings according to Test Cases in [TS 36.141](#). For an overview of the test cases covered by the test case wizard, refer to [Chapter 7.3, "Supported test cases"](#), on page 496.

With the "Test Case Wizard", it is possible to create highly complex test scenarios with just a few keystrokes.

The "Test Case Wizard" has effect on frequency and level settings, link direction, filter, trigger, baseband clock source, marker settings and base station or user equipment configuration.

The "Test Case Wizard" also effects:

- AWGN
- CW interferers.



The "Test Case Wizard" presets the instrument for tests according to the test specification. If it is required, you can change the predefined settings by varying the corresponding parameter in the EUTRA dialogs.

7.1 Introduction to conformance testing

The main purpose of the conformance testing is to ensure that the base station (BS) and the user equipment (UE) are fulfilling a defined level of minimum performance.

The 3GPP organization defines three groups of conformance testing for the UE: Radio Frequency (RF), Radio Resource Management (RRM) and Signaling. There is only one group conformance testing for the BS, the RF conformance tests.

This chapter is intended to give an overview of the 3GPP test specifications dealing with the conformance tests. Only a brief description is provided.

7.1.1 UE conformance testing



The UE conformance tests are not in the scope of this description.

UE RF FDD/TDD Conformance Test Specifications

The UE RF conformance tests are based on the core specification [TS 36.101](#) and are defined in the [TS 36.521](#). The following list gives an overview of the related specifications:

- [TS 36.124](#) "ElectroMagnetic Compatibility (EMC) requirements for mobile terminals and ancillary equipment"
- [TS 36.521-1](#) "User Equipment (UE) conformance specification; Radio transmission and reception; Part 1: Conformance testing"

Overview of the test cases:

- Subclause 6: UE RF transmitter test cases
Transmit power, Output power dynamics, Transmit signal quality, Output RF spectrum emissions and Transmit intermodulation
 - Subclause 7: UE RF receiver test cases
Diversity characteristics, Reference sensitivity power level, Maximum input level, Adjacent Channel Selectivity (ACS), In-band blocking, Out-of-band blocking, Narrow band blocking, Spurious response, Intermodulation characteristics, Spurious emissions
 - Subclause 8: UE RF FDD/TDD performance test cases
Demodulation of PDSCH (Cell-Specific Reference Symbols), Demodulation of PDSCH (User-Specific Reference Symbols), Demodulation of PDCCH/PCFICH, Demodulation of PHICH, Demodulation of PBCH
- [TS 36.521-2](#) "User Equipment (UE) conformance specification; Radio transmission and reception; Part 2: Implementation Conformance Statement (ICS)"
 - [TS 36.521-3](#) "User Equipment (UE) conformance specification; Radio transmission and reception; Part 3: Radio Resource Management (RRM) conformance testing"

UE RRM Conformance Test Specifications

The following specifications deal with UE RRM conformance testing:

- [TS 36.133](#) "Requirements for support of radio resource management"
- [TS 36.521-3](#) "User Equipment (UE) conformance specification; Part 3: Test suites"

UE Signaling Conformance Test Specifications

The UE signaling conformance tests are defined in the [TS 36.523](#).

- [TS 36.523-1](#) "User Equipment (UE) conformance specification; Part 1: Protocol conformance specification"
- [TS 36.523-2](#) "User Equipment (UE) conformance specification; Part 2: Implementation Conformance Statement (ICS) pro-forma specification"
- [TS 36.523-3](#) "User Equipment (UE) conformance specification; Part 3: Test suites"

7.1.2 BS conformance testing

BS RF FDD/TDD Conformance Test Specifications

The BS RF conformance tests are based on the core specification [TS 36.101](#) and are defined in the [TS 36.141](#)

- [TS 36.113](#) "Base Station (BS) and repeater ElectroMagnetic Compatibility (EMC)"
- [TS 36.141](#) "Base Station (BS) conformance testing"
The BS RF Conformance Tests are described in [Chapter 7.3, "Supported test cases"](#), on page 496.

7.1.3 Repeater conformance testing

The repeater conformance tests are based on the core specification [TS 36.106](#) and defined in the [TS 36.143](#) "FDD repeater conformance testing".

7.2 Required options

The basic equipment layout for performing test with the aid of "Test Case Wizard" is the same as for the EUTRA/LTE signal generation. It includes the options:

- Baseband Generator(R&S SMM-B9)
- Digital Standard EUTRA/LTE (R&S SMM-K55)
- Frequency option (e.g. R&S SMM-B1006)

Some of the tests require further options. You find a list of the required option at the beginning of each section that describes a group of test cases.

The following equipment and options are required to support further of the test cases:

- Option Additive White Gaussian Noise AWGN (R&S SMM-K62)
- Option Digital Standard EUTRA/LTE Release 10, LTE-Advanced (R&S SMM-K85)



Test cases where the signal generator hardware and/or software equipment is not sufficient are shown in grey color but are not selectable.

RF power and frequency limitations of the hardware equipment restrict the setting ranges.

7.3 Supported test cases

The BS RF conformance tests defined in the [TS 36.141](#) are divided into three main parts, the RF transmitter characteristics, the RF receiver characteristics and the RF performance requirements.

The "Test Case Wizard" supports the test cases listed in the tables below.



Only the test cases that require a signal generator are implemented in the "Test Case Wizard".

Table 7-1: Transmitter Tests

Chapter in TS 36.141	Test Case	Section in this document with further information
Output power dynamics		these test cases do not require a signal generator
6.3.1	RE Power control dynamic range	
6.3.2	Total power dynamic range	
6.4	Transmit ON/OFF power	
Transmitted signal quality		
6.5.1	Frequency error	
6.5.2	Error Vector Magnitude	
6.5.3	Time alignment between transmitter branches	
6.5.4	DL RS power	
Unwanted emissions		
6.6.1	Occupied bandwidth	
6.6.2	Adjacent Channel Leakage power Ratio (ACLR)	
6.6.3	Operating band unwanted emissions	
6.6.4	Transmitter spurious emissions	
6.7	Transmitter intermodulation	

Table 7-2: Receiver Characteristics

Chapter in TS 36.141	Test Case	Section in this document with further information
7.2	Reference sensitivity level	chap. 7.8.4, on page 522
7.3	Dynamic range	chap. 7.8.5, on page 523
7.4	In-channel selectivity	chap. 7.8.6, on page 524

7.3.1 Generic structure of the description of the implemented test cases

The description of the test cases in this document follows a common structure.

- Test Case Number and Test Case Name
- Short Description and Test Purpose
Some of the definitions are directly taken from the 3GPP test specification.
- Prerequisites, required hardware and software options

- Test setup
- Description of test case-specific parameters

7.4 Standard test setups

The tests can be performed using the standard test setup according to TS 36.141. Test setups beside the three standard test setups described below are specified at the individual description of the corresponding test case.

7.4.1 Standard test setup - one path

The RF port outputs the wanted signal (with or without interference) and is connected to the Rx port of the base station. The signal generator will start signal generation at the first received eNB frame trigger.

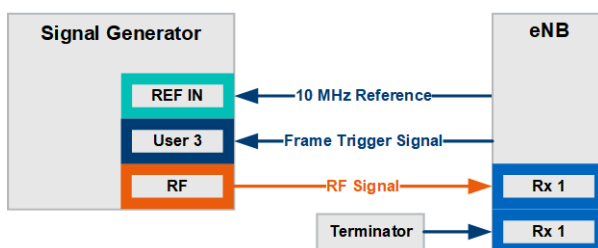

Figure 7-1: One Path Standard Test Setup (Example of simulating the test case 7.3 "Dynamic Range")

7.5 General considerations

This section lists some common topics for all BS RF conformance tests. Considerations specific to one conformance test part, are described at the corresponding section.

Test Frequencies

EUTRA/LTE is designed to operate in the operating bands defined in Table 7-3. The table shows the start and the stop frequencies of both uplink and downlink frequency bands according to TS 36.141.

Table 7-3: EUTRA/LTE operating bands

EUTRA Operating Band	Uplink (UL) band BS receive UE transmit F_{UL_low} to F_{UL_high}	Downlink (DL) operating band BS transmit UE receive F_{DL_low} to F_{DL_high}	Duplex Mode
1	1920 MHz to 1980 MHz	2110 MHz to 2170 MHz	FDD
2	1850 MHz to 1910 MHz	1930 MHz to 1990 MHz	FDD
3	1710 MHz to 1785 MHz	1805 MHz to 1880 MHz	FDD
4	1710 MHz to 1755 MHz	2110 MHz to 2155 MHz	FDD

EUTRA Operating Band	Uplink (UL) band BS receive UE transmit F_{UL_low} to F_{UL_high}	Downlink (DL) operating band BS transmit UE receive F_{DL_low} to F_{DL_high}	Duplex Mode
5	824 MHz to 849 MHz	869 MHz to 894MHz	FDD
6	830 MHz to 840 MHz	875 MHz to 885 MHz	FDD
7	2500 MHz to 2570 MHz	2620 MHz to 2690 MHz	FDD
8	880 MHz to 915 MHz	925 MHz to 960 MHz	FDD
9	1749.9 MHz to 1784.9 MHz	1844.9 MHz to 1879.9 MHz	FDD
10	1710 MHz to 1770 MHz	2110 MHz to 2170 MHz	FDD
11	1427.9 MHz to 1447.9 MHz	1475.9 MHz to 1495.9 MHz	FDD
12	699 MHz to 716 MHz	729 MHz to 746 MHz	FDD
13	777 MHz to 787 MHz	746 MHz to 756 MHz	FDD
14	788 MHz to 798 MHz	758 MHz to 768 MHz	FDD
...			
17	704 MHz to 716 MHz	734 MHz to 746 MHz	FDD
...			
33	1900 MHz to 1920 MHz	1900 MHz to 1920 MHz	TDD
34	2010 MHz to 2025 MHz	2010 MHz to 2025 MHz	TDD
35	1850 MHz to 1910 MHz	1850 MHz to 1910 MHz	TDD
36	1930 MHz to 1990 MHz	1930 MHz to 1990 MHz	TDD
37	1910 MHz to 1930 MHz	1910 MHz to 1930 MHz	TDD
38	2570 MHz to 2620 MHz	2570 MHz to 2620 MHz	TDD
39	1880 MHz to 1920 MHz	1880 MHz to 1920 MHz	TDD
40	2300 MHz to 2400 MHz	2300 MHz to 2400 MHz	TDD

The measurements that have to be performed according to [TS 36.141](#) for verifying a proper operation of systems apply to appropriate frequencies in the bottom, middle and top of the operating frequency band of the base station (BS). These frequencies are denoted as RF channels B (bottom), M (middle) and T (top).

Reference Frequency

When building up the measurement setups according to [TS 36.141](#) it might be useful that all the instruments share a common reference clock. When you feed an external clock, the RF module configuration should be switched to external reference frequency.

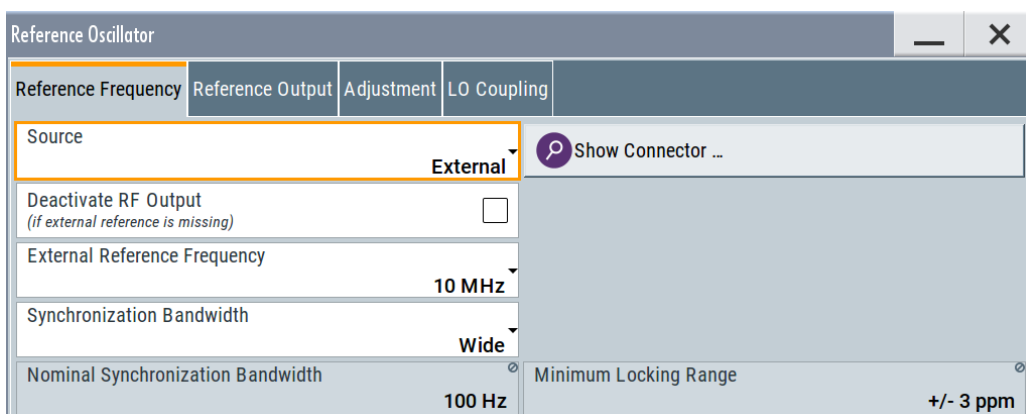

In the external reference mode an external signal with selectable frequency and defined level must be input at the Ref In connector. This signal is output at the Ref Out connector. The reference frequency setting is effective for both paths. For achieving very good reference sources of high spectral purity a wideband setting is provided.

Baseband Clock

The clock source is automatically switched to internal when the test case settings are activated.

Improvement of signal quality

Improvement of signal quality is possible via several settings:

- In the "I/Q Mod > I/Q Settings > General" dialog, select a "Baseband Gain = 2 dB" to improve the ACLR performance
- In the "RF > RF Level > Automatic Level Control Settings" dialog, select "State > Off (Sample&Hold)".
This is recommended for multi-transmitter measurements if in CW mode the signal/intermodulation ratio is to be improved.
With setting "Auto", the level control is automatically adapted to the operating conditions, it may cause increased intermodulation, however.

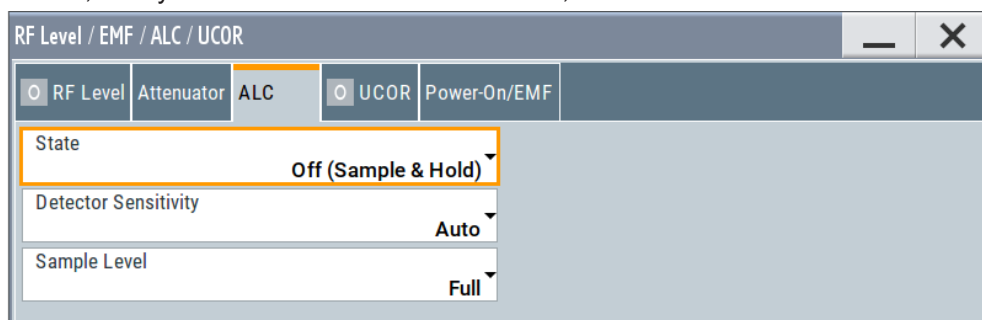

- To consider the frequency response of the test setup, select "RF > User Correction" and create a list of correction values.

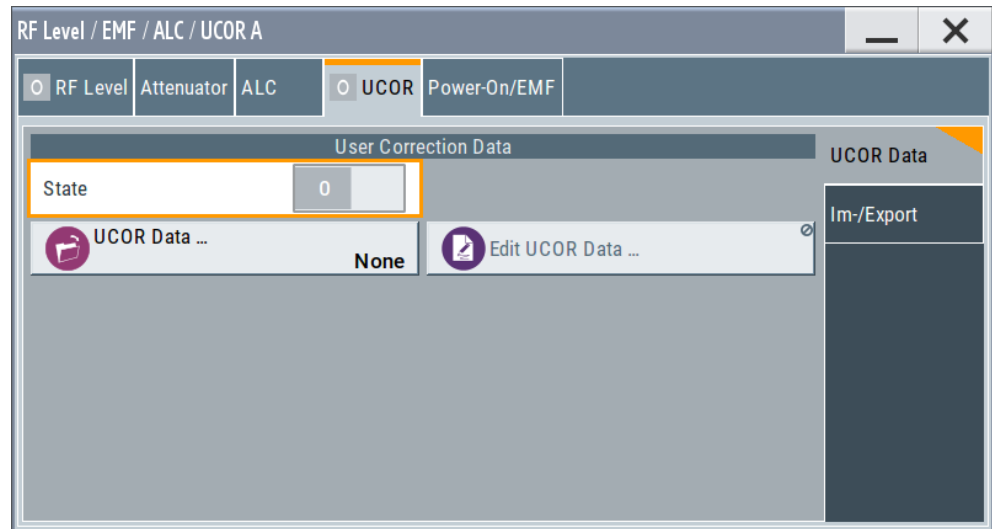

- To compensate cable loss and additionally inserted attenuator, adjust the RF level ("Status Bar > Level").

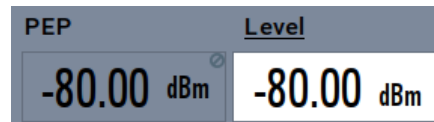

Virtual Resource Block (VRB) Offset

In this implementation, the RBs are allocated by default at the left edge of the spectrum. However, some test cases do not require allocation of the entire bandwidth or RB allocation at a specific part of the bandwidth. Adjust the additional parameter "Offset VRB" to define the position of the RBs.

Example: Offset VRB

"Channel Bandwidth" = 10 MHz, i.e. 50 RBs

"Allocated Resource Blocks" = 25

"Offset VRB" = 10

The RBs are offset by 10 RBs and allocated RBs start at position 11.

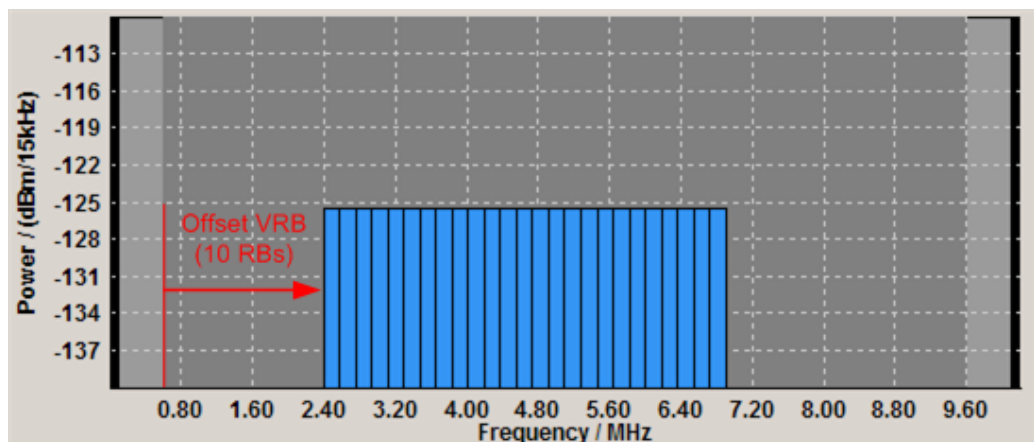



Use also the [SC-FDMA time plan](#) to visualize the RB allocation for the wanted signal (path A) and the interfering signal (path B).

7.6 User interface

Access:

- ▶ Select "Baseband Block > EUTRA/LTE > Test Case Wizard".

The "Test Case Wizard" dialog is divided into several tabs: the "Test Case" tab for selecting the test case, the "Instrument" tab for settings trigger and marker configuration, one or more tabs with corresponding names comprising the additional parameters like the configuration of the "Wanted Signal", AWGN settings and the "Apply" button.

7.6.1 Test case settings

Access:

1. Select "Baseband Block > EUTRA/LTE > Test Case Wizard".
2. Select "Test Case".

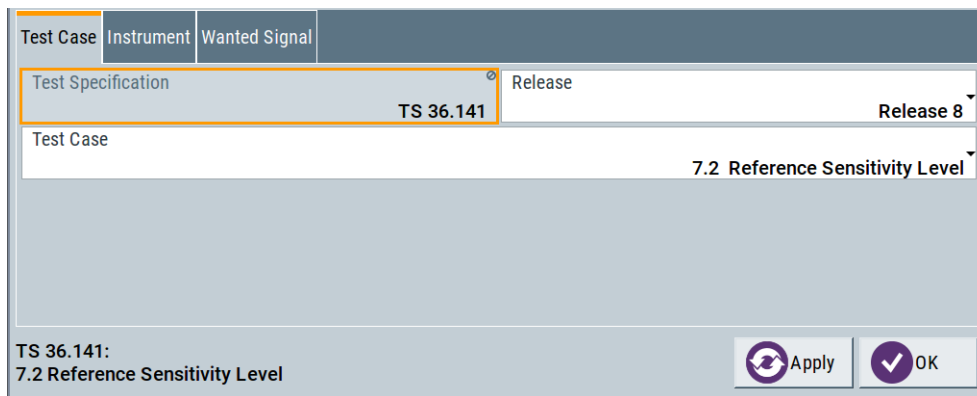

This dialog comprises the settings for selecting the test case, the 3GPP test specification and release as well as other general settings.

Test Specification	502
Release	503
Base Station Class	503
Test Case	503

Test Specification

Selects the 3GPP test specification used as a guide line for the test cases.

Remote command:

[:SOURce<hw>] :BB:EUTRa:TCW:GS:SPEC on page 934

Release

Displays the 3GPP test specification release version used as a guide line for the test cases.

Remote command:

[:SOURce<hw>] :BB:EUTRa:TCW:GS:RELease on page 934

Base Station Class

Determines whether the test is to be performed for a local area, home area, medium range or a wide area base station. The different base station classes are specified for different output power ("[Power Level](#)" on page 507).

Remote command:

[:SOURce<hw>] :BB:EUTRa:TCW:GS:BSCLass on page 935

Test Case

Selects the test case.

Note: Not all test case are available for all instruments. The enabled test cases depend on the instrument's hardware (e.g. instrument equipped with one or two paths, etc) and/or the installed SW options (e.g. Fading Simulator, etc.).

See [Chapter 7.3, "Supported test cases"](#), on page 496 for an overview of the available test cases.

Remote command:

[:SOURce<hw>] :BB:EUTRa:TCW:TC on page 939

7.6.2 Instrument settings

Access:

1. Select "Baseband Block > EUTRA/LTE > Test Case Wizard".
2. Select "Instrument".

The "Instrument" dialog comprises instrument-related settings, like trigger and marker settings or routing related settings.

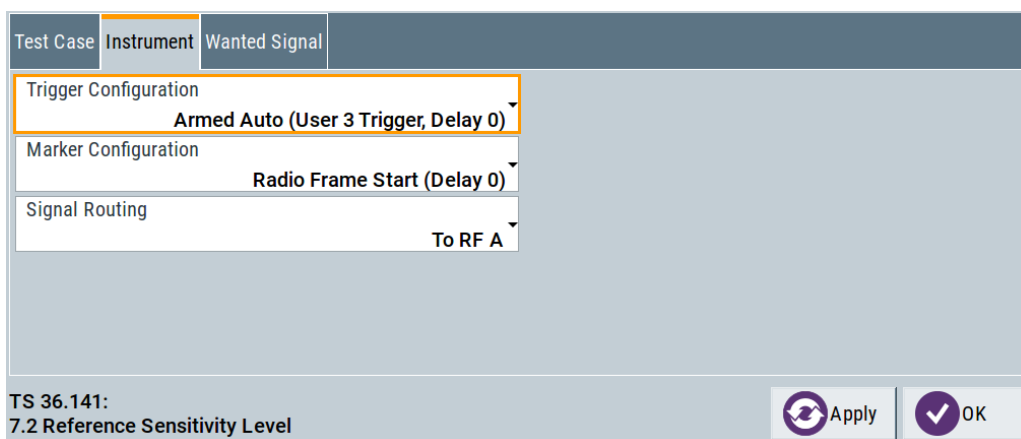

Trigger Configuration.....504
 Marker Configuration.....504

Trigger Configuration

Selects the trigger configuration. The trigger is used to synchronize the signal generator to the other equipment.

"Armed Auto (User 3 Trigger, Delay 0)"

The trigger settings are customized for the selected test case. The following settings apply:

- "Trigger Mode > Armed Auto"
- "Trigger Source > External Global Trigger 1"
- "Global Connector Settings > User 3 > Direction > Input" and "User 3 > Signal > Global Trigger 1"
- "Trigger Delay = 0"

Thus, the base station frame timing is able to synchronize the signal generator by a periodic trigger.

"Unchanged" The current trigger settings of the signal generator are retained unchanged.

Remote command:

[:SOURce<hw>] :BB:EUTRa:TCW:GS:TRIGgerconfig on page 936

Marker Configuration

Selects the marker configuration. The marker can be used to synchronize the measuring equipment to the signal generator.

"Radio Frame Start (Delay 0)"

The marker settings are customized for the selected test case. The following settings apply:

- "Marker Mode 1/2/3 > Radio Frame Start"
- "Global Connector Settings > User 1/2 > Direction > Output" and "User 1/2 > Signal > Baseband A Marker 1/2"
- "Marker Delay = 0"

"Unchanged" The current marker settings of the signal generator are retained unchanged.

Remote command:

`[:SOURce<hw>] :BB:EUTRa:TCW:GS:MARKerconfig` on page 935

7.6.3 Frequency allocation settings

Determines the frequency position of the wanted and the interfering signal.

Test Case	Instrument	Frequency Allocation	BS Wanted Signal	Interfering Signal
		Interfering Signal At Higher Frequencies		

Frequency Allocation of the Interfering signal

Determines the frequency position of the wanted and the interfering signal.

Example: Wanted and interfering signal within the same channel

"Test Case" = 7.4 "In Channel Selectivity"

"Channel Bandwidth" = 1.4 MHz

The parameter "Frequency Allocation" determines the position of the allocated RBs within the channel. Allocation in the lower or higher frequencies is possible.

Example: Interfering signal in the adjacent channel

"Test Case" = 7.5A "Adjacent Channel Selectivity"

"Channel Bandwidth" = 1.4 MHz

The parameter "Frequency Allocation" determines the position of the wanted signal compared to the interfering signal. Allocation in the lower or higher frequencies is possible, i.e. the position of the allocated bandwidth of the wanted and the interfering signal can be mirrored.

Remote command:

`[:SOURce<hw>] :BB:EUTRa:TCW:FA:FRALlocation` on page 934

`[:SOURce<hw>] :BB:EUTRa:TCW:FA:RBALlocation` on page 934

7.6.4 Wanted signal and cell-specific settings

The following settings are available for almost all transmitter and receiver characteristics and performance requirements tests. Specific parameters are listed together with the description of the corresponding test case.

For the in-channel test cases 7.4, 8.2.2 and 8.3.3, the cell-specific settings apply also for the interfering signal, respectively for the signal of the stationary UE.

Test Case	Instrument	Wanted Signal	
RF Frequency		1.950 000 000 GHz	Duplexing FDD
Channel Bandwidth		1.4 MHz	Cell ID 150
UE ID / n_RNTI		1	
FRC		A1-1	Offset VRB 0
Power Level			

RF Frequency..... 506

Duplexing..... 506

TDD UL/DL Configuration..... 506

Signal Advance N_TA_offset..... 506

Channel Bandwidth..... 506

Cell ID..... 507

Cyclic Prefix..... 507

UE ID/n_RNTI..... 507

FRC..... 507

Offset VRB..... 507

Power Level..... 507

RF Frequency

Sets the RF frequency of the wanted signal.

Remote command:

```
[ :SOURce<hw> ] :BB:EUTRa:TCW:WS:RFFrequency on page 942
```

Duplexing

Selects whether TDD or FDD duplexing mode is used.

See also "Duplexing" on page 64.

Remote command:

```
[ :SOURce<hw> ] :BB:EUTRa:TCW:WS:DUPLex on page 940
```

TDD UL/DL Configuration

For TDD mode, selects the UL/DL Configuration number (see also "TDD UL/DL Configuration" on page 100).

Remote command:

```
[ :SOURce<hw> ] :BB:EUTRa:TCW:WS:TDDConfig on page 942
```

Signal Advance N_TA_offset

Sets the parameter $N_{TAoffset}$.

See also "Signal Advance N_TA_offset" on page 549.

Remote command:

```
[ :SOURce<hw> ] :BB:EUTRa:TCW:WS:NTAOffset on page 941
```

Channel Bandwidth

Selects the channel bandwidth.

See also [Chapter 4.6.2, "Physical settings"](#), on page 225.

Remote command:

[:SOURCE<hw>] :BB:EUTRa:TCW:WS:CHBW on page 940

Cell ID

Sets the Cell ID.

See also [Chapter 4.6.3, "Cell-specific settings"](#), on page 229 .

Remote command:

[:SOURCE<hw>] :BB:EUTRa:TCW:WS:CLID on page 940

Cyclic Prefix

Selects normal or extended cyclic prefix.

Remote command:

[:SOURCE<hw>] :BB:EUTRa:TCW:WS:CYCPrefix on page 940

UE ID/n_RNTI

Sets the UE ID/n_RNTI.

Remote command:

[:SOURCE<hw>] :BB:EUTRa:TCW:WS:UEID on page 942

FRC

Displays the fixed reference channel used.

Remote command:

[:SOURCE<hw>] :BB:EUTRa:TCW:WS:FRC on page 940

Offset VRB

Sets the number of RB the allocated RB(s) are shifted with (see also [Example"Offset VRB"](#) on page 501).

Remote command:

[:SOURCE<hw>] :BB:EUTRa:TCW:WS:OVRB on page 941

Power Level

Displays the power level, depending on the selected test case.

Remote command:

[:SOURCE<hw>] :BB:EUTRa:TCW:WS:PLEVel? on page 941

7.6.5 Diagram

The graph displays the interference scenario defined by power level and frequency offset of the currently selected test case.

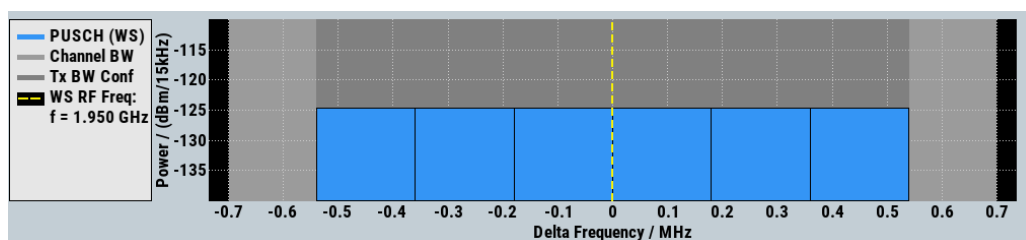

7.6.6 Apply settings

The "Apply" trigger a selective preset of the signal generator prior to presetting the setting according to the selected test case. Further modification of the generator settings is still possible. Signal generation starts with the first trigger event.

Use "Ok" to apply the settings and close the dialog.

Apply Settings

Activates the current settings of the test case wizard.

Note: The settings of the selected test case becomes active only after selecting "Apply Settings".

Initialization of the signal generator with the test case settings is performed by a partial selective reset that includes only the baseband, fading and AWGN module and the RF frequency and RF level settings. Other settings of the signal generator are not altered.

Before triggering the signal generator the user still can change these other settings. This is particularly useful when compensating for cable loss and additionally inserted attenuators by adjusting the RF power level offset is required.

Signal generation is started at the first trigger received by the generator. The RF output is not activated /deactivated by the test case wizard. Activate the "RF > State > On" at the beginning of the measurement.

Note: For safety reasons the RF is not active unless the button "RF ON" has been selected.

Note: The settings in the dialogs "EUTRA/LTE > Trigger/Marker/Clock" and in the "Global/Local Connector Settings" are not affected by the selective preset, if the parameter "Trigger/Marker Configuration" is set to "Unchanged".

Remote command:

`[:SOURce<hw>] :BB:EUTRa:TCW:APPLYsettings` on page 933

7.7 Transmitter characteristics (TS 36.141, chapter 6)

The transmitter characteristics comprise the maximum output power, output power dynamics, transmitted signal quality, unwanted emissions and transmitter intermodulations. The "Test Case Wizard" supports the generation of signals in accordance with the transmitter intermodulations test case. A brief description about the unwanted emission tests is also provided (see [Chapter 7.7.2, "Introduction to the unwanted emissions tests"](#), on page 509).

7.7.1 Prior considerations

Test Models

3GPP specifies EUTRA test models (E-TM) for testing the transmitter characteristic. For an overview, see "Test Models" on page 65.

Channels

According to the TS 36.141, the channels to test are located in the bottom (B), middle (M) and the top (T) of the supported frequency range of the base station. See Table 7-3 for an overview of the supported frequency operating bands.

Filter Settings

The 3GPP EUTRA/LTE specifications do not define a standardized transmit filter neither for the UE nor for the base station. Therefore, when a test case is activated, a filter type EUTRA/LTE with "Best ACP Optimization" is automatically selected.

Test Setup

Transmitter tests require a separate measuring equipment, e.g. the Vector Signal Analyzer R&S FSV.

7.7.2 Introduction to the unwanted emissions tests

The unwanted emissions from the transmitter are divided into two main groups, the out-of-band (OOB) emissions and the spurious emissions. The out-of-band emissions are emissions on frequencies close to the frequency of the wanted signal. Spurious emissions are emissions caused by unwanted transmitter effects, like harmonics, parasitic emissions, intermodulation products and frequency conversion products.

- ACLR
The Adjacent Channel Leakage power Ratio (ACLR) is defined as the ratio between the power transmitted in the channel bandwidth of the wanted signal to the power of the unwanted emissions transmitted on the adjacent channel. The test specification defines ACLR requirements for LTE and UTRA receivers. Different setting applies for paired and unpaired spectrum (see Table 7-4 and Table 7-5).

Table 7-4: Base Station ACLR in paired spectrum

EUTRA transmitted signal channel bandwidth BW_{Channel} , MHz	BS adjacent channel center frequency offset below the first or above the last carrier center frequency transmitted	Assumed adjacent channel carrier (informative)	Filter on the adjacent channel frequency and corresponding filter bandwidth	ACLR limit
1.4 / 3 / 5 / 10 / 15 / 20	BW_{Channel}	EUTRA of same BW	Square (BW_{Config})	44.2 dB
	$2x BW_{\text{Channel}}$	EUTRA of same BW	Square (BW_{Config})	

EUTRA transmitted signal channel bandwidth $BW_{Channel}$, MHz	BS adjacent channel center frequency offset below the first or above the last carrier center frequency transmitted	Assumed adjacent channel carrier (informative)	Filter on the adjacent channel frequency and corresponding filter bandwidth	ACLR limit
	$BW_{Channel}/2 + 2.5$ MHz	3.84 Mcps UTRA	RRC (3.84 Mcps)	
	$BW_{Channel}/2 + 7.5$ MHz	3.84 Mcps UTRA	RRC (3.84 Mcps)	

Table 7-5: Base Station ACLR in unpaired spectrum with synchronized operation

EUTRA transmitted signal channel bandwidth $BW_{Channel}$, MHz	BS adjacent channel center frequency offset below the first or above the last carrier center frequency transmitted	Assumed adjacent channel carrier (informative)	Filter on the adjacent channel frequency and corresponding filter bandwidth	ACLR limit
1.4 / 3	$BW_{Channel}$	EUTRA of same BW	Square (BW_{Config})	44.2 dB
	$2 \times BW_{Channel}$	EUTRA of same BW	Square (BW_{Config})	
	$BW_{Channel}/2 + 0.8$ MHz	1.28 Mcps UTRA	RRC (1.28 Mcps)	
	$BW_{Channel}/2 + 2.4$ MHz	1.28 Mcps UTRA	RRC (1.28 Mcps)	
5 / 10 / 15 / 20	$BW_{Channel}$	EUTRA of same BW	Square (BW_{Config})	44.2 dB
	$2 \times BW_{Channel}$	EUTRA of same BW	Square (BW_{Config})	
	$BW_{Channel}/2 + 0.8$ MHz	1.28 Mcps UTRA	RRC (1.28 Mcps)	
	$BW_{Channel}/2 + 2.4$ MHz	1.28 Mcps UTRA	RRC (1.28 Mcps)	
	$BW_{Channel}/2 + 2.5$ MHz	3.84 Mcps UTRA	RRC (3.84 Mcps)	
	$BW_{Channel}/2 + 7.5$ MHz	3.84 Mcps UTRA	RRC (3.84 Mcps)	
	$BW_{Channel}/2 + 5$ MHz	7.68 Mcps UTRA	RRC (7.68 Mcps)	
	$BW_{Channel}/2 + 15$ MHz	7.68 Mcps UTRA	RRC (7.68 Mcps)	

- Operating Band Unwanted Emissions
The 3GPP specification introduces the term operating band unwanted emissions instead of the spectrum mask. The operating band unwanted emissions requirements are defined from 10 MHz below the lowest frequency of the downlink **operating band** up to 10 MHz above the highest frequency of the operating band.

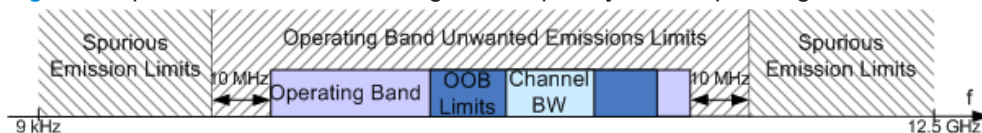

Figure 7-2: Transmitter tests frequency limits

The operating band unwanted emissions require a 100 kHz measurement bandwidth.

- Spurious Emissions

The transmitter spurious emissions limits apply from 9 kHz to 12.5 GHz, excluding the frequency range defined for the operating band unwanted emissions (see [Figure 7-2](#)).

Refer to [Table 7-6](#) for an overview of the general settings for the measurements. Additional requirements may apply for co-existence with other systems and/or co-location with other base stations. For detailed requirements, refer to the [TS 36.141](#).

Table 7-6: Spurious emissions

Frequency range	Maximum level Category A	Maximum level Category B	Measurement Bandwidth
9kHz - 150kHz	-13 dBm	-36 dBm	1 kHz
150kHz - 30MHz			10 kHz
30MHz - 1GHz			100 kHz
1GHz - 12.75 GHz		-30 dBm	1 MHz

7.7.3 General workflow for carrying out a transmitter test



The following describes the general workflow, only the basic steps are listed. For detailed description about working with the analyzer and the base station, refer to the corresponding description.

The basic test setup is illustrated on [Figure 7-3](#).

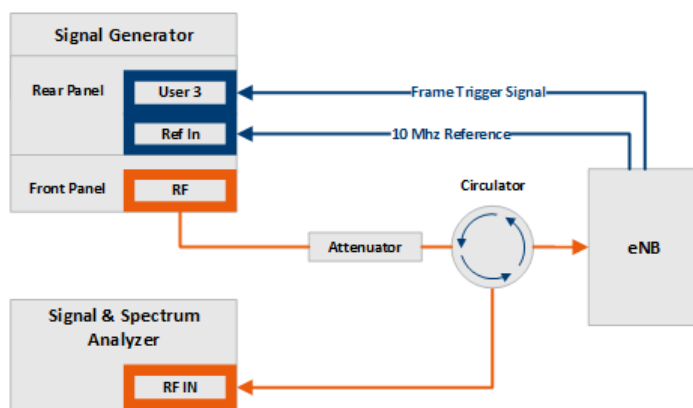

Figure 7-3: Test setup for Test case 6.7: Transmitter Intermodulation

1. Set the base station to the basic state and configure it for the selected test case.
 - a) Initialize the base station,
 - b) Set the base station to test model E-TM1.1,
 - c) Set maximum transmit power,
 - d) Set the frequency.
2. Set the signal generator to the basic state

- a) Preset the signal generator unless some settings (e.g. in terms of I/Q and RF blocks) have to be kept.
3. Set the analyzer to the basic state
4. Set the test case wizard
 - a) Select "Baseband Block > EUTRA/LTE > Test Case Wizard"
 - b) Select "Test Case 6.7: Transmitter Intermodulation".
The parameters are preset according to [TS 36.141](#)
 - c) Adjust the settings of the wanted signal (RF level and Channel Bandwidth).
 - d) Enter the test frequency (e.g. M). It must be the same as the base station has been set to.
 - e) Enter the Interfering Signal parameters.
 - f) Activate the settings with the "Apply Settings" button.
The signal generator is now ready to start signal generation
5. Set the analyzer to the measurement frequency and perform further necessary settings.
Refer to the description of the analyzer for further information.
6. In the signal generator, switch on the RF output.
7. Start the measurement
 - a) Send a start trigger impulse from the base station to the signal generator and to the analyzer.

The signal generator outputs the test model interfering signal; Measurement procedures are started.
8. Calculate the result
The analyzer calculates the out-of-band emission and the spurious emission.

7.7.4 Interfering signal settings

The following settings are common for the transmitter tests that require interfering signal (IS). Specific parameters are listed together with the description of the corresponding test case.

Test Case	Instrument	Frequency Allocation	BS Wanted Signal	Interfering Signal	
Offset to Channel Edge			2.5 MHz	RF Frequency	2.143 200 000 GHz
Duplexing			FDD	Channel Bandwidth	5 MHz
Test Model			E-TM1.1	Power Level	-60.00 dBm

The interfering signal is an E-TM1.1 signal with 5 MHz channel bandwidth and center frequency relative to the carrier frequency of the wanted signal.

Offset to Channel Edge

Defines the offset of the interfering signal center frequency relative to edge of the wanted channel bandwidth. This parameter determines the carrier frequency of the interfering signal (see [RF Frequency](#)).

Remote command:

[:SOURce<hw>] :BB:EUTRa:TCW:IS:OCEDge on page 937

RF Frequency

Displays the RF Frequency of the interfering signal, determined by the RF Frequency of the wanted signal and the selected [Offset to Channel Edge](#).

The RF Frequency_{interfering signal} is calculated as follows:

- For "Frequency Allocation > Interfering Signal > At Higher Frequencies"
"RF Frequency_{interfering signal}" = "RF Frequency_{wanted signal}" + Delta
- For "Frequency Allocation > Interfering Signal > At Lower Frequencies"
"RF Frequency_{interfering signal}" = "RF Frequency_{wanted signal}" - Delta

Where for both cases **Delta** is calculated as follows:

$$\text{Delta} = \text{BW}_{\text{wanted signal}}/2 + \text{Offset}_{\text{interfering signal}}$$

Example: Calculation of RF Frequency in Test Case 6.7

$$\text{BW}_{\text{wanted signal}} = 1.4 \text{ MHz}$$

$$\text{RF Frequency}_{\text{wanted signal}} = 1\,950 \text{ MHz}$$

$$\text{Offset}_{\text{interfering signal}} = 7.5 \text{ MHz}$$

$$\text{Delta} = 1.4/2 + 7.5 = 8.2 \text{ MHz}$$

For "Frequency Allocation > Interfering Signal > At Higher Frequencies": "RF Frequency_{interfering signal}" = 1 950 + 8.2 = 1 958.2 GHz

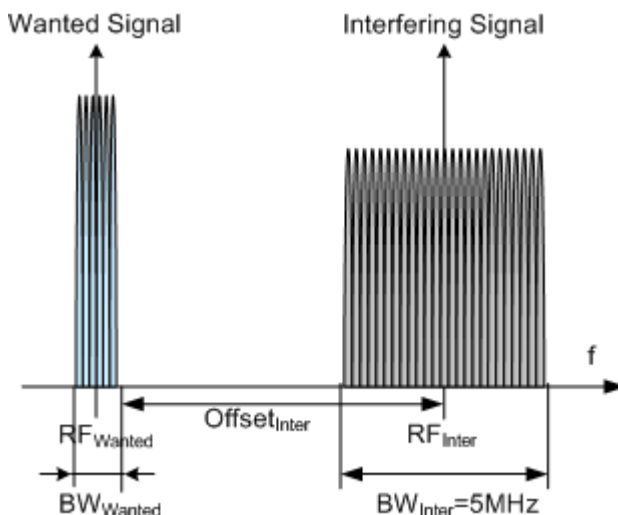

Figure 7-4: Example: Offset to Channel Edge (Channel Bandwidth = 1.4 MHz)

Remote command:

[:SOURce<hw>] :BB:EUTRa:TCW:IS:RFFrequency on page 938

Channel Bandwidth

Displays the channel bandwidth of the interfering signal.

Remote command:

[:SOURce<hw>] :BB:EUTRa:TCW:IS:CHBW? on page 936

Duplexing

Selects whether TDD or FDD duplexing mode is used.

Remote command:

[:SOURce<hw>] :BB:EUTRa:TCW:IS:DUPLex on page 936

Test Model

Displays the test model. The interfering signal is generated according to E-TM1.1 test model.

Remote command:

[:SOURce<hw>] :BB:EUTRa:TCW:IS:TMODe1? on page 939

Power Level/Power Level P-CPICH

Displays the power level of the interfering signal.

Test Case	Power level
6.7	The power level is always 30 dB below the Output Power Level of the wanted signal.

Remote command:

[:SOURce<hw>] :BB:EUTRa:TCW:IS:PLEVe1? on page 938

7.7.5 Test case 6.7: transmitter intermodulation**Test Purpose**

The test purpose is to verify the ability of the BS transmitter to restrict the generation of intermodulation products in its nonlinear elements caused by presence of the own wanted signal and an interfering signal reaching the transmitter via the antenna (TS 36.141).

Required Options**Test Setup**

See [Figure 7-3](#).

The [RF] output of the signal generator is connected to the analyzer via a circulator and external attenuator. The Tx signal of the base station is connected to the RF input of the analyzer via a circulator.

Short Description

The transmitter intermodulation test is intended to verify the ability of the BS transmitter to restrict the generation of intermodulation products in its nonlinear elements caused

by presence of wanted signal and an interfering signal reaching the transmitter via the antenna.

The BS transmits signals in accordance with E-TM1.1 at maximum power and with channel bandwidth BW_{Channel} corresponding to the maximum bandwidth supported by the base station. The interfering signal is an E-TM1.1 signal with 5 MHz channel bandwidth. The interfering signal power shall be 30 dB lower than the power of the wanted signal at the frequency offsets of ± 2.5 MHz, ± 7.5 MHz and ± 12.5 MHz.

The transmit intermodulation level shall not exceed the out-of-band emission requirements and transmitter spurious emissions requirements for all third and fifth order intermodulation products which appear in the frequency ranges defined in [Table 7-4](#), [Table 7-5](#) and [Table 7-6](#). For detailed information about the operating band unwanted emissions, refer to section 6.6.3.5 in [TS 36.141](#).

The test shall be done on three channels (B, M and T).

User Interface

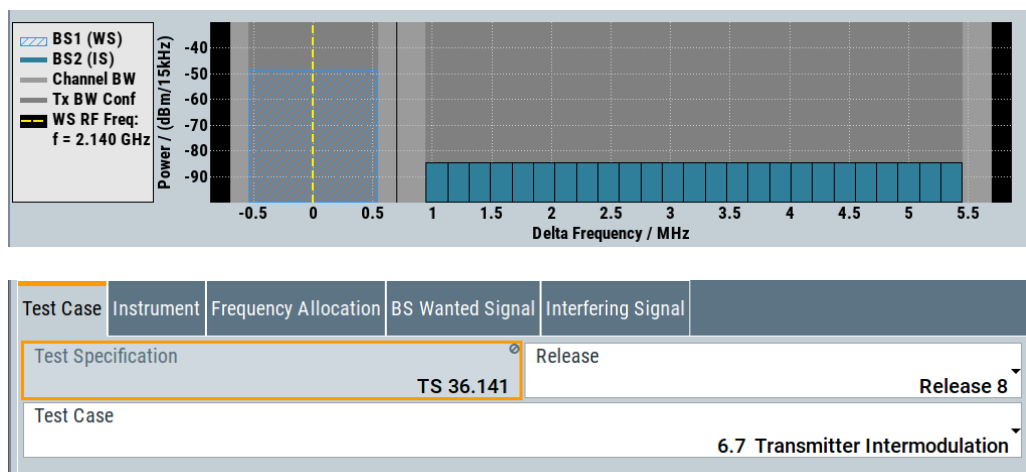

The settings of the interfering signal are described in [Chapter 7.7.4, "Interfering signal settings"](#), on page 512.

Base Station Wanted Signal

The common settings of the wanted signal are described in [Chapter 7.6.4, "Wanted signal and cell-specific settings"](#), on page 505.

Test Case	Instrument	Frequency Allocation	BS Wanted Signal	Interfering Signal
RF Frequency			2.140 000 000	GHz
			Channel Bandwidth	1.4 MHz
			Output Power Level	-30.00 dBm
TS 36.141: 6.7 Transmitter Intermodulation				<input type="button" value="Apply"/> <input type="button" value="OK"/>

Output Power Level ← Base Station Wanted Signal

Sets the output power level of the wanted signal. The power level of the interfering signal is always 30 dB lower than this level.

Remote command:

[:SOURce<hw>] :BB:EUTRa:TCW:WS:OUPLevel1 on page 941

7.8 Receiver characteristics (TS 36.141, chapter 7)

Most of the receiver tests can be performed with the signal generator only, i.e. without additional measurement equipment.

The receiver requirements are divided into the following main categories, intended to

- Prove the receiver's ability to receive the wanted signal:
 - Chapter 7.8.4, "Test case 7.2: reference sensitivity level", on page 522
 - Chapter 7.8.5, "Test case 7.3: dynamic range", on page 523
- Prove how susceptible the receiver is to different types of interfering signals:
 - Chapter 7.8.6, "Test case 7.4: in-channel selectivity (ICS)", on page 524

The several test cases shall cover a wide range of scenarios with different types of impairments on the wanted signal, that occur depending on the frequency offset between the wanted and the interfering signal.

7.8.1 Prior considerations

Fixed Reference Channels (FRC)

The receiver tests use fixed reference channels (FRC) as defined in TS 36.141, Annex A "Reference Measurement channels".

The following FRCs are defined for the receiver tests:

- FRC A1: A1-1 to A1-5 (QPSK)
- FRC A2: A2-1 to A2-3 (16QAM)



Refer to [Table 4-12](#) for an overview of all supported FRC.

Channels

According to the [TS 36.141](#), the channels to test are located in the bottom (B), middle (M) and the top (T) of the supported frequency range of the base station. See [Table 7-3](#) for an overview of the supported frequency operating bands.

Channel Bandwidth of the LTE Interfering Signal

For all test cases using an interfering LTE signal, the bandwidth of the interfering signal shall be the same as the wanted signal, but at the most 5 MHz.

Reference Sensitivity Power Level P_{REFSENS}

P_{REFSENS} depends on the channel bandwidth and the base station class as specified in [TS 36.104](#), subclause 7.2.1. The [Table 7-7](#) gives an overview of the resulting power levels for the wanted signal per test case.

Table 7-7: BS reference sensitivity levels

Channel Bandwidth, MHz	Base Station Class	Reference sensitivity power level, P_{REFSENS} , dBm	ACS Test Case Wanted signal mean power, dBm	Narrow-band Blocking/ Blocking/Receiver Intermodulation Test Case Wanted signal mean power, dBm
1.4	Wide Area BS	-106.8	-95.8	-100.8
	Local Area BS / Home Area BS	-98.8	-87.8	-92.8
	Medium Range BS	-101.8	-90.8	-95.8
3	Wide Area BS	-103.0	-95.0	-97.0
	Local Area BS / Home Area BS	-95.0	-87.0	-89.0
	Medium Range BS	-98.0	-90.0	-92.0
5 /10 /15 /20	Wide Area BS	-101.5	-95.5	-95.5
	Local Area BS / Home Area BS	-93.5	-87.5	-87.5
	Medium Range BS	-96.5	-90.5	-90.5

Power Settings

The "Level Reference" parameter in the "Filter/Clipping/Power Settings" dialog is automatically set to "Frame RMS Power" for FDD Duplexing Mode and to "UL Part of Frame RMS Power" for TDD Duplexing Mode.

Filter Settings

The 3GPP EUTRA/LTE specifications do not define a standardized transmit filter neither for the UE nor for the base station. Therefore, when a test case is activated, a filter type EUTRA/LTE with "Best EVM Optimization" is automatically selected.

7.8.2 General workflow for carrying out a receiver test

The following instruction lists the general steps for performing a BS conformance test with the help of "Test Case Wizard". Specific requirements are described together with the individual test case.



For detailed description about the configuration of the base station, refer to the corresponding description.

1. Connect the instrument and the DUT according to the corresponding test case setup.
See also [Chapter 7.4, "Standard test setups"](#), on page 498.
2. Set the base station to the basic state
 - a) Initialize the base station
 - b) Set the frequency
 - c) Set the base station to receive the Fixed Reference Channel (for most receiver test cases)
3. Preset the signal generator to ensure a defined instrument state.
4. Configure the test case wizard
 - a) Select "Baseband Block > EUTRA/LTE > Test Case Wizard".
 - b) Select a test case, e.g. "TS 36.141: 7.3 Dynamic Range".
 - c) Enter additional required parameters, e.g. power class of base station.
 - d) Enter the test frequency, e.g. M.
It must be the same as the base station has been set to.
 - e) Select "Apply Settings" to activate the settings.
The signal generator is now ready to start signal generation
5. Switch on RF output
6. If required, make additional settings (e.g. in the "I/Q Mod" or "RF" block) or change test case settings.
7. Start the measurement
 - a) Send a start trigger impulse from the base station to the signal generator.
The signal generator will start signal generation.
8. Calculate the result

The base station internally calculates the BER, BLER or Pd depending on the test case. This value is compared to the required value.

7.8.3 Interfering signal settings

The following settings are available for almost all receiver tests, requiring an interfering signal (IS). Specific parameters are listed together with the description of the corresponding test case.

Test Case	Instrument	Frequency Allocation	Wanted Signal	Interfering Signal 1	Interfering Signal 2
Interferer Type				Eutra	
Duplexing				FDD	
				RF Frequency	1.955 600 000 GHz
				Channel Bandwidth	1.4 MHz

Interferer Type

(enabled for Blocking and Receiver Intermodulation tests)

Selects the type of the interfering signal:

- For **Blocking** tests, the interfering signal can be an in-band EUTRA/LTE signal or out-of-band CW signal.
- For **Receiver Intermodulation** tests, the first interfering signal can be an EUTRA/LTE signal or narrow-band EUTRA signal.
The second interfering signal is always a CW signal.

Remote command:

[:SOURce<hw>] :BB:EUTRa:TCW:IS:IFTYpe on page 937

RF Frequency

Display the center frequency of the interfering signal.

The center frequency is calculated as follows:

- For "Frequency Allocation > Interfering Signal > At Higher Frequencies"
"RF Frequency_{interfering signal}" = "RF Frequency_{wanted signal}" + Delta
- For "Frequency Allocation > Interfering Signal > At Lower Frequencies"
"RF Frequency_{interfering signal}" = "RF Frequency_{wanted signal}" - Delta

Where for both cases Delta is calculated as follows:

Delta = "Channel Bandwidth_{wanted signal}" / 2 + Offset_{interfering signal}

See also "RF Frequency" on page 513.

Example:

"Channel Bandwidth_{wanted signal}" = 5 MHz

"RF Frequency_{wanted signal}" = 1 950 MHz

Offset_{interfering signal} = 2.5025 MHz

Delta = $5/2 + 2.5025 = 5.0025$ MHz

For "Frequency Allocation > Interfering Signal > At Higher Frequencies": "RF Frequency_{interfering signal}" = $1\,950 + 5.0025 = 1\,955.0025$ MHz

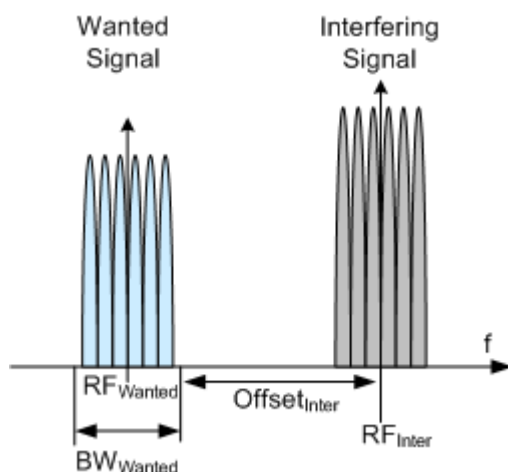

Figure 7-5: Example: Adjacent Channel Selectivity (ACS), Channel BW = 1.4 MHz

Remote command:

`[:SOURCE<hw>] :BB:EUTRa:TCW:IS:RFFrequency` on page 938

Duplexing

Selects whether TDD or FDD duplexing mode is used.

Remote command:

`[:SOURCE<hw>] :BB:EUTRa:TCW:IS:DUPLex` on page 936

TDD UL/DL Configuration

For TDD mode, selects the UL/DL Configuration number.

Remote command:

`[:SOURCE<hw>] :BB:EUTRa:TCW:IS:TDDConfig` on page 938

Signal Advance N_TA_offset

Sets the parameter $N_{TAoffset}$.

Remote command:

`[:SOURCE<hw>] :BB:EUTRa:TCW:IS:NTAOffset` on page 937

Channel Bandwidth

Displays the channel bandwidth of the interfering signal. The interfering signal has the same bandwidth as the wanted signal, but at the most 5 MHz.

Remote command:

[:SOURce<hw>] :BB:EUTRa:TCW:IS:CHBW? on page 936

Cell ID

Sets the Cell ID for the interfering signal.

Remote command:

[:SOURce<hw>] :BB:EUTRa:TCW:IS:CLID on page 936

UE ID/n_RNTI

Sets the UE ID/n_RNTI for the interfering signal.

Remote command:

[:SOURce<hw>] :BB:EUTRa:TCW:IS:UEID on page 939

Number of Resource Blocks

The number of RBs used by the LTE interfering signal is set automatically:

- For **ACS and In-channel Selectivity measurements**, the number of RBs depends on the selected channel bandwidth for the wanted signal. The bandwidth of the interfering signal is equal to the bandwidth allocated for the wanted signal, but at the most 5 MHz.
- For **Narrow-band Blocking** tests, the interfering signal is a single resource block LTE signal.

Remote command:

[:SOURce<hw>] :BB:EUTRa:TCW:IS:NRBLock? on page 937

Offset VRB

(Test Case 7.4 and 7.5 only)

The position of the RBs allocated by the LTE interfering signal is determined automatically, depending on the selected "Channel Bandwidth" and the RBs allocation of the wanted signal.

- For **in-channel testing**, the parameter "Offset VRB" is used to allocate the wanted and the interfering signal around the center frequency (see also [Figure 7-6](#)).
- For **ACS testing**, the "Offset VRB" is fixed to 0.
- For **narrow band blocking testing**, the "Offset VRB" is set in the way, that depending on the "Frequency Allocation" of the interfering signal, the narrow-band LTE interfering signal is allocated at the most left or the most right subcarrier in the allocated channel bandwidth

Remote command:

[:SOURce<hw>] :BB:EUTRa:TCW:IS:OVRB? on page 938

Power Level

The power level of the interfering LTE signal is set automatically depending on the selected channel bandwidth.

Remote command:

[:SOURce<hw>] :BB:EUTRa:TCW:IS:PLEVel? on page 938

7.8.4 Test case 7.2: reference sensitivity level

Test Purpose

To verify that at the BS Reference sensitivity level the throughput requirement shall be met for a specified reference measurement channel (TS 36.141).

Required Options

Test Setup

See Chapter 7.4.1, "Standard test setup - one path", on page 498

Short Description

The reference sensitivity level measurement is a test case that aims to verify the Noise Figure of the receivers. The test case uses FRCs with QPSK modulation.

The test shall be done on three channels (B, M and T). The selected "Channel Bandwidth" determines the used FRC and the "Wanted Signal Power Level". For channels larger than 5 MHz not all RBs are allocated; to adjust the position of the allocated RBs within the selected channel bandwidth, use the parameter "Offset VRB".

For the parameter in the Table 7-7 the throughput measured shall be equal or greater than 95%.

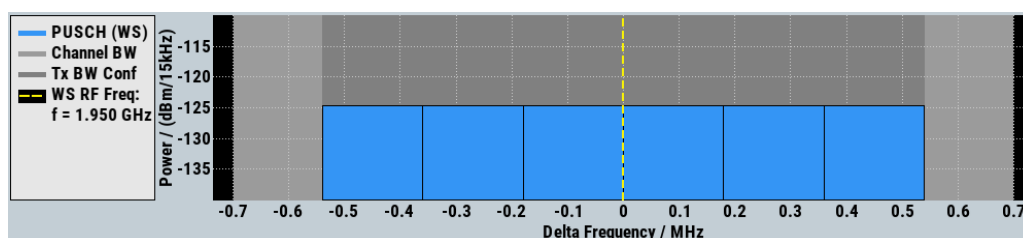

Test Case	Instrument	Wanted Signal
Test Specification	TS 36.141	Release 8
Test Case		7.2 Reference Sensitivity Level

Test Case	Instrument	Wanted Signal
RF Frequency	1.950 000 000 GHz	Duplexing: FDD
Channel Bandwidth	1.4 MHz	Cell ID: 150
UE ID / n_RNTI	1	
FRC	A1-1	Offset VRB: 0
Power Level		

The settings of the wanted signal are described in [Chapter 7.6.4, "Wanted signal and cell-specific settings"](#), on page 505.

7.8.5 Test case 7.3: dynamic range

Test Purpose

To verify that at the BS receiver dynamic range, the relative throughput shall fulfil the specified limit ([TS 36.141](#)).

Required Options

Test Setup

See [Chapter 7.4.1, "Standard test setup - one path"](#), on page 498

Short Description

The dynamic range test case aims to stress the receiver and measure its capability to demodulate the useful signal even in the presence of a heavy interfering signal inside the received channel bandwidth. The test case uses FRCs with 16QAM modulation. The throughput measurements are performed for different level of the wanted and the interfering AWGN signals.

The test shall be done on three channels (B, M and T). The selected "Channel Bandwidth" determines the used FRC and the "Wanted Signal Power Level". For channels larger than 5 MHz not all RBs are allocated; to adjust the position of the allocated RBs within the selected channel bandwidth, use the parameter "Offset VRB".

For the parameter in the [Table 7-8](#) the throughput shall be equal or greater than 95%.

Table 7-8: Dynamic range (Wide Area BS)

Channel Bandwidth, MHz	Reference Measurements Channel	Wanted signal mean power, dBm	Interfering signal mean power, dBm / BW _{Config}	Type of interfering signal
1.4	FRC A2-1	-76.0	-88.7	AWGN
3	FRC A2-2	-72.1	-84.7	AWGN
5	FRC A2-3	-69.9	-82.5	AWGN
10	FRC A2-3	-69.9	-79.5	AWGN
15	FRC A2-3	-69.9	-77.7	AWGN
20	FRC A2-3	-69.9	-76.4	AWGN

For the parameters of the other base station classes (Local Area BS, Home BS and Medium Range BS), refer to [TS 36.141](#).

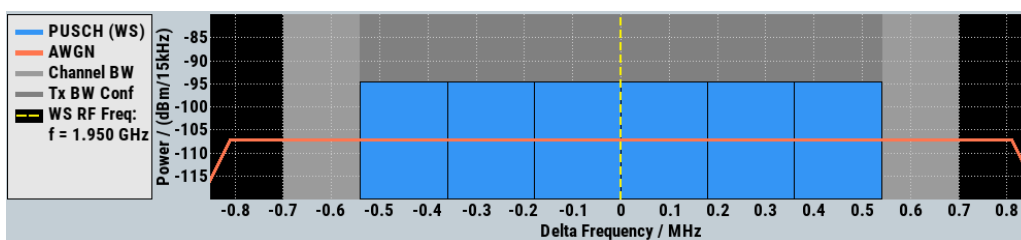

Test Case	Instrument	Wanted Signal	AWGN
Test Specification		TS 36.141	Release 8
Test Case		7.3 Dynamic Range	

Test Case	Instrument	Wanted Signal	AWGN
RF Frequency		1.950 000 000 GHz	Duplexing: FDD
Channel Bandwidth		1.4 MHz	Cell ID: 150
UE ID / n_RNTI		1	
FRC		A2-1	Offset VRB: 0
Power Level			

The settings of the wanted signal are described in [Chapter 7.6.4, "Wanted signal and cell-specific settings"](#), on page 505.

AWGN Configuration

Comprises the settings of the interfering signal.

Test Case	Instrument	Wanted Signal	AWGN
Power Level		-88.70 dBm (within 1.08 MHz BW)	

Power Level ← AWGN Configuration

Displays the power level of the AWGN signal. The value is set automatically according to [Table 7-8](#) and depending on the selected [Channel Bandwidth](#).

Remote command:

[:SOURce<hw>] :BB:EUTRa:TCW:AWGN:PLEVel? on page 934

7.8.6 Test case 7.4: in-channel selectivity (ICS)

Test Purpose

The purpose of this test is to verify the BS receiver ability to suppress the IQ leakage (TS 36.141).

Required Options

Test Setup

See [Chapter 7.4.1, "Standard test setup - one path"](#), on page 498.

Short Description

In-channel selectivity (ICS) is a measure of the receiver ability to receive a "weak" wanted signal at its assigned Resource Block locations in the presence of a "strong" interfering signal. The interfering signal shall be an EUTRA/LTE signal with the same bandwidth as the wanted signal, but at the most 5 MHz. The wanted and the interfering signal are allocated around the center frequency (see [Figure 7-6](#)); to swap the position of the wanted and interfering signal, use the parameter "Frequency Allocation".

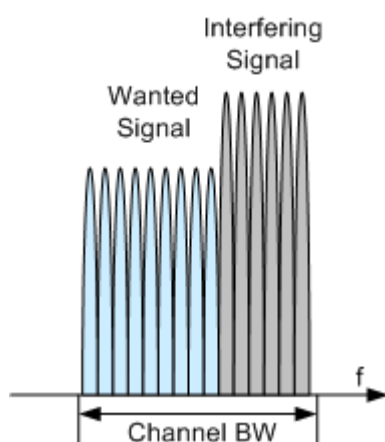

Figure 7-6: Example: In-channel selectivity (ICS), Channel BW = 3 MHz, Frequency Allocation = Lower Frequency

In a one-path instrument, the wanted and the interfering LTE signals are both generated using the same path. The interfering signal is simulated as an additional user equipment (UE). The level difference between the wanted and the interfering signals is handled in the baseband. As the interferer level is higher, it is used as a reference; the level of the wanted signal is set relatively lower to the interferer.

The test shall be done on three channels (B, M and T). The selected "Channel Bandwidth" determines the used FRC and the "Wanted Signal Power Level". For channels larger than 5 MHz not all RBs are allocated; to adjust the position of the allocated RBs within the selected channel bandwidth, use the parameter "Offset VRB".

For the parameter in the [Table 7-9](#) the throughput shall be equal or greater than 95%.

Table 7-9: In-channel selectivity (Wide Area BS)

Channel Bandwidth, MHz	Reference Measurements Channel	Wanted signal mean power, dBm	Interfering signal mean power, dBm / BW_{Config}	Type of interfering signal
1.4	FRC A1-4	-105.5	-87	1.4 MHz EUTRA signal, 3 RBs
3	FRC A1-5	-100.7	-84	3 MHz EUTRA signal, 6 RBs

Channel Bandwidth, MHz	Reference Measurements Channel	Wanted signal mean power, dBm	Interfering signal mean power, dBm / BW _{Config}	Type of interfering signal
5	FRC A1-2	-98.6	-81	5 MHz EUTRA signal, 10 RBs
10	FRC A1-3	-97.1	-77	10 MHz EUTRA signal, 25 RBs
15	FRC A1-3	-97.1	-77	15 MHz EUTRA signal, 25 RBs [*]
20	FRC A1-3	-97.1	-77	20 MHz EUTRA signal, 25 RBs [*]

^{*}) Wanted and interfering signal are placed adjacently around the carrier frequency

For the parameters of the other base station classes (Local Area BS, Home BS and Medium Range BS), refer to TS 36.141.

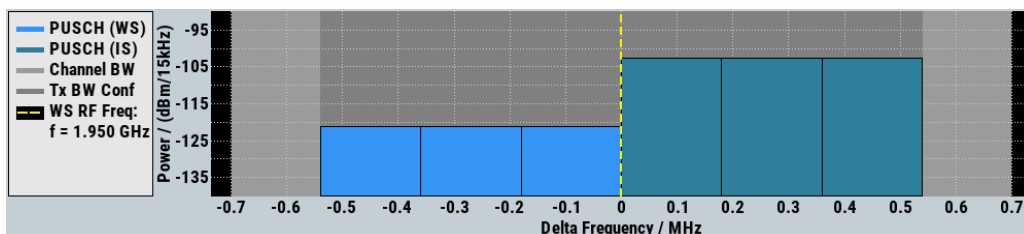

Test Case	Instrument	Frequency Allocation	Cell-specific	Wanted Signal	Interfering Signal
Test Specification			TS 36.141	Release	Release 8
Test Case					7.4 In Channel Selectivity

Test Case	Instrument	Frequency Allocation	Cell-specific	Wanted Signal	Interfering Signal
Interfering Signal					At Higher Resource Blocks

Test Case	Instrument	Frequency Allocation	Cell-specific	Wanted Signal	Interfering Signal
RF Frequency		1.950 000 000 GHz		Duplexing	FDD
Channel Bandwidth		1.4 MHz		Cell ID	150

Test Case	Instrument	Frequency Allocation	Cell-specific	Wanted Signal	Interfering Signal
UE ID / n_RNTI				1	
FRC			A1-4	Offset VRB	0
Power Level					-105.50 dBm

Test Case	Instrument	Frequency Allocation	Cell-specific	Wanted Signal	Interfering Signal		
UE ID / n_RNTI				2	Number of Resource Blocks		3
Offset VRB				3	Power Level		-87.00 dBm

The cell-specific settings and the settings of the wanted signal are described in [Chapter 7.6.4, "Wanted signal and cell-specific settings"](#), on page 505.

Refer to [Chapter 7.8.3, "Interfering signal settings"](#), on page 519 for description of the corresponding settings.

8 Generating user plane data

If equipped with the option R&S SMM-K175, your R&S SMM100A can generate and export user plane (U-plane) data based on the O-RAN specifications.

The O-RAN alliance defines a standardized data format for 3GPP signals. Data is exported into a set of `.json` files which contains the raw frequency domain I/Q-samples.

The `.json` files can be parsed into a file format that you use for postprocessing.

For detailed information about the specifications, refer to the documents of the O-RAN alliance.

Access to U-plane data generation

You can activate U-plane data generation in the "General Settings" dialog. For details, see "[U-Plane Generation](#)" on page 68.

To select one of the predefined configurations via O-RAN test models, refer to "[Test Models](#)" on page 65

Note that U-plane data generation slows down the calculation speed of the instrument. Therefore, turn on U-plane data generation only if necessary.

8.1 Required options

The generation of U-plane data requires:

- Standard or wideband baseband generator (R&S SMM-B10/-B9)
- Baseband main module (R&S SMM-B13) or wideband baseband main module (R&S SMM-B13XT)
- Digital standard EUTRA/LTE releases 13/14/15 (R&S SMM--K119) or
- Digital standard NB-IoT release 15/16/17 (R&S SMM-K146)
- Option U-plane data generation (R&S SMM-K175)

8.2 File format and folder structure

When exporting the user plane, the R&S SMM100A stores the data in the `\user\U-Plane\` directory on its harddisk. A U-plane dataset itself consists of a set of subdirectories.

```
\Output_0
  \Carrier_0
  \Carrier_1
  \Carrier_N
  \Output_1
```

...
\Output_N

Every folder contains a set of `n` `.json` files (`SF_<xx>.json`), where $n = 10 * \text{No_of_rf_frames}$. The number of values in the file depends on the number of symbols. This number depends on the number of FFT samples:

number of I/Q values = number of symbols * FFT samples

- I/Q values within a symbol are separated by a comma
- The end of a symbol is indicated by a new line character (`\n`)

Example:

```
0+0j,0+0j,0+0j,0+0j,0+0j,0+0j,0+0j,0+0j,0+0j,0+0j,0+0j,0+0j,  
0+0j,0+0j\n
```

Note that the R&S SMM100A always generates a complete set of data, even for symbols that are not allocated. Those I/Q data have the value 0 ("0+0j"), while the I/Q data for symbols that are allocated have the actual real and imaginary values (e.g. "-0.707106781+0.707106781j").

9 Signal control and signal characteristics

This section lists settings provided for improving the signal and spectrum characteristics of the generated signal, defining the signal power and the signal generation start.

It covers the following topics:

- [Time domain windowing settings](#)..... 530
- [Filter/clipping/ARB settings](#)..... 531
- [Adjusting the signal power](#)..... 539
- [Trigger settings](#)..... 544
- [Marker settings](#)..... 550
- [Clock settings](#)..... 552
- [Local and global connectors settings](#)..... 553

9.1 Time domain windowing settings

Access:

- ▶ Select "Filter/Clipping/ARB/TDW/Power > Time Domain Windowing".

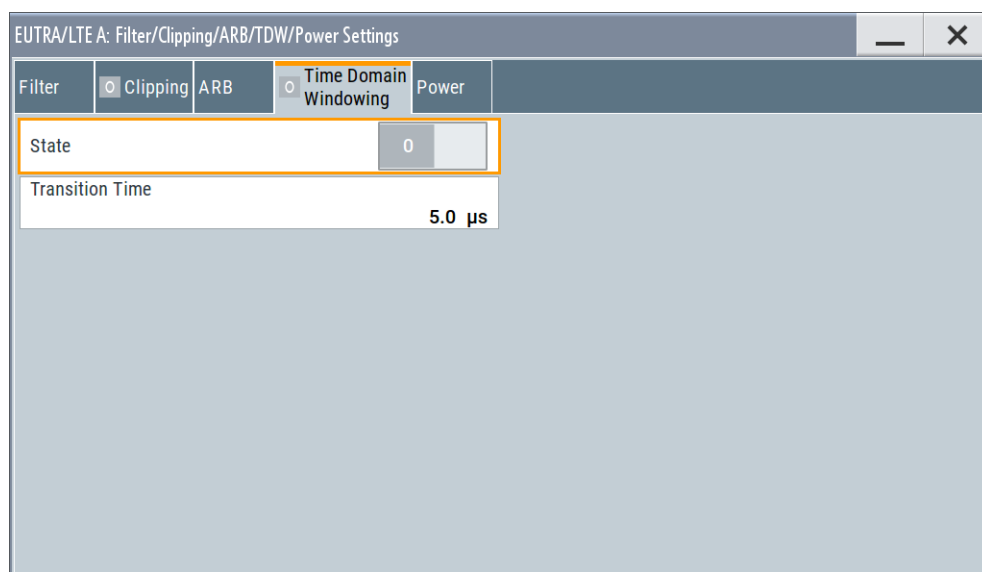

This dialog comprises the settings required for configuring the time domain windowing.

Settings:

- [State](#)..... 530
- [Transition Time](#)..... 531

State

Activates/deactivates the time domain windowing.

Time domain windowing is a method that influences the spectral characteristics of the signal. The method removes the spikes caused by the OFDM; it does not replace over-sampling and subsequent signal filtering.

Time domain windowing is not stipulated by the 3GPP standard.

Remote command:

[:SOURce<hw>] :BB:EUTRa:TDW:STATe on page 566

Transition Time

Sets the transition time when time domain windowing is active.

The transition time defines the overlap range of two OFDM symbols. At a setting of 1 us and if sample rate = 15.36 MHz, 15 samples overlap.

Remote command:

[:SOURce<hw>] :BB:EUTRa:TDW:TRTime on page 566

9.2 Filter/clipping/ARB settings

Access:

- ▶ Select "EUTRA/LTE > General > Filter/Clipping/ARB/TDW/Power Settings".

The dialog comprises the settings, for enabling time domain windowing and clipping, and adjusting the filter and power settings.

9.2.1 Filter settings

Access:

- ▶ Select "Filter/Clipping/ARB/TDW/Power > Filter".

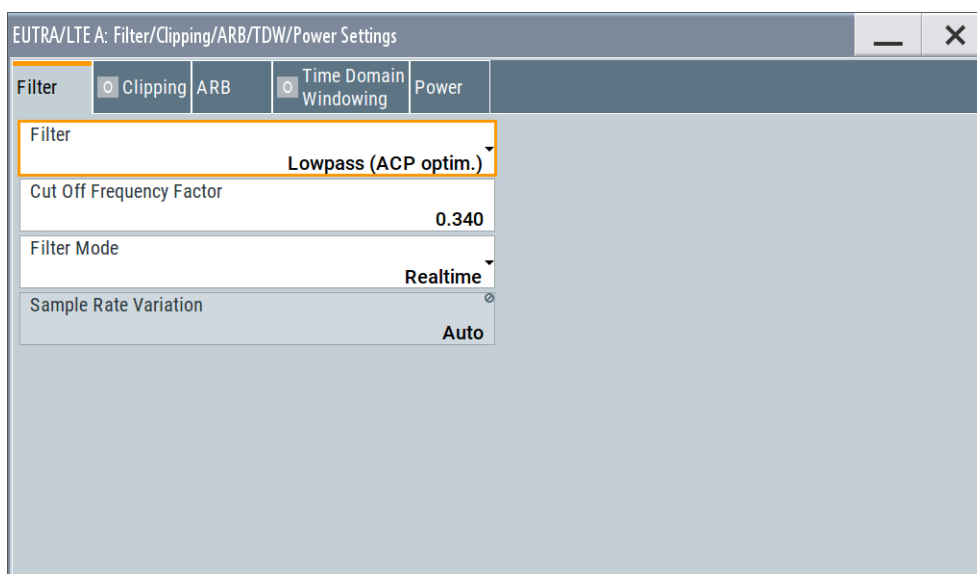

This dialog comprises the settings required for configuring the baseband filter.

Provided are the following settings for configuring the baseband filter:

Filter.....	532
Optimization.....	532
Load User Filter.....	533
Rolloff factor or BxT.....	534
Cutoff frequency shift.....	535
Cutoff Frequency Factor.....	536
Filter Mode.....	536
Sample Rate Variation.....	536

Filter

Sets the baseband filter.

Remote command:

[:SOURce<hw>] :BB:EUTRa:FILTer:TYPE on page 561

Optimization

Selects one of the provided EUTRA/LTE filters.

Each filter is designed for different application field and optimized for a particular performance. Depending on the filter implementation, these filters require different calculation time. The applied upsampling factor also influences the size of the calculated output waveform file.

Waveforms can be calculated in the following ways:

- With the "Generate Waveform File" function
- With the signal generation software R&S WinIQSIM2

The following table outlines the difference between the provided EUTRA/LTE filters by comparing their major specifications.

Table 9-1: Overview of the EUTRA/LTE filters

Characteristic	"Best EVM"	"Best ACP" "Best ACP (Narrow)"	"Best EVM (no upsampling)"
Design goal	An excellent EVM performance while ignoring the effects on ACP	A combination of an excellent ACP performance and a good EVM performance "Best ACP (Narrow)" features also a smoother shape in frequency domain	A combination of an excellent ACP performance and a good EVM performance Small output waveform file size
Calculation time (in real-time processing)	By real-time processing, short calculation time	Long calculation time: the filtered signal is precalculated because of the filter complexity	Long calculation time: the filtered signal is precalculated because of the filter complexity
Upsampling	Upsampling with factor 2 The sample rate of the output waveform is twice the LTE sample rate	Upsampling with factor 2 The sample rate of the output waveform is twice the LTE sample rate The signal processing requires twice as much internal memory. The available memory on the instrument is sufficient for the simulation of half as many frames compared to filter "Best EVM"	Upsampling is not applied The sample rate of the output waveform is not changed
Output waveform file size	Increased file size	Increased file size	File size is maintained The resulting file size is smaller than in the other cases
Recommended application field	Receiver and performance tests with internal real-time generation, where BLER is analyzed	Transmitter and components tests where excellent ACP is required	Receiver and performance tests with pre-generated waveform files, where BLER is analyzed

In specific configurations, an internal ("Auto") filter is applied automatically. This filter is designed for best possible optimization in configurations, like the carrier aggregation with carriers that span different bandwidths.

Remote command:

`[:SOURCE<hw>] :BB:EUTRa:FiLTeR:PARAmeter:LTE:OPTimization`

on page 563

`[:SOURCE<hw>] :BB:EUTRa:FiLTeR:AUTO?` on page 563

Load User Filter

If **Filter** > "User" is selected, it opens the standard dialog "Select List File User Filter" for loading a user-defined filter file.

User filters are used as offline filters. The following types are supported:

- Files with predefined file format and extensions `VAF`
For information, refer to the description "Introduction to "filtwiz" Filter Editor" on the Rohde & Schwarz web page.
- ASCII files with simple format and file extension `DAT`
These files describe filters as a sequence of normalized filter coefficients. Each coefficient is defined as a pair of I and Q samples. The I and Q components alternate at each file line. The I and Q values vary between - 1 and + 1.
A user filter can contain up to 2560 coefficients.
The user filter must be real-valued. For both I and Q components of the coefficients, only real coefficients different than 0 are allowed.

You can create user filter files for example with MATLAB, see [Example "Script that generates user filter file"](#) on page 534.

Example: Script that generates user filter file

This MATLAB script creates a user filter file that fits the LTE default settings: "Channel Bandwidth = 10 MHz", "Number of Resource Blocks = 50", "FFT Size = 1024".

```
n_fft = 1048; %10MHz
n_scs = 50*12; %50RBs*12 subcarriers per RB

trans_region = 0.02 * n_fft/2; %in %, controls steepness of filter slopes,
relative to nyquist frequency

%cutoff frequencies
f = [n_scs/2 n_scs/2+trans_region];

%ripples in dB
rp = 0.01; %passband
rs = 80; %stopband
dev = [(10^(rp/20)-1)/(10^(rp/20)+1) 10^(-rs/20)];

%estimate filter order
[n,fo,ao,w] = firpmord(f,[1 0],dev,n_fft);

%generate filter coefficients
b = firpm(n,fo,ao,w);

fvtool(b); %displays filter response

%write filter out into .dat filter coefficient file
coeffs_out = zeros(2*length(b),1);
coeffs_out(1:2:end) = real(b);
coeffs_out(2:2:end) = imag(b);

dlmwrite(['smw_user_filter_' num2str(n) 'coeffs_' num2str(n_scs)
'scs_' num2str(n_fft) 'fft.dat'],coeffs_out);
```

Remote command:

[\[:SOURCE<hw>\]:BB:EUTRa:FILTER:PARAMeter:USER](#) on page 564

Rolloff factor or BxT

Sets the filter parameter.

The rolloff factor affects the steepness of the filter slopes. A "Rolloff Factor = 0" results in the steepest slopes; values near to 1 make the slopes more flat.

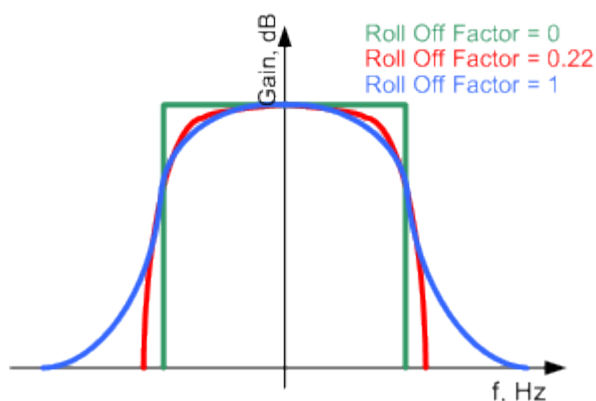

Figure 9-1: Example of the frequency response of a filter with different rolloff factors

For the default cosine filter, a rolloff factor of 0.10 is used.

Remote command:

[:SOURce<hw>] :BB:EUTRa:FiLTer:PARAmeter:COSSine on page 562

[:SOURce<hw>] :BB:EUTRa:FiLTer:PARAmeter:RCOSSine on page 562

[:SOURce<hw>] :BB:EUTRa:FiLTer:PARAmeter:PGAuss on page 562

[:SOURce<hw>] :BB:EUTRa:FiLTer:PARAmeter:GAUSSs on page 562

[:SOURce<hw>] :BB:EUTRa:FiLTer:PARAmeter:SPHase on page 562

[:SOURce<hw>] :BB:EUTRa:FiLTer:PARAmeter:APCO25 on page 562

[:SOURce<hw>] :BB:EUTRa:FiLTer:PARAmeter:LTE:ROFactor on page 563

Cutoff frequency shift

(available for filter parameter cosine and EUTRA/LTE with EVM optimization only)

The cutoff frequency is a filter characteristic that defines the frequency at the 3 dB down point. The "Cut Off Frequency Shift" affects this frequency in the way that the filter flanks are "moved" and the transition band increases by "Cut Off Frequency Shift" * "Sample Rate".

- A "Cut Off Frequency Shift" = -1 results in a very narrow-band filter
- Increasing the value up to 1 makes the filter more broad-band
- By "Cut Off Frequency Shift" = 0, the -3 dB point is at the frequency determined by the half of the selected "Sample Rate".

Tip: Use this parameter to adjust the cutoff frequency and reach spectrum mask requirements.

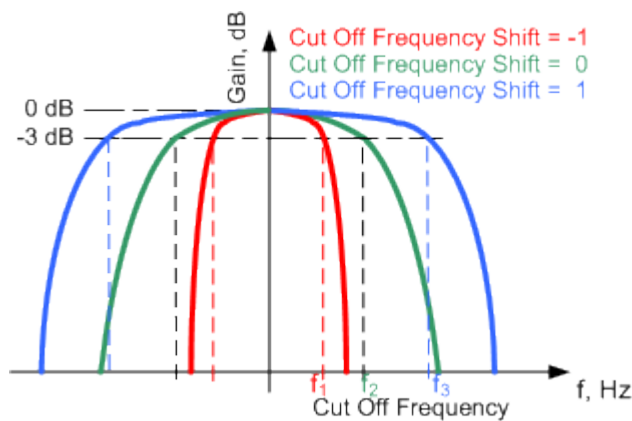

Figure 9-2: Example of the frequency response of a filter with different cutoff frequency shift

Example:

"Channel Bandwidth" = 10 MHz

"Sample Rate" = 15.36 MHz

"Cutoff frequency shift" = 0

Frequency at 3 dB down point = +/- 7.68 MHz

Remote command:

`[:SOURce<hw>] :BB:EUTRa:FiLTer:PARAmeter:COsine:COFS` on page 562

`[:SOURce<hw>] :BB:EUTRa:FiLTer:PARAmeter:LTE:COFS` on page 562

Cutoff Frequency Factor

(available for filter parameter lowpass and EUTRA/LTE with ACP optimization only)

Sets the value for the cutoff frequency factor.

The cutoff frequency of the filter can be adjusted to reach spectrum mask requirements.

Remote command:

`[:SOURce<hw>] :BB:EUTRa:FiLTer:PARAmeter:LPASs` on page 562

`[:SOURce<hw>] :BB:EUTRa:FiLTer:PARAmeter:LTE:COFFactor` on page 563

`[:SOURce<hw>] :BB:EUTRa:FiLTer:PARAmeter:LPASSEVM` on page 562

Filter Mode

Selects an offline or real-time filter mode.

Remote command:

`[:SOURce<hw>] :BB:EUTRa:FiLTer:MODE` on page 561

Sample Rate Variation

Sets the sample rate of the signal. A variation of this parameter affects the ARB clock rate; all other signal parameters remain unchanged.

The value of this parameter is set according to the current physical settings, like the channel bandwidth.

For certain configurations of carrier aggregation (like different channel BW in the carriers), the sample rate is set to a fixed value ("Auto") and cannot be changed.

Remote command:

[\[:SOURCE<hw>\]:BB:EUTRa:SRATe:VARiation](#) on page 564

9.2.2 Clipping settings

Access:

- ▶ Select "Filter/Clipping/ARB/TDW/Power > Clipping".

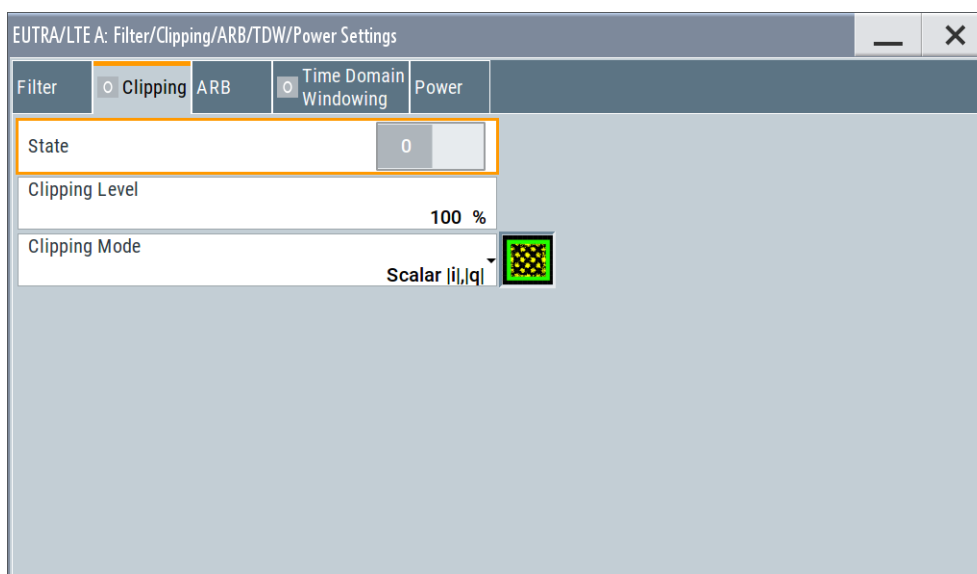

This dialog comprises the settings required for configuring the clipping.

Settings:

Clipping State	537
Clipping Level	537
Clipping Mode	538

Clipping State

Switches baseband clipping on and off.

Baseband clipping is a simple and effective way of reducing the crest factor of the signal. Since clipping is done before to filtering, the procedure does not influence the spectrum. The EVM however increases.

Remote command:

[\[:SOURCE<hw>\]:BB:EUTRa:CLIPping:STATe](#) on page 565

Clipping Level

Sets the limit for clipping.

This value indicates at what point the signal is clipped. It is specified as a percentage, relative to the highest level. 100% indicates that clipping does not take place.

Remote command:

[:SOURce<hw>] :BB:EUTRa:CLIPping:LEVel on page 565

Clipping Mode

Selects the clipping method. The dialog displays a graphical illustration on how this two methods work.

- "Vector $|i + jq|$ "
The limit is related to the amplitude $|i + q|$. The I and Q components are mapped together, the angle is retained.
- "Scalar $|i|, |q|$ "
The limit is related to the absolute maximum of all the I and Q values $|i| + |q|$. The I and Q components are mapped separately, the angle changes.

Selects the clipping method. A graphic illustrates how the two methods work.

Remote command:

[:SOURce<hw>] :BB:EUTRa:CLIPping:MODE on page 565

9.2.3 ARB settings

Access:

- ▶ Select "Filter/Clipping/ARB/TDW/Power > ARB".

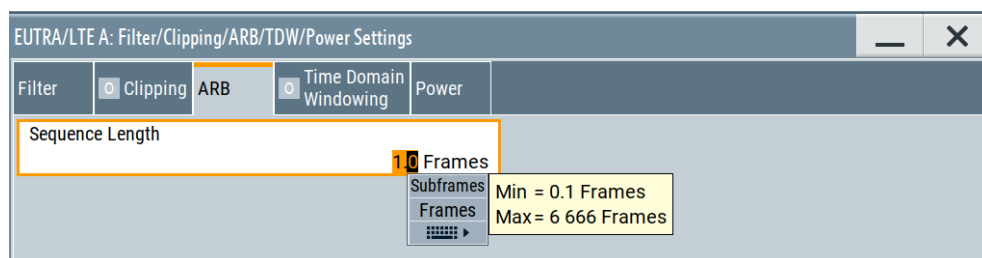

This dialog comprises the settings required for configuring the arbitrary waveform.

Settings:

(Current) Sequence Length

Sets the sequence length of the signal.

- The sequence length is set per default in number of frames. One frame corresponds to 10 ms. The signal is calculated in advance and output in the arbitrary waveform generator. The maximum number of frames is calculated as follows:
Max. no. of frames = ARB waveform memory size / ("Sampling Rate" x 10 ms).
- You can also select unit subframes.
Note that for the sequence length in number of subframes is not supported in combination with the following features:
 - eMTC / NB-LoT
 - LAA (frame structure type 3)
 - "SFN Restart Period" = 3GPP (1024 Frames)
 - Time domain windowing

- "Power Reference" different from *Frame RMS Power*, *UL Part of Frame RMS Power*, and *DL Part of Frame RMS Power*
- Uplink real-time feedback (for BTS conformance tests)

Remote command:

[:SOURce<hw>] :BB:EUTRa:SLENgth on page 559

[:SOURce<hw>] :BB:EUTRa:SUSLen on page 559

9.3 Adjusting the signal power

The R&S SMM100A equipped with option EUTRA/LTE (R&S SMM-K55) provides several possibilities to adjust the power level of the generated LTE signal. It also provides settings to adjust the relations between the power levels of the channels and signals in the LTE signal itself.

9.3.1 General power-related settings overview

The general power settings are as follows:

- Output level (P_{out}) of the instrument
To adjust the value, select "Status bar > Level".

9.3.2 Downlink power-related settings overview

In downlink direction, the value displayed in the "Level" display defines the RMS level of the output signal calculated upon several frames.

- FDD duplexing mode
The displayed RMS and the PEP values are valid for the whole frame.
- TDD duplexing mode
The calculation is based only on the downlink parts of the frame, i.e. the DL sub-frames and the DwPTS.
(See also parameter [Power Reference](#)).

Additionally to the general power settings, the following settings are influencing the power of the output signal in downlink direction:

- [Downlink Reference Signal Structure](#)
- [Synchronization Signal Settings](#)
- [PBCH Power and PDSCH Power](#)
- [PCFICH settings, PHICH settings, \(E\)PDCCH settings](#)
- [Cell-specific settings](#)
- [NRS/N-SYNC \(NPSS/NSSS\)](#)
- [NPBCH, NPDCCH and NPDSCH settings](#)

All DL power configurations are set relative to each other. The absolute power level of one resource element during one subframe depends on the configuration during the remaining subframes.

Example:

If:

- PDCCH power = 2 dB
- For a particular PDSCH, PDSCH power = -3 dB

The power level of the PDCCH subcarriers is with 5 dB higher than the power level of the PDSCH subcarriers.

The basis for the calculation of the absolute power level of the channels and the signals in DL direction is the **power of one reference signal resource element**. The value is displayed with the parameter "General DL Settings" > "Downlink Signals" > [Reference Signal Power](#). Use this parameter to configure specific absolute power of one RS subcarrier, like for example to set a required SNR defined for a 15kHz sub-band.

Example:

- Select "EUTRA/LTE > Set to Default".
- "Level = - 30 dB"
- "RS Power per RE relative to Level Display = - 27.78 dB"
- Select "PDSCH power = - 3 dB"

The absolute power level of one single reference signal (RS) subcarrier is -57.78 dBm.

The absolute power level of a PDSCH subcarrier calculated based on the absolute power level of a single RS is -60.78 dBm.

9.3.3 Uplink power-related settings overview

Additionally to the general power settings listed in [General power-related settings overview](#), the following settings are influencing the power of the output signal in uplink direction:

- Power reference
- Power factors for PUSCH/PUCCH/PRACH/SRS
- DRMS Power Offset (available for PUSCH and PUCCH)
- UE Power

While generating an uplink signal, the power displayed in the "Level" display defines the current RMS level at the output. The RMS and PEP values however are calculated based upon different parts of the signal, depending on the value of the parameter [Power Reference](#)

- "Power Reference" = "Frame RMS Power" (UL FDD) or "UL Part of Frame RMS Power" (UL TDD)
In the FDD duplexing mode, the displayed RMS and the PEP values ("Level" and "PEP") are valid for the whole frame. In TDD duplexing mode, the calculation is based only on the uplink parts of the frame, i.e. the UL subframes and the UpPTS.

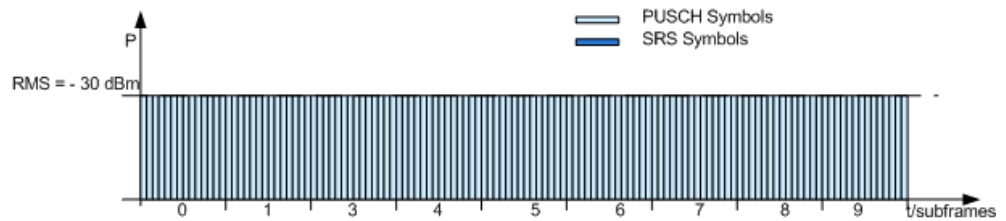

Note: The absolute power of a single subframe depends also on the signal within of the remaining subframes.

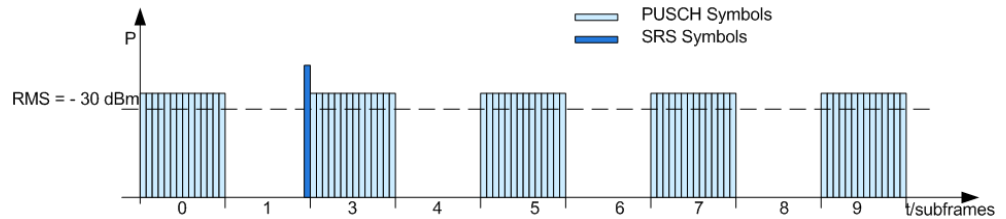

- "Power Reference" = "UE Burst RMS Power" (UL FDD and UL TDD)
The displayed "Level" and "PEP" values are measured only for a certain burst of a single UE. See the description of the parameter [Power Reference](#) for description of the decision algorithm and how the reference bursts are selected.

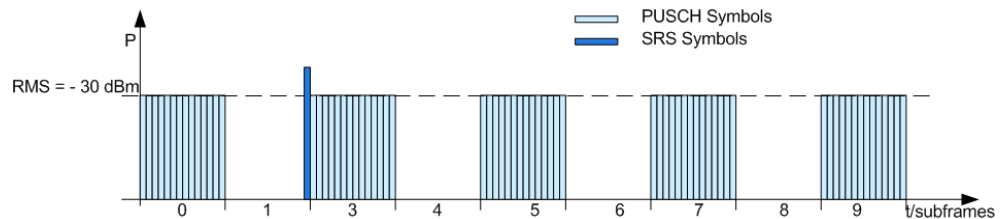

Use this mode to simplify the configuration of the SNR required for the test cases defined in [TS 36.141](#), in case the PUSCH is not transmitted in every subframe.

9.3.4 Power settings

Access:

- ▶ Select "Filter/Clipping/ARB/TDW/Power > Power".

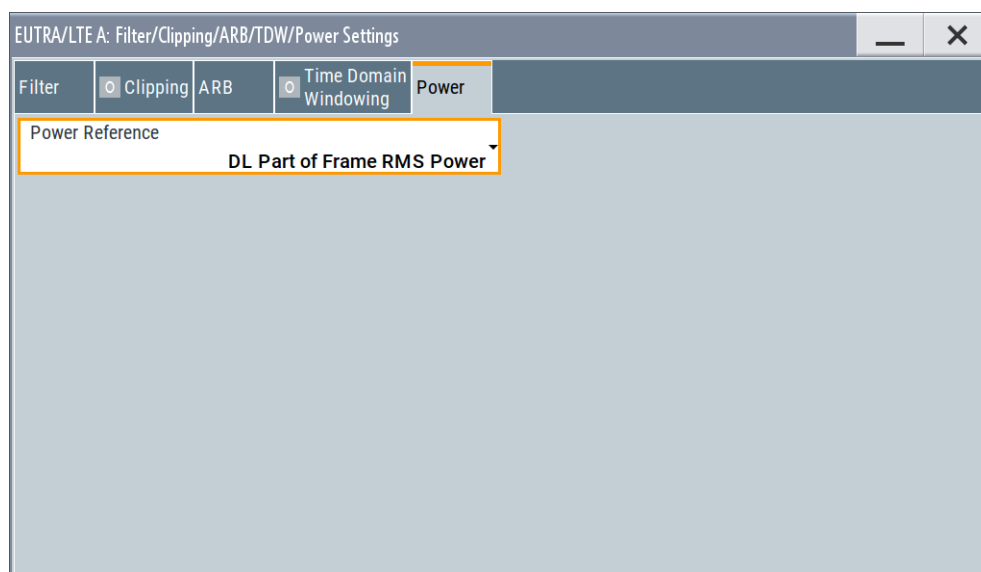

This dialog comprises the settings required for configuring the global power level of the generated LTE signal.

For an overview of the provided power settings and detailed information on how to adjust them, refer to [Chapter 9.3, "Adjusting the signal power"](#), on page 539.

Settings:

Power Reference	542
Reference UE	543
Reference Subframe/Slot	544
Reference Channel	544

Power Reference

Defines the reference the "Level" display in the status bar is referring to.

"Frame RMS Power"

The displayed RMS and PEP are measured during the whole frame.
All frames are considered, not only the first one.

"DL Part of Frame RMS Power"

The displayed RMS and PEP are measured during the DL part of the frame (all DL subframes and the DwPTS).
All frames are considered, not only the first one.

"UL Part of Frame RMS Power"

The displayed RMS and PEP are measured during the UL part of the frame (all UL subframes and the UpPTS).
All frames are considered, not only the first one.

"UE Burst RMS Power"

The displayed RMS and PEP are measured during an automatically selected **reference time span**, that is selected according to the following algorithm:

- For the first active UE, find the first active subframe.
In case of eMTC/NB-IoT, find the first transmission of the first active UE. Omit invalid subframes.
- Find the first PUSCH, PUCCH or both.
Exclude the DMRS.
- In PRACH mode, find the first PRACH preamble.
- If there is no active subframe, use the SRS.

The signal portion (subframe or slot number), the channel and the first active UE used as reference are displayed with the parameters [Reference Subframe/Slot](#), [Reference Channel](#), and [Reference UE](#). This power mode is required for the AWGN settings calculation (e.g. according to [TS 36.141](#)), in case the simulated UE does not use all subframes.

If at least one UL eMTC or NB-IoT UE is active, "UE Burst RMS Power" is the default level reference.

"NPBCH Symbols Power"

Option: R&S SMM-K115

Enabled in standalone NB-IoT operation (Downlink FDD mode, "Channel Bandwidth = 200 kHz" and "Activate NB-IoT = On")

The displayed RMS and PEP are measured during the NPBCH symbols 3, 9 and 11.

Remote command:

`[:SOURCE<hw>] :BB:EUTRa:POWC:LEVReference` on page 567

Reference UE

If [Power Reference](#) = "UL Burst RMS Power", indicates the **first active UE** used as reference of the RMS and PEP measurement.

If several UEs are active during the measurement time, the displayed RMS and PEP values apply **to all UEs** that are active during the reference measurement time.

Example:

Standard SISO configuration, standard signal routing, no additional baseband gain:

- Two active UEs with "UE1 > UE Power = 0 dB" and "UE2 > UE Power = 0 dB".
UE1 and UE2 have active allocations in subframe = 0
- "Power Reference = UL Burst RMS Power"
- Reference time indicated as "Reference UE = UE1" and "Reference Subframe = 0"
- RMS value "Status bar > Level = -30 dBm"

Because during the reference subframe both UEs are active, the power of each UE during this subframe is -33 dBm. The indication "Reference UE = UE1" is merely information on the reference time span.

Remote command:

`[:SOURCE<hw>] :BB:EUTRa:POWC:RUE?` on page 568

Reference Subframe/Slot

If **Power Reference** = "UL Burst RMS Power", displays the signal portion (subframe or slot) to that the measured RMS and PEP are referring.

Remote command:

[:SOURce<hw>] :BB:EUTRa:POWC:REFSubframe? on page 568

Reference Channel

If **Power Reference** = "UL Burst RMS Power", displays the channel type the measured RMS and PEP are referring to.

Remote command:

[:SOURce<hw>] :BB:EUTRa:POWC:REFChannel on page 567

9.4 Trigger settings

Access:

- ▶ Select "Baseband > EUTRA/LTE > Trigger In"

This dialog provides access to the settings necessary to select and configure the trigger, like trigger source, mode, trigger delay, trigger suppression, and to arm or trigger an internal trigger manually. The current signal generation status is displayed in the header of the tab together with information on the enabled trigger mode. As in the "Marker" and "Clock" tabs, this tab provides also access to the settings of the related connectors.



This section focuses on the available settings.

For information on how these settings affect the signal, refer to section "Basics on ..." in the R&S SMM100A user manual.

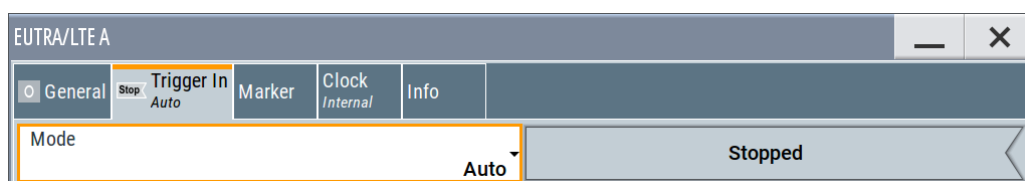



The provided trigger signals are not dedicated to a particular connector. Trigger signals can be mapped to one or more User x or T/M connectors.

Use the [Local and global connectors settings](#) to configure the signal mapping, the polarity, the trigger threshold and the input impedance of the input connectors.

To route and enable a trigger signal, proceed as follows:

- Define the signal source and the effect of a trigger event.
Select "Trigger In" > "Mode" and "Trigger In" > "Source".
- Define the connector where the selected signal is provided.
Use the "Global Connectors" settings.

Settings:

Trigger Settings Common to All Basebands.....	545
Trigger Mode.....	545
Signal Duration Unit.....	546
Trigger Signal Duration.....	546
Running/Stopped.....	546
Time Based Trigger.....	546
Trigger Time.....	547
Arm.....	547
Execute Trigger.....	547
Trigger Source.....	547
Sync. Output to External Trigger/Sync. Output to Trigger.....	547
External / Trigger Inhibit.....	548
(External) Delay Unit.....	549
(Specified) External Trigger Delay/(Specified) Trigger Delay.....	549
Actual Trigger Delay/Actual External Delay.....	549
Timing Configuration.....	549
L Signal Advance N_TA_offset.....	549

Trigger Settings Common to All Basebands

To enable simultaneous signal generation in all basebands, the R&S SMM100A couples the trigger settings in the available basebands in any instrument's configuration involving signal routing with signal addition. For example, in MIMO configuration, routing and summing of basebands or of streams.

The icon indicates that common trigger settings are applied.

You can access and configure the common trigger source and trigger mode settings in any of the basebands. An arm or a restart trigger event applies to all basebands, too. You can still apply different delay to each of the triggers individually.

Trigger Mode

Selects trigger mode, i.e. determines the effect of a trigger event on the signal generation.

- "Auto"
The signal is generated continuously.
- "Retrigger"

The signal is generated continuously. A trigger event (internal or external) causes a restart.

- "Armed Auto"
The signal is generated only when a trigger event occurs. Then the signal is generated continuously.
An "Arm" stops the signal generation. A subsequent trigger event (internal or external) causes a restart.
- "Armed Retrigger"
The signal is generated only when a trigger event occurs. Then the signal is generated continuously. Every subsequent trigger event causes a restart.
An "Arm" stops signal generation. A subsequent trigger event (internal or external) causes a restart.
- "Single"
The signal is generated only when a trigger event occurs. Then the signal is generated once to the length specified at "Signal Duration".
Every subsequent trigger event (internal or external) causes a restart.

Remote command:

[\[:SOURCE<hw>\]:BB:EUTRa\[:TRIGger\]:SEQUence](#) on page 570

Signal Duration Unit

Defines the unit for describing the length of the signal sequence to be output in the "Single" trigger mode.

Remote command:

[\[:SOURCE<hw>\]:BB:EUTRa:TRIGger:SLUNit](#) on page 572

Trigger Signal Duration

Requires trigger "Mode" > "Single".

Enters the length of the trigger signal sequence.

Use this parameter, for example, for the following applications:

- To output the trigger signal partly.
- To output a predefined sequence of the trigger signal.

Remote command:

[\[:SOURCE<hw>\]:BB:EUTRa:TRIGger:SLENgth](#) on page 572

Running/Stopped

With enabled modulation, displays the status of signal generation for all trigger modes.

- "Running"
The signal is generated; a trigger was (internally or externally) initiated in triggered mode.
- "Stopped"
The signal is not generated and the instrument waits for a trigger event.

Remote command:

[\[:SOURCE<hw>\]:BB:EUTRa:TRIGger:RMODE?](#) on page 572

Time Based Trigger

Requires trigger "Mode" > "Armed Auto"/"Single".

Activates time-based triggering with a fixed time reference.

The R&S SMM100A triggers signal generation when its operating system time ("Current Time") matches a specified time trigger ("Trigger Time"). As trigger source, you can use an internal trigger or an external global trigger.

How to: Chapter "Time-based triggering" in the R&S SMM100A user manual.

Remote command:

`[:SOURce<hw>] :BB:EUTRa:TRIGger:TIME [:STATe]` on page 574

Trigger Time

Requires trigger "Mode" > "Armed Auto"/"Single".

Sets date and time for a time-based trigger signal.

Set a trigger time that is later than the "Current Time". The current time is the operating system time of the R&S SMM100A. If you set an earlier trigger time than the current time, time-based triggering is not possible.

How to: Chapter "Time-based triggering" in the R&S SMM100A user manual.

"Date" Sets the date of the time-based trigger in format YYYY-MM-DD.

Remote command:

`[:SOURce<hw>] :BB:EUTRa:TRIGger:TIME:DATE` on page 573

"Time" Sets the time of the time-based trigger in format hh:mm:ss.

Remote command:

`[:SOURce<hw>] :BB:EUTRa:TRIGger:TIME:TIME` on page 573

Arm

Stops the signal generation until subsequent trigger event occurs.

Remote command:

`[:SOURce<hw>] :BB:EUTRa:TRIGger:ARM:EXECute` on page 571

Execute Trigger

For internal trigger source, executes trigger manually.

Remote command:

`[:SOURce<hw>] :BB:EUTRa:TRIGger:EXECute` on page 571

Trigger Source

The following sources of the trigger signal are available:

- "Internal"
The trigger event is executed manually by the "Execute Trigger".
- "External Global Trigger"
The trigger event is the active edge of an external trigger signal provided and configured at the User x connectors.
- "Baseband Sync In"
In primary-secondary instrument mode, secondary instruments are triggered by the active edge of the synchronization signal.

Remote command:

`[:SOURce<hw>] :BB:EUTRa:TRIGger:SOURce` on page 571

Sync. Output to External Trigger/Sync. Output to Trigger

Enables signal output synchronous to the trigger event.

- "On"
Corresponds to the default state of this parameter.
The signal calculation starts simultaneously with the trigger event. Because of the processing time of the instrument, the first samples are cut off and no signal is output. After elapsing of the internal processing time, the output signal is synchronous to the trigger event.

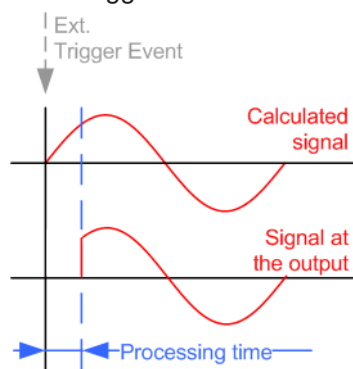

- "Off"
The signal output begins after elapsing of the processing time. Signal output starts with sample 0. The complete signal is output.
This mode is recommended for triggering of short signal sequences. Short sequences are sequences with signal duration comparable with the processing time of the instrument.

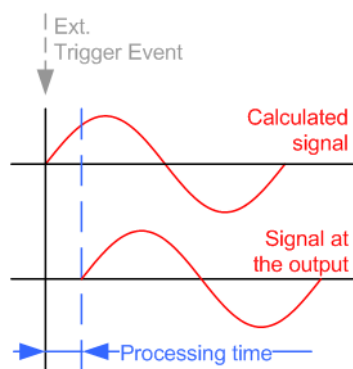

Remote command:

`[:SOURCE<hw>] :BB:EUTRa:TRIGger:EXTernal:SYNChronize:OUTPut`
on page 572

External / Trigger Inhibit

Applies for external trigger signal.

Sets the duration with that any following trigger event is suppressed. In "Retrigger" mode, for example, a new trigger event does not cause a restart of the signal generation until the specified inhibit duration does not expire.

For more information, see chapter "Basics" in the R&S SMM100A user manual.

Remote command:

`[:SOURCE<hw>] :BB:EUTRa:TRIGger [:EXTernal] :INHibit` on page 574

(External) Delay Unit

Determine whatever the trigger delay is expressed in samples or directly defined as a time period (seconds).

To specify the delay, use the parameter [\(Specified\) External Trigger Delay/\(Specified\) Trigger Delay](#).

The parameter [Actual Trigger Delay/Actual External Delay](#) displays the delay converted in time.

Remote command:

[\[:SOURCE<hw>\]:BB:EUTRa:TRIGger:DElay:UNIT](#) on page 571

(Specified) External Trigger Delay/(Specified) Trigger Delay

The name of the parameter and the units the delay is expressed in, changes depending on the parameter [\(External\) Delay Unit](#).

Delays the trigger event of the signal from:

- The external trigger source

Use this setting to:

- Synchronize the instrument with the device under test (DUT) or other external devices

For more information, see chapter "Basics on ..." in the R&S SMM100A user manual.

The parameter [Actual Trigger Delay/Actual External Delay](#) displays the delay converted in time.

Remote command:

[\[:SOURCE<hw>\]:BB:EUTRa:TRIGger\[:EXternal\]:DElay](#) on page 574

[\[:SOURCE<hw>\]:BB:EUTRa:TRIGger:EXternal:TDElay](#) on page 575

Actual Trigger Delay/Actual External Delay

Indicates the resulting external trigger delay in "Time" unit.

Remote command:

[\[:SOURCE<hw>\]:BB:EUTRa:TRIGger:EXternal:RDElay?](#) on page 575

Timing Configuration

Comprises settings related to the timing configuration.

Signal Advance N_TA_offset ← Timing Configuration

Sets the parameter N_{TA_offset} as defined in the [TS 36.211](#).

The parameter is available in "Uplink" direction and enabled "TDD" mode.

The [TS 36.211](#) defines the signal advance parameter depending on the duplexing mode and specifies the following values:

- For FDD mode: $N_{TA_offset} = 0$
- For TDD mode: $N_{TA_offset} = 624$.

In this implementation, however, the signal advance for the TDD mode can also be set to 0.

Remote command:

[\[:SOURCE<hw>\]:BB:EUTRa:TIMC:NTAoffset](#) on page 569

9.5 Marker settings

Access:

- ▶ Select "Baseband" > "EUTRA/LTE" > "Marker".

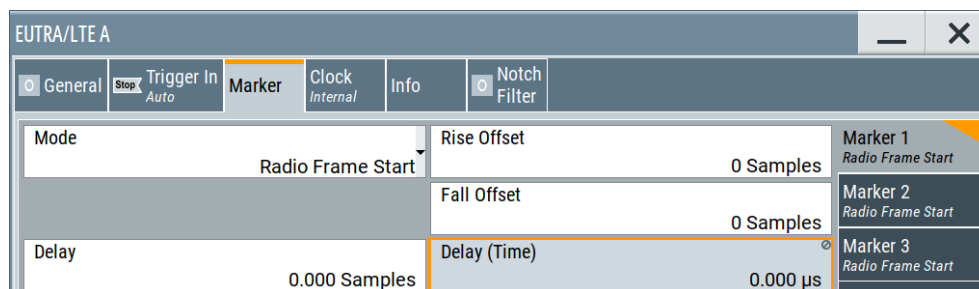

This tab provides settings to select and configure the marker output signal including marker mode and marker delay.

Routing and activating a marker signal

1. To define the signal shape of an individual marker signal "x", select "Marker" > "Marker x" > "Mode".
2. Optionally, define the connector for signal output. See [Chapter 9.7, "Local and global connectors settings"](#), on page 553.
You can map marker signals to one or more User x or T/M connectors.
3. Activate baseband signal generation. In the block diagram, set "Baseband" > "On".
The R&S SMM100A adds the marker signal to the baseband signal. Also, R&S SMM100A outputs this signal at the configured User x connector.

About marker output signals

This section focuses on the available settings.

For information on how these settings affect the signal, refer to section "Basics on ..." in the R&S SMM100A user manual.

Settings:

Marker Mode	550
Rise/Fall Offset	551
Marker x Delay	552
Delay (Time)	552

Marker Mode

Marker configuration for up to 3 markers. The settings are used to select the marker mode defining the shape and periodicity of the markers. The contents of the dialog change with the selected marker mode.

How to: ["Routing and activating a marker signal"](#) on page 550

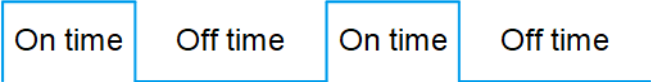
- "Restart (ARB)"
A marker signal is generated at the start of each ARB sequence.
- "Radio Frame Start"
A marker signal is generated at the start of each radio frame.
- "Frame Active Part"
The marker signal is high whenever a burst is active and low during inactive signal parts.
For example, during the gaps between bursts in uplink mode or the uplink subframe in downlink TDD mode.
Feed this marker signal into a pulse modulator to decrease the carrier leakage during inactive signal parts.
- "Subframe"
A marker signal is generated at the start of each subframe.
- "User Period"
A marker signal is generated at the beginning of every user-defined period, as set with the parameter "Period."
Remote command:
`[:SOURce<hw>] :BB:EUTRa:TRIGger:OUTPut<ch>:PERiod`
on page 577
- "ON/OFF Period"
A regular marker signal that is defined by an ON/OFF ratio. A period lasts one ON and OFF cycle.
- 
- Remote command:
`[:SOURce<hw>] :BB:EUTRa:TRIGger:OUTPut<ch>:OFFTime`
on page 577
`[:SOURce<hw>] :BB:EUTRa:TRIGger:OUTPut<ch>:ONTime`
on page 577
- "System Frame Number (SFN) Restart"
A marker signal is generated at the start of every SFN period.
Remote command:
`[:SOURce<hw>] :BB:EUTRa:TRIGger:OUTPut<ch>:MODE` on page 576

Rise/Fall Offset

(For marker modes Subframe, Radio Frame Start, and Restart (ARB))

Sets the value for the rise/fall offset.

The ramps of the marker signal are shifted by the specified number of a samples. Positive values delay the rising ramp; negative values - shift it back.

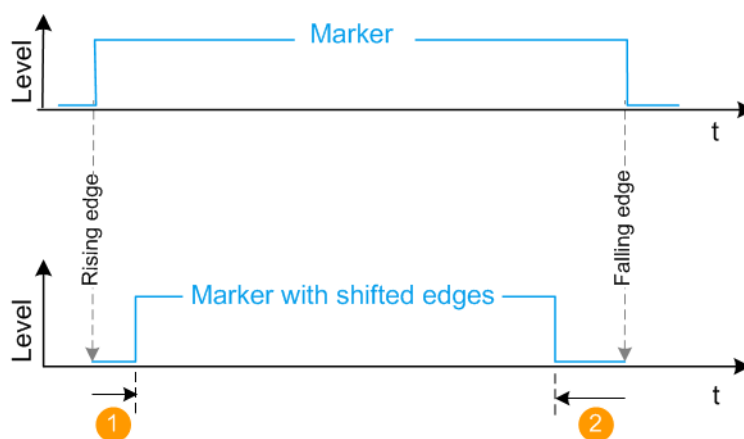

1 = Positive rise offset

2 = Positive fall offset

Remote command:

`[:SOURCE<hw>] :BB:EUTRa:TRIGger:OUTPut<ch>:ROFFset` on page 577

`[:SOURCE<hw>] :BB:EUTRa:TRIGger:OUTPut<ch>:FOFFset` on page 577

Marker x Delay

Delays the marker signal at the marker output relative to the signal generation start.

Variation of the parameter "Marker x" > "Delay" causes signal recalculation.

Remote command:

`[:SOURCE<hw>] :BB:EUTRa:TRIGger:OUTPut<ch>:DELay` on page 577

Delay (Time)

Shows the **marker delay** time in microseconds, milliseconds or seconds depending on the set marker delay.

Remote command:

`[:SOURCE<hw>] :BB:EUTRa:TRIGger:OUTPut<ch>:DINSec?` on page 578

9.6 Clock settings

Access:

- ▶ Select "Baseband > EUTRA/LTE > Clock"

This tab provides access to the settings necessary to select and configure the clock signal, like the clock source and clock mode.



This section focuses on the available settings.

For information on how the settings affect the signal, refer to chapter "Basics" in the R&S SMM100A user manual.

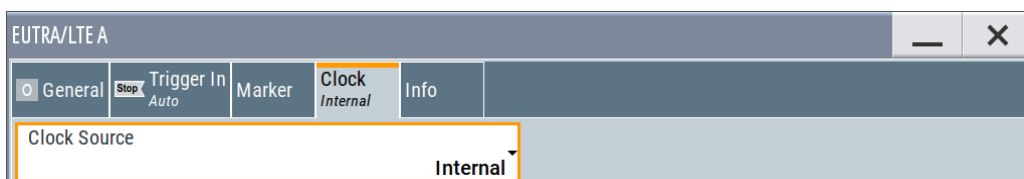

Defining the clock

The provided clock signals are not dedicated to a particular connector. They can be mapped to one or more User x and T/M/C connectors.

Use the [Local and global connectors settings](#) to configure the signal mapping, the polarity, the trigger threshold, and the input impedance of the input connectors.

To route and enable a trigger signal, perform the following *general steps*:

- Define the signal source, that is select the "Clock > Source".
- Define the connector where the selected signal is provided.
Use the [Local and global connectors settings](#).

Settings:

[Clock Source](#).....553

Clock Source

Selects the clock source.

- "Internal"
The instrument uses its internal clock reference.

Remote command:

[:SOURce<hw>] :BB:EUTRa:CLOCK:SOURCE on page 568

9.7 Local and global connectors settings

Accesses a dialog to configure local connectors or global connectors.

The button is available in the following dialogs or tabs:

- "Trigger / Marker / Clock" dialog that is accessible via the "TMC" block in the block diagram.
- "Trigger In", "Marker" and "Clock" tabs that are accessible via the "Baseband" block in the block diagram.



See also chapter "Local and global connectors settings" in the user manual.

10 Remote-control commands

The following commands are required to generate signals with the EUTRA/LTE options in a remote environment. We assume that the R&S SMM100A has already been set up for remote operation in a network as described in the R&S SMM100A documentation. A knowledge about the remote control operation and the SCPI command syntax are assumed.



Conventions used in SCPI command descriptions

For a description of the conventions used in the remote command descriptions, see section "Remote Control Commands" in the R&S SMM100A user manual.

Common Suffixes

The following common suffixes are used in remote commands:

Suffix	Value range	Description
ENTity<ch>	1	Optional keyword, provided for compatibility with R&S [®] SMW200A ENTity1:SOURce1 = SOURce1
SOURce<hw>	1	Available baseband signals
OUTPut<ch>	1 to 3	Available markers
SUBF<st0>	<ul style="list-style-type: none"> DL 0 to 39 UL 0 to 199 	Subframe number The maximum value depends on the selected sequence length, see [: SOURce<hw>] : BB : EUTRa : SLENgth.
ALLoc<ch0>	<ul style="list-style-type: none"> DL <ul style="list-style-type: none"> For subframes with PBCH, i.e. SUBF0, SUBF10, SUBF20 and SUBF30: <ch0> = 0 to 111 For all other subframes: <ch0> = 0 to 110 UL 0 to 7 Where 0 refers to UE1 for NB-IoT 0 to 100 	<ul style="list-style-type: none"> Allocation number Allocation number (user equipment number) NB-IoT DCI allocation
CELL<ch0> CELL<st0> CELL<dir> CELL<ccidx>	0 to 4	Component carrier Option R&S SMM-K85
CW<user> CW<cw> <cwidx>	1 2	Codeword
ITEM<ch0>	0 to 19	Number of rows in the DCI table

Suffix	Value range	Description
UE<st>	[1] to 8	User equipment (UL)
USER<ch>	1 2 3 4	DL user
PMCH<ch0>	0 to 15	PM channel number
<srsidx>	1 to 6	SRS set
BURSt<st0>	0 to 39	LAA bursts
CARRier<ch>	0 to 4	NB-IoT DL carrier
CELV<ch0>	0 to 3	CE level
CFG<ch0>	0 to 2	NPRACH configuration
TRANs<ch>	0 to 10	eMTC/NB-IoT allocation
ATT<ch0>	0 to 40 0 to 30	eMTC PRACH preamble attempt NPRACH preamble attempt

Programming examples

This description provides simple programming examples. The purpose of the examples is to present **all** commands for a given task. In real applications, one would rather reduce the examples to an appropriate subset of commands.

The programming examples have been tested with a software tool which provides an environment for the development and execution of remote tests. To keep the example as simple as possible, only the "clean" SCPI syntax elements are reported. Non-executable command lines (e.g. comments) start with two // characters.

At the beginning of the most remote control program, an instrument (p)reset is recommended to set the instrument to a definite state. The commands *RST and SYSTem:PRESet are equivalent for this purpose. *CLS also resets the status registers and clears the output buffer.

The following commands specific to the EUTRA/LTE standard are described here:

• Primary commands.....	556
• Filter/clipping/power.....	561
• Clock.....	568
• Timing configuration.....	569
• Trigger.....	569
• Marker.....	576
• General TDD commands.....	578
• General downlink commands.....	579
• General uplink commands.....	592
• DL frame configuration.....	604
• DL MBFSN.....	613
• DL carrier aggregation.....	625
• CSI-RS.....	630
• LAA and DRS.....	637
• Enhanced PBCH, PDSCH, PMCH.....	647
• Enhanced PCFICH, PHICH and PDCCH configuration.....	656

• Auto sequence.....	689
• UL frame configuration.....	701
• UL carrier aggregation.....	707
• UL enhanced.....	710
• User configuration.....	727
• EPDCCH.....	738
• Dummy data configuration.....	742
• SPS configuration.....	744
• User equipment.....	745
• Sidelink configuration.....	770
• eMTC/NB-IoT commands.....	799
• Test case wizard remote-control commands.....	932

10.1 Primary commands

<code>[:SOURce<hw>]:BB:EUTRa:STATe.....</code>	556
<code>[:SOURce<hw>]:BB:EUTRa:DUPLexing.....</code>	556
<code>[:SOURce<hw>]:BB:EUTRa:LINK.....</code>	557
<code>[:SOURce<hw>]:BB:EUTRa:STDMoDe.....</code>	557
<code>[:SOURce<hw>]:BB:EUTRa:PRESet.....</code>	557
<code>[:SOURce<hw>]:BB:EUTRa:SETTing:CATalog.....</code>	558
<code>[:SOURce<hw>]:BB:EUTRa:SETTing:DEL.....</code>	558
<code>[:SOURce<hw>]:BB:EUTRa:SETTing:LOAD.....</code>	558
<code>[:SOURce<hw>]:BB:EUTRa:SETTing:STORe.....</code>	559
<code>[:SOURce<hw>]:BB:EUTRa:SETTing:TMOD:TDD.....</code>	559
<code>[:SOURce<hw>]:BB:EUTRa:SETTing:TMOD:DL.....</code>	559
<code>[:SOURce<hw>]:BB:EUTRa:SLENgth.....</code>	559
<code>[:SOURce<hw>]:BB:EUTRa:SUSLen.....</code>	559
<code>[:SOURce<hw>]:BB:EUTRa:WAVeform:CREate.....</code>	560
<code>[:SOURce]:BB:EUTRa:VERSIon?.....</code>	560
<code>[:SOURce<hw>]:BB:EUTRa:UPLane:STATe.....</code>	560

`[:SOURce<hw>]:BB:EUTRa:STATe <State>`

Activates the standard and deactivates all the other digital standards and digital modulation modes in the same path.

Parameters:

<State> 1 | ON | 0 | OFF
 *RST: 0

Example: `SOURce1:BB:EUTRa:STATe ON`

Manual operation: See "State" on page 62

`[:SOURce<hw>]:BB:EUTRa:DUPLexing <Duplexing>`

Sets the duplexing mode.

Parameters:

<Duplexing> TDD | FDD
 *RST: FDD

Example: SOURce1:BB:EUTRa:DUPLexing FDD

Manual operation: See ["Duplexing"](#) on page 64

[:SOURce<hw>]:BB:EUTRa:LINK <Link>

Sets the transmission direction.

Parameters:

<Link> UP | DOWN
 *RST: DOWN

Example: SOURce:BB:EUTRa:LINK DOWN

Manual operation: See ["Link Direction"](#) on page 64

[:SOURce<hw>]:BB:EUTRa:STDMode <StandardMode>

Sets the supported 3GPP standard.

Parameters:

<StandardMode> LTE | IOT | LIOT

LTE

Standalone LTE mode.

IoT-specific commands containing the keywords `EMTC` or `NIOT` are discarded.

IOT

Standalone IoT mode.

The commands related to LTE-specific features like carrier aggregation or MBSFN are discarded.

LIOT

Mixed LTE and IoT configuration, for example for interoperability tests.

*RST: LTE

Example: See [Example "NPRACH configuration"](#) on page 812.

Options: LTE requires R&S SMM-K55
 IOT|LIOT require R&S SMM-K115

Manual operation: See ["Mode"](#) on page 64

[:SOURce<hw>]:BB:EUTRa:PRESet

Sets the parameters of the digital standard to their default values (*RST values specified for the commands).

Not affected is the state set with the command `SOURce<hw>:BB:EUTRa:STATe`.

Example: `SOURce1:BB:EUTRa:PRESet`

Manual operation: See ["Set to Default"](#) on page 62

[:SOURce<hw>]:BB:EUTRa:SETTING:CATalog <Catalog>

Queries the files with settings in the default directory. Listed are files with the file extension *.lte.

Parameters:

<Catalog> <filename1>,<filename2>,...

Returns a string of filenames separated by commas.

Example:

```
MMEM:CDIR /var/user/lte
SOURce1:BB:EUTRa:SETTING:CATalog?
// lte, test
SOURce1:BB:EUTRa:SETTING:DEL "test"
SOURce1:BB:EUTRa:SETTING:LOAD "lte"
// SOURce1:BB:EUTRa:SETTING:STORE "lte_2"
```

Manual operation: See ["Save/Recall"](#) on page 63

[:SOURce<hw>]:BB:EUTRa:SETTING:DEL <Filename>

Deletes the selected file from the default or the specified directory. Deleted are files with extension *.lte.

Setting parameters:

<Filename> string

Filename or complete file path; file extension can be omitted

Example:

See [\[:SOURce<hw>\]:BB:EUTRa:SETTING:CATalog](#) on page 558.

Usage:

Setting only

Manual operation: See ["Save/Recall"](#) on page 63

[:SOURce<hw>]:BB:EUTRa:SETTING:LOAD <Filename>

Loads the selected file from the default or the specified directory. Loaded are files with extension *.lte.

Parameters:

<Filename> string

Filename or complete file path; file extension can be omitted

Example:

See [\[:SOURce<hw>\]:BB:EUTRa:SETTING:CATalog](#) on page 558.

Manual operation: See ["Save/Recall"](#) on page 63

[:SOURce<hw>]:BB:EUTRa:SETTing:STORe <Filename>

Stores the current settings into the selected file; the file extension (*.lte) is assigned automatically.

Parameters:

<Filename> string
 Filename or complete file path

Example: See [:SOURce<hw>]:BB:EUTRa:SETTing:CATalog on page 558.

Manual operation: See "Save/Recall" on page 63

[:SOURce<hw>]:BB:EUTRa:SETTing:TMOD:TDD <Tdd>

[:SOURce<hw>]:BB:EUTRa:SETTing:TMOD:DL <Filename>

Selects a predefined test model as defined in TS 36.141.

Parameters:

<Filename> <test_model_name>

Example: SOURce1:BB:EUTRa:SETTing:TMOD:TDD 'E-TM1_1__20MHz'
 SOURce1:BB:EUTRa:SETTing:TMOD:DL 'ORAN-TC32371__FDD_1_4MHz'
 SOURce1:BB:EUTRa:SETTing:TMOD:DL 'N-TM_Standalone'

Options: NB-IoT test models (N-TM) require R&S SMM-K115
 O-RAN test models require R&S SMM-K175

Manual operation: See "Test Models" on page 65

[:SOURce<hw>]:BB:EUTRa:SLENgth <SLength>

Sets the sequence length of the signal in number of frames. The signal is calculated in advance and output in the arbitrary waveform generator. The maximum number of frames is calculated as follows:

Max. No. of Frames = Arbitrary waveform memory size/(sampling rate x 10 ms).

Parameters:

<SLength> integer
 Range: 1 to dynamic
 *RST: 1

Example: BB:EUTR:SLEN 4
 Selects the generation of 4 frames.

Manual operation: See "(Current) Sequence Length" on page 538

[:SOURce<hw>]:BB:EUTRa:SUSLen <subLen>

Sets the sequence length of the signal in number of subframes. The signal is calculated in advance and output in the arbitrary waveform generator.

Parameters:

<SubLen> integer
 Range: 1 to 1E5
 *RST: 1

Example:

BB:EUTR:SUSL 10
 Selects the generation of 10 subframes.

Manual operation: See "[\(Current\) Sequence Length](#)" on page 538

[:SOURCE<hw>]:BB:EUTRa:WAVEform:CREate <Filename>

Stores the current settings as an ARB signal in a waveform file (*.wv).

Setting parameters:

<Filename> string
 Filename or complete file path; file extension is assigned automatically

Example:

```
MMEM:CDIR /var/user/lte
SOURCE1:BB:EUTRa:STATE 1
SOURCE1:BB:EUTRa:WAVEform:CREate "lte_test"
```

Usage:

Setting only

Manual operation: See "[Generate Waveform](#)" on page 63

[:SOURCE]:BB:EUTRa:VERSion?

Queries the version of the 3GPP standard underlying the definitions.

Return values:

<Version> string

Example:

BB:EUTR:VERS?

Usage:

Query only

[:SOURCE<hw>]:BB:EUTRa:UPLane:STATe <UPlaneState>

Turns user plane data generation according to the O-RAN standard on and off.

Parameters:

<UPlaneState> 1 | ON | 0 | OFF
 *RST: 0

Example:

SOURCE1:BB:EUTRa:UPLane:STATe ON

Options:

R&S SMM-K175

Manual operation: See "[U-Plane Generation](#)" on page 68

10.2 Filter/clipping/power

10.2.1 Filter settings

<code>[:SOURce<hw>]:BB:EUTRa:FiLTer:TYPE</code>	561
<code>[:SOURce<hw>]:BB:EUTRa:FiLTer:MODE</code>	561
<code>[:SOURce<hw>]:BB:EUTRa:FiLTer:PARAmeter:APCO25</code>	562
<code>[:SOURce<hw>]:BB:EUTRa:FiLTer:PARAmeter:COSSine</code>	562
<code>[:SOURce<hw>]:BB:EUTRa:FiLTer:PARAmeter:GAUSSs</code>	562
<code>[:SOURce<hw>]:BB:EUTRa:FiLTer:PARAmeter:LPASs</code>	562
<code>[:SOURce<hw>]:BB:EUTRa:FiLTer:PARAmeter:LPASSEVM</code>	562
<code>[:SOURce<hw>]:BB:EUTRa:FiLTer:PARAmeter:PGAuss</code>	562
<code>[:SOURce<hw>]:BB:EUTRa:FiLTer:PARAmeter:RCOSSine</code>	562
<code>[:SOURce<hw>]:BB:EUTRa:FiLTer:PARAmeter:SPHase</code>	562
<code>[:SOURce<hw>]:BB:EUTRa:FiLTer:PARAmeter:COSSine:COFS</code>	562
<code>[:SOURce<hw>]:BB:EUTRa:FiLTer:PARAmeter:LTE:COFS</code>	562
<code>[:SOURce<hw>]:BB:EUTRa:FiLTer:PARAmeter:LTE:OPTimization</code>	563
<code>[:SOURce<hw>]:BB:EUTRa:FiLTer:PARAmeter:LTE:COFFactor</code>	563
<code>[:SOURce<hw>]:BB:EUTRa:FiLTer:PARAmeter:LTE:ROFFactor</code>	563
<code>[:SOURce<hw>]:BB:EUTRa:FiLTer:AUTO?</code>	563
<code>[:SOURce<hw>]:BB:EUTRa:FiLTer:PARAmeter:USER</code>	564
<code>[:SOURce<hw>]:BB:EUTRa:SRATe:VARiation</code>	564

`[:SOURce<hw>]:BB:EUTRa:FiLTer:TYPE <Type>`

Selects the baseband filter type.

Parameters:

<Type> RCOSine | COSSine | GAUSSs | LGAuss | CONE | COF705 |
 COEQualizer | COFEqualizer | C2K3x | RECTangle | PGAuss |
 LPASs | DIRac | ENPShape | EWPSHape | LTEFilter |
 LPASSEVM | SPHase | APCO25 | USER
 *RST: LTEFilter

Example: `SOURce1:BB:EUTRa:FiLTer:TYPE COS`
 Sets the filter type.

Manual operation: See "Filter" on page 532

`[:SOURce<hw>]:BB:EUTRa:FiLTer:MODE <OptMode>`

Selects an offline or real-time filter mode.

Parameters:

<OptMode> RTime | OFFLine
 *RST: RTime

Example: See `[:SOURce<hw>]:BB:EUTRa:FiLTer:PARAmeter:SPHase` on page 562

Manual operation: See "Filter Mode" on page 536

```
[[:SOURce<hw>]:BB:EUTRa:FILTer:PARAmeter:APCO25 <Apco25>
[:SOURce<hw>]:BB:EUTRa:FILTer:PARAmeter:COSSine <Cosine>
[:SOURce<hw>]:BB:EUTRa:FILTer:PARAmeter:GAUSSs <Gauss>
[:SOURce<hw>]:BB:EUTRa:FILTer:PARAmeter:LPASSs <LPass>
[:SOURce<hw>]:BB:EUTRa:FILTer:PARAmeter:LPASSEVM <CutoffFrequency>
[:SOURce<hw>]:BB:EUTRa:FILTer:PARAmeter:PGAUSSs <PGauss>
[:SOURce<hw>]:BB:EUTRa:FILTer:PARAmeter:RCOSSine <RCosine>
[:SOURce<hw>]:BB:EUTRa:FILTer:PARAmeter:SPHase <SPHase>
```

Sets the filter parameter.

Filter type	Parameter	Parameter name	Min	Max	Increment	Default
APCO25	Rolloff factor	<Apco25>	0.05	0.99	0.01	0.2
COSSine	Rolloff factor	<Cosine>	0	1	0.01	0.1
GAUSSs	BxT	<Gauss>	0.15	2.5	0.01	0.5
LPASSs	Cutoff frequency	<LPass>	0.02	2	0.01	0.34
LPASSEVM	Cutoff frequency	<CutoffFrequency>	0.05	2	0.01	0.29
PGAUSSs	BxT	<PGauss>	0.15	2.5	0.01	0.5
RCOSSine	Rolloff factor	<RCosine>	0	1	0.01	0.22
SPHase	BxT	<SPHase>	0.15	2.5	0.01	2

Example:

```
SOURce:BB:EUTRa:FILTer:TYPE COS
SOURce:BB:EUTRa:FILTer:PARAmeter:COSSine 0.1
SOURce:BB:EUTRa:FILTer:PARAmeter:COSSine:COFS -0.2
SOURce:BB:EUTRa:FILTer:MODE RTime
```

Manual operation: See "Rolloff factor or BxT" on page 534

```
[[:SOURce<hw>]:BB:EUTRa:FILTer:PARAmeter:COSSine:COFS <Cofs>
[:SOURce<hw>]:BB:EUTRa:FILTer:PARAmeter:LTE:COFS <CutOffFreqShift>
```

Sets the filter parameter.

Parameters:

```
<CutOffFreqShift> float
Range: -1 to 1
Increment: 0.01
*RST: -0.2
```

Example:

```
SOURce:BB:EUTRa:FILTer:TYPE LTEF
SOURce:BB:EUTRa:FILTer:PARAmeter:LTE:OPTimization ACP
SOURce:BB:EUTRa:FILTer:PARAmeter:LTE:COFS 0.34
```

Manual operation: See "Cutoff frequency shift" on page 535

[:SOURce<hw>]:BB:EUTRa:FILTer:PARAmeter:LTE:OPTimization <Optimization>

Defines the applied LTE filter.

Parameters:

<Optimization> EVM | ACP | ACPN | BENU
 Available are EVM, ACP, ACPN (ACP narrow) and BENU (Best EVM, no upsampling).
 *RST: EVM

Example: See [:SOURce<hw>]:BB:EUTRa:FILTer:PARAmeter:LTE:COFFactor on page 562

Manual operation: See "Optimization" on page 532

[:SOURce<hw>]:BB:EUTRa:FILTer:PARAmeter:LTE:COFFactor <CutoffFactor>

Sets the cutoff frequency factor for the LTE filter type.

Parameters:

<CutoffFactor> float
 Range: 0.02 to 2
 Increment: 0.001
 *RST: 0.34

Example:
 SOURce:BB:EUTRa:FILTer:TYPE LTEF
 SOURce:BB:EUTRa:FILTer:PARAmeter:LTE:OPTimization EVM
 SOURce:BB:EUTRa:FILTer:PARAmeter:LTE:COFFactor 0.1
 SOURce:BB:EUTRa:FILTer:PARAmeter:LTE:ROFFactor -0.2

Manual operation: See "Cutoff Frequency Factor" on page 536

[:SOURce<hw>]:BB:EUTRa:FILTer:PARAmeter:LTE:ROFFactor <RollOffFactor>

Sets the rolloff factor for the LTE filter type.

Parameters:

<RollOffFactor> float
 Range: 0 to 1
 Increment: 0.01
 *RST: 0.1

Example: See [:SOURce<hw>]:BB:EUTRa:FILTer:PARAmeter:LTE:COFFactor on page 563

Manual operation: See "Rolloff factor or BxT" on page 534

[:SOURce<hw>]:BB:EUTRa:FILTer:AUTO?

Queries if the internal ("Auto") filter is applied.

This filter is selected automatically, if carrier aggregation with carriers that span different bandwidths is used.

Return values:

<Auto> 1 | ON | 0 | OFF
*RST: 0

Example: SOURce1:BB:EUTRa:FILTer:AUTO?

Usage: Query only

Manual operation: See "[Optimization](#)" on page 532

[:SOURce<hw>]:BB:EUTRa:FILTer:PARAmeter:USER <Filename>

Loads the file from the default or the specified directory.

Loaded are files with extension VAF or DAT.

Parameters:

<Filename> string
Complete file path incl. filename and extension

Example: SOURce:BB:EUTRa:FILTer:TYPE USER
SOURce:BB:EUTRa:FILTer:PARAmeter:USER "/var/user/my_filter.dat"

Manual operation: See "[Load User Filter](#)" on page 533

[:SOURce<hw>]:BB:EUTRa:SRATe:VARiation <Variation>

Sets the output sample rate.

A variation of this parameter affects the ARB clock rate; all other signal parameters remain unchanged.

The current value of this parameter depends on the current physical settings, like the channel bandwidth.

Parameters:

<Variation> float
Range: 400 to 4E7
Increment: 0.001
*RST: 15.360000E6
Default unit: Hz

Example: SOURce:BB:EUTRa:LINK DOWN
SOURce:BB:EUTRa:DL:BW BW10_00
SOURce:BB:EUTRa:SRATe:VARiation?
// 15360000

Manual operation: See "[Sample Rate Variation](#)" on page 536

10.2.2 Clipping settings

<code>[:SOURce<hw>]:BB:EUTRa:CLIPping:LEVel</code>	565
<code>[:SOURce<hw>]:BB:EUTRa:CLIPping:MODE</code>	565
<code>[:SOURce<hw>]:BB:EUTRa:CLIPping:STATe</code>	565

`[:SOURce<hw>]:BB:EUTRa:CLIPping:LEVel <Level>`

Sets the limit for level clipping.

Parameters:

<code><Level></code>	integer
	Range: 1 to 100
	*RST: 100

Example:

```
BB:EUTR:CLIP:LEV 80PCT
```

Sets the limit for level clipping to 80% of the maximum level.

```
BB:EUTR:CLIP:STAT ON
```

Activates level clipping.

Manual operation: See "[Clipping Level](#)" on page 537

`[:SOURce<hw>]:BB:EUTRa:CLIPping:MODE <Mode>`

Sets the method for level clipping.

Parameters:

<code><Mode></code>	VECTor SCALar
	VECTor
	The reference level is the amplitude $ i+jq $.
	SCALar
	The reference level is the absolute maximum of the I and Q values.
	*RST: VECTor

Example:

```
BB:EUTR:CLIP:MODE SCAL
```

Selects the absolute maximum of all the I and Q values as the reference level.

```
BB:EUTR:CLIP:LEV 80PCT
```

Sets the limit for level clipping to 80% of this maximum level.

```
BB:EUTR:CLIP:STAT ON
```

Activates level clipping.

Manual operation: See "[Clipping Mode](#)" on page 538

`[:SOURce<hw>]:BB:EUTRa:CLIPping:STATe <State>`

Activates level clipping (Clipping). The value is defined with the command

`[SOURce:]BB:EUTRa:CLIPping:LEVel`, the mode of calculation with the command `[SOURce:]BB:EUTRa:CLIPping:MODE`.

Parameters:

<State> ON | OFF
 *RST: 0

Example:

BB:EUTR:CLIP:STAT ON
 Activates level clipping.

Manual operation: See "[Clipping State](#)" on page 537

10.2.3 Time domain windowing settings

[:SOURce<hw>]:BB:EUTRa:TDW:STATe <State>

Activates/deactivates the time domain windowing.

Parameters:

<State> 1 | ON | 0 | OFF
 *RST: OFF

Example:

BB:EUTR:TDW:STAT ON
 Activates time domain windowing.

Manual operation: See "[State](#)" on page 530

[:SOURce<hw>]:BB:EUTRa:TDW:TRTime <TransitionTime>

Sets the transition time when time domain windowing is active.

Parameters:

<TransitionTime> float
 Range: 0 to 1E-5
 Increment: 1E-7
 *RST: 5E-6
 Default unit: s

Example:

SOURce1:BB:EUTRa:TDW:TRTime 0.000002
 Sets the transition time to 2us.

Manual operation: See "[Transition Time](#)" on page 531

10.2.4 Power settings

[:SOURce<hw>]:BB:EUTRa:POWC:LEVReference	567
[:SOURce<hw>]:BB:EUTRa:POWC:REFChannel	567
[:SOURce<hw>]:BB:EUTRa:POWC:REFSubframe?	568
[:SOURce<hw>]:BB:EUTRa:POWC:RUE?	568

[:SOURce<hw>]:BB:EUTRa:POWC:LEVReference <LevelReference>

Defines the reference for the "Level" display in the status bar.

Parameters:

<LevelReference> FRMS | DRMS | UEBurst | URMS | NPBCH

FRMS

The displayed RMS and PEP are measured during the whole frame.

All frames are considered, not only the first one.

DRMS

The displayed RMS and PEP are measured during the DL part of the frame (all DL subframes and the DwPTS).

All frames are considered, not only the first one.

URMS

The displayed RMS and PEP are measured during the UL part of the frame (all UL subframes and the UpPTS).

All frames are considered, not only the first one.

UEBurst

The displayed RMS and PEP are measured during a single sub-frame (or slot) of a certain UE.

NPBCH

In NB-IoT standalone operation, the displayed RMS and PEP are measured during the NPBCH symbols 3, 9 and 11.

*RST: FRMS

Example:

SOURce1:BB:EUTRa:POWC:LEVReference UEBurst
Sets level reference to UE burst RMS power

Options:

NPBCH requires R&S SMM-K115

Manual operation:

See "[Power Reference](#)" on page 542

[:SOURce<hw>]:BB:EUTRa:POWC:REFChannel <RefChannel>

If [:SOURce<hw>]:BB:EUTRa:POWC:LEVReferenceUEBurst, queries the channel type to that the measured RMS and PEP are referring.

Parameters:

<RefChannel> NF | PUSCH | PUCCH | PRACH | SRS | PUCPUS | SL

*RST: NF

Example:

BB:EUTRa:POWC:LEVR UEB
BB:EUTRa:POWC:RUE?

Options:

SL requires R&S SMM-K119

Manual operation:

See "[Reference Channel](#)" on page 544

[:SOURCE<hw>]:BB:EUTRa:POWC:REFSubframe?

If [:SOURCE<hw>] :BB:EUTRa:POWC:LEVReferenceUEBurst, queries the sub-frame or slot number used as reference for measuring the RMS and PEP values.

Return values:

<RefSubframe> integer
 Range: 0 to 39
 *RST: 0

Example:

SOURCE1:BB:EUTRa:POWC:LEVReference UEB
 SOURCE1:BB:EUTRa:POWC:REFSubframe?

Usage: Query only

Manual operation: See "Reference Subframe/Slot" on page 544

[:SOURCE<hw>]:BB:EUTRa:POWC:RUE?

If [:SOURCE<hw>] :BB:EUTRa:POWC:LEVReferenceUEBurst, queries the UE to that the measured RMS and PEP are referring.

Return values:

<ReferenceUe> UE1 | UE2 | UE3 | UE4
 *RST: UE1

Example:

BB:EUTRa:POWC:LEVReference UEB
 BB:EUTRa:POWC:RUE?
 Queries the reference UE

Usage: Query only

Manual operation: See "Reference UE" on page 543

10.3 Clock

[:SOURCE<hw>]:BB:EUTRa:CLOCK:SOURCE.....	568
[:SOURCE<hw>]:BB:EUTRa:CLOCK:MODE.....	569

[:SOURCE<hw>]:BB:EUTRa:CLOCK:SOURCE <Source>

Selects the clock source:

- INTernal: Internal clock reference
- ELClock: External local clock
- EXTernal = ELClock: Setting only
 Provided for backward compatibility with other Rohde & Schwarz signal generators

Parameters:

<Source> INTernal
 *RST: INTernal

Example: `SOURce1:BB:EUTRa:CLOCK:SOURce INTernal`
 Selects an internal clock reference.

Manual operation: See ["Clock Source"](#) on page 553

[:SOURce<hw>]:BB:EUTRa:CLOCK:MODE <Mode>

Sets the type of externally supplied clock.

Parameters:

<Mode> SAMPLE
 *RST: SAMPLE

Example: `SOURce1:BB:EUTRa:CLOCK:MODE SAMPLE`

10.4 Timing configuration

[:SOURce<hw>]:BB:EUTRa:TIMC:NTAoffset <NtaOffset>

Sets the parameter $N_{TA\ offset}$ as defined in the 3GPP TS 36.211.

Parameters:

<NtaOffset> NTA0 | NTA624
 *RST: NTA0

Example: `BB:EUTRa:TIMC:NTA NTA0`
 Sets parameter $N_{TA\ offset}$

Manual operation: See ["Signal Advance N_TA_offset"](#) on page 549

10.5 Trigger

Example: Configure and enable triggering

```
SOURce1:BB:EUTRa:TRIGger:SEQuence SINGLE
SOURce1:BB:EUTRa:TRIGger:SLENgth 200
// the first 200 samples of the current waveform will be output after
// the next trigger event

SOURce1:BB:EUTRa:TRIGger:SOURce INT
SOURce1:BB:EUTRa:TRIGger:SEQuence ARETrigger
SOURce1:BB:EUTRa:STAT ON
SOURce1:BB:EUTRa:TRIGger:EXEcute
// executes a trigger, signal generation starts
SOURce1:BB:EUTRa:TRIGger:ARM:EXEcute
// signal generation stops
SOURce1:BB:EUTRa:TRIGger:EXEcute
// executes a trigger, signal generation starts again
```

Example: Specifying delay and inhibit values in time units

```

SOURCEl:BB:EUTRa:CLOCK 1000000
SOURCEl:BB:EUTRa:TRIGger:SEQuence ARET
SOURCEl:BB:EUTRa:TRIGger:SOURce EGT1
// external trigger signal must be provided at the USER connector
// SOURCEl:BB:EUTRa:TRIGger:EXTErnal:SYNChronize:OUTPut 1
SOURCEl:BB:EUTRa:TRIGger:DELay:UNIT SAMP
SOURCEl:BB:EUTRa:TRIGger:EXTErnal:DELay 100
SOURCEl:BB:EUTRa:TRIGger:EXTErnal:RDELay?
// Response: 100

SOURCEl:BB:EUTRa:TRIGger:DELay:UNIT TIME
SOURCEl:BB:EUTRa:TRIGger:EXTErnal:TDELay 0.00001
SOURCEl:BB:EUTRa:TRIGger:EXTErnal:RDELay?
// Response: 0.00001

SOURCEl:BB:EUTRa:TRIGger:DELay:UNIT SAMP
SOURCEl:BB:EUTRa:TRIGger:EXTErnal:DELay 10

```

[SOURCE<hw>]:BB:EUTRa:TRIGger:SEQuence.....	570
[SOURCE<hw>]:BB:EUTRa:TRIGger:SOURce.....	571
[SOURCE<hw>]:BB:EUTRa:TRIGger:ARM:EXECute.....	571
[SOURCE<hw>]:BB:EUTRa:TRIGger:DELay:UNIT.....	571
[SOURCE<hw>]:BB:EUTRa:TRIGger:EXECute.....	571
[SOURCE<hw>]:BB:EUTRa:TRIGger:EXTErnal:SYNChronize:OUTPut.....	572
[SOURCE<hw>]:BB:EUTRa:TRIGger:RMODE?.....	572
[SOURCE<hw>]:BB:EUTRa:TRIGger:SLUNit.....	572
[SOURCE<hw>]:BB:EUTRa:TRIGger:SLENGth.....	572
[SOURCE<hw>]:BB:EUTRa:TRIGger:TIME:DATE.....	573
[SOURCE<hw>]:BB:EUTRa:TRIGger:TIME:TIME.....	573
[SOURCE<hw>]:BB:EUTRa:TRIGger:TIME[:STATE].....	574
[SOURCE<hw>]:BB:EUTRa:TRIGger[:EXTErnal]:DELay.....	574
[SOURCE<hw>]:BB:EUTRa:TRIGger[:EXTErnal]:INHibit.....	574
[SOURCE<hw>]:BB:EUTRa:TRIGger:EXTErnal:RDELay?.....	575
[SOURCE<hw>]:BB:EUTRa:TRIGger:EXTErnal:TDELay.....	575

[SOURCE<hw>]:BB:EUTRa:TRIGger:SEQuence <TriggerMode>

Selects the trigger mode:

- AUTO = auto
- RETRigger = retrigger
- AAUTo = armed auto
- ARETRigger = armed retrigger
- SINGle = single

Parameters:

```

<TriggerMode>    AUTO | RETRigger | AAUTo | ARETRigger | SINGle
*RST:            AUTO

```

Manual operation: See ["Trigger Mode"](#) on page 545

[[:SOURce<hw>]:BB:EUTRa:TRIGger:SOURce <Source>

Selects the trigger signal source and determines the way the triggering is executed. Provided are:

- Internal triggering by a command (INTernal)
- External trigger signal via one of the local or global connectors
 - EGT1 | EGT2: External global trigger
 - EGC1 | EGC2: External global clock
- In primary-secondary instrument mode, the external baseband synchronization signal (BBSY)
- OBASeband | BEXTernal | EXTernal: Setting only
 Provided only for backward compatibility with other Rohde & Schwarz signal generators.
 The R&S SMM100A accepts these values and maps them automatically as follows:
 EXTernal = EGT1, BEXTernal = EGT2, OBASeband = INTA

Parameters:

<Source> INTernal|EGT1|EGT2|EGC1|EGC2|EXTernal|BBSY
 *RST: INTernal

Example: See [Example"Configure and enable triggering"](#) on page 569.

Manual operation: See ["Trigger Source"](#) on page 547

[[:SOURce<hw>]:BB:EUTRa:TRIGger:ARM:EXECute

Stops signal generation; a subsequent trigger event restarts signal generation.

Usage: Event

Manual operation: See ["Arm"](#) on page 547

[[:SOURce<hw>]:BB:EUTRa:TRIGger:DELay:UNIT <DelUnit>

Sets the units in that the trigger delay is expressed.

Parameters:

<DelUnit> SAMPlE | TIME
 *RST: SAMPlE

Manual operation: See ["\(External\) Delay Unit"](#) on page 549

[[:SOURce<hw>]:BB:EUTRa:TRIGger:EXECute

Executes a trigger.

Usage: Event

Manual operation: See ["Execute Trigger"](#) on page 547

[:SOURce<hw>]:BB:EUTRa:TRIGger:EXTErnal:SYNChronize:OUTPut
 <OutputState>

Enables signal output synchronous to the trigger event.

Parameters:

<OutputState> 1 | ON | 0 | OFF

*RST: 1

Manual operation: See ["Sync. Output to External Trigger/Sync. Output to Trigger"](#) on page 547

[:SOURce<hw>]:BB:EUTRa:TRIGger:RMODE?

Queries the signal generation status.

Return values:

<RunMode> STOP | RUN

Example: SOURce1:BB:EUTRa:TRIGger:RMODE?

Usage: Query only

Manual operation: See ["Running/Stopped"](#) on page 546

[:SOURce<hw>]:BB:EUTRa:TRIGger:SLUNit <SeqLenUnit>

Defines the unit for the entry of the signal sequence length.

Parameters:

<SeqLenUnit> SEQUENCE | FRAME | SUBFrame | SLOT | SAMPLE

FRAME

A single frame is generated after a trigger event.

SEQUENCE

A single sequence is generated after a trigger event.

SUBFrame

A single subframe is generated after a trigger event.

SLOT

A single slot is generated after a trigger event.

SAMPLE

Number of samples are generated after a trigger event.

*RST: SEQUENCE

Manual operation: See ["Signal Duration Unit"](#) on page 546

[:SOURce<hw>]:BB:EUTRa:TRIGger:SLENGth <SequenceLength>

Defines the length of the signal sequence that is output in the SINGLE trigger mode.

Parameters:

<SequenceLength> integer
 Range: 1 to 4294967295
 *RST: 1

Manual operation: See "[Trigger Signal Duration](#)" on page 546

[:SOURce<hw>]:BB:EUTRa:TRIGger:TIME:DATE <Year>, <Month>, <Day>

Sets the date for a time-based trigger signal. For trigger modes single or armed auto, you can activate triggering at this date via the following command:

SOURce<hw>:BB:<DigStd>:TRIGger:TIME:STATe

<DigStd> is the mnemonic for the digital standard, for example, ARB. Time-based triggering behaves analogously for all digital standards that support this feature.

Parameters:

<Year> integer
 Range: 1980 to 9999

<Month> integer
 Range: 1 to 12

<Day> integer
 Range: 1 to 31

Example: See example "Configure a time-based trigger signal" in the sub-chapter "Trigger Commands" of the chapter "SOURce:BB:ARB subsystem" in the R&S SMM100A user manual.

Manual operation: See "[Trigger Time](#)" on page 547

[:SOURce<hw>]:BB:EUTRa:TRIGger:TIME:TIME <Hour>, <Minute>, <Second>

Sets the time for a time-based trigger signal. For trigger modes single or armed auto, you can activate triggering at this time via the following command:

SOURce<hw>:BB:<DigStd>:TRIGger:TIME:STATe

<DigStd> is the mnemonic for the digital standard, for example, ARB. Time-based triggering behaves analogously for all digital standards that support this feature.

Parameters:

<Hour> integer
 Range: 0 to 23

<Minute> integer
 Range: 0 to 59

<Second> integer
 Range: 0 to 59

Example: See example "Configure a time-based trigger signal" in the sub-chapter "Trigger Commands" of the chapter "SOURCE:BB:ARB subsystem" in the R&S SMM100A user manual.

Manual operation: See ["Trigger Time"](#) on page 547

[:SOURCE<hw>] : BB : EUTRa : TRIGger : TIME [: STATE] <State>

Activates time-based triggering with a fixed time reference. If activated, the R&S SMM100A triggers signal generation when its operating system time matches a specified time.

Specify the trigger date and trigger time with the following commands:

```
SOURCE<hw>:BB:<DigStd>:TRIGger:TIME:DATE
```

```
SOURCE<hw>:BB:<DigStd>:TRIGger:TIME:TIME
```

<DigStd> is the mnemonic for the digital standard, for example, ARB. Time-based triggering behaves analogously for all digital standards that support this feature.

Parameters:

<State> 1 | ON | 0 | OFF
*RST: 0

Example: See example "Configure a time-based trigger signal" in the sub-chapter "Trigger Commands" of the chapter "SOURCE:BB:ARB subsystem" in the R&S SMM100A user manual.

Manual operation: See ["Time Based Trigger"](#) on page 546

[:SOURCE<hw>] : BB : EUTRa : TRIGger [: EXTERNAL] : DELay <Delay>

Sets the trigger delay.

Parameters:

<Delay> float
Range: 0 to 1099511627774
Increment: 0.01
*RST: 0
Default unit: Samples

Example: See [Example "Specifying delay and inhibit values in time units"](#) on page 570.

Manual operation: See ["\(Specified\) External Trigger Delay/\(Specified\) Trigger Delay"](#) on page 549

[:SOURCE<hw>] : BB : EUTRa : TRIGger [: EXTERNAL] : INHibit <Inhibit>

Specifies the number of symbols by which a restart is inhibited.

Parameters:

<Inhibit> integer
 Range: 0 to dynamic
 *RST: 0

Example: See [Example"Specifying delay and inhibit values in time units"](#) on page 570.

Manual operation: See ["External / Trigger Inhibit"](#) on page 548

[:SOURce<hw>]:BB:EUTRa:TRIGger:EXTErnal:RDELay?

Queries the time (in seconds) of an external trigger event is delayed for.

Return values:

<ExtResultDelay> float
 Range: 0 to 688
 Increment: 250E-12
 *RST: 0

Example: See [Example"Specifying delay and inhibit values in time units"](#) on page 570.

Usage: Query only

Manual operation: See ["Actual Trigger Delay/Actual External Delay"](#) on page 549

[:SOURce<hw>]:BB:EUTRa:TRIGger:EXTErnal:TDELay <Delay>

Specifies the trigger delay for external triggering. The value affects all external trigger signals.

Parameters:

<Delay> float
 Range: 0 to 688
 Increment: 250E-12
 *RST: 0
 Default unit: s

Example: See [Example"Specifying delay and inhibit values in time units"](#) on page 570.

Manual operation: See ["\(Specified\) External Trigger Delay/\(Specified\) Trigger Delay"](#) on page 549

10.6 Marker

Example: Configure and enable standard marker signals

```

SOURcel:BB:EUTRa:TRIGger:OUTPut1:MODE FRAM
// selects a frame marker
SOURcel:BB:EUTRa:TRIGger:OUTPut1:ROFFset 20
// sets a rise offset of 20 samples
SOURcel:BB:EUTRa:TRIGger:OUTPut1:FOFFset 200
// sets a fall offset of 200 samples

SOURcel:BB:EUTRa:TRIGger:OUTPut2:MODE RAT
SOURcel:BB:EUTRa:TRIGger:OUTPut2:ONTime 20
SOURcel:BB:EUTRa:TRIGger:OUTPut2:OFFTime 200

SOURcel:BB:EUTRa:TRIGger:OUTPut3:MODE PERiod
SOURcel:BB:EUTRa:TRIGger:OUTPut3:PERiod 1600
// sets a period of 1600 samples
// the marker signal is repeated every 1600th sample

SOURcel:BB:EUTRa:TRIGger:OUTPut3:DElay 1000
// Sets a delay of 1000 samples.
SOURcel:BB:EUTRa:TRIGger:OUTPut3:DINsec?
// Response in microseconds: 65.1041666666667
// Corresponds to a delay of about 65.104 microseconds.

```

<code>[:SOURce<hw>]:BB:EUTRa:TRIGger:OUTPut<ch>:MODE</code>	576
<code>[:SOURce<hw>]:BB:EUTRa:TRIGger:OUTPut<ch>:FOFFset</code>	577
<code>[:SOURce<hw>]:BB:EUTRa:TRIGger:OUTPut<ch>:ROFFset</code>	577
<code>[:SOURce<hw>]:BB:EUTRa:TRIGger:OUTPut<ch>:ONTime</code>	577
<code>[:SOURce<hw>]:BB:EUTRa:TRIGger:OUTPut<ch>:OFFTime</code>	577
<code>[:SOURce<hw>]:BB:EUTRa:TRIGger:OUTPut<ch>:PERiod</code>	577
<code>[:SOURce<hw>]:BB:EUTRa:TRIGger:OUTPut<ch>:DElay</code>	577
<code>[:SOURce<hw>]:BB:EUTRa:TRIGger:OUTPut<ch>:DINSec?</code>	578

`[:SOURce<hw>]:BB:EUTRa:TRIGger:OUTPut<ch>:MODE <Mode>`

Defines the signal for the selected marker output.

Parameters:

`<Mode>` SUBFram | FRAM | REStart | PERiod | RATio | FAP | SFNRestart
 *RST: FRAM

Example: See [Example "Configure and enable standard marker signals"](#) on page 576.

Manual operation: See ["Marker Mode"](#) on page 550

```
[ :SOURce<hw>]:BB:EUTRa:TRIGger:OUTPut<ch>:FOFFset <FallOffset>
[:SOURce<hw>]:BB:EUTRa:TRIGger:OUTPut<ch>:ROFFset <RiseOffset>
```

Sets the rise offset for on/off ratio marker in number of samples.

Parameters:

```
<RiseOffset>      integer
                  Range:    -640000 to 640000
                  *RST:     0
```

Example: See [Example"Configure and enable standard marker signals"](#) on page 576.

Manual operation: See ["Rise/Fall Offset"](#) on page 551

```
[ :SOURce<hw>]:BB:EUTRa:TRIGger:OUTPut<ch>:ONTime <OnTime>
[:SOURce<hw>]:BB:EUTRa:TRIGger:OUTPut<ch>:OFFTime <OffTime>
```

Sets the number of samples during which the marker output is on or off.

Parameters:

```
<OffTime>         integer
                  Range:    1 to 16777215
                  *RST:     1
```

Example: See [Example"Configure and enable standard marker signals"](#) on page 576.

Manual operation: See ["Marker Mode"](#) on page 550

```
[ :SOURce<hw>]:BB:EUTRa:TRIGger:OUTPut<ch>:PERiod <Period>
```

Sets the repetition rate for the signal at the marker outputs.

Parameters:

```
<Period>          unsigned integer
                  Range:    1 to 4294967295
                  Increment: 1
                  *RST:     2
                  Default unit: Samples
```

Example: See [Example"Configure and enable standard marker signals"](#) on page 576.

Manual operation: See ["Marker Mode"](#) on page 550

```
[ :SOURce<hw>]:BB:EUTRa:TRIGger:OUTPut<ch>:DELay <Delay>
```

Defines the delay between the signal on the marker outputs and the start of the signals.

Parameters:

<Delay> float
 Range: 0 to 16777215
 Increment: 1E-3
 *RST: 0

Example: See [Example "Configure and enable standard marker signals"](#) on page 576.

Manual operation: See ["Marker x Delay"](#) on page 552

[:SOURce<hw>]:BB:EUTRa:TRIGger:OUTPut<ch>:DINSec?

Queries the marker delay in microseconds.

You can define a marker delay in samples via `[:SOURce<hw>]:BB:EUTRa:TRIGger:OUTPut<ch>:DELay`.

Return values:

<DelayInS> float
 Range: 0 to 16777215
 Increment: 1E-3
 *RST: 0

Example: See [Example "Configure and enable standard marker signals"](#) on page 576.

Usage: Query only

Manual operation: See ["Delay \(Time\)"](#) on page 552

10.7 General TDD commands

[:SOURce<hw>]:BB:EUTRa:TDD:SPSConf	578
[:SOURce<hw>]:BB:EUTRa:TDD:UDConf	579
[:SOURce<hw>]:BB:EUTRa:TDD:UPTS	579

[:SOURce<hw>]:BB:EUTRa:TDD:SPSConf <SpecSubfrConf>

In TDD mode, sets the special subframe configuration number.

Parameters:

<SpecSubfrConf> integer
 Range: 0 to 9
 *RST: 0

Example: `SOURce1:BB:EUTRa:TDD:SPSConf 2`

Options: R&S SMM-K112: Special subframe configuration 9
 R&S SMM-K119: Special subframe configuration 10 (if "Mode = LTE")

R&S SMM-K143: Special subframe configuration 10 (if "Mode = eMTC/NB-LoT")

Manual operation: See ["TDD Special Subframe Config"](#) on page 100

[:SOURce<hw>]:BB:EUTRa:TDD:UDConf <ULDLConf>

In TDD mode, sets the uplink/downlink configuration number.

Parameters:

<ULDLConf> integer
 Range: 0 to 6
 *RST: 0

Example: :SOURce1:BB:EUTRa:TDD:UDConf 2
 Sets the UL/DL configuration

Manual operation: See ["TDD UL/DL Configuration"](#) on page 100

[:SOURce<hw>]:BB:EUTRa:TDD:UPTS <UpPtsSymbol>

If [:SOURce<hw>] :BB:EUTRa:TDD:SPSConf 10, sets the number of UpTPS symbols.

Parameters:

<UpPtsSymbol> 1 | 2
 *RST: 1

Example: SOURce1:BB:EUTRa:DUPLexing TDD
 SOURce:BB:EUTRa:TDD:SPSConf 10
 SOURce:BB:EUTRa:TDD:UPTS 2

Options: R&S SMM-K119 (if "Mode = LTE")
 R&S SMM-K143 (if "Mode = eMTC/NB-LoT")

Manual operation: See ["Number of UpPTS Symbols"](#) on page 100

10.8 General downlink commands

[:SOURce<hw>]:BB:EUTRa:DL:CONF:MODE.....	580
[:SOURce<hw>]:BB:EUTRa:DL:MIMO:CONFIguration.....	581
[:SOURce<hw>]:BB:EUTRa:DL:MIMO:ANTenna.....	581
[:SOURce<hw>]:BB:EUTRa:DL:MIMO:APM:MAPCoordinates.....	581
[:SOURce<hw>]:BB:EUTRa:DL:MIMO:APM:CS:CELL:BB<st0>.....	581
[:SOURce<hw>]:BB:EUTRa:DL:MIMO:APM:CS:AP<dir0>:ROW<st0>:REAL.....	582
[:SOURce<hw>]:BB:EUTRa:DL:MIMO:APM:CS:AP<dir0>:ROW<st0>:IMAGinary.....	582
[:SOURce<hw>]:BB:EUTRa:DL:REFSig:POWer.....	583
[:SOURce<hw>]:BB:EUTRa:DL:REFSig:EPRE?.....	583
[:SOURce<hw>]:BB:EUTRa:DL:SYNC:TXAntenna.....	584
[:SOURce<hw>]:BB:EUTRa:DL:SYNC:PPOWer.....	584

<code>[:SOURce<hw>]:BB:EUTRa:DL:SYNC:SPOWer</code>	584
<code>[:SOURce<hw>]:BB:EUTRa:DL:BW</code>	584
<code>[:SOURce<hw>]:BB:EUTRa:DL:NORB</code>	585
<code>[:SOURce<hw>]:BB:EUTRa:DL:SRATe?</code>	585
<code>[:SOURce<hw>]:BB:EUTRa:DL:FFT</code>	585
<code>[:SOURce<hw>]:BB:EUTRa:DL:OCCBandwidth?</code>	586
<code>[:SOURce<hw>]:BB:EUTRa:DL:OCCSubcarriers?</code>	586
<code>[:SOURce<hw>]:BB:EUTRa:DL:LGS?</code>	586
<code>[:SOURce<hw>]:BB:EUTRa:DL:RGS?</code>	586
<code>[:SOURce<hw>]:BB:EUTRa:DL[:PLCI]:CID</code>	587
<code>[:SOURce<hw>]:BB:EUTRa:DL[:PLCI]:CIDGroup</code>	587
<code>[:SOURce<hw>]:BB:EUTRa:DL[:PLCI]:PLID</code>	587
<code>[:SOURce<hw>]:BB:EUTRa:DL:CSETtings:RARNTi</code>	588
<code>[:SOURce<hw>]:BB:EUTRa:DL:CPC</code>	588
<code>[:SOURce<hw>]:BB:EUTRa:DL:ULCPc</code>	588
<code>[:SOURce<hw>]:BB:EUTRa:DL:PDSCh:PB</code>	588
<code>[:SOURce<hw>]:BB:EUTRa:DL:PDSCh:RATBa</code>	589
<code>[:SOURce<hw>]:BB:EUTRa:DL:PDCCh:RATBa</code>	589
<code>[:SOURce<hw>]:BB:EUTRa:DL:PBCH:RATBa</code>	589
<code>[:SOURce<hw>]:BB:EUTRa:DL:PRSS:BW</code>	589
<code>[:SOURce<hw>]:BB:EUTRa:DL:PRSS:CI</code>	589
<code>[:SOURce<hw>]:BB:EUTRa:DL:PRSS:DPRS?</code>	590
<code>[:SOURce<hw>]:BB:EUTRa:DL:PRSS:NPRS</code>	590
<code>[:SOURce<hw>]:BB:EUTRa:DL:PRSS:POW</code>	590
<code>[:SOURce<hw>]:BB:EUTRa:DL:PRSS:STATE</code>	591
<code>[:SOURce<hw>]:BB:EUTRa:DL:PRSS:TPRS?</code>	591
<code>[:SOURce<hw>]:BB:EUTRa:DL:PRSS:MIPattern</code>	591

`[:SOURce<hw>]:BB:EUTRa:DL:CONF:MODE <Scheduling>`

Determines how the scheduling of the different PDSCH allocations inside of the DL allocation table is performed.

Parameters:

<Scheduling>

MANual | AUTO | ASEquence

MANual

No cross-reference between the settings made for the PDCCH DCIs and the PDSCHs settings.

Configure the PDSCH allocations manually.

AUTO

Precoding for spatial multiplexing according to [TS 36.211](#) and the selected parameters.

ASEquence

According to the required HARQ processes and redundancy versions

*RST: MANual

Example: `BB:EUTR:DL:CONF:MODE AUTO`
enables the generation of 3GPP compliant EUTRA/LTE signal and the PDSCH allocations are configured automatically according to the configuration of the PDCCH DCIs.

Options: ASEquence requires R&S SMM-K112

Manual operation: See [Chapter 4.2.1, "PDSCH scheduling settings"](#), on page 69

[:SOURce<hw>]:BB:EUTRa:DL:MIMO:CONFIguration <Configuration>

Sets the global MIMO configuration.

Parameters:

<Configuration> TX1 | TX2 | TX4 | SIBF
*RST: TX1

Example: `SOURce1:BB:EUTRa:DL:MIMO:CONFIguration TX2`
`SOURce1:BB:EUTRa:DL:MIMO:ANTenna ANT1`
`SOURce1:BB:EUTRa:DL:MIMO:APM:MAPCoordinates CARTesian`
`SOURce1:BB:EUTRa:DL:MIMO:APM:CS:AP0:ROW0:REAL 1`

Manual operation: See ["Global MIMO Configuration"](#) on page 125

[:SOURce<hw>]:BB:EUTRa:DL:MIMO:ANTenna <Antenna>

Sets the simulated antenna.

Parameters:

<Antenna> ANT1 | ANT2 | ANT3 | ANT4
*RST: ANT1

Example: See [\[:SOURce<hw>\]:BB:EUTRa:DL:MIMO:CONFIguration](#) on page 581

Manual operation: See ["Simulated Antenna"](#) on page 126

[:SOURce<hw>]:BB:EUTRa:DL:MIMO:APM:MAPCoordinates <Type>

Switches between the cartesian and cylindrical coordinates representation.

Parameters:

<Type> CARTesian | CYLindrical
*RST: CARTesian

Example: See [\[:SOURce<hw>\]:BB:EUTRa:DL:MIMO:CONFIguration](#) on page 581

Manual operation: See ["Mapping Coordinates"](#) on page 216

[:SOURce<hw>]:BB:EUTRa:DL:MIMO:APM:CS:CELL:BB<st0> <AntPortCCIndex>

Maps a component carrier to a baseband.

Parameters:

<AntPortCCIndex> PC | SC1 | SC2 | SC3 | SC4
 Component carrier
 *RST: PC

Manual operation: See "[Mapping table](#)" on page 216

[:SOURce<hw>]:BB:EUTRa:DL:MIMO:APM:CS:AP<dir0>:ROW<st0>:REAL
 <AntPortMapDat>

Define the mapping of the antenna ports to the physical antennas.

Suffix:

<dir0> 0 | 1 | 2 | 3 | 4 | 6 | 15 to 46 | 2000 to 2001
 Antenna port

Parameters:

<AntPortMapDat> 0 | 1 (for AP = 0 to 3); float (for AP = 4 | 6 | 15 to 46)

To map an AP, use the command

SOURce1:BB:EUTRa:DL:MIMO:APM:CS:AP0|1|2|3:

ROW0|1|2|3:REAL 1. The correspond-

ing . . . :CS:AP0|1|2|3:ROW0|1|2|3:IMAG command has no effect.

The REAL (Magnitude) and IMAGinary (Phase) values are interdependent. Their value ranges change depending on each other and so that the resulting complex value is as follows:

$|\text{REAL} + j \text{IMAGinary}| \leq 1$

Otherwise, the values are normalized to Magnitude = 1.

Range: -1 to 360

Increment: 0.001

*RST: dynamic

Example: See [\[:SOURce<hw>\]:BB:EUTRa:DL:MIMO:CONFiguration](#) on page 581.

Options: AP = 23 to 46 require R&S SMM-119
 AP = 2000/2001 require R&S SMM-143

Manual operation: See "[Mapping table](#)" on page 216

[:SOURce<hw>]:BB:EUTRa:DL:MIMO:APM:CS:AP<dir0>:ROW<st0>:IMAGinary
 <AntPortMapDat>

Define the mapping of the antenna ports to the physical antennas.

Suffix:

<dir0> 4 | 6 | 15 to 46 | 2000 to 2001
 Antenna port

Parameters:`<AntPortMapDat>` float

The REAL (Magnitude) and IMAGinary (Phase) values are interdependent. Their value ranges change depending on each other and so that the resulting complex value is as follows:

$$|\text{REAL} + j \cdot \text{IMAGinary}| \leq 1$$

Otherwise, the values are normalized to Magnitude = 1.

Range: -1 to 360

Increment: 0.001

*RST: dynamic

Example:

See `[:SOURce<hw>] :BB:EUTRa:DL:MIMO:CONFIguration` on page 581.

Options:

AP = 23 to 46 require R&S SMM-119

AP = 2000/2001 require R&S SMM-143

Manual operation:See "[Mapping table](#)" on page 216

`[:SOURce<hw>] :BB:EUTRa:DL:REFSig:POWER <Power>`

Sets the reference signal power.

Parameters:`<Power>` float

Range: -80 to 10

Increment: 0.01

*RST: 0

Example:

`SOURce1:BB:EUTRa:DL:REFSig:POWER -10.00`

Manual operation:See "[Reference Signal Power](#)" on page 102

`[:SOURce<hw>] :BB:EUTRa:DL:REFSig:EPRE?`

Queries the RS Power per RE relative to Level Display.

Return values:`<RelToLevelDispl>` float

Range: -1e3 to 1e3

Increment: 0.001

*RST: 0

Example:

`BB:EUTRa:DL:REFSig:EPRE?`

Queries the RS Power per RE relative to Level Display.

Usage:

Query only

Manual operation:See "[RS Power per RE relative to Level Display](#)" on page 102

[[:SOURce<hw>]:BB:EUTRa:DL:SYNC:TXANtenna <TxAntenna>

Defines on which antenna port the P-/S-SYNC is transmitted.

The available values depend on the number of configured antennas.

Parameters:

<TxAntenna> NONE | ANT1 | ANT2 | ANT3 | ANT4 | ALL
*RST: ALL

Example:

BB:EUTR:DL:SYNC:TXAN ALL
Enables all antenna ports to transmit P-/S-SYNC

Manual operation: See "[P-/S-SYNC Tx Antenna](#)" on page 103

[[:SOURce<hw>]:BB:EUTRa:DL:SYNC:PPOWer <PPower>

Sets the power of the primary synchronization signal (P-SYNC).

Parameters:

<PPower> float
Range: -80 to 10
Increment: 0.001
*RST: 0

Example:

BB:EUTR:DL:SYNC:PPOWer -10.00
Sets the P-SYNC power to -10.00dB.

Manual operation: See "[P-SYNC Power](#)" on page 103

[[:SOURce<hw>]:BB:EUTRa:DL:SYNC:SPOWer <SPower>

Sets the power of the secondary synchronization signal (S-SYNC).

Parameters:

<SPower> float
Range: -80 to 10
Increment: 0.001
*RST: 0

Example:

BB:EUTR:DL:SYNC:SPOWer -10.00
Sets the S-SYNC power to -10.00dB.

Manual operation: See "[S-SYNC Power](#)" on page 103

[[:SOURce<hw>]:BB:EUTRa:DL:BW <Bw>

Sets the DL channel bandwidth.

Parameters:

<Bw> BW1_40 | BW3_00 | BW5_00 | BW10_00 | BW15_00 |
BW20_00 | BW0_20 | USER
*RST: BW10_00

- Example:** See [Example "NB-IoT anchor carrier in standalone mode"](#) on page 799.
- Options:** BW0_20 requires R&S SMM-K115
USER requires R&S SMM-K55
- Manual operation:** See ["Channel Bandwidth"](#) on page 93

[:SOURce<hw>]:BB:EUTRa:DL:NORB <Norb>

Selects the number of physical resource blocks per slot.

Parameters:

<Norb> integer
Range: 6 to 110
*RST: 50

Example: SOURce1:BB:EUTRa:DL:BW USER
SOURce1:BB:EUTRa:DL:NORB 7

Example: SOURce1:BB:EUTRa:DL:BW BW5_00
SOURce1:BB:EUTRa:DL:NORB?
// 25

Manual operation: See ["Number of Resource Blocks Per Slot"](#) on page 94

[:SOURce<hw>]:BB:EUTRa:DL:SRATe?

Queries the sampling rate.

Return values:

<SampleRate> float
Range: 192E4 to 3072E4
Increment: 1000
*RST: 1536E4

Example: BB:EUTRa:DL:SRATe?
Queries the automatically set sampling rate.

Usage: Query only

Manual operation: See ["Sampling Rate"](#) on page 96

[:SOURce<hw>]:BB:EUTRa:DL:FFT <Fft>

Sets the FFT size.

Parameters:

<Fft> integer
Range: 64 to 2048
*RST: 1024

Example: SOURce1:BB:EUTRa:DL:FFT?

Manual operation: See ["FFT Size"](#) on page 94

[:SOURCE<hw>]:BB:EUTRa:DL:OCCBandwidth?

Queries the occupied bandwidth.

Return values:

<OccupBandwidth> float

Example:

BB:EUTRa:DL:OCCB?

Queries the automatically set occupied bandwidth in downlink.

Usage:

Query only

Manual operation: See ["Occupied Bandwidth"](#) on page 95

[:SOURCE<hw>]:BB:EUTRa:DL:OCCSubcarriers?

Queries the occupied subcarriers.

Return values:

<OccupSubcarr> integer

Range: 72 to 1321

*RST: 601

Example:

BB:EUTRa:DL:OCCS?

Queries the number of occupied subcarriers.

Usage:

Query only

Manual operation: See ["Number Of Occupied Subcarriers"](#) on page 96

[:SOURCE<hw>]:BB:EUTRa:DL:LGS?

Queries the number of left guard subcarriers.

Return values:

<Lgs> integer

Range: 28 to 364

*RST: 212

Example:

BB:EUTRa:DL:LGS?

Queries the number of left guard subcarriers.

Usage:

Query only

Manual operation: See ["Number Of Left/Right Guard Subcarriers"](#) on page 96

[:SOURCE<hw>]:BB:EUTRa:DL:RGS?

Queries the number of right guard subcarriers.

Return values:

<Rgs> integer
 Range: 27 to 364
 *RST: 211

Example:

BB:EUTR:DL:RGS?
 Queries the number of right guard subcarriers.

Usage:

Query only

Manual operation: See ["Number Of Left/Right Guard Subcarriers"](#) on page 96

[:SOURCE<hw>]:BB:EUTRa:DL[:PLCI]:CID <CellId>

Sets the cell identity.

Parameters:

<CellId> integer
 Range: 0 to 503
 *RST: 0

Example:

BB:EUTR:DL:PLC:CID 100
 Sets the Cell ID.

Manual operation: See ["Cell ID"](#) on page 97

[:SOURCE<hw>]:BB:EUTRa:DL[:PLCI]:CIDGroup <CellIdGroup>

Sets the ID of the physical cell identity group.

Parameters:

<CellIdGroup> integer
 Range: 0 to 167
 *RST: 0

Example:

BB:EUTR:DL:PLC:CIDG 100
 Sets the ID of the physical cell identity group.

Manual operation: See ["Physical Cell ID Group"](#) on page 97

[:SOURCE<hw>]:BB:EUTRa:DL[:PLCI]:PLID <PhysLayId>

Sets the identity of the physical layer within the selected physical cell identity group, set with the command [\[:SOURCE<hw>\]:BB:EUTRa:DL\[:PLCI\]:CIDGroup](#).

Parameters:

<PhysLayId> integer
 Range: 0 to 2
 *RST: 0

Example:

BB:EUTR:DL:PLC:PLID 2
 Sets the identity of the physical layer.

Manual operation: See ["Physical Layer ID"](#) on page 97

[:SOURCE<hw>]:BB:EUTRa:DL:CSETtings:RARnti <RaRnti>

Sets the random-access response identity RA-RNTI.

The value selected here determines the value of the parameter "UE_ID/n_RNTI" in case a RA_RNTI "User" is selected.

Parameters:

<RaRnti> integer
 Range: 1 to 60
 *RST: 1

Example: SOURCE1:BB:EUTRa:DL:CSETtings:RARnti 5

Manual operation: See ["RA_RNTI"](#) on page 100

[:SOURCE<hw>]:BB:EUTRa:DL:CPC <CyclicPrefix>

Sets the cyclic prefix length for all LTE subframes.

Parameters:

<CyclicPrefix> NORMAl | EXTENDED | USER
 *RST: NORMAl

Example: SOURCE1:BB:EUTRa:DL:CPC NORM

Example: SOURCE1:BB:EUTRa:DL:CPC USER
 SOURCE1:BB:EUTRa:DL:SUBF6:CYCP NORM
 SOURCE1:BB:EUTRa:DL:SUBF1:CYCP EXT

Manual operation: See ["Cyclic Prefix \(General DL Settings\)"](#) on page 98

[:SOURCE<hw>]:BB:EUTRa:DL:ULCPC <GSCpcOppDir>

In TDD duplexing mode, sets the cyclic prefix for the opposite direction.

Parameters:

<GSCpcOppDir> NORMAl | EXTENDED
 *RST: NORMAl

Example: :SOURCE1:BB:EUTRa:DUPLexing TDD
 :SOURCE1:BB:EUTRa:DL:ULCPC EXTENDED

Manual operation: See ["UL/DL Cyclic Prefix"](#) on page 98

[:SOURCE<hw>]:BB:EUTRa:DL:PDSCCh:PB <Pb>

Sets the cell-specific ratio ρ_B/ρ_A according to [TS 36.213](#).

Parameters:

<Pb> integer
 Range: 0 to 3
 *RST: 0

Example: See [:SOURce<hw>] :BB:EUTRa:DL:PBCH:RATBa on page 589.

Manual operation: See "PDSCH P_B" on page 98

[:SOURce<hw>] :BB:EUTRa:DL:PDSCh:RATBa <RatioPbPa>
[:SOURce<hw>] :BB:EUTRa:DL:PDCCh:RATBa <RatioPbBa>
[:SOURce<hw>] :BB:EUTRa:DL:PBCH:RATBa <RatioPbPa>

Sets the transmit energy ratio among the resource elements allocated for the channel in the OFDM symbols containing reference signal (P_B) and such not containing one (P_A).

Parameters:

<RatioPbPa> float
 Range: -10 to 10
 Increment: 0.001
 *RST: 0

Example:

```
SOURce1:BB:EUTRa:DL:PDSCh:PB 1
SOURce1:BB:EUTRa:DL:PDSCh:RATBa?
// -0.969
SOURce1:BB:EUTRa:DL:PBCH:RATBa -5.0
SOURce1:BB:EUTRa:DL:PDCCh:RATBa -1.0
```

Manual operation: See "PDSCH/PDCCH/PBCH Ratio rho_B/rho_A" on page 98

[:SOURce<hw>] :BB:EUTRa:DL:PRSS:BW <PrsBandwidth>

Defines the bandwidth in which the PRS is transmitted.

Parameters:

<PrsBandwidth> BW1_40 | BW3_00 | BW5_00 | BW10_00 | BW15_00 |
 BW20_00
 *RST: BW1_40

Example: See [:SOURce<hw>] :BB:EUTRa:DL:PRSS:STATE on page 591

Manual operation: See "PRS Bandwidth" on page 108

[:SOURce<hw>] :BB:EUTRa:DL:PRSS:CI <ConfIdx>

Sets the PRS Configuration Index I_{PRS} as defined in 3GPP TS 36.211, table 6.10.4.3-1.

Parameters:

<ConfIdx> integer
 Range: 0 to 2399
 *RST: 0

Example: See [:SOURce<hw>] :BB:EUTRa:DL:PRSS:STATE on page 591

Manual operation: See "PRS Configuration Index" on page 107

[:SOURce<hw>] :BB:EUTRa:DL:PRSS:DPRS?

Queries the subframe offset of the PRS generation (Δ_{PRS}) as defined in 3GPP TS 36.211, table 6.10.4.3-1.

Return values:

<DeltaPRS> integer
 Range: 0 to 1279
 *RST: 0

Example: See [:SOURce<hw>] :BB:EUTRa:DL:PRSS:STATE on page 591

Usage: Query only

Manual operation: See "PRS Subframe offset Delta_PRS" on page 107

[:SOURce<hw>] :BB:EUTRa:DL:PRSS:NPRS <NumberPRS>

Defines the number of consecutive DL subframes in that PRS are transmitted.

Parameters:

<NumberPRS> 1 | 2 | 4 | 6
 *RST: 1

Example: See [:SOURce<hw>] :BB:EUTRa:DL:PRSS:STATE on page 591

Options: R&S SMM-K84

Manual operation: See "Number of PRS DL Subframes (N_PRS)" on page 108

[:SOURce<hw>] :BB:EUTRa:DL:PRSS:POW <PrsPower>

Sets the power of a PRS resource element relative to the power of a common reference signal resource element.

Parameters:

<PrsPower> float
 Range: -80 to 10
 Increment: 0.001
 *RST: 0

Example: See `[:SOURce<hw>] :BB:EUTRa:DL:PRSS:STATe` on page 591

Manual operation: See "PRS Power" on page 108

[:SOURce<hw>] :BB:EUTRa:DL:PRSS:STATe <PrsState>

Enables the generation of the PRS.

Parameters:

<PrsState> 1 | ON | 0 | OFF
*RST: OFF

Example:

```
:SOURce1:BB:EUTRa:DL:PRSS:CI 1
:SOURce1:BB:EUTRa:DL:PRSS:BW BW1_40
:SOURce1:BB:EUTRa:DL:PRSS:POW 0
:SOURce1:BB:EUTRa:DL:PRSS:MIPattern #H1,2
:SOURce1:BB:EUTRa:DL:PRSS:NPRS 2
:SOURce1:BB:EUTRa:DL:PRSS:STATe 1
```

Manual operation: See "PRS State" on page 107

[:SOURce<hw>] :BB:EUTRa:DL:PRSS:TPRS? <PeriodicityTPRS>

Queries the periodicity of the PRS generation (T_{PRS}) as defined in 3GPP TS 36.211, table 6.10.4.3-1.

Parameters:

<PeriodicityTPRS> integer
Range: 160 to 1280
*RST: 160

Example: See `[:SOURce<hw>] :BB:EUTRa:DL:PRSS:STATe` on page 591

Usage: Query only

Manual operation: See "PRS Periodicity T_{PRS} " on page 107

[:SOURce<hw>] :BB:EUTRa:DL:PRSS:MIPattern <PrsMutingInfo>, <BitCount>

Specifies a bit pattern that defines the muted and not muted PRS.

Parameters:

<PrsMutingInfo> numeric
Each bit defines the PRS state of one PRS occasion
0
PRS is muted
1
PRS is transmitted
*RST: #H3

<BitCount>	integer 2, 4, 8 or 16 bits Range: 2 to 16 *RST: 2
Example:	See [:SOURce<hw>] :BB:EUTRa:DL:PRSS:STATe on page 591
Manual operation:	See "PRS Muting Info" on page 108

10.9 General uplink commands

[:SOURce<hw>] :BB:EUTRa:UL:BW.....	593
[:SOURce<hw>] :BB:EUTRa:UL:NORB.....	593
[:SOURce<hw>] :BB:EUTRa:UL:SRATe?.....	593
[:SOURce<hw>] :BB:EUTRa:UL:FFT.....	594
[:SOURce<hw>] :BB:EUTRa:UL:OCCBandwidth?.....	594
[:SOURce<hw>] :BB:EUTRa:UL:OCCSubcarriers?.....	594
[:SOURce<hw>] :BB:EUTRa:UL:LGS?.....	594
[:SOURce<hw>] :BB:EUTRa:UL:RGS?.....	595
[:SOURce<hw>] :BB:EUTRa:UL[:PLCI]:CID.....	595
[:SOURce<hw>] :BB:EUTRa:UL[:PLCI]:CIDGroup.....	595
[:SOURce<hw>] :BB:EUTRa:UL[:PLCI]:PLID.....	596
[:SOURce<hw>] :BB:EUTRa:UL:CPC.....	596
[:SOURce<hw>] :BB:EUTRa:UL:DLCPc.....	596
[:SOURce<hw>] :BB:EUTRa:UL:SOFFset.....	596
[:SOURce<hw>] :BB:EUTRa:UL:REFSig:GRPHopping.....	597
[:SOURce<hw>] :BB:EUTRa:UL:REFSig:SEQHopping.....	597
[:SOURce<hw>] :BB:EUTRa:UL:REFSig:DSSHift.....	597
[:SOURce<hw>] :BB:EUTRa:UL:REFSig:DMRS.....	598
[:SOURce<hw>] :BB:EUTRa:UL:REFSig:SRS:ANSTx.....	598
[:SOURce<hw>] :BB:EUTRa:UL:REFSig:SRS:MUPTs.....	598
[:SOURce<hw>] :BB:EUTRa:UL:REFSig:SRS:CSRS.....	598
[:SOURce<hw>] :BB:EUTRa:UL:REFSig:SRS:DSFC?.....	599
[:SOURce<hw>] :BB:EUTRa:UL:REFSig:SRS:SUConfiguration.....	599
[:SOURce<hw>] :BB:EUTRa:UL:REFSig:SRS:TSFC?.....	599
[:SOURce<hw>] :BB:EUTRa:UL:PRACH:CONFIguration.....	600
[:SOURce<hw>] :BB:EUTRa:UL:PRACH:FOFFset.....	600
[:SOURce<hw>] :BB:EUTRa:UL:PRACH:RSET.....	600
[:SOURce<hw>] :BB:EUTRa:UL:PUSCh:FHMode.....	600
[:SOURce<hw>] :BB:EUTRa:UL:PUSCh:FHOFFset.....	601
[:SOURce<hw>] :BB:EUTRa:UL:PUSCh:NOSM.....	601
[:SOURce<hw>] :BB:EUTRa:UL:PUCCh:NORB.....	601
[:SOURce<hw>] :BB:EUTRa:UL:PUCCh:DESHift.....	602
[:SOURce<hw>] :BB:EUTRa:UL:PUCCh:N1CS.....	602
[:SOURce<hw>] :BB:EUTRa:UL:PUCCh:N2RB.....	602
[:SOURce<hw>] :BB:EUTRa:UL:PUCCh:N1NMax?.....	603
[:SOURce<hw>] :BB:EUTRa:UL:PUCCh:N1EMax?.....	603

<code>[:SOURce<hw>]:BB:EUTRa:UL:PUCCh:N2Max?</code>	603
<code>[:SOURce<hw>]:BB:EUTRa:UL:PUCCh:N5Max?</code>	604
<code>[:SOURce<hw>]:BB:EUTRa:UL:PUCCh:N4Max?</code>	604
<code>[:SOURce<hw>]:BB:EUTRa:UL:PUCCh:N3Max?</code>	604

`[:SOURce<hw>]:BB:EUTRa:UL:BW <BandWidth>`

Sets the UL channel bandwidth.

Parameters:

`<BandWidth>` `BW1_40 | BW3_00 | BW5_00 | BW10_00 | BW15_00 |`
`BW20_00 | BW0_20 | USER`
***RST:** `BW10_00`

Example: `SOURce:BB:EUTRa:UL:BW BW20_00`

Options: `BW0_20` requires R&S SMM-K115
`USER` requires R&S SMM-K55

Manual operation: See "[Channel Bandwidth](#)" on page 226

`[:SOURce<hw>]:BB:EUTRa:UL:NORB <NumResBlocks>`

Selects the number of physical resource blocks per slot.

Parameters:

`<NumResBlocks>` integer
Range: 6 to 110
***RST:** 50

Example: `BB:EUTRa:UL:BW USER`
 Sets the bandwidth mode to USER in downlink.
`BB:EUTRa:UL:NORB 7`
 Sets the number of resource blocks to 7.

Manual operation: See "[Number of Resource Blocks Per Slot](#)" on page 227

`[:SOURce<hw>]:BB:EUTRa:UL:SRATe?`

Queries the sampling rate.

Return values:

`<SampRate>` float
Range: 192E4 to 3072E4
Increment: 1000
***RST:** 1536E4

Example: `BB:EUTRa:UL:SRATe?`
 Queries the automatically set sampling rate.

Usage: Query only

Manual operation: See "[Sampling Rate](#)" on page 228

[:SOURCE<hw>]:BB:EUTRa:UL:FFT <FftSize>

Sets the FFT (Fast Fourier Transformation) size. The available values depend on the selected number of resource blocks per slot.

Parameters:

<FftSize> integer
 Range: 64 to 2048
 *RST: 1024

Example: BB:EUTRa:UL:FFT?
 Queries the automatically set FFT size.

Manual operation: See "[FFT Size](#)" on page 227

[:SOURCE<hw>]:BB:EUTRa:UL:OCCBandwidth?

Queries the occupied bandwidth. This value is set automatically according to the selected number of resource blocks per slot.

Return values:

<OccBandwidth> float
 Default unit: MHz

Example: BB:EUTRa:UL:OCCB?
 Queries the automatically set occupied bandwidth in uplink.

Usage: Query only

Manual operation: See "[Occupied Bandwidth](#)" on page 228

[:SOURCE<hw>]:BB:EUTRa:UL:OCCSubcarriers?

Queries the occupied subcarriers. The value is set automatically according to the selected number of resource blocks per slot.

Return values:

<OccSubcarriers> integer
 Range: 72 to 1320
 *RST: 600

Example: BB:EUTRa:UL:OCCS?
 Queries the number of occupied subcarriers.

Usage: Query only

Manual operation: See "[Number Of Occupied Subcarriers](#)" on page 229

[:SOURCE<hw>]:BB:EUTRa:UL:LGS?

Queries the number of left guard subcarriers. The value is set automatically according to the selected number of resource blocks per slot.

Return values:

<LgSubCarr> integer
 Range: 28 to 364
 *RST: 212

Example:

BB:EUTR:UL:LGS?
 Queries the number of left guard subcarriers.

Usage: Query only

Manual operation: See ["Number of Left/Right Guard Subcarriers"](#) on page 229

[:SOURCE<hw>]:BB:EUTRa:UL:RGS?

Queries the number of right guard subcarriers. The value is set automatically according to the selected number of resource blocks per slot.

Return values:

<RgSubCarr> integer
 Range: 35 to 601
 *RST: 211

Example:

BB:EUTR:UL:RGS?
 Queries the number of right guard subcarriers.

Usage: Query only

Manual operation: See ["Number of Left/Right Guard Subcarriers"](#) on page 229

[:SOURCE<hw>]:BB:EUTRa:UL[:PLCI]:CID <CellId>

Sets the cell identity.

Parameters:

<CellId> integer
 Range: 0 to 503
 *RST: 0

Example:

BB:EUTR:UL:PLC:CID 100
 Sets the cell ID.

Manual operation: See ["Cell ID"](#) on page 230

[:SOURCE<hw>]:BB:EUTRa:UL[:PLCI]:CIDGroup <PhysCellIdGroup>

Sets the ID of the physical cell identity group.

Parameters:

<PhysCellIdGroup> integer
 Range: 0 to 167
 *RST: 0

Example: BB:EUTR:UL:PLC:CIDG 100
Sets the UL physical cell ID group

Manual operation: See ["Physical Cell ID Group"](#) on page 230

[:SOURCE<hw>]:BB:EUTRa:UL[:PLCI]:PLID <PhysicalLayerId>

Sets the identity of the physical layer within the selected physical cell identity group, set with the command `[:SOURCE<hw>]:BB:EUTRa:UL[:PLCI]:CIDGroup`.

Parameters:

<PhysicalLayerId> integer
Range: 0 to 2
*RST: 0

Example: BB:EUTR:UL:PLC:PLID 2
Sets the UL physical layer ID

Manual operation: See ["Physical Layer ID"](#) on page 230

[:SOURCE<hw>]:BB:EUTRa:UL:CPC <CyclicPrefix>

Sets the cyclic prefix length for all subframes.

Parameters:

<CyclicPrefix> NORMAl | EXTended | USER
*RST: NORMAl

Example: SOURCE1:BB:EUTRa:UL:CPC NORM

Options: R&S SMM-K55: USER

Manual operation: See ["Cyclic Prefix"](#) on page 230

[:SOURCE<hw>]:BB:EUTRa:UL:DLCPc <GSCpcOppDir>

In TDD mode, determines the cyclic prefix for the appropriate opposite direction.

Parameters:

<GSCpcOppDir> NORMAl | EXTended
*RST: NORMAl

Example: :SOURCE1:BB:EUTRa:DUPLexing TDD
:SOURCE1:BB:EUTRa:UL:DLCPc EXTended

Manual operation: See ["UL/DL Cyclic Prefix"](#) on page 98

[:SOURCE<hw>]:BB:EUTRa:UL:SOFFset <SfnOffset>

Set the start SFN value.

Parameters:

<SfnOffset> integer
 Range: 0 to 4095
 *RST: 0
 Default unit: Frames

Example: :SOURce1:BB:EUTRa:UL:SOFFset 10
 Sets the SFN start value

Manual operation: See "[SFN Offset](#)" on page 231

[SOURce<hw>]:BB:EUTRa:UL:REFSig:GRPHopping <GroupHopping>

Enables/disables group hopping for the uplink reference signals demodulation reference signal (DMRS) and sounding reference signal (SRS).

Parameters:

<GroupHopping> 1 | ON | 0 | OFF
 *RST: 0

Example: BB:EUTR:UL:REFS:GRPH ON
 Enables group hopping

Manual operation: See "[Group Hopping](#)" on page 234

[SOURce<hw>]:BB:EUTRa:UL:REFSig:SEQHopping <SequenceHopping>

Enables/disables sequence hopping for the uplink reference signals demodulation reference signal (DMRS) and sounding reference signal (SRS).

Parameters:

<SequenceHopping> 1 | ON | 0 | OFF
 *RST: OFF

Example: BB:EUTR:UL:REFS:SEQH ON
 Enables sequence hopping

Manual operation: See "[Sequence Hopping](#)" on page 234

[SOURce<hw>]:BB:EUTRa:UL:REFSig:DSSHift <DeltaSeqShift>

Sets the delta sequence shift for PUSCH needed for the calculation of the group hopping pattern.

Parameters:

<DeltaSeqShift> integer
 Range: 0 to 29
 *RST: 0

Example: BB:EUTR:UL:REFS:DSSH 3
 Sets the delta sequence shift for PUSCH

Manual operation: See "[Delta Sequence Shift for PUSCH](#)" on page 235

[:SOURce<hw>]:BB:EUTRa:UL:REFSig:DMRS <DrsDmrs>

Sets the part of the demodulation reference signal (DMRS) index which is broadcasted and therefore valid for the whole cell. This index applies when multiple shifts within a cell are used and is used by the calculation of the DMRS sequence.

Parameters:

<DrsDmrs> integer
 Range: 0 to 11
 *RST: 0

Example: BB:EUTR:UL:REFS:DMRS 4
 Sets the demodulation reference signal index to 4

Manual operation: See "[n\(1\)_DMRS](#)" on page 235

[:SOURce<hw>]:BB:EUTRa:UL:REFSig:SRS:ANSTx <AnSrsSimTxState>

Enables/disables simultaneous transmission of SRS (sounding reference signal) and ACK/NACK messages, i.e. transmission of SRS and PUCCH in the same subframe.

Parameters:

<AnSrsSimTxState> 1 | ON | 0 | OFF
 *RST: OFF

Example: BB:EUTR:UL:REFS:SRS:ANST ON

Manual operation: See "[A/N + SRS simultaneous Tx](#)" on page 236

[:SOURce<hw>]:BB:EUTRa:UL:REFSig:SRS:MUPTs <MaxUpPts>

Enables/disables the cell-specific parameter srsMaxUpPts.

Parameters:

<MaxUpPts> 1 | ON | 0 | OFF
 *RST: OFF

Example: BB:EUTR:UL:REFS:SRS:MUPT ON

Manual operation: See "[SRS MaxUpPTS](#)" on page 236

[:SOURce<hw>]:BB:EUTRa:UL:REFSig:SRS:CSRS <Csrs>

Sets the cell-specific parameter SRS bandwidth configuration (C_{SRS}).

Parameters:

<Csrs> integer
 Range: 0 to 7
 *RST: 0

Example: BB:EUTR:UL:REFS:SRS:CSRS 4
 Sets the SRS bandwidth configuration

Manual operation: See ["SRS Bandwidth Configuration C_SRS"](#) on page 236

[:SOURce<hw>]:BB:EUTRa:UL:REFSig:SRS:DSFC?

Queries the value for the cell-specific parameter transmission offset Δ_{SFC} in sub-frames, depending on the selected SRS subframe configuration (`[:SOURce<hw>]:BB:EUTRa:UL:REFSig:SRS:CSRS`) and the duplexing mode (`[:SOURce<hw>]:BB:EUTRa:DUPLexing`).

Return values:

<DeltSFC> string

Example: `BB:EUTR:UL:REFS:SRS:SUC 4`
Sets the SRS configuration
`BB:EUTR:UL:REFS:SRS:DSFC?`
Queries the Δ_{SFC} parameter

Usage: Query only

Manual operation: See ["Transmission Offset \$\Delta_{SFC}\$ "](#) on page 236

[:SOURce<hw>]:BB:EUTRa:UL:REFSig:SRS:SUConfiguration <SubFrameConfig>

Sets the cell-specific parameter SRS subframe configuration.

Parameters:

<SubFrameConfig> integer
Range: 0 to 15
*RST: 15

Example: `BB:EUTR:UL:REFS:SRS:SUC 4`
Sets the SRS configuration

Manual operation: See ["SRS Subframe Configuration"](#) on page 236

[:SOURce<hw>]:BB:EUTRa:UL:REFSig:SRS:TSFC?

Queries the value for the cell-specific parameter configuration period T_{SFC} in sub-frames, depending on the selected SRS subframe configuration (`[:SOURce<hw>]:BB:EUTRa:UL:REFSig:SRS:CSRS`) and the duplexing mode (`[:SOURce<hw>]:BB:EUTRa:DUPLexing`).

Return values:

<Tsfc> string

Example: `BB:EUTR:UL:REFS:SRS:SUC 4`
Sets the SRS configuration
`BB:EUTR:UL:REFS:SRS:TSFC?`
Queries the T_{SFC} parameter

Usage: Query only

Manual operation: See ["Configuration Period \$T_{SFC}\$ "](#) on page 236

[:SOURce<hw>]:BB:EUTRa:UL:PRACH:CONFIguration <Configuration>

Sets the PRACH configuration number.

Parameters:

<Configuration> integer
 Range: 0 to 63
 *RST: 0

Example: BB:EUTRa:UL:PRACH:CONF 10
 Sets the PRACH configuration

Manual operation: See "[PRACH Configuration](#)" on page 237

[:SOURce<hw>]:BB:EUTRa:UL:PRACH:FOFFset <FrequencyOffset>

Sets the prach-FrequencyOffset $n_{PRBOffset}^{RA}$

Parameters:

<FrequencyOffset> integer
 Range: 0 to dynamic
 *RST: 0

Example: BB:EUTRa:UL:PRACH:FOFF 2
 Sets the frequency offset

Manual operation: See "[PRACH Frequency Offset](#)" on page 237

[:SOURce<hw>]:BB:EUTRa:UL:PRACH:RSET <RestrictedSet>

Enables/disables using of a restricted preamble set.

Parameters:

<RestrictedSet> URES | ARES | BRES | OFF | ON
URES|OFF
 Unrestricted preamble set.
ARES|ON
 Restricted set type A.
BRES
 Restricted set type B.
 *RST: URES

Example: SOURce1:BB:EUTRa:UL:PRACH:RSET ARES
 Enables using of restricted set type A

Manual operation: See "[PRACH Restricted Set](#)" on page 239

[:SOURce<hw>]:BB:EUTRa:UL:PUSCh:FHMode <FreqHoppingMode>

Sets the frequency hopping mode for PUSCH.

Parameters:

<FreqHoppingMode> INTRa | INTer
 *RST: INTRa

Example:

BB:EUTR:UL:PUSC:FHM INT
 Selects inter-subframe hopping mode

Manual operation: See "[Frequency Hopping Mode](#)" on page 239

[:SOURCE<hw>]:BB:EUTRa:UL:PUSCh:FHOFFset <FHoppOffset>

Sets the PUSCH Hopping Offset N_{RB}^{HO} .

The PUSCH Hopping Offset determines the first physical resource block and the maximum number of physical resource blocks available for PUSCH transmission if PUSCH frequency hopping is used.

Parameters:

<FHoppOffset> integer
 Range: dynamic to dynamic
 *RST: 0

Example:

BB:EUTR:UL:PUSC:FHOF 2
 Set the PUSCH hopping offset

Manual operation: See "[PUSCH Hopping Offset](#)" on page 240

[:SOURCE<hw>]:BB:EUTRa:UL:PUSCh:NOSM <SubBandCount>

Sets the number of sub-bands (Nsb) into that the total range of physical resource blocks available for PUSCH transmission is divided. The frequency hopping is performed at sub-band level.

Parameters:

<SubBandCount> integer
 Range: 1 to 110
 *RST: 4

Example:

BB:EUTR:UL:PUSC:NOSM 3
 Sets the number of sub-bands

Manual operation: See "[Number of Sub-bands](#)" on page 240

[:SOURCE<hw>]:BB:EUTRa:UL:PUCCh:NORB <RbCount>

Sets the PUCCH region in terms of reserved resource blocks, at the edges of the channel bandwidth.

Parameters:

<RbCount> integer
 Range: 0 to 110
 *RST: 4

Example: `BB:EUTR:UL:PUCCH:NORB 3`
Reserves 3 RBs for PUCCH

Manual operation: See ["Number of RBs used for PUCCH"](#) on page 241

[:SOURCE<hw>]:BB:EUTRa:UL:PUCCh:DESHift <DeltaShift>

Sets the delta shift parameter.

Parameters:

<DeltaShift> integer
Range: 1 to 3
*RST: 2

Example: `BB:EUTR:PUCCH:DESH 3`
Sets the delta shift parameter

Manual operation: See ["Delta Shift"](#) on page 241

[:SOURCE<hw>]:BB:EUTRa:UL:PUCCh:N1CS <N1Cs>

Sets the number of cyclic shifts used for PUCCH format 1/1a/1b in a resource block used for a combination of the formats 1/1a/1b and 2/2a/2b.

Parameters:

<N1Cs> integer
Range: 0 to dynamic
*RST: 6

Example: `BB:EUTR:UL:PUCCH:N1CS 5`
5 cyclic shifts are used for PUCCH format 1/1a/1b in an RB used for a combination of the PUCCH formats 1/1a/1b and 2/2a/2b

Manual operation: See ["N\(1\)_cs"](#) on page 242

[:SOURCE<hw>]:BB:EUTRa:UL:PUCCh:N2RB <N2Rb>

Sets bandwidth in terms of resource blocks that are reserved for PUCCH formats 2/2a/2b transmission in each subframe.

Parameters:

<N2Rb> integer
Range: 0 to dynamic
*RST: 1

Example: `BB:EUTR:UL:PUCCH:N2RB 3`
Reserves 3 RB for PUCCH formats 2/2a/2b

Manual operation: See ["N\(2\)_RB"](#) on page 242

[:SOURce<hw>]:BB:EUTRa:UL:PUCCh:N1NMax?

Queries the range of the possible PUCCH format 1/1a/1b transmissions from different users in one subframe and for normal CP.

Return values:

<N1NormCP> integer
 Range: 0 to 110
 *RST: 44

Example:

BB:EUTR:UL:PUCCh:N1NM?

Queries the range of the possible PUCCH formats 1/1a/1b transmissions.

Response: 24

Usage: Query only

Manual operation: See "[Range n\(1\)_PUCCH \(Normal/Extended CP\)](#)" on page 242

[:SOURce<hw>]:BB:EUTRa:UL:PUCCh:N1EMax?

Queries the range of the possible PUCCH format 1/1a/1b transmissions from different users in one subframe and for extended CP.

Return values:

<N1emax> integer
 Range: 0 to 110
 *RST: 29

Example:

BB:EUTR:UL:PUCCh:N1EM?

Queries the range of the possible PUCCH formats 1/1a/1b transmissions.

Response: 10

Usage: Query only

Manual operation: See "[Range n\(1\)_PUCCH \(Normal/Extended CP\)](#)" on page 242

[:SOURce<hw>]:BB:EUTRa:UL:PUCCh:N2Max?

Queries the range of possible number of PUCCH format 2/2a/2b transmissions from different users in one subframe.

Return values:

<N2Max> integer
 Range: 0 to 110
 *RST: 15

Example:

BB:EUTR:UL:PUCCh:N2M?

Queries the range of the possible PUCCH formats 2/2a/2b transmissions.

Response: 16

Usage: Query only

Manual operation: See "Range n(2)_PUCCH" on page 242

[:SOURCE<hw>]:BB:EUTRa:UL:PUCCh:N5Max?
[:SOURCE<hw>]:BB:EUTRa:UL:PUCCh:N4Max?
[:SOURCE<hw>]:BB:EUTRa:UL:PUCCh:N3Max?

Queries the range of possible number of PUCCH format x transmissions from different users in one subframe.

Return values:

<N3Max> integer
 Range: 0 to 549
 *RST: 19

Usage: Query only

Options: N4Max|N5Max require R&S SMM-K119

Manual operation: See "Range n(3)_PUCCH" on page 242

10.10 DL frame configuration

[:SOURCE<hw>]:BB:EUTRa:DL:BUR	604
[:SOURCE<hw>]:BB:EUTRa:DL:CONSubframes	605
[:SOURCE<hw>]:BB:EUTRa:DL:RSTFrame	605
[:SOURCE<hw>]:BB:EUTRa:DL[:SUBF<st0>]:CYCPrefix	605
[:SOURCE<hw>]:BB:EUTRa:DL[:SUBF<st0>]:ALCount	606
[:SOURCE<hw>]:BB:EUTRa:DL[:SUBF<st0>]:ALLoc<ch0>:CODWords	606
[:SOURCE<hw>]:BB:EUTRa:DL[:SUBF<st0>]:ALLoc<ch0>[:CW<user>]:MODulation	606
[:SOURCE<hw>]:BB:EUTRa:DL[:SUBF<st0>]:ALLoc<ch0>[:CW<user>]:GAP	607
[:SOURCE<hw>]:BB:EUTRa:DL[:SUBF<st0>]:ALLoc<ch0>[:CW<user>]:RBCount	607
[:SOURCE<hw>]:BB:EUTRa:DL[:SUBF<st0>]:ALLoc<ch0>[:CW<user>]:SYMCount	608
[:SOURCE<hw>]:BB:EUTRa:DL[:SUBF<st0>]:ALLoc<ch0>[:CW<user>]:RBOffset	608
[:SOURCE<hw>]:BB:EUTRa:DL[:SUBF<st0>]:ALLoc<ch0>[:CW<user>]:SYMoffset	608
[:SOURCE<hw>]:BB:EUTRa:DL[:SUBF<st0>]:ALLoc<ch0>[:CW<user>]:AOC	609
[:SOURCE<hw>]:BB:EUTRa:DL[:SUBF<st0>]:ALLoc<ch0>[:CW<user>]:PHYSbits?	609
[:SOURCE<hw>]:BB:EUTRa:DL[:SUBF<st0>]:ALLoc<ch0>[:CW<user>]:DATA	609
[:SOURCE<hw>]:BB:EUTRa:DL[:SUBF<st0>]:ALLoc<ch0>[:CW<user>]:PATTern	610
[:SOURCE<hw>]:BB:EUTRa:DL[:SUBF<st0>]:ALLoc<ch0>[:CW<user>]:DSElect	610
[:SOURCE<hw>]:BB:EUTRa:DL[:SUBF<st0>]:ALLoc<ch0>[:CW<user>]:POWER	611
[:SOURCE<hw>]:BB:EUTRa:DL[:SUBF<st0>]:ALLoc<ch0>[:CW<user>]:CONTtype?	611
[:SOURCE<hw>]:BB:EUTRa:DL[:SUBF<st0>]:ALLoc<ch0>[:CW<user>]:STATe	612
[:SOURCE<hw>]:BB:EUTRa:DL[:SUBF<st0>]:ALLoc<ch0>[:CW<user>]:CONFLICT	612
[:SOURCE<hw>]:BB:EUTRa:DL[:SUBF<st0>]:USER<ch>:PHYSbits?	612

[:SOURCE<hw>]:BB:EUTRa:DL:BUR <Bur>

Selects either to fill unscheduled resource elements and subframes with dummy data or DTX.

In "Mode > eMTC/NB-LoT", unused resource elements are filled in with DTX.

Parameters:

<Bur> DUData | DTX
*RST: DUData

Example:

SOURce1:BB:EUTRa:DL:BUR DUData

The unscheduled resource elements are filled with dummy data.

Manual operation: See "[Behavior In Unscheduled REs \(OCNG\)](#)" on page 128

[:SOURce<hw>]:BB:EUTRa:DL:CONSubframes <ConSubFrames>

Sets the number of configurable subframes.

Parameters:

<ConSubFrames> integer
Range: 1 to 40
*RST: 10

Example:

BB:EUTR:DL:CONS 10

Ten subframes are configurable in downlink.

Manual operation: See "[No Of Configurable \(DL\) Subframes](#)" on page 128

[:SOURce<hw>]:BB:EUTRa:DL:RSTFrame

Resets all subframe settings of the selected link direction to the default values.

Example:

BB:EUTR:DL:RSTF

Resets the downlink subframe parameters of path A to the default settings.

Manual operation: See "[Reset All Subframes](#)" on page 128

[:SOURce<hw>]:BB:EUTRa:DL[:SUBF<st0>]:CYCPrefix <CycPrefix>

(enabled for BB:EUTR:DL:CPC USER only)

Sets the cyclic prefix for the according subframe.

Parameters:

<CycPrefix> NORMal | EXTended
*RST: NORMal

Example:

BB:EUTR:DL:CPC USER

The cyclic prefix has to be adjusted on subframe basis.

BB:EUTR:DL:SUBF6:CYCP NORM

A normal prefix is used in subframe 6 in downlink.

Manual operation: See "[Cyclic Prefix](#)" on page 163

[:SOURCE<hw>]:BB:EUTRa:DL[:SUBF<st0>]:ALCount <AllocCount>

Sets the number of scheduled allocations in the selected subframe. The maximum number of allocations that can be scheduled depends on the number of the selected resource blocks.

Parameters:

<AllocCount> integer
 Range: 0 to dynamic
 *RST: 2 (SUBF0, SUBF10, SUBF20, SUBF30); 1 (all other subframes)

Example: BB:EUTR:DL:SUBF4:ALC 5
 Five scheduled allocations are assigned to subframe four.

Manual operation: See ["No. Of Used Allocations"](#) on page 164

[:SOURCE<hw>]:BB:EUTRa:DL[:SUBF<st0>]:ALLoc<ch0>:CODWords <CodeWords>

Sets the number of codewords for an allocation.

Two codewords are available for global MIMO configuration with two or more antennas.

Parameters:

<CodeWords> 1 | 2
 Range: 1 to 2
 *RST: 1

Manual operation: See ["Codeword"](#) on page 165
 See ["Codeword"](#) on page 205

[:SOURCE<hw>]:BB:EUTRa:DL[:SUBF<st0>]:ALLoc<ch0>[:CW<user>]:MODulation <Modulation>

Sets the modulation scheme for the allocation.

Parameters:

<Modulation> QPSK | QAM16 | QAM64 | QAM256 | QAM1024
 *RST: QPSK

Example: BB:EUTR:DL:SUBF4:ALL5:CW2:MOD QPSK
 Selects QPSK as modulation scheme for the allocation.

Example: SOUR:BB:EUTR:DL:SUBF1:ALL5:CW2:MOD QPSK
 SOUR:BB:EUTR:DL:SUBF1:ALL5:CW:DATA USER3
 SOUR:BB:EUTR:DL:SUBF1:ALL7:CW:DATA USER3
 SOUR:BB:EUTR:DL:SUBF1:ALL5:CW2:MOD?
 Response: QPSK

Options: QAM256 requires option R&S SMM-K113
 QAM1024 requires R&S SMM-K119

Manual operation: See "[Modulation](#)" on page 165

[:SOURCE<hw>]:BB:EUTRa:DL[:SUBF<st0>]:ALLOc<ch0>[:CW<user>]:GAP
 <VrbGap>

Enables/disables the unitization of distributed Virtual Resource Blocks (VBR) and determines whether the first or the second VRB gap is applied.

Parameters:

<VrbGap> integer

0
 A **localized distribution** is applied, i.e. the PDSCH mapping is performed on a direct VRB-to-PRB mapping.

1
 Enables a **distributed** resource block allocation. The first VRB gap is used.

2
 Enabled for "Channel Bandwidths" greater than 50 RBs. The mapping is based on the second (smaller) VRB gap.

Range: 0 to 2
 *RST: 0

Example: SOUR:BB:EUTR:DL:BW BW10_00
 SOUR:BB:EUTR:SUBF0:ALL2:GAP2

Manual operation: See "[VRB Gap](#)" on page 166

[:SOURCE<hw>]:BB:EUTRa:DL[:SUBF<st0>]:ALLOc<ch0>[:CW<user>]:RBCCount
 <ResBlockCount>

Sets the size of the selected allocation in resource blocks (per slot).

For allocations with two codewords, the number of resource blocks for the second codeword is automatically set to the number of resource blocks set for the first one.

Parameters:

<ResBlockCount> integer

AUTO
 Indicates automatically calculated value depending on other settings

Range: 1 to 110
 *RST: 1

Example: BB:EUTR:DL:SUBF4:ALL5:CW:RBC 3

Manual operation: See "[No. RB \(Resource Blocks\)](#)" on page 167

[:SOURce<hw>]:BB:EUTRa:DL[:SUBF<st0>]:ALLoc<ch0>[:CW<user>]:SYMCCount <SymCount>

Sets the size of the selected allocation in OFDM symbols.

For content type PBCH, PDCCH and PDSCH, this value is set automatically.

For allocations with two codewords, the number of symbols for the second codeword is automatically set to number of symbols set for the first one.

Parameters:

<SymCount> integer
 Range: 1 to 14
 *RST: 6 (PBCH); 12 (PDSCH)

Example:

For FDD mode and content type PDSCH, this value is set automatically in a way that the allocation always fills the complete subframe with consideration of the symbol offset.

```
SOUR:BB:EUTR:DL:SUBF1:CYCP NORM
SOUR:BB:EUTR:DL:SUBF2:ALL2:CW2:SYM 2
SOUR:BB:EUTR:DL:SUBF1:ALL2:CW2:SYMC 12
```

Manual operation: See "[No. Sym.](#)" on page 167

[:SOURce<hw>]:BB:EUTRa:DL[:SUBF<st0>]:ALLoc<ch0>[:CW<user>]:RBOffset <ResBlockOffset>

Queries the start resource block of the selected allocation.

Parameters:

<ResBlockOffset> integer
AUTO
 Indicates automatically calculated value depending on other settings
 Range: 0 to dynamic
 *RST: dynamic

Example:

```
BB:EUTR:DL:SUBF4:ALL5:CW:RBOF?
```

Manual operation: See "[Offset RB](#)" on page 168

[:SOURce<hw>]:BB:EUTRa:DL[:SUBF<st0>]:ALLoc<ch0>[:CW<user>]:SYMOffset <SymOffset>

Sets the start OFDM symbol of the selected allocation.

Parameters:

<SymOffset> integer
 Range: 0 to 13
 *RST: 2

Example: BB:EUTR:DL:SUBF4:ALL5: CW:SYM 5
OFDM symbol five is the start OFDM symbol for allocation five in subframe four.

Manual operation: See ["Offset Sym."](#) on page 168

[:SOURCE<hw>]:BB:EUTRa:DL[:SUBF<st0>]:ALLOc<ch0>[:CW<user>]:AOC<Aoc>

Sets whether automatic offset calculation is used or not.

Parameters:

<Aoc> 1 | ON | 0 | OFF
*RST: ON

Example: BB:EUTR:DL:SUBF4:ALL5: CW:AOC ON
Activates the automatic offset calculation for the selected allocation.

Manual operation: See ["Auto"](#) on page 169

[:SOURCE<hw>]:BB:EUTRa:DL[:SUBF<st0>]:ALLOc<ch0>[:CW<user>]:PHYSbits?

Queries the number of physical bits for the selected allocation. The value is set automatically according to the current allocation settings.

Return values:

<PhysicalBits> integer
AUTO
Indicates automatically calculated value depending on other settings
Range: 0 to 105600
*RST: 0

Example: BB:EUTR:DL:SUBF4:ALL5: CW:PHYS?
Queries the number of physical bits for allocation five in subframe four.

Usage: Query only

Manual operation: See ["Phys. Bits"](#) on page 169
See ["Number of Physical Bits \(DL\)"](#) on page 211

[:SOURCE<hw>]:BB:EUTRa:DL[:SUBF<st0>]:ALLOc<ch0>[:CW<user>]:DATA<Data>

Sets the data source for the selected allocation.

For allocations with two codewords, the data source for the second codeword is automatically set to the data source set for the first one.

Parameters:

<Data> USER1 | USER2 | USER3 | USER4 | PN9 | PN11 | PN15 |
PN16 | PN20 | PN21 | PN23 | PATtern | DLSt | ZERO | ONE |
MIB | MCCH | MTCH

MIB

(Result parameter)

Indicates that the PBCH transmits real MIB data.

(See also [:SOURce<hw>] :BB:EUTRa:DL:PBCH:MIB
on page 648)

MCCH|MTCH

(Result parameter)

Indicates allocations in the MBSFN subframes, if MBSFN is used.

(See also [:SOURce<hw>] :BB:EUTRa:DL:MBSFN:MODE
on page 620)

*RST: dynamic

Example:

BB:EUTR:DL:SUBF4:ALL5:CW:DATA PN9
PN9 is the data source for the selected allocation.

Manual operation: See "Data Source" on page 169

[:SOURce<hw>] :BB:EUTRa:DL [:SUBF<st0>] :ALLoc<ch0> [:CW<user>] :PATtern
<Pattern>, <BitCount>

Sets a bit pattern as data source.

Parameters:

<Pattern> numeric
*RST: #H0

<BitCount> integer
Range: 1 to 64
*RST: 1

Example:

BB:EUTR:DL:SUBF4:ALL5:CW:DATA PATT
BB:EUTR:DL:SUBF4:ALL5:CW:PATT #H3F,8

Manual operation: See "Data Source" on page 169

[:SOURce<hw>] :BB:EUTRa:DL [:SUBF<st0>] :ALLoc<ch0> [:CW<user>] :DSElect
<DSelect>

Selects an existing data list file from the default directory or from the specific directory.

Parameters:

<DSelect> string
Filename incl. file extension or complete file path

Example: BB:EUTR:DL:SUBF2:ALL5:CW:DATA DLIST
 BB:EUTR:DL:SUBF2:ALL5:CW:DSElect
 "/var/user/eutra_list1"

Manual operation: See "Data Source" on page 169

**[:SOURce<hw>]:BB:EUTRa:DL[:SUBF<st0>]:ALLoc<ch0>[:CW<user>]:POWER
 <Power>**

Sets the power P_{PDSCH} respectively P_{PBCH} for the selected allocation. The power of the PDCCH allocation P_{PDCCH} is read-only. The value is set with the command [:

SOURce<hw>]:BB:EUTRa:DL[:SUBF<st0>]:ENCC:PDCCCh:POWER.

For allocations with two codewords, the power for the second codeword is automatically set to the power set for first one.

Parameters:

<Power> float
 Range: -80 to 10
 Increment: 0.001
 *RST: 0

Example: P_{PDSCH} , P_{PBCH}
 SOUR:BB:EUTR:DL:SUBF1:ALL2:POW 10.00

Example: P_{PDCCH}
 SOUR:BB:EUTR:DL:SUBF1:ENCC:PDCC:POW 2.00
 SOUR:BB:EUTR:DL:SUBF1:ALL1:POW?
 Response: 2

Manual operation: See "Rho A" on page 170

**[:SOURce<hw>]:BB:EUTRa:DL[:SUBF<st0>]:ALLoc<ch0>[:CW<user>]:
 CONType?**

Queries the type for the selected allocation.

PBCH can be configured in subframe 0 only.

Return values:

<ConType> PDSch | PBCH | PDCCCh | PMCH
 *RST: PDSCh

Example: BB:EUTR:DL:SUBF4:ALL5:CW:CONT?
 Response: PDSC

Usage: Query only

Options: PMCH requires R&S SMM-K84

Manual operation: See "Content Type" on page 170

[:SOURce<hw>]:BB:EUTRa:DL[:SUBF<st0>]:ALLoc<ch0>[:CW<user>]:STATe
 <State>

Sets the allocation state to active or inactive.

Parameters:

<State> 1 | ON | 0 | OFF
 *RST: OFF

Example: BB:EUTR:DL:SUBF4:ALL5:CW:STAT OFF
 Deactivates the selected allocation.

Manual operation: See "State" on page 170

[:SOURce<hw>]:BB:EUTRa:DL[:SUBF<st0>]:ALLoc<ch0>[:CW<user>]:CONFLICT
 <Conflict>

Indicates a conflict between two allocations.

Parameters:

<Conflict> 1 | ON | 0 | OFF
 *RST: OFF

Example: BB:EUTR:DL:SUBF4:ALL5:CW2:CONF?
 Queries for the selected allocation whether there is a conflict with another allocation.

Manual operation: See "Conflict" on page 171

[:SOURce<hw>]:BB:EUTRa:DL[:SUBF<st0>]:USER<ch>:PHYSbits?

Queries the size of the selected allocation in bits and considering the subcarriers that are used for other signals or channels with higher priority.

If a User 1...4 is selected for the "Data Source" in the allocation table for the corresponding allocation, the value of the parameter "Number of Physical Bits" is the sum of the "Physical Bits" of all single allocations that belong to the same user in the selected subframe.

Return values:

<PhysicalBits> integer
 Range: 0 to 100000
 *RST: 0

Example: BB:EUTR:DL:SUBF1:USER3:PHYS?
 Queries the number of physical bits

Usage: Query only

Manual operation: See "Number of Physical Bits (DL)" on page 211

10.11 DL MBFSN

Option: R&S SMM-K84.

Example: Enabling and configuring MBSFN transmission

The following is a simple example of how to configure an MBSFN signal.

```

SOURCEl:BB:EUTRa:DUPLexing FDD
SOURCEl:BB:EUTRa:LINK DOWN
SOURCEl:BB:EUTRa:SLenGth 512
SOURCEl:BB:EUTRa:DL:BW BW1_40
SOURCEl:BB:EUTRa:DL:MBSFn:MODE MIX
SOURCEl:BB:EUTRa:DL:MBSFn:UEC C5
SOURCEl:BB:EUTRa:DL:MBSFn:RHOA 0

SOURCEl:BB:EUTRa:DL:MBSFn:SC:APER AP8
SOURCEl:BB:EUTRa:DL:MBSFn:SC:AOFFset 2
SOURCEl:BB:EUTRa:DL:MBSFn:SC:AMODe F4
SOURCEl:BB:EUTRa:DL:MBSFn:SC:AVAL 11184810

SOURCEl:BB:EUTRa:DL:MBSFn:AI:MCCH:STATe 1
SOURCEl:BB:EUTRa:DL:MBSFn:AI:ID 0
SOURCEl:BB:EUTRa:DL:MBSFn:AI:NMRL 2
SOURCEl:BB:EUTRa:DL:MBSFn:AI:MCCH:RPER RP128
SOURCEl:BB:EUTRa:DL:MBSFn:AI:MCCH:MPER MP512
SOURCEl:BB:EUTRa:DL:MBSFn:AI:MCCH:NRC NRC2
SOURCEl:BB:EUTRa:DL:MBSFn:AI:MCCH:NSI 4
SOURCEl:BB:EUTRa:DL:MBSFn:AI:MCCH:OFFS 0
SOURCEl:BB:EUTRa:DL:MBSFn:AI:MCCH:MCS MCS2
SOURCEl:BB:EUTRa:DL:MBSFn:AI:MCCH:DATA PN9
SOURCEl:BB:EUTRa:DL:MBSFn:AI:MCCH:NPATtern #H0,1
SOURCEl:BB:EUTRa:DL:MBSFn:AI:MCCH:NOFFset 0
SOURCEl:BB:EUTRa:DL:MBSFn:AI:NIND?
// Response: 2
SOURCEl:BB:EUTRa:DL:MBSFn:AI:MCCH:AVAL?
// Response: 11184810
SOURCEl:BB:EUTRa:DL:MBSFn:AI:MCCH:MODulation?
Response: QPSK
SOURCEl:BB:EUTRa:DL:MBSFn:AI:MCCH:TBSize?
// Response: 2216

SOURCEl:BB:EUTRa:DL:MBSFn:MTCH:CSAP AP64
SOURCEl:BB:EUTRa:DL:MBSFn:MTCH:NPMChs 3
SOURCEl:BB:EUTRa:DL:MBSFn:PMCH0:SASStart 0
SOURCEl:BB:EUTRa:DL:MBSFn:PMCH1:SPERiod SPRF8
SOURCEl:BB:EUTRa:DL:MBSFn:PMCH0:MCSTwo 0
SOURCEl:BB:EUTRa:DL:MBSFn:PMCH0:MCS 5
SOURCEl:BB:EUTRa:DL:MBSFn:PMCH0:MOD?
// QPSK

```

```

SOURCE1:BB:EUTRa:DL:MBSFn:PMCH0:MCSTwo 1
SOURCE1:BB:EUTRa:DL:MBSFn:PMCH0:MOD?
// QAM16
SOURCE1:BB:EUTRa:DL:MBSFn:PMCH0:DATA PN9
SOURCE1:BB:EUTRa:DL:MBSFn:PMCH0:STATe 1
SOURCE1:BB:EUTRa:DL:MBSFn:PMCH1:SPERiod SPRF8
SOURCE1:BB:EUTRa:DL:MBSFn:PMCH2:SPERiod SPRF8

SOURCE1:BB:EUTRa:STATe 1

[:SOURCE<hw>]:BB:EUTRa:DL:MBSFn:AI:ID..... 615
[:SOURCE<hw>]:BB:EUTRa:DL:MBSFn:AI:MCCH:AVAL?..... 615
[:SOURCE<hw>]:BB:EUTRa:DL:MBSFn:AI:MCCH:DATA..... 615
[:SOURCE<hw>]:BB:EUTRa:DL:MBSFn:AI:MCCH:DLiSt..... 615
[:SOURCE<hw>]:BB:EUTRa:DL:MBSFn:AI:MCCH:MCS..... 616
[:SOURCE<hw>]:BB:EUTRa:DL:MBSFn:AI:MCCH:MODulation?..... 616
[:SOURCE<hw>]:BB:EUTRa:DL:MBSFn:AI:MCCH:MPER..... 616
[:SOURCE<hw>]:BB:EUTRa:DL:MBSFn:AI:MCCH:NOFFset..... 616
[:SOURCE<hw>]:BB:EUTRa:DL:MBSFn:AI:MCCH:NPATtern..... 617
[:SOURCE<hw>]:BB:EUTRa:DL:MBSFn:AI:MCCH:NRC..... 617
[:SOURCE<hw>]:BB:EUTRa:DL:MBSFn:AI:MCCH:NSI..... 617
[:SOURCE<hw>]:BB:EUTRa:DL:MBSFn:AI:MCCH:OFFS..... 618
[:SOURCE<hw>]:BB:EUTRa:DL:MBSFn:AI:MCCH:PATtern..... 618
[:SOURCE<hw>]:BB:EUTRa:DL:MBSFn:AI:MCCH:RPER..... 618
[:SOURCE<hw>]:BB:EUTRa:DL:MBSFn:AI:MCCH:STATe..... 618
[:SOURCE<hw>]:BB:EUTRa:DL:MBSFn:AI:MCCH:TBSiZe?..... 619
[:SOURCE<hw>]:BB:EUTRa:DL:MBSFn:AI:NIND..... 619
[:SOURCE<hw>]:BB:EUTRa:DL:MBSFn:AI:NMRL..... 619
[:SOURCE<hw>]:BB:EUTRa:DL:MBSFn:MODE..... 620
[:SOURCE<hw>]:BB:EUTRa:DL:MBSFn:MTCH:CSAP..... 620
[:SOURCE<hw>]:BB:EUTRa:DL:MBSFn:MTCH:NPMChs..... 620
[:SOURCE<hw>]:BB:EUTRa:DL:MBSFn:PMCH<ch0>:STATe..... 620
[:SOURCE<hw>]:BB:EUTRa:DL:MBSFn:PMCH<ch0>:DATA..... 621
[:SOURCE<hw>]:BB:EUTRa:DL:MBSFn:PMCH<ch0>:DLiSt..... 621
[:SOURCE<hw>]:BB:EUTRa:DL:MBSFn:PMCH<ch0>:PATtern..... 621
[:SOURCE<hw>]:BB:EUTRa:DL:MBSFn:PMCH<ch0>:MCSTwo..... 621
[:SOURCE<hw>]:BB:EUTRa:DL:MBSFn:PMCH<ch0>:MCS..... 622
[:SOURCE<hw>]:BB:EUTRa:DL:MBSFn:PMCH<ch0>:MOD?..... 622
[:SOURCE<hw>]:BB:EUTRa:DL:MBSFn:PMCH<ch0>:SPERiod..... 622
[:SOURCE<hw>]:BB:EUTRa:DL:MBSFn:PMCH<ch0>:SASart..... 623
[:SOURCE<hw>]:BB:EUTRa:DL:MBSFn:PMCH<ch0>:SAENd..... 623
[:SOURCE<hw>]:BB:EUTRa:DL:MBSFn:RHOA..... 623
[:SOURCE<hw>]:BB:EUTRa:DL:MBSFn:SC:AMODE..... 623
[:SOURCE<hw>]:BB:EUTRa:DL:MBSFn:SC:AOFFset..... 623
[:SOURCE<hw>]:BB:EUTRa:DL:MBSFn:SC:APER..... 624
[:SOURCE<hw>]:BB:EUTRa:DL:MBSFn:SC:AVAL..... 624
[:SOURCE<hw>]:BB:EUTRa:DL:MBSFn:UEC..... 624

```

[[:SOURce<hw>]:BB:EUTRa:DL:MBSFn:AI:ID <AreaID>

Defines the MBSFN area ID, parameter N_{id}^{MBSFN} .

Parameters:

<AreaID> integer
 Range: 0 to 255
 *RST: 0

Example: See [Example"Enabling and configuring MBSFN transmission"](#) on page 613

Manual operation: See ["Area ID \(N_ID_MBSFN\)"](#) on page 87

[[:SOURce<hw>]:BB:EUTRa:DL:MBSFn:AI:MCCH:AVAl? <AllocationValue>

Indicates the subframes of the radio frames indicated by the "MCCH repetition period" and the "MCCH offset", that may carry MCCH.

Parameters:

<AllocationValue> integer

Example: See [Example"Enabling and configuring MBSFN transmission"](#) on page 613

Usage: Query only

Manual operation: See ["Allocation Value \(HEX\)"](#) on page 88

[[:SOURce<hw>]:BB:EUTRa:DL:MBSFn:AI:MCCH:DATA <DataSource>

Sets the data source used for the MCCH.

Parameters:

<DataSource> PN9 | PN11 | PN15 | PN16 | PN20 | PN21 | PN23 | PATTeRn | DLISt | ZERO | ONE
 *RST: PN9

Example: See [Example"Enabling and configuring MBSFN transmission"](#) on page 613

Manual operation: See ["MCCH Data Source"](#) on page 89

[[:SOURce<hw>]:BB:EUTRa:DL:MBSFn:AI:MCCH:DLISt <DataList>

Sets the data list used as data source for MCCH.

Parameters:

<DataList> string

Example: See [Example"Enabling and configuring MBSFN transmission"](#) on page 613

Manual operation: See ["MCCH Data Source"](#) on page 89

[:SOURCE<hw>]:BB:EUTRa:DL:MBSFn:AI:MCCH:MCS <MCS>

Defines the Modulation and Coding Scheme (MCS) applicable for the subframes indicated by the "MCCH Allocation value" and for the first subframe of each MCH scheduling period (which may contain the MCH scheduling information provided by MAC).

Parameters:

<MCS> MCS19 | MCS13 | MCS7 | MCS2
 *RST: MCS2

Example: See [Example"Enabling and configuring MBSFN transmission"](#) on page 613

Manual operation: See ["MCCH MCS"](#) on page 89

[:SOURCE<hw>]:BB:EUTRa:DL:MBSFn:AI:MCCH:MODulation? <Modulation>

Queries the values as set with the command [\[:SOURCE<hw>\]:BB:EUTRa:DL:MBSFn:AI:MCCH:MCS](#).

Parameters:

<Modulation> QPSK | QAM16 | QAM64
 *RST: QPSK

Example: See [Example"Enabling and configuring MBSFN transmission"](#) on page 613

Usage: Query only

Manual operation: See ["MCCH Modulation"](#) on page 89

[:SOURCE<hw>]:BB:EUTRa:DL:MBSFn:AI:MCCH:MPER <ModifPeriod>

Sets the MCCH Modification Period.

Parameters:

<ModifPeriod> MP512 | MP1024
 *RST: MP512

Example: See [Example"Enabling and configuring MBSFN transmission"](#) on page 613

Manual operation: See ["MCCH Modification Period"](#) on page 88

[:SOURCE<hw>]:BB:EUTRa:DL:MBSFn:AI:MCCH:NOFFset <NotifOffset>

Defines, together with the [\[:SOURCE<hw>\]:BB:EUTRa:DL:MBSFn:AI:MCCH:NRC](#), the radio frames in which the MCCH information change notification is scheduled.

Parameters:

<NotifOffset> integer
 Range: 0 to 10
 *RST: 0

Example: See [Example"Enabling and configuring MBSFN transmission"](#) on page 613

Manual operation: See ["Notification Offset"](#) on page 90

[:SOURCE<hw>]:BB:EUTRa:DL:MBSFn:AI:MCCH:NPATtern <NotifPattern>, <BitCount>

Sets the pattern for the notification bits sent on PDCCH DCI format 1c.

Parameters:

<NotifPattern> numeric
 *RST: #H0

<BitCount> integer
 Range: 1 to 64
 *RST: 1

Example: See [Example"Enabling and configuring MBSFN transmission"](#) on page 613.

Manual operation: See ["Notification Pattern"](#) on page 90

[:SOURCE<hw>]:BB:EUTRa:DL:MBSFn:AI:MCCH:NRC <NotifRepetCoeff>

Selects the current change notification repetition period common for all MCCHs that are configured.

Parameters:

<NotifRepetCoeff> NRC2 | NRC4
 *RST: NRC2

Example: See [Example"Enabling and configuring MBSFN transmission"](#) on page 613

Manual operation: See ["Notification Repetition Coefficient"](#) on page 89

[:SOURCE<hw>]:BB:EUTRa:DL:MBSFn:AI:MCCH:NSI <Index>

Defines the subframe used to transmit MCCH change notifications on PDCCH.

Parameters:

<Index> integer
 In FDD: values 1 to 6 correspond with subframes #1, #2, #3, #6, #7 and #8
 In TDD: values 1 to 5 correspond with subframe #3, #4, #7, #8 and #9
 Range: 1 to dynamic
 *RST: 1

Example: See [Example"Enabling and configuring MBSFN transmission"](#) on page 613

Manual operation: See ["Notification Subframe Index"](#) on page 90

[:SOURce<hw>]:BB:EUTRa:DL:MBSFn:AI:MCCH:OFFS <McchOffset>

Indicates, together with the [\[:SOURce<hw>\] :BB:EUTRa:DL:MBSFn:AI:MCCH:RPER](#), the radio frames in which MCCH is scheduled.

Parameters:

<McchOffset> integer
 Range: 0 to 10
 *RST: 0

Example: See [Example"Enabling and configuring MBSFN transmission"](#) on page 613

Manual operation: See ["MCCH Offset"](#) on page 88

[:SOURce<hw>]:BB:EUTRa:DL:MBSFn:AI:MCCH:PATtern <Pattern>, <BitCount>

Sets the pattern used as data source for the MCCH.

Parameters:

<Pattern> numeric
 *RST: #H0
 <BitCount> integer
 Range: 1 to 64
 *RST: 1

Example: See [Example"Enabling and configuring MBSFN transmission"](#) on page 613.

Manual operation: See ["MCCH Data Source"](#) on page 89

[:SOURce<hw>]:BB:EUTRa:DL:MBSFn:AI:MCCH:RPER <RepetPeriod>

Defines the interval between transmissions of MCCH information in radio frames.

Parameters:

<RepetPeriod> RP64 | RP32 | RP128 | RP256
 *RST: RP32

Example: See [Example"Enabling and configuring MBSFN transmission"](#) on page 613

Manual operation: See ["MCCH Repetition Period"](#) on page 88

[:SOURce<hw>]:BB:EUTRa:DL:MBSFn:AI:MCCH:STATe <McchState>

Enables/disables the MCCH.

Parameters:

<McchState> 1 | ON | 0 | OFF
 *RST: 1

Example: See [Example"Enabling and configuring MBSFN transmission"](#) on page 613

Manual operation: See ["MCCH State"](#) on page 88

[:SOURCE<hw>]:BB:EUTRa:DL:MBSFn:AI:MCCH:TBSize? <TB_Size>

Queries the values as determined by the "MCCH MCS".

Parameters:

<TB_Size> integer

Example: See [Example"Enabling and configuring MBSFN transmission"](#) on page 613

Usage: Query only

Manual operation: See ["MCCH Transport Block Size"](#) on page 89

[:SOURCE<hw>]:BB:EUTRa:DL:MBSFn:AI:NIND <NotifIndicator>

Defines which PDCCH bit is used to notify the UE about change of the MCCH applicable for this MBSFN area.

Parameters:

<NotifIndicator> integer
 Range: 0 to 7
 *RST: 0

Example: See [Example"Enabling and configuring MBSFN transmission"](#) on page 613

Manual operation: See ["Notification Indicator"](#) on page 88

[:SOURCE<hw>]:BB:EUTRa:DL:MBSFn:AI:NMRL <RegionLength>

Defines how many symbols from the beginning of the subframe constitute the non-MBSFN region.

Parameters:

<RegionLength> integer
 Range: 1 to 2
 *RST: 2

Example: See [Example"Enabling and configuring MBSFN transmission"](#) on page 613

Manual operation: See ["Non-MBSFN Region Length"](#) on page 87

[:SOURce<hw>]:BB:EUTRa:DL:MBSFn:MODE <MbsfnMode>

Enables the MBSFN transmission and selects a mixed MBSFN Mode.

Parameters:

<MbsfnMode> OFF | MIXed
 *RST: OFF

Example: See [Example"Enabling and configuring MBSFN transmission"](#) on page 613

Manual operation: See ["MBSFN Mode"](#) on page 85

[:SOURce<hw>]:BB:EUTRa:DL:MBSFn:MTCH:CSAP <AllocPeriod>

Defines the period during which resources corresponding with field *commonSF-Alloc* are divided between the (P)MCH that are configured for this MBSFN area.

Parameters:

<AllocPeriod> AP4 | AP8 | AP16 | AP32 | AP64 | AP128 | AP256
 *RST: AP4

Example: See [Example"Enabling and configuring MBSFN transmission"](#) on page 613

Manual operation: See ["Common Subframe Allocation Period"](#) on page 90

[:SOURce<hw>]:BB:EUTRa:DL:MBSFn:MTCH:NPMCHs <NumOfPMCHs>

Defines the number of PMCHs in this MBSFN area.

Parameters:

<NumOfPMCHs> int
 Range: 1 to 15
 Increment: 1
 *RST: 1

Example: See [Example"Enabling and configuring MBSFN transmission"](#) on page 613

Manual operation: See ["Number of PMCHs"](#) on page 91

[:SOURce<hw>]:BB:EUTRa:DL:MBSFn:PMCH<ch0>:STATe <PmchState>

Enables/disables the selected PMCH/MTCH.

Parameters:

<PmchState> 1 | ON | 0 | OFF
 *RST: 1

Example: See [Example"Enabling and configuring MBSFN transmission"](#) on page 613

Manual operation: See ["State"](#) on page 92

[[:SOURce<hw>]:BB:EUTRa:DL:MBSFn:PMCH<ch0>:DATA <DataSource>

Sets the data source for the selected PMCH/MTCH.

Parameters:

<DataSource> PN9 | PN11 | PN15 | PN16 | PN20 | PN21 | PN23 | PATTErn |
DLISt | ZERO | ONE
*RST: PN9

Example: See [Example"Enabling and configuring MBSFN transmission"](#) on page 613

Manual operation: See ["Data Source"](#) on page 92

[[:SOURce<hw>]:BB:EUTRa:DL:MBSFn:PMCH<ch0>:DLISt <DataList>

Sets the data list of the data source for the selected PMCH/MTCH.

Parameters:

<DataList> string

Example: See [Example"Enabling and configuring MBSFN transmission"](#) on page 613

Manual operation: See ["Data Source"](#) on page 92

[[:SOURce<hw>]:BB:EUTRa:DL:MBSFn:PMCH<ch0>:PATTErn <Pattern>, <BitCount>

Sets the pattern of the data source for the selected PMCH/MTCH.

Parameters:

<Pattern> numeric
*RST: #H0

<BitCount> integer
Range: 1 to 64
*RST: 1

Example: See [Example"Enabling and configuring MBSFN transmission"](#) on page 613

Manual operation: See ["Data Source"](#) on page 92

[[:SOURce<hw>]:BB:EUTRa:DL:MBSFn:PMCH<ch0>:MCSTwo <PmchMcsTwo>

Defines which of the two tables defined in [TS 36.213](#) is used to specify the used modulation and coding scheme.

Parameters:

<PmchMcsTwo> 1 | ON | 0 | OFF
0
Table 7.1.7.1-1 is used

1
Table 7.1.7.1-1A is used
*RST: 0

Example: See [Example "Enabling and configuring MBSFN transmission"](#) on page 613

Options: R&S SMM-K113

Manual operation: See ["Use Table 2"](#) on page 91

[:SOURce<hw>]:BB:EUTRa:DL:MBSFn:PMCH<ch0>:MCS <MCS>

Sets the modulation and coding scheme (MCS) applicable for the subframes of the (P)MCH.

Parameters:
<MCS> integer
Range: 0 to 28
*RST: 0

Example: See [Example "Enabling and configuring MBSFN transmission"](#) on page 613

Manual operation: See ["MCS"](#) on page 92

[:SOURce<hw>]:BB:EUTRa:DL:MBSFn:PMCH<ch0>:MOD?

Queries the used modulation.

Return values:
<PmchMod> QPSK | QAM16 | QAM64 | QAM256
*RST: QPSK

Example: See [Example "Enabling and configuring MBSFN transmission"](#) on page 613

Usage: Query only

Options: QAM256 requires R&S SMM-K113

Manual operation: See ["Modulation"](#) on page 92

[:SOURce<hw>]:BB:EUTRa:DL:MBSFn:PMCH<ch0>:SPERiod <SchedPeriod>

Defines the MCH scheduling period, i.e. the periodicity used for providing MCH scheduling information at lower layers (MAC) applicable for an MCH.

Parameters:
<SchedPeriod> SPM | SPRF8 | SPRF16 | SPRF32 | SPRF64 | SPRF128 |
SPRF256 | SPRF512 | SPRF1024
*RST: SPM

Example: See [Example"Enabling and configuring MBSFN transmission"](#) on page 613

Manual operation: See ["MCH Scheduling Period"](#) on page 92

[:SOURCE<hw>]:BB:EUTRa:DL:MBSFn:PMCH<ch0>:SASStart <AllocStart>
[:SOURCE<hw>]:BB:EUTRa:DL:MBSFn:PMCH<ch0>:SAEnd <AllocEnd>

Defines the first/last subframe allocated to this (P)MCH within a period identified by field *commonSF-Alloc*.

Parameters:

<AllocEnd> integer
 Range: 0 to 1535
 *RST: 23

Example: See [Example"Enabling and configuring MBSFN transmission"](#) on page 613

Manual operation: See ["SF Alloc Start/SF Alloc End"](#) on page 91

[:SOURCE<hw>]:BB:EUTRa:DL:MBSFn:RHOA <RhoA>

Defines the power of the MBSFN channels relative to the common Reference Signals.

Parameters:

<RhoA> float
 Range: -80 to 10
 Increment: 0.001
 *RST: 0

Example: See [Example"Enabling and configuring MBSFN transmission"](#) on page 613

Manual operation: See ["MBSFN Rho A"](#) on page 85

[:SOURCE<hw>]:BB:EUTRa:DL:MBSFn:SC:AMODE <AllocationMode>

Defines whether MBSFN periodic scheduling is 1 or 4 frames.

Parameters:

<AllocationMode> F1 | F4
 *RST: F1

Example: See [Example"Enabling and configuring MBSFN transmission"](#) on page 613

Manual operation: See ["Subframe Allocation Mode"](#) on page 86

[:SOURCE<hw>]:BB:EUTRa:DL:MBSFn:SC:AOFFSET <Offset>

Sets the Radio Frame Allocation Offset

Parameters:

<Offset> integer
 Range: 0 to 31
 *RST: 0

Example: See [Example"Enabling and configuring MBSFN transmission"](#) on page 613

Manual operation: See ["Radio Frame Allocation Offset"](#) on page 86

[:SOURCE<hw>]:BB:EUTRa:DL:MBSFn:SC:APER <AllocPeriod>

Sets the Radio Frame Allocation Period.

Parameters:

<AllocPeriod> AP1 | AP2 | AP4 | AP8 | AP16 | AP32
 *RST: AP1

Example: See [Example"Enabling and configuring MBSFN transmission"](#) on page 613

Manual operation: See ["Radio Frame Allocation Period"](#) on page 86

[:SOURCE<hw>]:BB:EUTRa:DL:MBSFn:SC:AVAL <AllocationValue>

Defines which MBSFN subframes are allocated.

Parameters:

<AllocationValue> integer
 Range: 0 to #HFFFFFFF
 *RST: #H3F

Example: See [Example"Enabling and configuring MBSFN transmission"](#) on page 613

Manual operation: See ["Allocation value \(HEX\)"](#) on page 86

[:SOURCE<hw>]:BB:EUTRa:DL:MBSFn:UEC <UeCategory>

Defines the UE category as defined in [TS 36.306](#).

Parameters:

<UeCategory> C1 | C2 | C3 | C4 | C5
 *RST: C5

Example: See [Example"Enabling and configuring MBSFN transmission"](#) on page 613

Manual operation: See ["UE Category"](#) on page 85

10.12 DL carrier aggregation

Option: R&S SMM-K55 and R&S SMM-K85

<code>[:SOURCE<hw>]:BB:EUTRa:DL:CA:STATE</code>	625
<code>[:SOURCE<hw>]:BB:EUTRa:DL:CA:CELL<ch0>:BB</code>	625
<code>[:SOURCE<hw>]:BB:EUTRa:DL:CA:CELL<ch0>:BW</code>	625
<code>[:SOURCE<hw>]:BB:EUTRa:DL:CA:CELL<ch0>:CIF</code>	626
<code>[:SOURCE<hw>]:BB:EUTRa:DL:CA:CELL<ch0>:DFReq</code>	626
<code>[:SOURCE<hw>]:BB:EUTRa:DL:CA:CELL<ch0>:ID</code>	626
<code>[:SOURCE<hw>]:BB:EUTRa:DL:CA:CELL<ch0>:DUPLexing</code>	626
<code>[:SOURCE<hw>]:BB:EUTRa:DL:CA:CELL<ch0>:UDConf</code>	627
<code>[:SOURCE<hw>]:BB:EUTRa:DL:CA:CELL<ch0>:SPSConf</code>	627
<code>[:SOURCE<hw>]:BB:EUTRa:DL:CA:CELL<ch0>:INDex</code>	627
<code>[:SOURCE<hw>]:BB:EUTRa:DL:CA:CELL<ch0>:POFFset</code>	628
<code>[:SOURCE<hw>]:BB:EUTRa:DL:CA:CELL<ch0>:PSTart</code>	628
<code>[:SOURCE<hw>]:BB:EUTRa:DL:CA:CELL<ch0>:SCINdex</code>	628
<code>[:SOURCE<hw>]:BB:EUTRa:DL:CA:CELL<ch0>:TDElay</code>	628
<code>[:SOURCE<hw>]:BB:EUTRa:DL:CA:CELL<ch0>:PHICh:DURation</code>	629
<code>[:SOURCE<hw>]:BB:EUTRa:DL:CA:CELL<ch0>:PHICh:NGParameter</code>	629
<code>[:SOURCE<hw>]:BB:EUTRa:DL:CA:CELL<ch0>:STATE</code>	629

`[:SOURCE<hw>]:BB:EUTRa:DL:CA:STATE <CaGlobalState>`

Enables/disables the generation of several component carriers.

Parameters:

`<CaGlobalState>` 1 | ON | 0 | OFF
 *RST: OFF

Manual operation: See "[Activate Carrier Aggregation](#)" on page 74

`[:SOURCE<hw>]:BB:EUTRa:DL:CA:CELL<ch0>:BB <BasebandPath>`

Determines the baseband block that generates the selected component carrier.

Parameters:

`<BasebandPath>` A | B
 *RST: A

`[:SOURCE<hw>]:BB:EUTRa:DL:CA:CELL<ch0>:BW <Bandwidth>`

Sets the bandwidth of the corresponding component carrier/SCell.

Parameters:

`<Bandwidth>` BW1_40 | BW3_00 | BW5_00 | BW10_00 | BW15_00 |
 BW20_00
 *RST: BW10_00

Manual operation: See "[Bandwidth](#)" on page 74

[:SOURce<hw>]:BB:EUTRa:DL:CA:CELL<ch0>:CIF <CifPresent>

Defines whether the CIF is included in the PDCCH DCI formats transmitted from the corresponding SCell.

Parameters:

<CifPresent> 1 | ON | 0 | OFF
 *RST: 0

Manual operation: See "[CIF Present](#)" on page 75

[:SOURce<hw>]:BB:EUTRa:DL:CA:CELL<ch0>:DFReq <DeltaFreq>

Sets the frequency offset between the central frequency of the SCell and the frequency of the PCell.

Parameters:

<DeltaFreq> float
 Value range depends on the installed options, the number of cells and the cell bandwidth.
 Range: -40 to 40
 Increment: 0.1
 *RST: 0
 Default unit: MHz

Manual operation: See "[delta f / MHz](#)" on page 75

[:SOURce<hw>]:BB:EUTRa:DL:CA:CELL<ch0>:ID <PhysicalCellId>

Sets the physical Cell ID of the corresponding SCell.

Parameters:

<PhysicalCellId> integer
 Range: 0 to 503
 *RST: 0

Manual operation: See "[Physical Cell ID](#)" on page 74

[:SOURce<hw>]:BB:EUTRa:DL:CA:CELL<ch0>:DUPLexing <DIDuplexmode>

Selects the duplexing mode of the component carriers.

Parameters:

<DIDuplexmode> TDD | FDD | LAA
 *RST: FDD

Example:

```
SOURcel:BB:EUTRa:DL:CA:CELL0:DUPLexing TDD
SOURcel:BB:EUTRa:DL:CA:CELL1:UDConf 3
SOURcel:BB:EUTRa:DL:CA:CELL1:SPSConf 2

// SOURcel:BB:EUTRa:DL:CONF:MODE AUTO
// SOURcel:BB:EUTRa:DL:CA:CELL1:DUPLexing FDD
// SOURcel:BB:EUTRa:DL:CA:CELL2:DUPLexing TDD
// SOURcel:BB:EUTRa:DL:CA:CELL2:UDConf 1
// SOURcel:BB:EUTRa:DL:CA:CELL2:SPSConf
```

Options: TDD and FDD combination requires R&S SMM-K113
LAA requires R&S SMM-K119

Manual operation: See "[Duplexing](#)" on page 75

[:SOURce<hw>]:BB:EUTRa:DL:CA:CELL<ch0>:UDConf <DLCaTddULDLConf>

Sets the Uplink-Downlink Configuration number.

Parameters:

<DLCaTddULDLConf>integer

Range: 0 to 6
*RST: 0

Example: See [\[:SOURce<hw>\]:BB:EUTRa:DL:CA:CELL<ch0>:DUPLexing](#) on page 626

Options: R&S SMM-K112

Manual operation: See "[TDD UL/DL Configuration](#)" on page 75

[:SOURce<hw>]:BB:EUTRa:DL:CA:CELL<ch0>:SPSConf <DLCaTddSSConf>

Sets the special subframe configuration number.

Parameters:

<DLCaTddSSConf> integer

Range: 0 to 10
*RST: 0

Example: See [\[:SOURce<hw>\]:BB:EUTRa:DL:CA:CELL<ch0>:DUPLexing](#) on page 626

Options: R&S SMM-K112
R&S SMM-K119: special subframe configuration 10

Manual operation: See "[TDD Special Subframe Config](#)" on page 75

[:SOURce<hw>]:BB:EUTRa:DL:CA:CELL<ch0>:INDEX <CellIndex>

Sets the cell index of the corresponding SCell.

The cell index of the PCell is always 0.

Parameters:

<CellIndex> integer
 Range: 1 to 7
 *RST: 1

Manual operation: See "[Cell Index](#)" on page 74

[:SOURCE<hw>]:BB:EUTRa:DL:CA:CELL<ch0>:POFFset <PowerOffset>

Sets the power offset of the SCells relative to the power level of the PCell.

Parameters:

<PowerOffset> float
 Range: -80 to 80
 Increment: 0.01
 *RST: 0

Manual operation: See "[Power / dB](#)" on page 78

[:SOURCE<hw>]:BB:EUTRa:DL:CA:CELL<ch0>:PStart <PdschStart>

Sets the starting symbol of the PDSCH for the corresponding SCell.

Parameters:

<PdschStart> integer
 Range: 1 to 4
 *RST: 2

Manual operation: See "[PDSCH Start](#)" on page 76

[:SOURCE<hw>]:BB:EUTRa:DL:CA:CELL<ch0>:SCINdex <SchedCellIndex>

Defines the component carrier/cell that signals the UL and DL grants for the selected SCell.

Parameters:

<SchedCellIndex> integer
 Range: 0 to 7
 *RST: 0

Manual operation: See "[sched. Cell Index](#)" on page 76

[:SOURCE<hw>]:BB:EUTRa:DL:CA:CELL<ch0>:TDElay <TimeDelay>

Sets the time delay of the SCell relative to the PCell.

Parameters:

<TimeDelay> integer
 Range: 0 to 700000
 *RST: 0

Manual operation: See ["Delay / ns"](#) on page 78

[:SOURce<hw>]:BB:EUTRa:DL:CA:CELL<ch0>:PHICH:DURation <Duration>

Sets the PHICH duration and defines the allocation of the PHICH resource element groups over the OFDM symbols.

Parameters:

<Duration> NORMAL | EXTended
NORMAL
 The first OFDM symbol is allocated
EXTended
 The first three OFDM symbols are allocated.
 *RST: NORMAL

Manual operation: See ["PHICH Duration"](#) on page 77

[:SOURce<hw>]:BB:EUTRa:DL:CA:CELL<ch0>:PHICH:NGParameter
 <NgParameter>

Sets the parameter N_g according to [TS 36.211](#).

Parameters:

<NgParameter> NG1_6 | NG1_2 | NG1 | NG2 | NGCustom
NG1_6 | NG1_2 | NG1 | NG2
 Determines the number of PHICH groups.
NGCustom
 The number of PHICH groups are set with the command [:
[SOURce<hw>\]:BB:EUTRa:DL\[:SUBF<st0>\]:ENCC:](#)
[PHICH\[:CELL<ccidx>\]:NOGRoups.](#)
 *RST: NG1_6

Manual operation: See ["PHICH N_g"](#) on page 76

[:SOURce<hw>]:BB:EUTRa:DL:CA:CELL<ch0>:STATE <CellState>

Activates/deactivates the component carrier/SCell.

Parameters:

<CellState> 1 | ON | 0 | OFF
 *RST: OFF

Manual operation: See ["State"](#) on page 78

10.13 CSI-RS

Example: Enabling a CSI-RS transmission

The following is a simple example of how to configure a CSI-RS transmission.

```

SOURCEl:BB:EUTRa:PRESet
SOURCEl:BB:EUTRa:DUPLexing FDD
SOURCEl:BB:EUTRa:LINK DOWN
SOURCEl:BB:EUTRa:DL:CSIS:ZP 4112
SOURCEl:BB:EUTRa:DL:CSIS:ZPI 5
SOURCEl:BB:EUTRa:DL:CSIS:ZPDelta?
// Response: 0
SOURCEl:BB:EUTRa:DL:CSIS:ZPT?
// Response: 10
SOURCEl:BB:EUTRa:DL:CSIS:STATe ON
SOURCEl:BB:EUTRa:DL:CSIS:NAP AP1
SOURCEl:BB:EUTRa:DL:CSIS:SFI 1
SOURCEl:BB:EUTRa:DL:CSIS:CONFig0 0
SOURCEl:BB:EUTRa:DL:CSIS:SFDelta?
// Response: 1
SOURCEl:BB:EUTRa:DL:CSIS:SFT?
// Response: 5
SOURCEl:BB:EUTRa:DL:CSIS:POW 0.5

SOURCEl:BB:EUTRa:DL:SFSelection 1
SOURCEl:BB:EUTRa:DL:SUBF1:ALCount 2
SOURCEl:BB:EUTRa:DL:SUBF1:ALLoc1:CW1:PHYSbits?
// Response: 276
SOURCEl:BB:EUTRa:DL:SUBF1:ALLoc1:CAW ON
// Response: 272
SOURCEl:BB:EUTRa:DL:USER1:CAW:STATe ON
SOURCEl:BB:EUTRa:STATe 1

[:SOURCEl<hw>]:BB:EUTRa:DL:CSIS[:CELL<ch0>]:CONFig[<st>]..... 631
[:SOURCEl<hw>]:BB:EUTRa:DL:CSIS[:CELL<ch0>]:NAP..... 631
[:SOURCEl<hw>]:BB:EUTRa:DL:CSIS[:CELL<ch0>]:POW..... 631
[:SOURCEl<hw>]:BB:EUTRa:DL:CSIS[:CELL<ch0>]:SFDelta?..... 632
[:SOURCEl<hw>]:BB:EUTRa:DL:CSIS[:CELL<ch0>]:SFI..... 632
[:SOURCEl<hw>]:BB:EUTRa:DL:CSIS[:CELL<ch0>]:SFT?..... 632
[:SOURCEl<hw>]:BB:EUTRa:DL:CSIS[:CELL<ch0>]:STATe..... 632
[:SOURCEl<hw>]:BB:EUTRa:DL:CSIS[:CELL<ch0>][:ZPRS<st0>]:ZP..... 633
[:SOURCEl<hw>]:BB:EUTRa:DL:CSIS[:CELL<ch0>][:ZPRS<st0>]:ZPDelta?..... 633
[:SOURCEl<hw>]:BB:EUTRa:DL:CSIS[:CELL<ch0>][:ZPRS<st0>]:ZPI..... 634
[:SOURCEl<hw>]:BB:EUTRa:DL:CSIS[:CELL<ch0>][:ZPRS<st0>]:ZPT?..... 634
[:SOURCEl<hw>]:BB:EUTRa:DL:CSIS[:CELL<ch0>]:DWPTs..... 634
[:SOURCEl<hw>]:BB:EUTRa:DL:CSIS[:CELL<ch0>]:NCFG..... 635
[:SOURCEl<hw>]:BB:EUTRa:DL:CSIS[:CELL<ch0>]:SCID..... 635

```

[:SOURce<hw>]:BB:EUTRa:DL:CSIS[:CELL<ch0>]:CDMType.....	636
[:SOURce<hw>]:BB:EUTRa:DL:CSIS[:CELL<ch0>]:FRDensity[<st>].....	636
[:SOURce<hw>]:BB:EUTRa:DL:CSIS[:CELL<ch0>]:TRANscomb[<st>].....	636

[[:SOURce<hw>]:BB:EUTRa:DL:CSIS[:CELL<ch0>]:CONFig[<st>] <CsiRsConfig>

Defines the CSI-RS configuration used for the current cell and for which the UE assumes non-zero transmission power.

Suffix:

<st> 0
CSI-RS configuration number

Parameters:

<CsiRsConfig> integer
Range: 0 to 31
*RST: 0

Example: See [Example"Enabling a CSI-RS transmission"](#) on page 630.

Options: CELL<ch0> requires R&S SMM-K85
Suffix <st> requires R&S SMM-K119

Manual operation: See ["Resource Configuration"](#) on page 114

[[:SOURce<hw>]:BB:EUTRa:DL:CSIS[:CELL<ch0>]:NAP <CsiRsNumAp>

Defines the number of antenna ports the CSI-RS are transmitted on.

Parameters:

<CsiRsNumAp> AP1 | AP2 | AP4 | AP8
*RST: AP1

Example: See [Example"Enabling a CSI-RS transmission"](#) on page 630

Manual operation: See ["Number of AP per CSI-RS Configuration"](#) on page 113

[[:SOURce<hw>]:BB:EUTRa:DL:CSIS[:CELL<ch0>]:POW <CsiRsPow>

Boosts the CSI-RS power compared to the cell-specific reference signals.

Parameters:

<CsiRsPow> float
Range: -8 to 15
Increment: 0.001
*RST: 0

Example: See [Example"Enabling a CSI-RS transmission"](#) on page 630.

Options: CELL<ch0> requires R&S SMM-K85

Manual operation: See ["CSI-RS Power"](#) on page 113

[[:SOURce<hw>]:BB:EUTRa:DL:CSIS[:CELL<ch0>]:SFDelta?

Sets the parameter subframe offset $\Delta_{\text{CSI-RS}}$ for cell-specific CSI-RS.

Return values:

<CsiRsOffs> integer
 Range: 0 to 79
 *RST: 0

Example: See [Example"Enabling a CSI-RS transmission"](#) on page 630.

Usage: Query only

Options: CELL<ch0> requires R&S SMM-K85

Manual operation: See "[Subframe Offset \(Delta_CSI-RS\)](#)" on page 113

[[:SOURce<hw>]:BB:EUTRa:DL:CSIS[:CELL<ch0>]:SFI <CsiRsSfConf>

Sets the parameter $I_{\text{CSI-RS}}$ for cell-specific CSI-RS.

Parameters:

<CsiRsSfConf> integer
 Range: 0 to 154
 *RST: 0

Example: See [Example"Enabling a CSI-RS transmission"](#) on page 630.

Options: CELL<ch0> requires R&S SMM-K85

Manual operation: See "[Subframe Config \(I_CSI-RS\)](#)" on page 113

[[:SOURce<hw>]:BB:EUTRa:DL:CSIS[:CELL<ch0>]:SFT?

Queires the parameter subframe configuration period $T_{\text{CSI-RS}}$ for cell-specific CSI-RS.

Return values:

<CsiRsPeriod> integer
 Range: 5 to 80
 *RST: 5

Example: See [Example"Enabling a CSI-RS transmission"](#) on page 630.

Usage: Query only

Options: CELL<ch0> requires R&S SMM-K85

Manual operation: See "[Periodicity \(T_CSI-RS\)](#)" on page 113

[[:SOURce<hw>]:BB:EUTRa:DL:CSIS[:CELL<ch0>]:STATE <CsiRsState>

Enables the transmission of a CSI-RS.

Parameters:

<CsiRsState> OFF | ON | 1 | 0
 *RST: OFF

Example: See [Example"Enabling a CSI-RS transmission"](#) on page 630.

Options: CELL<ch0> requires R&S SMM-K85

Manual operation: See "[CSI-RS State](#)" on page 112

[:SOURce<hw>]:BB:EUTRa:DL:CSIS[:CELL<ch0>][:ZPRS<st0>]:ZP <ZeroPow>

Sets the used CSI-RS configurations in the zero transmission power subframes.

Suffix:

<st0> 0|1
 Distinguishes between the primary (ZP CSI-RS #0) and the additional (ZP CSI-RS #1) zero-power CSI reference signal of a cell.

Parameters:

<ZeroPow> decimal value
 In the user interface, the 16 bits are set as a hexadecimal value.
 In the remote control, as a decimal value.
 Range: 0 to 65535
 Increment: 1
 *RST: 0

Example: See [Example"Enabling a CSI-RS transmission"](#) on page 630.

Options: CELL<ch0> requires R&S SMM-K85
 ZPRS<st0> requires R&S SMM-K113

Manual operation: See "[ZeroPowerCSI-RS \(HEX\)](#)" on page 112

[:SOURce<hw>]:BB:EUTRa:DL:CSIS[:CELL<ch0>][:ZPRS<st0>]:ZPDelta?

Sets the parameter subframe offset $\Delta_{\text{CSI-RS}}$ for CSI-RS with zero transmission power.

Suffix:

<st0> 0|1
 Distinguishes between the primary (ZP CSI-RS #0) and the additional (ZP CSI-RS #1) zero-power CSI reference signal of a cell.

Return values:

<ZeroPowOffs> integer

Example: See [Example"Enabling a CSI-RS transmission"](#) on page 630.

Usage: Query only

Options: CELL<ch0> requires R&S SMM-K85
 ZPRS<st0> requires R&S SMM-K113

Manual operation: See ["Subframe Offset \(Delta_CSI-RS\)"](#) on page 112

[:SOURCE<hw>]:BB:EUTRa:DL:CSIS[:CELL<ch0>][:ZPRS<st0>]:ZPI
<ZeroPowConf>

Sets the parameter $I_{\text{CSI-RS}}$ for CSI-RS with zero transmission power.

Suffix:

<st0> 0|1
 Distinguishes between the primary (ZP CSI-RS #0) and the additional (ZP CSI-RS #1) zero-power CSI reference signal of a cell.

Parameters:

<ZeroPowConf> integer
 Range: 0 to 154
 *RST: 0

Example: See [Example"Enabling a CSI-RS transmission"](#) on page 630.

Options: CELL<ch0> requires R&S SMM-K85
 ZPRS<st0> requires R&S SMM-K113

Manual operation: See ["Subframe Config \(I_CSI-RS\)"](#) on page 112

[:SOURCE<hw>]:BB:EUTRa:DL:CSIS[:CELL<ch0>][:ZPRS<st0>]:ZPT?

Sets the parameter subframe configuration period $T_{\text{CSI-RS}}$ for CSI-RS with zero transmission power.

Suffix:

<st0> 0|1
 Distinguishes between the primary (ZP CSI-RS #0) and the additional (ZP CSI-RS #1) zero-power CSI reference signal of a cell.

Return values:

<ZeroPowPer> integer

Example: See [Example"Enabling a CSI-RS transmission"](#) on page 630.

Usage: Query only

Options: CELL<ch0> requires R&S SMM-K85
 ZPRS<st0> requires R&S SMM-K113

Manual operation: See ["Periodicity \(T_CSI-RS\)"](#) on page 112

[:SOURCE<hw>]:BB:EUTRa:DL:CSIS[:CELL<ch0>]:DWPTs <DwPTS>

Enables transmission of the CSI-RS in the Downlink Pilot Time Slot (DwPTS) parts of the TDD frame.

Parameters:

<DwPTS> 1 | ON | 0 | OFF
 *RST: 0

Example:

See [\[:SOURce<hw>\]:BB:EUTRa:DL:CSIS\[:CELL<ch0>\]:NCFG](#) on page 635.

Options:

R&S SMM-K119

Manual operation: See ["CSI-RS in DwPTS"](#) on page 111

[:SOURce<hw>]:BB:EUTRa:DL:CSIS[:CELL<ch0>]:NCFG <NumberOfConfigs>

Sets the number of CSI-RS configurations.

Parameters:

<NumberOfConfigs> 1 | 2 | 3 | 4 | 5 | 7
 *RST: 1

Example:

```
SOURce1:BB:EUTRa:DL:CSIS:CELL0:STATE 1
SOURce1:BB:EUTRa:DL:CSIS:CELL0:DWPTS 1

SOURce1:BB:EUTRa:DL:CSIS:CELL0:NCFG 2
SOURce1:BB:EUTRa:DL:CSIS:CELL0:CDMType 4
SOURce1:BB:EUTRa:DL:CSIS:CELL0:NAP?
// AP8
SOURce1:BB:EUTRa:DL:CSIS:CELL0:CONFig0 1
SOURce1:BB:EUTRa:DL:CSIS:CELL0:FRDensity0 1
SOURce1:BB:EUTRa:DL:CSIS:CELL0:TRANscomb0 0
SOURce1:BB:EUTRa:DL:CSIS:CELL0:CONFig1 2
SOURce1:BB:EUTRa:DL:CSIS:CELL0:FRDensity1 D12
SOURce1:BB:EUTRa:DL:CSIS:CELL0:TRANscomb1 1
...
```

See also [Example"Enabling a CSI-RS transmission"](#) on page 630.

Options:

R&S SMM-K119

Manual operation: See ["Number of CSI-RS Configurations"](#) on page 112

[:SOURce<hw>]:BB:EUTRa:DL:CSIS[:CELL<ch0>]:SCID <ScramblingId>

Sets the additional scrambling identity n_ID used to generate the NonZeroTxPower CSI-RS.

Parameters:

<ScramblingId> integer
 Range: 0 to 503

Example:

See [Example"Enabling a CSI-RS transmission"](#) on page 630.

Options:

R&S SMM-K112

Manual operation: See ["Scrambling Identity \(n_ID\)"](#) on page 113

[:SOURce<hw>]:BB:EUTRa:DL:CSIS[:CELL<ch0>]:CDMType <CDMType>

Sets the higher-level parameter `CDMType` that influence the antenna port mapping of the CSI-RS.

Parameters:

<CDMType> 2 | 4 | 8

*RST: 2

Example: See [\[:SOURce<hw>\]:BB:EUTRa:DL:CSIS\[:CELL<ch0>\]:NCFG](#) on page 635.

Options: R&S SMM-K119

Manual operation: See ["CDMType"](#) on page 114

**[:SOURce<hw>]:BB:EUTRa:DL:CSIS[:CELL<ch0>]:FRDensity[<st>]
<CsiRFreqDensity>**

Sets the parameter `NZP-FrequencyDensity`.

Parameters:

<CsiRFreqDensity> D1 | D12 | D13

*RST: 1

Example: See [\[:SOURce<hw>\]:BB:EUTRa:DL:CSIS\[:CELL<ch0>\]:NCFG](#) on page 635.

Options: R&S SMM-K119

Manual operation: See ["Frequency Density"](#) on page 114

**[:SOURce<hw>]:BB:EUTRa:DL:CSIS[:CELL<ch0>]:TRANScomb[<st>]
<CsiRsTransComb>**

Sets the parameter `NZP-TransmissionComb`.

Parameters:

<CsiRsTransComb> 0 | 1 | 2

*RST: 0

Example: See [\[:SOURce<hw>\]:BB:EUTRa:DL:CSIS\[:CELL<ch0>\]:NCFG](#) on page 635.

Options: R&S SMM-K119

Manual operation: See ["Transmission Comb"](#) on page 115

10.14 LAA and DRS

Option: R&S SMM-K119

Example: Enabling a LAA SCell and configuring of one LAA burst

The following is a simple example of how to configure a LAA transmission.

```

SOURCEl:BB:EUTRa:PRESet
SOURCEl:BB:EUTRa:STDMoDe LTE
SOURCEl:BB:EUTRa:DUPLexing FDD
SOURCEl:BB:EUTRa:LINK DOWN

// enable a LAA SCell
SOURCEl:BB:EUTRa:DL:CONF:MoDE AUTO
SOURCEl:BB:EUTRa:DL:CA:CELL1:DUPLexing LAA
SOURCEl:BB:EUTRa:DL:CA:CELL1:BW BW20_00
SOURCEl:BB:EUTRa:DL:CA:CELL1:DFReq 70
SOURCEl:BB:EUTRa:DL:CA:CELL1:CIF 1
SOURCEl:BB:EUTRa:DL:CA:CELL1:STATe 1
SOURCEl:BB:EUTRa:DL:CA:STATe 1
// configure the DRS
SOURCEl:BB:EUTRa:DL:DRS:CELL1:PERioDicity P40
SOURCEl:BB:EUTRa:DL:DRS:CELL1:OFFSet 1
SOURCEl:BB:EUTRa:DL:DRS:CELL1:DUratiOn DUR1
SOURCEl:BB:EUTRa:DL:DRS:CELL1:PATtern 0
SOURCEl:BB:EUTRa:DL:DRS:CELL1:STATe 1
// SOURCEl:BB:EUTRa:DL:DRS:CELL2:PERioDicity P80
// SOURCEl:BB:EUTRa:DL:DRS:CELL2:DUratiOn DUR5
// SOURCEl:BB:EUTRa:DL:DRS:CELL2:PATtern 1,0,-1,4,5
SOURCEl:BB:EUTRa:DL:DRS:CELL1:CDSTate 1
SOURCEl:BB:EUTRa:DL:DRS:CELL1:ZPNuM 1
SOURCEl:BB:EUTRa:DL:DRS:CELL1:CSIRs1:ZP 4
SOURCEl:BB:EUTRa:DL:DRS:CELL1:CSIRs1:ZPI 1
SOURCEl:BB:EUTRa:DL:DRS:CELL1:CSIRs1:ZPT?
// 5
SOURCEl:BB:EUTRa:DL:DRS:CELL1:CSIRs1:ZPDelta?
// 1
SOURCEl:BB:EUTRa:DL:DRS:CELL1:NZPNuM 2
SOURCEl:BB:EUTRa:DL:DRS:CELL1:CSIRs1:NZSCid 1
SOURCEl:BB:EUTRa:DL:DRS:CELL1:CSIRs1:NZConfig C2
SOURCEl:BB:EUTRa:DL:DRS:CELL1:CSIRs1:NZSFoffset?
SOURCEl:BB:EUTRa:DL:DRS:CELL1:CSIRs1:NZQoffset M2

// set Tx mode and UL carrier
SOURCEl:BB:EUTRa:DL:USER1:CELL0:TXM M2
SOURCEl:BB:EUTRa:DL:USER1:CELL1:TXM M2
SOURCEl:BB:EUTRa:DL:USER1:ULCA0:STATe 1

// configure the LAA burst

```

```

SOURCEl:BB:EUTRa:DL:LAA:CELL1:NUMBursts 1
SOURCEl:BB:EUTRa:DL:LAA:CEINDEX SC1
SOURCEl:BB:EUTRa:DL:LAA:CELL1:BURSt0:STSFrame 5
SOURCEl:BB:EUTRa:DL:LAA:CELL1:BURSt0:STSLOT SEC
SOURCEl:BB:EUTRa:DL:LAA:CELL1:BURSt0:DURation 3
SOURCEl:BB:EUTRa:DL:LAA:CELL1:BURSt0:LSFSymbols SY11
SOURCEl:BB:EUTRa:DL:LAA:CELL1:BURSt0:C1Mode N1N
SOURCEl:BB:EUTRa:DL:LAA:CELL1:BURSt0:EPDCCh F2
// configure the DCI format 1C
SOURCEl:BB:EUTRa:DL:SUBF0:ENCC:PDCCh:EXTC:SITem 0
SOURCEl:BB:EUTRa:DL:SUBF0:ENCC:PDCCh:EXTC:ITEM0:USER CCRnti
SOURCEl:BB:EUTRa:DL:SUBF0:ENCC:PDCCh:EXTC:ITEM0:UEID?
// 65532

SOURCEl:BB:EUTRa:DL:SUBF0:ENCC:PDCCh:EXTC:ITEM0:DCIFmt?
// F1C
SOURCEl:BB:EUTRa:DL:SUBF0:ENCC:PDCCh:EXTC:ITEM0:SESpace?
// COMM
SOURCEl:BB:EUTRa:DL:SUBF0:ENCC:PDCCh:EXTC:ITEM0:CELL 1
SOURCEl:BB:EUTRa:DL:SUBF0:ENCC:PDCCh:EXTC:ITEM0:PDCChtype?
// PDCC
SOURCEl:BB:EUTRa:DL:SUBF0:ENCC:PDCCh:EXTC:ITEM0:PFMT 2
SOURCEl:BB:EUTRa:DL:SUBF0:ENCC:PDCCh:EXTC:ITEM0:DCIConf:LAASubframe 1
SOURCEl:BB:EUTRa:DL:SUBF0:ENCC:PDCCh:EXTC:ITEM0:DCIConf:BITData?
// "000 1000 0000 0000"

// generate a waveform and save the configuration
SOURCEl:FREQuency:CW 2143000000
SOURCEl:BB:EUTRa:SLENgth 40
SOURCEl:BB:EUTRa:STATe 1
SOURCEl:BB:EUTRa:WAVEform:CREate "/var/user/laa.wv"
SOURCEl:BB:EUTRa:SETTING:STORe "/var/user/LAA"

[:SOURCEl<hw>]:BB:EUTRa:DL:DRS:CELL<ch0>:STATe..... 639
[:SOURCEl<hw>]:BB:EUTRa:DL:DRS:CELL<ch0>:PERiodicity..... 639
[:SOURCEl<hw>]:BB:EUTRa:DL:DRS:CELL<ch0>:OFFSet..... 639
[:SOURCEl<hw>]:BB:EUTRa:DL:DRS:CELL<ch0>:DURation..... 640
[:SOURCEl<hw>]:BB:EUTRa:DL:DRS:CELL<ch0>:PATtern..... 640
[:SOURCEl<hw>]:BB:EUTRa:DL:DRS:CELL<ch0>:CDState..... 640
[:SOURCEl<hw>]:BB:EUTRa:DL:DRS:CELL<ch0>:ZPNum..... 640
[:SOURCEl<hw>]:BB:EUTRa:DL:DRS:CELL<ch0>:NZPNum..... 641
[:SOURCEl<hw>]:BB:EUTRa:DL:DRS:CELL<ch0>:CSIRs<st>:ZP..... 641
[:SOURCEl<hw>]:BB:EUTRa:DL:DRS:CELL<ch0>:CSIRs<st>:ZPI..... 641
[:SOURCEl<hw>]:BB:EUTRa:DL:DRS:CELL<ch0>:CSIRs<st>:ZPT?..... 642
[:SOURCEl<hw>]:BB:EUTRa:DL:DRS:CELL<ch0>:CSIRs<st>:ZPDelta?..... 642
[:SOURCEl<hw>]:BB:EUTRa:DL:DRS:CELL<ch0>:CSIRs<st>:NZSCid..... 642
[:SOURCEl<hw>]:BB:EUTRa:DL:DRS:CELL<ch0>:CSIRs<st>:NZConfig..... 643
[:SOURCEl<hw>]:BB:EUTRa:DL:DRS:CELL<ch0>:CSIRs<st>:NZSFOffset..... 643
[:SOURCEl<hw>]:BB:EUTRa:DL:DRS:CELL<ch0>:CSIRs<st>:NZQOffset..... 644
[:SOURCEl<hw>]:BB:EUTRa:DL:LAA:CEINDEX..... 644

```

<code>[:SOURce<hw>]:BB:EUTRa:DL:LAA:CELL<ch0>:NUMBursts</code>	644
<code>[:SOURce<hw>]:BB:EUTRa:DL:LAA:CELL<ch0>:BURSt<st0>:STSFrame</code>	645
<code>[:SOURce<hw>]:BB:EUTRa:DL:LAA:CELL<ch0>:BURSt<st0>:STSLot</code>	645
<code>[:SOURce<hw>]:BB:EUTRa:DL:LAA:CELL<ch0>:BURSt<st0>:DURation</code>	645
<code>[:SOURce<hw>]:BB:EUTRa:DL:LAA:CELL<ch0>:BURSt<st0>:ENSFrame?</code>	646
<code>[:SOURce<hw>]:BB:EUTRa:DL:LAA:CELL<ch0>:BURSt<st0>:LSFSymbols</code>	646
<code>[:SOURce<hw>]:BB:EUTRa:DL:LAA:CELL<ch0>:BURSt<st0>:C1Mode</code>	646
<code>[:SOURce<hw>]:BB:EUTRa:DL:LAA:CELL<ch0>:BURSt<st0>:EPDCCh</code>	647
<code>[:SOURce<hw>]:BB:EUTRa:DL[:SUBF<st0>]:ENCC:PDCCh:EXTC:ITEM<ch0>: DCIConf:LAASubframe</code>	647

`[:SOURce<hw>]:BB:EUTRa:DL:DRS:CELL<ch0>:STATe <DrsState>`

Enables the selected DRS occasion configuration.

Parameters:

`<DrsState>` 1 | ON | 0 | OFF
 *RST: 0

Example: See [Example"Enabling a LAA SCell and configuring of one LAA burst"](#) on page 637.

Manual operation: See ["State"](#) on page 117

`[:SOURce<hw>]:BB:EUTRa:DL:DRS:CELL<ch0>:PERiodicity <DrsPeriodicity>`

Sets the DRS periodicity.

Parameters:

`<DrsPeriodicity>` P40 | P80 | P160
 *RST: P40

Example: See [Example"Enabling a LAA SCell and configuring of one LAA burst"](#) on page 637.

Manual operation: See ["Periodicity"](#) on page 117

`[:SOURce<hw>]:BB:EUTRa:DL:DRS:CELL<ch0>:OFFSet <DrsOffset>`

Offsets the DRS start within the DRS occasion.

Parameters:

`<DrsOffset>` integer
 Range: 0 to 159
 *RST: 0

Example: See [Example"Enabling a LAA SCell and configuring of one LAA burst"](#) on page 637.

Manual operation: See ["Offset"](#) on page 118

[:SOURCE<hw>]:BB:EUTRa:DL:DRS:CELL<ch0>:DURATION <DrsDuration>

Sets the DRS duration.

Parameters:

<DrsDuration> DUR1 | DUR2 | DUR3 | DUR4 | DUR5

DUR1

For LAA SCells, the DRS is always 1 ms long

DUR2|DUR3|DUR4|DUR5

In FDD mode, sets duration of 2 ms to 5 ms

*RST: DUR1

Example: See [Example"Enabling a LAA SCell and configuring of one LAA burst"](#) on page 637.

Manual operation: See ["Duration"](#) on page 118

[:SOURCE<hw>]:BB:EUTRa:DL:DRS:CELL<ch0>:PATTERN

Defines the subframes in that DRS is transmitted for up to 20 DRS occasions.

Example: See [Example"Enabling a LAA SCell and configuring of one LAA burst"](#) on page 637.

Manual operation: See ["Pattern"](#) on page 118

[:SOURCE<hw>]:BB:EUTRa:DL:DRS:CELL<ch0>:CDSTATE <CsiRsState>

Enables defining the CSI-RS part of the DRS.

Parameters:

<CsiRsState> 1 | ON | 0 | OFF

*RST: 0

Example: See [Example"Enabling a LAA SCell and configuring of one LAA burst"](#) on page 637.

Manual operation: See ["CSI-RS Part of DRS"](#) on page 119

[:SOURCE<hw>]:BB:EUTRa:DL:DRS:CELL<ch0>:ZPNUM <NumZeroPwrConf>

Enables up to 5 ZeroTxPower CSI-RS within the DRS period.

Parameters:

<NumZeroPwrConf> integer

Range: 0 to 5

Example: See [Example"Enabling a LAA SCell and configuring of one LAA burst"](#) on page 637.

Manual operation: See ["ZeroTxPower/NonZeroTxPower CSI-RS Structure>Number of CSI-RS Configurations"](#) on page 119

[:SOURce<hw>]:BB:EUTRa:DL:DRS:CELL<ch0>:NZPNum <NumNonZeroPwrCo>

Enables up to 96 NonZeroTxPower CSI-RS within the DRS period.

Parameters:

<NumNonZeroPwrCo>integer

Range: 0 to 96

Example: See [Example"Enabling a LAA SCell and configuring of one LAA burst"](#) on page 637.

Manual operation: See ["ZeroTxPower/NonZeroTxPower CSI-RS Structure>Number of CSI-RS Configurations"](#) on page 119

[:SOURce<hw>]:BB:EUTRa:DL:DRS:CELL<ch0>:CSIRs<st>:ZP <ZeroPower>

Sets the used CSI-RS configurations in the zero transmission power subframes.

Suffix:

<st>

1 to 5

Selects the zero-power CSI reference signal (ZeroTxPower CSI-RS)

Value range depends on the value set with the command [:

[SOURce<hw>\]:BB:EUTRa:DL:DRS:CELL<ch0>:ZPNum](#)

Parameters:

<ZeroPower>

integer

In the user interface, the 16 bits are set as a hexadecimal value. In the remote control, as a decimal value.

Range: 0 to 16 bit

Example: See [Example"Enabling a LAA SCell and configuring of one LAA burst"](#) on page 637.

Manual operation: See ["ZeroPower CSI-RS"](#) on page 119

[:SOURce<hw>]:BB:EUTRa:DL:DRS:CELL<ch0>:CSIRs<st>:ZPI <SfConfig>

Sets the parameter $I_{\text{CSI-RS}}$.

Suffix:

<st>

1 to 5

Selects the zero-power CSI reference signal (ZeroTxPower CSI-RS)

Value range depends on the value set with the command [:

[SOURce<hw>\]:BB:EUTRa:DL:DRS:CELL<ch0>:ZPNum](#)

Parameters:

<SfConfig>

integer

Range: 0 to 154

Example: See [Example"Enabling a LAA SCell and configuring of one LAA burst"](#) on page 637.

Manual operation: See ["Subframe Config \(I_CSI-RS\)"](#) on page 119

[:SOURce<hw>]:BB:EUTRa:DL:DRS:CELL<ch0>:CSIRs<st>:ZPT?

Queries the subframe configuration period $T_{\text{CSI-RS}}$ value.

Suffix:

<st> 1 to 5
 Selects the zero-power CSI reference signal (ZeroTxPower CSI-RS)
 Value range depends on the value set with the command [:
[SOURce<hw> \] :BB:EUTRa:DL:DRS:CELL<ch0>:ZPNum](#)

Return values:

<Periodicity> integer
 Range: 5 to 80

Example: See [Example"Enabling a LAA SCell and configuring of one LAA burst"](#) on page 637.

Usage: Query only

Manual operation: See ["Periodicity \(T_CSI-RS\)"](#) on page 119

[:SOURce<hw>]:BB:EUTRa:DL:DRS:CELL<ch0>:CSIRs<st>:ZPDelta?

Queries the subframe offset $\Delta_{\text{CSI-RS}}$ value.

Suffix:

<st> 1 to 5
 Selects the zero-power CSI reference signal (ZeroTxPower CSI-RS)
 Value range depends on the value set with the command [:
[SOURce<hw> \] :BB:EUTRa:DL:DRS:CELL<ch0>:ZPNum](#)

Return values:

<SFOffset> integer
 Range: 0 to 80

Example: See [Example"Enabling a LAA SCell and configuring of one LAA burst"](#) on page 637.

Usage: Query only

Manual operation: See ["Subframe Offset \(Delta_CSI-RS\)"](#) on page 119

**[:SOURce<hw>]:BB:EUTRa:DL:DRS:CELL<ch0>:CSIRs<st>:NZSCid
 <ScramblingId>**

Sets the individual scrambling identity of the NonZeroTxPower CSI-RS.

Suffix:
 <st> 1 to 96
 Selects the non-zero-power CSI reference signal (NonZeroTx-Power CSI-RS).
 Value range depends on the value set with the command [:
[SOURce<hw>](#)] : [BB](#) : [EUTRa](#) : [DL](#) : [DRS](#) : [CELL<ch0>](#) : [NZPNum](#)

Parameters:
 <ScramblingId> integer
 Range: 0 to 503
 *RST: 0

Example: See [Example"Enabling a LAA SCell and configuring of one LAA burst"](#) on page 637.

Manual operation: See ["Scrambling Identity \(n_ID\)"](#) on page 120

**[:[SOURce<hw>](#)] : [BB](#) : [EUTRa](#) : [DL](#) : [DRS](#) : [CELL<ch0>](#) : [CSIRs<st>](#) : [NZConfig](#)
 <NonZeroPwrConf>**

Sets the CSI-RS configuration.

Suffix:
 <st> 1 to 96
 Selects the non-zero-power CSI reference signal (NonZeroTx-Power CSI-RS)
 Value range depends on the value set with the command [:
[SOURce<hw>](#)] : [BB](#) : [EUTRa](#) : [DL](#) : [DRS](#) : [CELL<ch0>](#) : [NZPNum](#)

Parameters:
 <NonZeroPwrConf> 0 | 1 | 2 | 3 | 4 | 5 | 6 | 7 | 8 | 9 | 10 | 11 | 12 | 13 | 14 | 15 | 16 |
 17 | 18 | 19 | 20 | 21 | 22 | 23 | 24 | 25 | 26 | 27 | 28 | 29 | 30 | 31
 Values outside the permitted discrete values are rounded down.
 *RST: 0

Example: See [Example"Enabling a LAA SCell and configuring of one LAA burst"](#) on page 637.

Manual operation: See ["CSI-RS Configuration"](#) on page 120

**[:[SOURce<hw>](#)] : [BB](#) : [EUTRa](#) : [DL](#) : [DRS](#) : [CELL<ch0>](#) : [CSIRs<st>](#) : [NZSFoffset](#)
 <NonZeroPSfOffs>**

Queries the subframe offset between the SSS and the CSI-RS in a DRS.

Suffix:
 <st> 1 to 96
 Selects the non-zero-power CSI reference signal (NonZeroTx-Power CSI-RS).
 Value range depends on the value set with the command [:
[SOURce<hw>](#)] : [BB](#) : [EUTRa](#) : [DL](#) : [DRS](#) : [CELL<ch0>](#) : [NZPNum](#)

Parameters:

<NonZeroPSfOffs> integer
Range: 0 to 4

Example: See [Example"Enabling a LAA SCell and configuring of one LAA burst"](#) on page 637.

Manual operation: See ["Subframe Offset with SSS"](#) on page 120

[:SOURce<hw>]:BB:EUTRa:DL:DRS:CELL<ch0>:CSIRs<st>:NZQoffset
<NonZeroPQOffs>

Sets the Q-offset.

Suffix:

<st> 1 to 96
Selects the non-zero-power CSI reference signal (NonZeroTx-Power CSI-RS)
Value range depends on the value set with the command [\[:SOURce<hw> \] :BB:EUTRa:DL:DRS:CELL<ch0>:NZPNum](#)

Parameters:

<NonZeroPQOffs> -24 | -22 | -20 | -18 | -16 | -14 | -12 | -10 | -8 | -6 | -5 | -4 | -3 | -2 |
-1 | 0 | 1 | 2 | 3 | 4 | 5 | 6 | 8 | 10 | 12 | 14 | 16 | 18 | 20 | 22 | 24
Positive values outside the permitted discrete values are rounded down; negative values are rounded up.
*RST: 0

Example: See [Example"Enabling a LAA SCell and configuring of one LAA burst"](#) on page 637.

Manual operation: See ["Q-Offset"](#) on page 120

[:SOURce<hw>]:BB:EUTRa:DL:LAA:CEIndex <CellIndex>

Selects the LAA SCell for that the LAA is configured.

Parameters:

<CellIndex> SC1 | SC2 | SC3 | SC4 | NONE
*RST: SC1

Example: See [Example"Enabling a LAA SCell and configuring of one LAA burst"](#) on page 637.

Manual operation: See ["LAA Cell"](#) on page 161

[:SOURce<hw>]:BB:EUTRa:DL:LAA:CELL<ch0>:NUMBursts <NumberOfBursts>

Set the number of LAA bursts.

Parameters:

<NumberOfBursts> integer
 Range: 0 to 10
 *RST: 0

Example: See [Example"Enabling a LAA SCell and configuring of one LAA burst"](#) on page 637.

Manual operation: See ["Number of LAA Bursts"](#) on page 161

[:SOURCE<hw>]:BB:EUTRa:DL:LAA:CELL<ch0>:BURSt<st0>:STSFramE
 <StartingSF>

Sets the first subframe of the LAA burst.

Parameters:

<StartingSF> integer
 Range: 0 to 39
 *RST: 0

Example: See [Example"Enabling a LAA SCell and configuring of one LAA burst"](#) on page 637.

Manual operation: See ["Starting Subframe"](#) on page 161

[:SOURCE<hw>]:BB:EUTRa:DL:LAA:CELL<ch0>:BURSt<st0>:STSLot
 <StartingSlots>

Sets the starting slot.

Parameters:

<StartingSlots> FIRSt | SECond
FIRSt
 s0: first slot of a subframe
SECond
 s7: second slot of a subframe
 *RST: FIRSt

Example: See [Example"Enabling a LAA SCell and configuring of one LAA burst"](#) on page 637.

Manual operation: See ["Starting Symbol"](#) on page 161

[:SOURCE<hw>]:BB:EUTRa:DL:LAA:CELL<ch0>:BURSt<st0>:DURation
 <Duration>

Sets the duration of the LAA burst.

Parameters:

<Duration> integer
 Range: 1 to 10
 *RST: 10

Example: See [Example"Enabling a LAA SCell and configuring of one LAA burst"](#) on page 637.

Manual operation: See ["Burst Duration \(ms\)"](#) on page 161

[:SOURce<hw>]:BB:EUTRa:DL:LAA:CELL<ch0>:BURSt<st0>:ENSFrame?

Queries the number of the last subframe of the LAA burst.

Return values:

<EndingSubframe> integer
 Range: 0 to 39
 *RST: 0

Example: See [Example"Enabling a LAA SCell and configuring of one LAA burst"](#) on page 637.

Usage: Query only

Manual operation: See ["Ending Subframe"](#) on page 162

**[:SOURce<hw>]:BB:EUTRa:DL:LAA:CELL<ch0>:BURSt<st0>:LSFSymbols
<LastSFSymb>**

Sets the number of OFDM symbols in the last subframe of the LAA burst.

Parameters:

<LastSFSymb> SY3 | SY6 | SY9 | SY10 | SY11 | SY12 | SY14
 *RST: SY14

Example: See [Example"Enabling a LAA SCell and configuring of one LAA burst"](#) on page 637.

Manual operation: See ["Number of Ending Symbols"](#) on page 161

**[:SOURce<hw>]:BB:EUTRa:DL:LAA:CELL<ch0>:BURSt<st0>:C1Mode
<DCI1CMode>**

Defines how the DCI format 1C is sent.

Parameters:

<DCI1CMode> MANual | N1 | N | N1N
 *RST: N1N

Example: See [Example"Enabling a LAA SCell and configuring of one LAA burst"](#) on page 637.

Manual operation: See ["LAA DCI 1C Mode"](#) on page 162

```
[ :SOURce<hw>]:BB:EUTRa:DL:LAA:CELL<ch0>:BURSt<st0>:EPDCch
  <EpdccchFormat>
```

Sets the (E)PDCCH format.

Parameters:

```
<EpdccchFormat>  F2 | F3
                  *RST:      F2
```

Example: See [Example"Enabling a LAA SCell and configuring of one LAA burst"](#) on page 637.

Manual operation: See ["\(E\)PDCCH Format"](#) on page 162

```
[ :SOURce<hw>]:BB:EUTRa:DL[:SUBF<st0>]:ENCC:PDCCh:EXTC:ITEM<ch0>:
  DCIConf:LAASubframe <DciLaaConf>
```

Sets the DCI format 1C field subframe configuration for LAA.

Parameters:

```
<DciLaaConf>      integer
                  Range:    0 to 15
                  *RST:    0
```

Example: See [Example"Enabling a LAA SCell and configuring of one LAA burst"](#) on page 637.

Manual operation: See ["DCI Format 1C for LAA"](#) on page 197

10.15 Enhanced PBCH, PDSCH, PMCH

[:SOURce<hw>]:BB:EUTRa:DL:PBCH:MIB.....	648
[:SOURce<hw>]:BB:EUTRa:DL:PBCH:SOFFset.....	648
[:SOURce<hw>]:BB:EUTRa:DL:PBCH:SRPeriod.....	648
[:SOURce<hw>]:BB:EUTRa:DL:PBCH:MSPare.....	649
[:SOURce<hw>]:BB:EUTRa:DL[:SUBF<st0>]:ALLoc<ch0>:CAW.....	649
[:SOURce<hw>]:BB:EUTRa:DL[:SUBF<st0>]:ALLoc<ch0>[:CW<user>]:CCODing:ISBSize...	649
[:SOURce<hw>]:BB:EUTRa:DL[:SUBF<st0>]:ALLoc<ch0>[:CW<user>]:CCODing:RVIndex...	650
[:SOURce<hw>]:BB:EUTRa:DL[:SUBF<st0>]:ALLoc<ch0>[:CW<user>]:CCODing:STATe.....	650
[:SOURce<hw>]:BB:EUTRa:DL[:SUBF<st0>]:ALLoc<ch0>[:CW<user>]:CCODing:TBSize....	650
[:SOURce<hw>]:BB:EUTRa:DL[:SUBF<st0>]:ALLoc<ch0>[:CW<user>]:PRECoding:AP.....	651
[:SOURce<hw>]:BB:EUTRa:DL[:SUBF<st0>]:ALLoc<ch0>[:CW<user>]:PRECoding:APM.....	651
[:SOURce<hw>]:BB:EUTRa:DL[:SUBF<st0>]:ALLoc<ch0>[:CW<user>]:PRECoding:	
CBIndex[<dir>].....	652
[:SOURce<hw>]:BB:EUTRa:DL[:CELL<ccid>]:SUBF<st0>]:ALLoc<ch0>:PUSCh:	
PRECoding:CBA.....	652
[:SOURce<hw>]:BB:EUTRa:DL[:SUBF<st0>]:ALLoc<ch0>[:CW<user>]:PRECoding:CDD.....	653
[:SOURce<hw>]:BB:EUTRa:DL[:SUBF<st0>]:ALLoc<ch0>[:CW<user>]:PRECoding:	
DAFormat.....	653

<code>[:SOURCE<hw>]:BB:EUTRa:DL[:SUBF<st0>]:ALLoc<ch0>[:CW<user>]:PRECoding: NOLayers.....</code>	653
<code>[:SOURCE<hw>]:BB:EUTRa:DL[:SUBF<st0>]:ALLoc<ch0>[:CW<user>]:PRECoding: SCHeme.....</code>	654
<code>[:SOURCE<hw>]:BB:EUTRa:DL[:SUBF<st0>]:ALLoc<ch0>[:CW<user>]:PRECoding:SCID....</code>	654
<code>[:SOURCE<hw>]:BB:EUTRa:DL[:SUBF<st0>]:ALLoc<ch0>[:CW<user>]:PRECoding: TRScheme.....</code>	655
<code>[:SOURCE<hw>]:BB:EUTRa:DL[:SUBF<st0>]:ALLoc<ch0>[:CW<user>]:SCRambling: STATE.....</code>	655
<code>[:SOURCE<hw>]:BB:EUTRa:DL[:SUBF<st0>]:ALLoc<ch0>[:CW<user>]:SCRambling:UEID...</code>	655

`[:SOURCE<hw>]:BB:EUTRa:DL:PBCH:MIB <State>`

Enables transmission of real MIB data.

Parameters:

`<State>` 1 | ON | 0 | OFF
*RST: ON

Example:

```
SOURCE1:BB:EUTRa:DL:SUBF0:ALLoc0:CW1:CONType?
// PBCH
SOURCE1:BB:EUTRa:DL:SUBF0:ALLoc0:CW1:SCRambling:STATE 1
SOURCE1:BB:EUTRa:DL:SUBF0:ALLoc0:CW1:CCODing:STATE 1
SOURCE1:BB:EUTRa:DL:PBCH:MIB 1
SOURCE1:BB:EUTRa:DL:PBCH:SOFFset 0
SOURCE1:BB:EUTRa:DL:PBCH:SRPeriod PERS
SOURCE1:BB:EUTRa:DL:SUBF0:ALLoc0:CW1:CCODing:TBSize 24
SOURCE1:BB:EUTRa:DL:SUBF0:ALLoc0:CW1:PHYSbits?
// 480
SOURCE1:BB:EUTRa:DL:PBCH:MSpare #H001,10
SOURCE1:BB:EUTRa:DL:SUBF0:ALLoc0:CW1:STATE 1
```

Manual operation: See "[MIB \(including SFN\)](#)" on page 211

`[:SOURCE<hw>]:BB:EUTRa:DL:PBCH:SOFFset <SfnOffset>`

Sets an offset for the start value of the SFN (System Frame Number).

Parameters:

`<SfnOffset>` integer
Range: 0 to 1020
Increment: 4
*RST: 0

Example: See `[:SOURCE<hw>]:BB:EUTRa:DL:PBCH:MIB` on page 648

Manual operation: See "[SFN Offset](#)" on page 211

`[:SOURCE<hw>]:BB:EUTRa:DL:PBCH:SRPeriod <SfnRestPeriod>`

Determines the time span after which the SFN (System Frame Number) restarts.

Parameters:

<SfnRestPeriod> PERLength | PER3gpp
 PER3gpp = "3GPP (1024 Frames)"
 PERLength = SFN restart period to the ARB sequence length
 *RST: PERLength

Example: See [:SOURCE<hw>] :BB:EUTRa:DL:PBCH:MIB on page 648

Example: Option:R&S SMM-K115
 See [Example"PBCH and SIB1-BR configuration"](#) on page 818.

Options: R&S SMM-K84

Manual operation: See ["SFN Restart Period"](#) on page 212

[:SOURCE<hw>] :BB:EUTRa:DL:PBCH:MSPare <MibSpareBits>

Sets the 10 spare bits in the PBCH transmission.

Parameters:

<MibSpareBits> 64 bit
 *RST: #H0,1

Example: See [:SOURCE<hw>] :BB:EUTRa:DL:PBCH:MIB on page 648

Manual operation: See ["MIB Spare Bits"](#) on page 212

[:SOURCE<hw>] :BB:EUTRa:DL[:SUBF<st0>]:ALLoc<ch0>:CAW <DICsiAware>

Determines the way the PDSCH is processed.

Parameters:

<DICsiAware> OFF | ON | 1 | 0
 *RST: OFF

Example: See [Example"Enabling a CSI-RS transmission"](#) on page 630

Manual operation: See ["CSI Awareness"](#) on page 208

[:SOURCE<hw>] :BB:EUTRa:DL[:SUBF<st0>]:ALLoc<ch0>[:CW<user>]:CCODing:
 ISBSize <SoftBufSize>

Sets the size of the IR soft buffer.

Parameters:

<SoftBufSize> integer
 Range: 800 to 3667200
 *RST: 3667200

Example:

```
SOUR:BB:EUTR:DL:SUBF9:ALL5:CW:DATA USER3
SOUR:BB:EUTR:DL:SUBF9:ALL5:PHYS?
Response: 2400
SOUR:BB:EUTR:DL:SUBF9:ALL5:CW2:CCOD:TBS 1500
SOUR:BB:EUTR:DL:SUBF9:ALL5:CW2:CCOD:ISBS 1600
SOUR:BB:EUTR:DL:SUBF9:ALL4:CW:DATA USER3
SOUR:BB:EUTR:DL:SUBF9:ALL4:CW2:CCOD:ISBS?
Response: 1600
```

Manual operation: See "[IR Soft Buffer Size \(PDSCH\)](#)" on page 212

**[:SOURce<hw>]:BB:EUTRa:DL[:SUBF<st0>]:ALLoc<ch0>[:CW<user>]:CCODing:
RVINdex <RedundVersIndex>**

Sets the redundancy version index.

Parameters:

<RedundVersIndex> integer
 Range: 0 to 3
 *RST: 0

Example:

```
BB:EUTR:DL:SUBF4:ALL5:CW2:CCOD:RVIN 2
```

Sets the redundancy version index to 2

Manual operation: See "[Redundancy Version Index \(PDSCH\)](#)" on page 212

**[:SOURce<hw>]:BB:EUTRa:DL[:SUBF<st0>]:ALLoc<ch0>[:CW<user>]:CCODing:
STATe <State>**

Enables/disables channel coding for the selected allocation and codeword.

Parameters:

<State> 1 | ON | 0 | OFF
 *RST: OFF

Example:

```
BB:EUTR:DL:SUBF4:ALL5:CW2:CCOD:STAT OFF
```

Manual operation: See "[State Channel Coding \(DL\)](#)" on page 210

**[:SOURce<hw>]:BB:EUTRa:DL[:SUBF<st0>]:ALLoc<ch0>[:CW<user>]:CCODing:
TBSize <TranspBlockSize>**

Sets the size of the transport block.

Note: The parameter depends on the content type and the global MIMO configuration.

Parameters:

<TranspBlockSize> integer
 Range: 1 to 1E7
 *RST: 1500

Example: BB:EUTR:DL:SUBF9:ALL5:PHYS?
 Queries the number of physical bits of allocation 5
 Response: 2400
 BB:EUTR:DL:SUBF4:ALL5:CW2:CCOD:TBS 1500
 Sets the transport block size to of allocation 5 to 1500 bits

Example: SOUR:BB:EUTR:DL:SUBF9:ALL5:CW:DATA USER3
 SOUR:BB:EUTR:DL:SUBF9:ALL5:PHYS?
 Response: 2400
 SOUR:BB:EUTR:DL:SUBF9:ALL5:CW:CCOD:TBS 1000
 SOUR:BB:EUTR:DL:SUBF9:ALL5:CW2:CCOD:TBS 1500
 SOUR:BB:EUTR:DL:SUBF9:ALL4:CW:DATA USER3
 SOUR:BB:EUTR:DL:SUBF9:ALL4:CW:CCOD:TBS?
 Response: 1000
 SOUR:BB:EUTR:DL:SUBF9:ALL4:CW2:CCOD:TBS?
 Response: 1500

Manual operation: See "[Transport Block Size/Payload \(DL\)](#)" on page 212

**[:SOURce<hw>]:BB:EUTRa:DL[:SUBF<st0>]:ALLoc<ch0>[:CW<user>]:
 PRECoding:AP <AntennaPorts>**

Sets the antenna port(s) for the selected transmission mode.

Parameters:

<AntennaPorts> AP7 | AP5 | AP8 | AP78 | AP79 | AP710 | AP711 | AP712 |
 AP713 | AP714 | AP107 | AP108 | AP109 | AP110 | AP107108 |
 AP107109 | AP11 | AP13 | AP1113 | AP7 | AP5 | AP8 | AP78 |
 AP79 | AP710 | AP711 | AP712 | AP713 | AP714 | AP11 | AP13 |
 AP1113 | AP107 | AP108 | AP109 | AP110 | AP107108 |
 AP107109
 Antenna port or antenna ports combination; the designation
 AP78 for example means AP7 and AP8
 *RST: AP5

Options:

R&S SMM-K84
 AP11|AP13|AP1113|AP107|AP108|AP109|AP110|AP107108|
 AP107109 require R&S SMM-K119

Manual operation: See "[Antenna Ports](#)" on page 206

**[:SOURce<hw>]:BB:EUTRa:DL[:SUBF<st0>]:ALLoc<ch0>[:CW<user>]:
 PRECoding:APM <AntPortMap>**

Sets the way that the logical antenna ports are mapped to the physical Tx-antennas.

See [Chapter 4.5, "DL antenna port mapping settings"](#), on page 213.

Parameters:

<AntPortMap> CB | RCB | FW
 CB = codebook
 RCB = random codebook
 FW = fixed weights
 *RST: CB

Example:

See [:SOURce<hw>] :BB:EUTRa:DL:USER<ch>:APM:CBCI on page 729

Options:

R&S SMM-K84

Manual operation: See "Antenna Port Mapping" on page 206

[:SOURce<hw>] :BB:EUTRa:DL[:SUBF<st0>]:ALLoc<ch0>[:CW<user>]:
 PRECoding:CBINdex[<dir>] <CodeBookIndex>

Sets the codebook index for the selected allocation.

The combination of codebook index and the selected number of layers determines the codebook matrix used for precoding.

Parameters:

<CodeBookIndex> integer
 Range: 0 to 15
 *RST: 0

Example:

```
SOURce1:BB:EUTRa:DL:SUBF0:ALLoc2:CW1:CONType PDSCh
SOURce1:BB:EUTRa:DL:SUBF0:ALLoc2:CW1:DATA PN16
SOURce1:BB:EUTRa:DL:SUBF0:ALLoc2:CW:PRECoding:SCHEME BF
SOURce1:BB:EUTRa:DL:SUBF0:ALLoc2:CW:PRECoding:TRScheme TM9
SOURce1:BB:EUTRa:DL:SUBF0:ALLoc2:CW:PRECoding:CBINdex2 0
```

Example:

See also [:SOURce<hw>] :BB:EUTRa:DL:USER<ch>:APM:CBCI on page 729

Manual operation: See "Codebook Index/Codebook Index 2" on page 207

[:SOURce<hw>] :BB:EUTRa:DL[:CELL<ccidx>]:SUBF<st0>]:ALLoc<ch0>:
 PUSCh:PRECoding:CBUA <CbUseAlt>

Applies the enhanced 4 Tx codebook.

Parameters:

<CbUseAlt> 1 | ON | 0 | OFF
 OFF
 The normal codebook is used.
 ON
 Applied is the enhanced 4Tx codebook.
 *RST: 0

Example: See `[:SOURce<hw>] :BB:EUTRa:DL:USER<ch>:APM:CBUA` on page 729.

Options: R&S SMM-K113

Manual operation: See ["Use Alternative Codebooks"](#) on page 206

`[:SOURce<hw>] :BB:EUTRa:DL[:SUBF<st0>]:ALLoc<ch0>[:CW<user>]:
PRECoding:CDD <CyclicDelayDiv>`

Sets the CDD for the selected allocation.

The combination of cyclic delay diversity and the selected number of layers determines the precoding parameters for spatial multiplexing.

Parameters:

<CyclicDelayDiv> NOCDd | SMDelay | LADelay

NOCDd

Zero CDD

SMDelay

Small CDD

LADelay

Large CDD

*RST: NOCDd

Example: `BB:EUTRa:DL:SUBF4:ALL5:CW:PREC:CDD SMD`
Selects small CDD

Manual operation: See ["Cyclic Delay Diversity"](#) on page 207

`[:SOURce<hw>] :BB:EUTRa:DL[:SUBF<st0>]:ALLoc<ch0>[:CW<user>]:
PRECoding:DAFormat <DataFormat>`

Switches between the Cartesian (Real/Imag.) and Cylindrical (Magn./Phase) coordinates representation.

Parameters:

<DataFormat> CARTesian | CYLindrical

*RST: CARTesian

Manual operation: See ["Mapping Coordinates"](#) on page 207

`[:SOURce<hw>] :BB:EUTRa:DL[:SUBF<st0>]:ALLoc<ch0>[:CW<user>]:
PRECoding:NOLayers <NoLayers>`

Sets the number of layers for the selected allocation.

Parameters:

<NoLayers> integer

Range: 1 to 8

*RST: 1

Example: BB:EUTRa:DL:SUBF4:ALL5:CW:PREC:NOL 2
Sets the number of layers to 2

Manual operation: See ["Number of Layers"](#) on page 205

**[:SOURCE<hw>]:BB:EUTRa:DL[:SUBF<st0>]:ALLoc<ch0>[:CW<user>]:
PRECoding:SCHEME <Scheme>**

(available for the first codeword only)

Selects the precoding scheme.

The available selections depend on the selected content type.

Parameters:

<Scheme> NONE | SPM | TXD | BF

NONE

Disables precoding.

SPM

Spatial multiplexing

TXD

Transmit diversity

BF

Sets the PDSCH to transmission mode selected with the command [\[:SOURCE<hw>\]:BB:EUTRa:DL\[:SUBF<st0>\]:ALLoc<ch0>\[:CW<user>\]:PRECoding:TRSCHEME](#).

*RST: NONE

Example: SOURCE1:BB:EUTRa:DL:SUBF4:ALLoc5:CONType PDSCh
SOURCE1:BB:EUTRa:DL:SUBF4:ALLoc5:CW1:PRECoding:
SCHEME SPM
Sets the precoding scheme to spatial multiplexing

Manual operation: See ["Precoding Scheme"](#) on page 204

**[:SOURCE<hw>]:BB:EUTRa:DL[:SUBF<st0>]:ALLoc<ch0>[:CW<user>]:
PRECoding:SCID <Scrambldentity>**

Sets the scrambling identity according to 36.211, sec. 6.10.3.1.

This value is used for initialization of the sequence used for generation of the UE-specific reference signals.

Parameters:

<Scrambldentity> integer

Range: 0 to 1

*RST: 0

Manual operation: See ["Scrambling Identity n_SCID"](#) on page 206

```
[:SOURce<hw>]:BB:EUTRa:DL[:SUBF<st0>]:ALLoc<ch0>[:CW<user>]:
  PRECoding:TRSCHEME <TransmissScheme>
```

Determines the transmission mode (see also [Table 2-6](#)).

Parameters:

```
<TransmissScheme> TM7 | TM8 | TM9 | TM10
*RST:             TM7
```

Options: TM7|TM8 require R&S SMM-K84
TM9 requires R&S SMM-K85

Manual operation: See "[Transmission Scheme](#)" on page 204

```
[:SOURce<hw>]:BB:EUTRa:DL[:SUBF<st0>]:ALLoc<ch0>[:CW<user>]:
  SCRambling:STATe <State>
```

Enables/disables the bit-level scrambling.

Parameters:

```
<State>           1 | ON | 0 | OFF
*RST:             ON
```

Example: SOUR:BB:EUTR:DL:SUBF0:ALL5:CW:DATA PN9
SOUR:BB:EUTR:DL:SUBF0:ALL5:CW:SCR:STAT ON
Enables scrambling

Example: If a "User 1..4" is selected for the Data Source for the corresponding allocation, this command is query only and the return value corresponds the state determined with the command [\[:SOURce<hw>\]:BB:EUTRa:DL:USER<ch>:SCRambling:STATe](#).

```
SOUR:BB:EUTR:DL:SUBF0:ALL4:CW:DATA USER3
SOUR:BB:EUTR:DL:USER3:SCR:STAT ON
SOUR:BB:EUTR:DL:SUBF0:ALL4:CW:SCR:STAT?
Response: On
```

Manual operation: See "[State Scrambling \(DL\)](#)" on page 209

```
[:SOURce<hw>]:BB:EUTRa:DL[:SUBF<st0>]:ALLoc<ch0>[:CW<user>]:
  SCRambling:UEID <Ueid>
```

Sets the user equipment identifier (n_RNTI) of the user to which the PDSCH transmission is intended. The UE ID is used to calculate the scrambling sequence.

Parameters:

```
<Ueid>           integer
Range:           0 to 65535
*RST:            0
```

Example: BB:EUTR:DL:SUBF0:ALL5:CW:UEID 120
Sets the user equipment identifier.

Manual operation: See "UE ID/n_RNTI (PDSCH)" on page 209

10.16 Enhanced PCFICH, PHICH and PDCCH configuration

[SOURce<hw>]:BB:EUTRa:DL[:SUBF<st0>]:ENCC:STATE.....	658
[SOURce<hw>]:BB:EUTRa:DL[:SUBF<st0>]:ENCC:SCRambling:STATE.....	658
[SOURce<hw>]:BB:EUTRa:DL[:SUBF<st0>]:ENCC:PRECoding:SCHeme.....	659
[SOURce<hw>]:BB:EUTRa:DL[:SUBF<st0>]:ENCC:PRECoding:NOLayers?.....	659
[SOURce<hw>]:BB:EUTRa:DL[:SUBF<st0>]:ENCC:PCFich:POWER.....	659
[SOURce<hw>]:BB:EUTRa:DL[:SUBF<st0>]:ENCC:PCFich:CREGion.....	660
[SOURce<hw>]:BB:EUTRa:DL[:SUBF<st0>]:ENCC:PHIch:PMODE.....	660
[SOURce<hw>]:BB:EUTRa:DL[:SUBF<st0>]:ENCC:PHIch:POWER.....	661
[SOURce<hw>]:BB:EUTRa:DL[:SUBF<st0>]:ENCC:PHIch[:CELL<ccidx>]:NOGRoups.....	661
[SOURce<hw>]:BB:EUTRa:DL[:SUBF<st0>]:ENCC:PHIch:CELL<ch0>:ANPattern<gr0>.....	661
[SOURce<hw>]:BB:EUTRa:DL[:SUBF<st0>]:ENCC:PHIch[:CELL<ccidx>]: GROup<gr0>:ITEM<user0>:POW.....	662
[SOURce<hw>]:BB:EUTRa:DL[:SUBF<st0>]:ENCC:PDCCh:POWER.....	662
[SOURce<hw>]:BB:EUTRa:DL[:SUBF<st0>]:ENCC:PDCCh:BITS.....	663
[SOURce<hw>]:BB:EUTRa:DL[:SUBF<st0>]:ENCC:PDCCh:AVRegs.....	663
[SOURce<hw>]:BB:EUTRa:DL[:SUBF<st0>]:ENCC:PDCCh:AVCCes.....	663
[SOURce<hw>]:BB:EUTRa:DL[:SUBF<st0>]:ENCC:PDCCh:FORMat.....	664
[SOURce<hw>]:BB:EUTRa:DL[:SUBF<st0>]:ENCC:PDCCh:NOPDcchs.....	664
[SOURce<hw>]:BB:EUTRa:DL[:SUBF<st0>]:ENCC:PDCCh:ALRegs.....	665
[SOURce<hw>]:BB:EUTRa:DL[:SUBF<st0>]:ENCC:PDCCh:DREGs.....	665
[SOURce<hw>]:BB:EUTRa:DL[:SUBF<st0>]:ENCC:PDCCh:DATA.....	665
[SOURce<hw>]:BB:EUTRa:DL[:SUBF<st0>]:ENCC:PDCCh:PATTern.....	666
[SOURce<hw>]:BB:EUTRa:DL[:SUBF<st0>]:ENCC:PDCCh:DSElect.....	666
[SOURce<hw>]:BB:EUTRa:DL[:SUBF<st0>]:ENCC:PDCCh:DCRegs:TRSource.....	666
[SOURce<hw>]:BB:EUTRa:DL[:SUBF<st0>]:ENCC:PDCCh:DCRegs:DATA.....	667
[SOURce<hw>]:BB:EUTRa:DL[:SUBF<st0>]:ENCC:PDCCh:DCRegs:DSElect.....	667
[SOURce<hw>]:BB:EUTRa:DL[:SUBF<st0>]:ENCC:PDCCh:DCRegs:PATTern.....	667
[SOURce<hw>]:BB:EUTRa:DL[:SUBF<st0>]:ENCC:PDCCh:EXTC:SITem.....	668
[SOURce<hw>]:BB:EUTRa:DL[:SUBF<st0>]:ENCC:PDCCh:EXTC:APPend.....	668
[SOURce<hw>]:BB:EUTRa:DL[:SUBF<st0>]:ENCC:PDCCh:EXTC:INSert.....	668
[SOURce<hw>]:BB:EUTRa:DL[:SUBF<st0>]:ENCC:PDCCh:EXTC:DELeTe.....	668
[SOURce<hw>]:BB:EUTRa:DL[:SUBF<st0>]:ENCC:PDCCh:EXTC:DOWN.....	669
[SOURce<hw>]:BB:EUTRa:DL[:SUBF<st0>]:ENCC:PDCCh:EXTC:UP.....	669
[SOURce<hw>]:BB:EUTRa:DL[:SUBF<st0>]:ENCC:PDCCh:EXTC:CONFLicts?.....	669
[SOURce<hw>]:BB:EUTRa:DL[:SUBF<st0>]:ENCC:PDCCh:EXTC:SOLVe?.....	670
[SOURce<hw>]:BB:EUTRa:DL[:SUBF<st0>]:ENCC:PDCCh:EXTC:RESet.....	670
[SOURce<hw>]:BB:EUTRa:DL[:SUBF<st0>]:ENCC:PDCCh:EXTC:UITems.....	670
[SOURce<hw>]:BB:EUTRa:DL[:SUBF<st0>]:ENCC:PDCCh:EXTC:ITEM<ch0>:DCIFmt.....	671
[SOURce<hw>]:BB:EUTRa:DL[:SUBF<st0>]:ENCC:PDCCh:EXTC:ITEM<ch0>:UEID.....	671
[SOURce<hw>]:BB:EUTRa:DL[:SUBF<st0>]:ENCC:PDCCh:EXTC:ITEM<ch0>:CELL.....	672
[SOURce<hw>]:BB:EUTRa:DL[:SUBF<st0>]:ENCC:PDCCh:EXTC:ITEM<ch0>:PFMT.....	672
[SOURce<hw>]:BB:EUTRa:DL[:SUBF<st0>]:ENCC:PDCCh:EXTC:ITEM<ch0>:NCCes?.....	672
[SOURce<hw>]:BB:EUTRa:DL[:SUBF<st0>]:ENCC:PDCCh:EXTC:ITEM<ch0>:CINDex.....	673

Enhanced PCFICH, PHICH and PDCCH configuration

[:SOURce<hw>]:BB:EUTRa:DL[:SUBF<st0>]:ENCC:PDCCh:EXTC:ITEM<ch0>: PDCChType.....	673
[:SOURce<hw>]:BB:EUTRa:DL[:SUBF<st0>]:ENCC:PDCCh:EXTC:ITEM<ch0>:NDCCes?...	673
[:SOURce<hw>]:BB:EUTRa:DL[:SUBF<st0>]:ENCC:PDCCh:EXTC:ITEM<ch0>:USER.....	674
[:SOURce<hw>]:BB:EUTRa:DL[:SUBF<st0>]:ENCC:PDCCh:EXTC:ITEM<ch0>:SESPace....	674
[:SOURce<hw>]:BB:EUTRa:DL[:SUBF<st0>]:ENCC:PDCCh:EXTC:ITEM<ch0>:CONFLICT?...	675
[:SOURce<hw>]:BB:EUTRa:DL[:SUBF<st0>]:ENCC:PDCCh:EXTC:ITEM<ch0>: DCIConf:APLayer.....	675
[:SOURce<hw>]:BB:EUTRa:DL[:SUBF<st0>]:ENCC:PDCCh:EXTC:ITEM<ch0>: DCIConf:BITData?.....	676
[:SOURce<hw>]:BB:EUTRa:DL[:SUBF<st0>]:ENCC:PDCCh:EXTC:ITEM<ch0>: DCIConf:CIField.....	676
[:SOURce<hw>]:BB:EUTRa:DL[:SUBF<st0>]:ENCC:PDCCh:EXTC:ITEM<ch0>: DCIConf:F1AMode.....	676
[:SOURce<hw>]:BB:EUTRa:DL[:SUBF<st0>]:ENCC:PDCCh:EXTC:ITEM<ch0>: DCIConf:PRACH:PRINdex.....	677
[:SOURce<hw>]:BB:EUTRa:DL[:SUBF<st0>]:ENCC:PDCCh:EXTC:ITEM<ch0>: DCIConf:PRACH:MINdex.....	677
[:SOURce<hw>]:BB:EUTRa:DL[:SUBF<st0>]:ENCC:PDCCh:EXTC:ITEM<ch0>: DCIConf:CSIRequest.....	678
[:SOURce<hw>]:BB:EUTRa:DL[:SUBF<st0>]:ENCC:PDCCh:EXTC:ITEM<ch0>: DCIConf:CSDMrs.....	678
[:SOURce<hw>]:BB:EUTRa:DL[:SUBF<st0>]:ENCC:PDCCh:EXTC:ITEM<ch0>: DCIConf:DLAindex.....	678
[:SOURce<hw>]:BB:EUTRa:DL[:SUBF<st0>]:ENCC:PDCCh:EXTC:ITEM<ch0>: DCIConf:DPOFset.....	679
[:SOURce<hw>]:BB:EUTRa:DL[:SUBF<st0>]:ENCC:PDCCh:EXTC:ITEM<ch0>: DCIConf:GAP.....	679
[:SOURce<hw>]:BB:EUTRa:DL[:SUBF<st0>]:ENCC:PDCCh:EXTC:ITEM<ch0>: DCIConf:HPN.....	679
[:SOURce<hw>]:BB:EUTRa:DL[:SUBF<st0>]:ENCC:PDCCh:EXTC:ITEM<ch0>: DCIConf:HACK.....	680
[:SOURce<hw>]:BB:EUTRa:DL[:SUBF<st0>]:ENCC:PDCCh:EXTC:ITEM<ch0>: DCIConf:MCSR.....	680
[:SOURce<hw>]:BB:EUTRa:DL[:SUBF<st0>]:ENCC:PDCCh:EXTC:ITEM<ch0>: DCIConf:NDI.....	681
[:SOURce<hw>]:BB:EUTRa:DL[:SUBF<st0>]:ENCC:PDCCh:EXTC:ITEM<ch0>: DCIConf:PDRE.....	681
[:SOURce<hw>]:BB:EUTRa:DL[:SUBF<st0>]:ENCC:PDCCh:EXTC:ITEM<ch0>: DCIConf:PFHopping.....	682
[:SOURce<hw>]:BB:EUTRa:DL[:SUBF<st0>]:ENCC:PDCCh:EXTC:ITEM<ch0>: DCIConf:PMI.....	682
[:SOURce<hw>]:BB:EUTRa:DL[:SUBF<st0>]:ENCC:PDCCh:EXTC:ITEM<ch0>: DCIConf:PREInfo.....	682
[:SOURce<hw>]:BB:EUTRa:DL[:SUBF<st0>]:ENCC:PDCCh:EXTC:ITEM<ch0>: DCIConf:RAH.....	683
[:SOURce<hw>]:BB:EUTRa:DL[:SUBF<st0>]:ENCC:PDCCh:EXTC:ITEM<ch0>: DCIConf:RAHR.....	683
[:SOURce<hw>]:BB:EUTRa:DL[:SUBF<st0>]:ENCC:PDCCh:EXTC:ITEM<ch0>: DCIConf:RAType.....	684

Enhanced PCFICH, PHICH and PDCCH configuration

[:SOURce<hw>]:BB:EUTRa:DL[:SUBF<st0>]:ENCC:PDCCh:EXTC:ITEM<ch0>: DCIConf:RBA.....	684
[:SOURce<hw>]:BB:EUTRa:DL[:SUBF<st0>]:ENCC:PDCCh:EXTC:ITEM<ch0>: DCIConf:RV.....	684
[:SOURce<hw>]:BB:EUTRa:DL[:SUBF<st0>]:ENCC:PDCCh:EXTC:ITEM<ch0>: DCIConf:SRSRequest.....	684
[:SOURce<hw>]:BB:EUTRa:DL[:SUBF<st0>]:ENCC:PDCCh:EXTC:ITEM<ch0>: DCIConf:SWAPflag.....	685
[:SOURce<hw>]:BB:EUTRa:DL[:SUBF<st0>]:ENCC:PDCCh:EXTC:ITEM<ch0>: DCIConf:TB1:MCS.....	685
[:SOURce<hw>]:BB:EUTRa:DL[:SUBF<st0>]:ENCC:PDCCh:EXTC:ITEM<ch0>: DCIConf:TB2:MCS.....	685
[:SOURce<hw>]:BB:EUTRa:DL[:SUBF<st0>]:ENCC:PDCCh:EXTC:ITEM<ch0>: DCIConf:TB1:NDI.....	685
[:SOURce<hw>]:BB:EUTRa:DL[:SUBF<st0>]:ENCC:PDCCh:EXTC:ITEM<ch0>: DCIConf:TB2:NDI.....	685
[:SOURce<hw>]:BB:EUTRa:DL[:SUBF<st0>]:ENCC:PDCCh:EXTC:ITEM<ch0>: DCIConf:TB1:RV.....	686
[:SOURce<hw>]:BB:EUTRa:DL[:SUBF<st0>]:ENCC:PDCCh:EXTC:ITEM<ch0>: DCIConf:TB2:RV.....	686
[:SOURce<hw>]:BB:EUTRa:DL[:SUBF<st0>]:ENCC:PDCCh:EXTC:ITEM<ch0>: DCIConf:SID.....	686
[:SOURce<hw>]:BB:EUTRa:DL[:SUBF<st0>]:ENCC:PDCCh:EXTC:ITEM<ch0>: DCIConf:TPCC.....	687
[:SOURce<hw>]:BB:EUTRa:DL[:SUBF<st0>]:ENCC:PDCCh:EXTC:ITEM<ch0>: DCIConf:TPCinstr.....	687
[:SOURce<hw>]:BB:EUTRa:DL[:SUBF<st0>]:ENCC:PDCCh:EXTC:ITEM<ch0>: DCIConf:TPMI.....	687
[:SOURce<hw>]:BB:EUTRa:DL[:SUBF<st0>]:ENCC:PDCCh:EXTC:ITEM<ch0>: DCIConf:ULIndex.....	688
[:SOURce<hw>]:BB:EUTRa:DL[:SUBF<st0>]:ENCC:PDCCh:EXTC:ITEM<ch0>: DCIConf:ULDLconf.....	688
[:SOURce<hw>]:BB:EUTRa:DL[:SUBF<st0>]:ENCC:PDCCh:EXTC:ITEM<ch0>: DCIConf:VRBA.....	689

[:SOURce<hw>]:BB:EUTRa:DL[:SUBF<st0>]:ENCC:STATe <State>

Enables/disables the PDCCH, PCFICH and PHICH allocation.

Parameters:

<State> 1 | ON | 0 | OFF
 *RST: ON

Example: BB:EUTR:DL:SUBF1:ENCC:STAT ON
 Enables PDCCH

Manual operation: See "State" on page 172

[:SOURce<hw>]:BB:EUTRa:DL[:SUBF<st0>]:ENCC:SCRambling:STATe <State>

Enables/disables the scrambling of the enhanced channels.

Enhanced PCFICH, PHICH and PDCCH configuration

Parameters:

<State> 1 | ON | 0 | OFF
 *RST: ON

Example:

SOURce1:BB:EUTRa:DL:SUBF1:ENCC:SCRambling:STATE
 ON

Manual operation: See "[Scrambling State](#)" on page 172

[:SOURce<hw>]:BB:EUTRa:DL[:SUBF<st0>]:ENCC:PRECoding:SCHEME
 <Scheme>

Selects the precoding scheme for PDCCH.

Parameters:

<Scheme> NONE | TXD
NONE
 Disables precoding.
TXD
 Precoding for transmit diversity will be performed according to 3GPP TS 36.211 and the selected parameters
 *RST: NONE

Example:

BB:EUTR:DL:SUBF1:ENCC:PREC:SCH TXD
 Selects the precoding scheme

Manual operation: See "[Precoding Scheme](#)" on page 172

[:SOURce<hw>]:BB:EUTRa:DL[:SUBF<st0>]:ENCC:PRECoding:NOLayers?

Queries the number of layers for PDCCH.

This value is fixed to 1 for PDCCH.

Return values:

<LayerCount> integer
 Range: 1 to 2
 *RST: 1

Example:

BB:EUTR:DL:SUBF1:ENCC:PREC:NOL?
 Queries the number of layers
 Response: 1

Usage: Query only

Manual operation: See "[Number of Layers \(Enhanced Channels\)](#)" on page 172

[:SOURce<hw>]:BB:EUTRa:DL[:SUBF<st0>]:ENCC:PCFich:POWER <Power>

Sets the power of the PCFICH (P_{PCFICH}).

Enhanced PCFICH, PHICH and PDCCH configuration

Parameters:

<Power> float
 Range: -80 to 10
 Increment: 0.001
 *RST: 0

Example:

BB:EUTR:DL:SUBF1:ENCC:PCF:POW -5
 Sets the power of the PCFICH to -5 dBm

Manual operation: See "[PCFICH Power](#)" on page 172

[:SOURCE<hw>]:BB:EUTRa:DL[:SUBF<st0>]:ENCC:PCFich:CREGion
 <ControlRegion>

Sets the number of OFDM Symbols to be used for PDCCH.

Parameters:

<ControlRegion> integer
 Range: 1 to 4
 *RST: 2

Example:

BB:EUTR:PHIC:DUR NORM
 Selects PHICH normal duration
 BB:EUTR:DL:SUBF1:ENCC:PCF:CREG 1
 Sets the control region

Manual operation: See "[Control Region for PDCCH \(PCell\)](#)" on page 172

[:SOURCE<hw>]:BB:EUTRa:DL[:SUBF<st0>]:ENCC:PHICH:PMODE <PowerMode>

Determines whether the PHICHs in a PHICH group are sent with the same power or enables the adjustment of each P_{PHICH} individually.

Parameters:

<PowerMode> CONST | IND
CONST
 The power of a PHICH in a PHICH group is set with the command SOUR:BB:EUTR:DL:ENCC:PHIC:POW.
IND
 The power of the individual PHICHs is set separately
 *RST: CONST

Example:

BB:EUTR:DL:SUBF1:ENCC:PHIC:PMOD CONS
 BB:EUTR:DL:SUBF1:ENCC:PHIC:POW -5
 // All PHICHs in the PHICH group are sent with this power

Manual operation: See "[Power Mode](#)" on page 174

[:SOURce<hw>]:BB:EUTRa:DL[:SUBF<st0>]:ENCC:PHICH:POWer <Power>

Sets the power of one PHICH (P_{PHICH}) in a PHICH group, i.e. the total power of one PHICH group is the sum of the power of the transmitted PHICHs within this group.

Parameters:

<Power> float
 Range: -80 to 10
 Increment: 0.001
 *RST: -3.010

Example:

```
SOUR:BB:EUTR:DL:SUBF2:ENCC:PHIC:PMOD CONS
SOUR:BB:EUTR:DL:SUBF2:ENCC:PHIC:NOGR 1
SOUR:BB:EUTR:DL:SUBF2:CYCP NORM
SOUR:BB:EUTR:DL:SUBF2:ENCC:PHIC:ANP1 '1---1---'
SOUR:BB:EUTR:DL:SUBF2:ENCC:PHIC:POW - 3
// Sets the power of one PHICHs in a PHICH group to -3 dB
```

Manual operation: See "[PHICH Power](#)" on page 175

[:SOURce<hw>]:BB:EUTRa:DL[:SUBF<st0>]:ENCC:PHICH[:CELL<ccidx>]:NOGRoups <GroupCount>

Queries the number of available PHICH groups.

Parameters:

<GroupCount> integer
 Range: 0 to dynamic
 *RST: 2

Example:

See `[:SOURce<hw>]:BB:EUTRa:DL[:SUBF<st0>]:ENCC:PHICH[:CELL<ccidx>]:GROup<gr0>:ITEM<user0>:POW` on page 662.

Options: CELL<ccidx> requires R&S SMM-K112

Manual operation: See "[Number of PHICH Groups](#)" on page 174

[:SOURce<hw>]:BB:EUTRa:DL[:SUBF<st0>]:ENCC:PHICH:CELL<ch0>:ANPattern<gr0> <AnPattern>

Sets the ACK/NACK pattern for the corresponding PHICH group.

Parameters:

<AnPattern> string
 String of 8 values
1
 Indicates an ACK
0
 Indicates a NACK

Enhanced PCFICH, PHICH and PDCCH configuration

-
Indicates DTX

Example: See `[:SOURCE<hw>] :BB:EUTRa:DL[:SUBF<st0>]:ENCC:PHICH[:CELL<ccidx>]:GROup<gr0>:ITEM<user0>:POW` on page 662.

Options: CELL<ch0> requires R&S SMM-K112

Manual operation: See "[ACK/NACK Pattern Group x](#)" on page 175

[:SOURCE<hw>] :BB:EUTRa:DL[:SUBF<st0>]:ENCC:PHICH[:CELL<ccidx>]:GROup<gr0>:ITEM<user0>:POW <Power>

Sets the power of the individual PHICHs.

Parameters:

<Power> float
Range: -80 to 10
Increment: 0.001
*RST: -3.010

Example:

```
SOURcel:BB:EUTRa:DL:CA:STATe 1
SOURcel:BB:EUTRa:DL:CA:CELL0:PHICH:NGParameter NG1
SOURcel:BB:EUTRa:DL:CA:CELL0:PHICH:DURation NORM

SOURcel:BB:EUTRa:DL:SUBF0:ENCC:PHICH:PMODE CONS
// sets the power mode
SOURcel:BB:EUTRa:DL:SUBF0:ENCC:PHICH:POWer -5
SOURcel:BB:EUTRa:DL:SUBF0:ENCC:PHICH:CELL0:NOGRoups?
// 7
SOURcel:BB:EUTRa:DL:SUBF0:ENCC:PHICH:CELL0:ANPattern0 0-1-11--
SOURcel:BB:EUTRa:DL:SUBF0:ENCC:PHICH:CELL0:GROup0:ITEM0:POW -5
SOURcel:BB:EUTRa:DL:SUBF0:ENCC:PHICH:CELL0:GROup0:ITEM2:POW -4
SOURcel:BB:EUTRa:DL:SUBF0:ENCC:PHICH:CELL0:GROup0:ITEM4:POW -6
SOURcel:BB:EUTRa:DL:SUBF0:ENCC:PHICH:CELL0:GROup0:ITEM5:POW 1
// sets the power of the PHICH#6 in the first PHICH group of the PCell
```

Options: CELL<ccidx> requires R&S SMM-K112

Manual operation: See "[Power Settings Config.](#)" on page 175

[:SOURCE<hw>] :BB:EUTRa:DL[:SUBF<st0>]:ENCC:PDCCh:POWer <Power>

Sets the power of the PDCCH (P_{PDCCH}).

The value set with this parameter is also displayed in the allocation table for the corresponding allocation.

Enhanced PCFICH, PHICH and PDCCH configuration

Parameters:

<Power> float
 Range: -80 to 10
 Increment: 0.001
 *RST: 0

Example:

BB:EUTR:DL:SUBF1:ENCC:PDCC:POW -5
 Sets the power of the PDCCH to -5dB

Manual operation: See "[Power](#)" on page 178

[[:SOURCE<hw>]:BB:EUTRa:DL[:SUBF<st0>]:ENCC:PDCCh:BITS <PhysBits>

Defines the number of bits allocated for PDCCH.

Parameters:

<PhysBits> integer
 Range: 0 to 1E5
 *RST: 0

Example:

BB:EUTR:DL:SUBF1:ENCC:STAT ON
 Enables PDCCH.
 BB:EUTR:DL:SUBF1:ENCC:PDCC:BITS?
 Queries the number of bits
 Response: 3144

Manual operation: See "[Number of PDCCH Bits / REGs / CCEs](#)" on page 178

**[[:SOURCE<hw>]:BB:EUTRa:DL[:SUBF<st0>]:ENCC:PDCCh:AVRegs
 <AvailRegionCoun>**

Defines the number of the REGs that are available for the PDCCH allocation.

Parameters:

<AvailRegionCoun> integer
 Range: 0 to 1E5
 *RST: 0

Example:

BB:EUTR:DL:SUBF1:ENCC:STAT ON
 Enables PDCCH.
 BB:EUTR:DL:SUBF1:ENCC:PDCC:AVR?
 Queries the number of REGs
 Response: 393

**[[:SOURCE<hw>]:BB:EUTRa:DL[:SUBF<st0>]:ENCC:PDCCh:AVCCes
 <AvailCceCount>**

Queries the number of the control channel elements (CCEs) that are available for the PDCCH allocation.

Enhanced PCFICH, PHICH and PDCCH configuration

Parameters:

<AvailCceCount> integer
 Range: 0 to 1E5
 *RST: 0

Example:

BB:EUTR:DL:SUBF1:ENCC:STAT ON
 Enables PDCCH.
 BB:EUTR:DL:SUBF1:ENCC:PDCC:AVCC?
 Queries the number of CCEs
 Response 43

Manual operation: See "[Number of PDCCH Bits / REGs / CCEs](#)" on page 178

[:SOURCE<hw>]:BB:EUTRa:DL[:SUBF<st0>]:ENCC:PDCCh:FORMat <Format>

Sets the PDCCH format.

Parameters:

<Format> VAR | -1 | 0 | 1 | 2 | 3

VAR

Enables full flexibility by the configuration of the downlink control information (DCI) format and content.

-1

Proprietary format for legacy support.

0 | 1 | 2 | 3

One PDCCH is transmitted on one, two, four or eight CCEs

*RST: VAR

Example:

BB:EUTR:DL:SUBF2:ENCC:PDCC:FORM 0
 Sets the PDCCH format.

Manual operation: See "[PDCCH Format](#)" on page 177

**[:SOURCE<hw>]:BB:EUTRa:DL[:SUBF<st0>]:ENCC:PDCCh:NOPDcchs
 <PdcchCount>**

Sets the number of PDCCHs to be transmitted.

Parameters:

<PdcchCount> integer
 Range: 0 to dynamic
 *RST: 0

Example:

BB:EUTR:DL:SUBF2:ENCC:PDCC:FORM 0
 Sets the PDCCH format.
 BB:EUTR:DL:SUBF2:ENCC:PDCC:NOPD 20
 Sets the number of PDCCHs.

Manual operation: See "[Number of PDCCHs](#)" on page 179

[:SOURce<hw>]:BB:EUTRa:DL[:SUBF<st0>]:ENCC:PDCCh:ALRegs
 <AllocRegionCoun>

Defines the number of REGs that are actually allocated for PDCCH transmission (#REGs allocated_{PDCCH}).

Parameters:

<AllocRegionCoun> integer
 Range: 0 to 1E5
 *RST: 0

Example:

BB:EUTR:DL:SUBF2:ENCC:PDCC:FORM 0
 Sets the PDCCH format.
 BB:EUTR:DL:SUBF2:ENCC:PDCC:NOPD 20
 Sets the number of PDCCHs.
 BB:EUTR:DL:SUBF2:ENCC:PDCC:ALR?
 Queries the number of REGs
 Response: 180

Manual operation: See "[Number of REGs allocated to PDCCH](#)" on page 179

[:SOURce<hw>]:BB:EUTRa:DL[:SUBF<st0>]:ENCC:PDCCh:DREGs
 <DummyRegsCount>

Defines the number of REGs that are available for the PDCCH allocation but are not allocated.

Parameters:

<DummyRegsCount> integer
 Range: 0 to 1E5
 Increment: 1
 *RST: 0

Example:

BB:EUTR:DL:SUBF2:ENCC:PDCC:FORM 0
 Sets the PDCCH format.
 BB:EUTR:DL:SUBF2:ENCC:PDCC:NOPD 20
 Sets the number of PDCCHs.
 BB:EUTR:DL:SUBF2:ENCC:PDCC:ALR?
 Queries the number of REGs
 Response: 180
 BB:EUTR:DL:SUBF2:ENCC:PDCC:DREG?
 Queries the number of dummy REGs
 Response: 213

Manual operation: See "[Number of Dummy REGs](#)" on page 180

[:SOURce<hw>]:BB:EUTRa:DL[:SUBF<st0>]:ENCC:PDCCh:DATA <Data>

Selects the data source for PDCCH.

Enhanced PCFICH, PHICH and PDCCH configuration

Parameters:

<Data> PN9 | PN11 | PN15 | PN16 | PN20 | PN21 | PN23 | PATtern |
DLIST | ZERO | ONE
*RST: PN9

Example:

```
BB:EUTR:DL:SUBF2:ENCC:PDCC:FORM 0
Sets the PDCCH format.
BB:EUTR:DL:SUBF1:ENCC:PDCC:DATA PN9
PN9 is selected as data source
```

Manual operation: See "[Data Source](#)" on page 180

[:SOURCE<hw>]:BB:EUTRa:DL[:SUBF<st0>]:ENCC:PDCC:h:PATtern <Pattern>, <BitCount>

Selects the bit pattern for the `PATT` selection.

Parameters:

<Pattern> numeric
*RST: #H0

<BitCount> integer
Range: 1 to 64
*RST: 1

Example:

```
BB:EUTR:DL:SUBF2:ENCC:PDCC:FORM 0
BB:EUTR:DL:SUBF1:ENCC:PDCC:DATA PATT
BB:EUTR:DL:SUBF1:ENCC:PDCC:PATT #H3F,8
```

Manual operation: See "[Data Source](#)" on page 180

[:SOURCE<hw>]:BB:EUTRa:DL[:SUBF<st0>]:ENCC:PDCC:h:DSElect <Filename>

Selects an existing data list file from the default directory or from the specific directory.

Parameters:

<Filename> string
Filename incl. file extension or complete file path

Example:

```
SOURCE1:BB:EUTRa:DL:SUBF1:ENCC:PDCC:h:FORMat 0
SOURCE1:BB:EUTRa:DL:SUBF1:ENCC:PDCC:h:DATA DLIST
SOURCE1:BB:EUTRa:DL:SUBF1:ENCC:PDCC:h:DSElect "/var/user/temp/pdcch"
```

[:SOURCE<hw>]:BB:EUTRa:DL[:SUBF<st0>]:ENCC:PDCC:h:DCRegs:TRSource <TranSource>

Sets the behavior of the dummy REGs, i.e. determines whether dummy data or DTX is transmitted.

Parameters:

<TranSource> DATA | DTX
*RST: DATA

Example: BB:EUTR:DL:SUBF1:ENCC:PDCC:FORM VAR
BB:EUTR:DL:SUBF1:ENCC:PDCC:DCR:TRS DATA

Manual operation: See ["Dummy CCE REGs"](#) on page 181

[:SOURCE<hw>]:BB:EUTRa:DL[:SUBF<st0>]:ENCC:PDCC:DCRegs:DATA
<Data>

Selects the data source for PDCCH.

Parameters:
<Data> PN9 | PN11 | PN15 | PN16 | PN20 | PN21 | PN23 | PATtern |
DLISt | ZERO | ONE
*RST: PN9

Example: BB:EUTR:DL:SUBF1:ENCC:PDCC:FORM VAR
Sets the PDCCH format.
BB:EUTR:DL:SUBF1:ENCC:PDCC:DCR:DATA PN9
PN9 is selected as data source

Manual operation: See ["Dummy CCE Data Source"](#) on page 182

[:SOURCE<hw>]:BB:EUTRa:DL[:SUBF<st0>]:ENCC:PDCC:DCRegs:DSElect
<Filename>

Selects an existing data list file from the default directory or from the specific directory.

Parameters:
<Filename> string
Filename incl. file extension or complete file path

Example: SOURCE1:BB:EUTRa:DL:SUBF1:ENCC:PDCC:FORMat VAR
SOURCE1:BB:EUTRa:DL:SUBF1:ENCC:PDCC:DCRegs:DATA DLISt
SOURCE1:BB:EUTRa:DL:SUBF1:ENCC:PDCC:DCRegs:DSElect "/var/user/temp/pdch

Manual operation: See ["Dummy CCE Data Source"](#) on page 182

[:SOURCE<hw>]:BB:EUTRa:DL[:SUBF<st0>]:ENCC:PDCC:DCRegs:PATTern
<Pattern>, <BitCount>

Selects the bit pattern for the PATT selection.

Parameters:
<Pattern> numeric
*RST: #H0
<BitCount> integer
Range: 1 to 64
*RST: 1

Enhanced PCFICH, PHICH and PDCCH configuration

Example:
 BB:EUTR:DL:SUBF1:ENCC:PDCC:FORM VAR
 BB:EUTR:DL:SUBF1:ENCC:PDCC:DCR:DATA PATT
 BB:EUTR:DL:SUBF1:ENCC:PDCC:DCR:PATT #H3F,8

Manual operation: See ["Dummy CCE Data Source"](#) on page 182

[:SOURCE<hw>]:BB:EUTRa:DL[:SUBF<st0>]:ENCC:PDCC:EXTC:SITem
 <SelectedItem>

Selects an PDCCH item, i.e. a row in the DCI table.

Parameters:

<SelectedItem> integer
 Range: 0 to 39
 *RST: 0

Example:
 BB:EUTR:DL:SUBF1:ENCC:PDCC:FORM VAR
 Sets the PDCCH format.
 BB:EUTR:DL:SUBF1:ENCC:PDCC:EXTC:SIT 2
 Selects the third row in the DCI table

Manual operation: See ["Standard configuration functions"](#) on page 182

[:SOURCE<hw>]:BB:EUTRa:DL[:SUBF<st0>]:ENCC:PDCC:EXTC:APPend

Adds a new row at the end of the DCI table.

Example:
 BB:EUTR:DL:SUBF1:ENCC:PDCC:FORM VAR
 Sets the PDCCH format.
 BB:EUTR:DL:SUBF1:ENCC:PDCC:EXTC:APP
 Adds a new row

Manual operation: See ["Standard configuration functions"](#) on page 182

[:SOURCE<hw>]:BB:EUTRa:DL[:SUBF<st0>]:ENCC:PDCC:EXTC:INSert

Insert a new row before the currently selected item.

Example:
 BB:EUTR:DL:SUBF1:ENCC:PDCC:FORM VAR
 Sets the PDCCH format.
 BB:EUTR:DL:SUBF1:ENCC:PDCC:EXTC:SIT 2
 Selects the third row in the DCI table
 BB:EUTR:DL:SUBF1:ENCC:PDCC:EXTC:INS
 Inserts a new row before the third one

Manual operation: See ["Standard configuration functions"](#) on page 182

[:SOURCE<hw>]:BB:EUTRa:DL[:SUBF<st0>]:ENCC:PDCC:EXTC:DELeTe

Deletes the selected row.

Example: BB:EUTR:DL:SUBF1:ENCC:PDCC:FORM VAR
Sets the PDCCH format.
BB:EUTR:DL:SUBF1:ENCC:PDCC:EXTC:SIT 2
Selects the third row in the DCI table
BB:EUTR:DL:SUBF1:ENCC:PDCC:EXTC:DEL
Deletes the third row

Usage: Event

Manual operation: See "[Standard configuration functions](#)" on page 182

[:SOURce<hw>]:BB:EUTRa:DL[:SUBF<st0>]:ENCC:PDCC:EXTC:DOWN
[:SOURce<hw>]:BB:EUTRa:DL[:SUBF<st0>]:ENCC:PDCC:EXTC:UP

Moves the selected row down or up.

Example: BB:EUTR:DL:SUBF1:ENCC:PDCC:FORM VAR
Sets the PDCCH format.
BB:EUTR:DL:SUBF1:ENCC:PDCC:EXTC:SIT 2
Selects the third row in the DCI table
BB:EUTR:DL:SUBF1:ENCC:PDCC:EXTC:UP
Moves the third row one row up

Manual operation: See "[Standard configuration functions](#)" on page 182

[:SOURce<hw>]:BB:EUTRa:DL[:SUBF<st0>]:ENCC:PDCC:EXTC:CONFLICTS?

Queries the number of conflicts between the DCI formats.

To query whether there is a conflict in one particular PDCCH item, use the command
[\[:SOURce<hw>\]:BB:EUTRa:DL\[:SUBF<st0>\]:ENCC:PDCC:EXTC:ITEM<ch0>:CONFLICT?](#) on page 675.

Return values:

<NoOfConf>	integer
Range:	0 to 20
*RST:	0

Enhanced PCFICH, PHICH and PDCCH configuration

Example: SOURCE1:BB:EUTRa:DL:SUBF1:ENCC:PDCCh:FORMat
 VARiable
 SOURCE1:BB:EUTRa:DL:SUBF1:ENCC:PDCCh:EXTC:
 CONFLicts?
Response: 1
 SOURCE1:BB:EUTRa:DL:SUBF1:ENCC:PDCCh:EXTC:
 UITems?
Response: 2
 SOURCE1:BB:EUTRa:DL:SUBF1:ENCC:PDCCh:EXTC:
 ITEM0:CONFLict?
Response: 0
 SOURCE1:BB:EUTRa:DL:SUBF1:ENCC:PDCCh:EXTC:
 ITEM1:CONFLict?
Response: 1
 The DCI conflict is in the second PDCCH item
 SOURCE1:BB:EUTRa:DL:SUBF1:ENCC:PDCCh:EXTC:SOLVe

Usage: Query only

Manual operation: See ["Resolve Conflicts"](#) on page 183
 See ["Conflict \(DCI\)"](#) on page 189

[:SOURCE<hw>]:BB:EUTRa:DL[:SUBF<st0>]:ENCC:PDCCh:EXTC:SOLVe?

Triggers a built-in algorithm that re-assigns automatically the CCE values depending on the configured "Search Space"; previously configured CCE values will not be maintained.

If the conflict cannot be resolved automatically, the values are left unchanged.

Example: :SOURCE:BB:EUTRa:DL:SUBF1:ENCC:PDCCh:EXTC:SOLVe

Usage: Query only

Manual operation: See ["Resolve Conflicts"](#) on page 183

[:SOURCE<hw>]:BB:EUTRa:DL[:SUBF<st0>]:ENCC:PDCCh:EXTC:RESet

Resets the table.

Example: BB:EUTRa:DL:SUBF1:ENCC:PDCC:FORM VAR
 Sets the PDCCH format.
 BB:EUTRa:DL:SUBF1:ENCC:PDCC:EXTC:RES
 Resets the table

Manual operation: See ["Reset"](#) on page 183

**[:SOURCE<hw>]:BB:EUTRa:DL[:SUBF<st0>]:ENCC:PDCCh:EXTC:UITems
 <UsedItems>**

Queries the number of used PDCCH items.

Enhanced PCFICH, PHICH and PDCCH configuration

Parameters:

<UsedItems> integer
 Range: 0 to 20
 *RST: 0

Example:

SOURce1:BB:EUTRa:DL:SUBF1:ENCC:PDCCh:FORMat
 VARiable
 SOURce1:BB:EUTRa:DL:SUBF1:ENCC:PDCCh:EXTC:
 APPend
 SOURce1:BB:EUTRa:DL:SUBF1:ENCC:PDCCh:EXTC:
 UITems?
 Response: 2

Manual operation: See ["Number of Used \(E\)PDCCH Items"](#) on page 184

**[:SOURce<hw>]:BB:EUTRa:DL[:SUBF<st0>]:ENCC:PDCCh:EXTC:ITEM<ch0>:
 DCIFmt <DciFormat>**

Sets the DCI format for the selected PDCCH.

Parameters:

<DciFormat> F0 | F1 | F1A | F1B | F1C | F1D | F2 | F2A | F3 | F3A | F2B |
 F2C | F2D
 *RST: F0

Example:

SOURce1:BB:EUTRa:DL:SUBF1:ENCC:PDCCh:FORMat
 VARiable
 SOURce1:BB:EUTRa:DL:SUBF1:ENCC:PDCCh:EXTC:
 ITEM1:DCIFmt F1

Manual operation: See ["DCI Format"](#) on page 186

**[:SOURce<hw>]:BB:EUTRa:DL[:SUBF<st0>]:ENCC:PDCCh:EXTC:ITEM<ch0>:
 UEID <Ueid>**

Sets the n_RNTI for the selected PDCCH.

Parameters:

<Ueid> integer
 Range: 0 to 100000
 *RST: 0

Example:

BB:EUTRa:DL:SUBF1:ENCC:PDCC:FORM VAR
 Sets the PDCCH format.
 BB:EUTRa:DL:SUBF1:ENCC:PDCC:EXTC:ITEM1:UEID 100
 Sets the n_RNTI

Manual operation: See ["UE_ID/n_RNTI"](#) on page 185

**[:SOURce<hw>]:BB:EUTRa:DL[:SUBF<st0>]:ENCC:PDCC:EXTC:ITEM<ch0>:
CELL <CellIdx>**

Determines the component carrier the corresponding DCI is transmitted on.

Parameters:

<CellIdx> integer
Range: 0 to 7
*RST: 0

Options: R&S SMM-K85

Manual operation: See "[Cell Index](#)" on page 185

**[:SOURce<hw>]:BB:EUTRa:DL[:SUBF<st0>]:ENCC:PDCC:EXTC:ITEM<ch0>:
PFMT <Format>**

Sets the PDCCH format for the selected PDCCH.

Parameters:

<Format> integer
Range: 0 to 3
*RST: 0

Example:

BB:EUTR:DL:SUBF1:ENCC:PDCC:FORM VAR
Sets PDCCH format variable.
BB:EUTR:DL:SUBF1:ENCC:PDCC:EXTC:ITEM1:PFMT 0
Sets the PDCCH format.

Manual operation: See "[\(E\)PDCCH Format \(Variable\)](#)" on page 188

**[:SOURce<hw>]:BB:EUTRa:DL[:SUBF<st0>]:ENCC:PDCC:EXTC:ITEM<ch0>:
NCCes?**

Queries the number of control channel elements used for the transmission of the PDCCH.

Return values:

<CceCount> integer
Range: 0 to 1E5
*RST: 1

Example:

BB:EUTR:DL:SUBF1:ENCC:PDCC:FORM VAR
Sets the PDCCH format.
BB:EUTR:DL:SUBF1:ENCC:PDCC:EXTC:ITEM1:NCC?
Queries the number of CCEs

Usage: Query only

Manual operation: See "[Number \(E\)CCEs](#)" on page 189

```
[ :SOURce<hw>]:BB:EUTRa:DL[:SUBF<st0>]:ENCC:PDCCh:EXTC:ITEM<ch0>:
  CINDEX <CcelIndex>
```

Sets the CCE start index.

Parameters:

```
<CcelIndex>      integer
                  Range:    0 to 1E5
                  *RST:     0
```

Example:

```
SOURce1:BB:EUTRa:DL:SUBF1:ENCC:PDCCh:FORMat VAR
Sets the PDCCH format.
SOURce1:BB:EUTRa:DL:SUBF1:ENCC:PDCCh:EXTC:
ITEM1:CINDEX 10
Sets the CCE start index
```

Manual operation: See "(E)CCE Index" on page 189

```
[ :SOURce<hw>]:BB:EUTRa:DL[:SUBF<st0>]:ENCC:PDCCh:EXTC:ITEM<ch0>:
  PDCChType <PdcchType>
```

Sets if the DCI is carried by a PDCCH or by an EPDCCH set.

Parameters:

```
<PdcchType>      PDCCh | EPD1 | EPD2
                  EPD1|EPD2
                  EPDCCH sets cannot be allocated TDD special subframes, if
                  the combinations listed in Table 4-6 apply.
                  *RST:    PDCCh
```

Example:

```
SOURce1:BB:EUTRa:DL:SUBF0:ENCC:PDCCh:EXTC:
ITEM1:PDCChType?
See Example "Configuring EPDCCH transmission" on page 739
See also [ :SOURce<hw>]:BB:EUTRa:DL[:SUBF<st0>]:
ENCC:PDCCh:EXTC:ITEM<ch0>:DCIConf:HACK
on page 680.
```

Options: R&S SMM-K112

Manual operation: See "(E)PDCCH" on page 186

```
[ :SOURce<hw>]:BB:EUTRa:DL[:SUBF<st0>]:ENCC:PDCCh:EXTC:ITEM<ch0>:
  NDCCes?
```

Queries the number of dummy CCEs that are appended to the PDCCH.

Return values:

```
<DummyCceCount> integer
                  Range:    0 to 1E5
                  *RST:     25
```

- Example:** BB:EUTR:DL:SUBF1:ENCC:PDCC:FORM VAR
Sets the PDCCH format.
BB:EUTR:DL:SUBF1:ENCC:PDCC:EXTC:ITEM1:NDCC?
Queries the number of dummy CCEs
- Usage:** Query only
- Manual operation:** See "[No. Dummy \(E\)CCEs](#)" on page 189

**[[:SOURce<hw>]:BB:EUTRa:DL[:SUBF<st0>]:ENCC:PDCC:EXTC:ITEM<ch0>]:
USER <User>**

Selects the User the DCI is dedicated to.

The available DCI Formats depend on the value of this parameter.

Parameters:

<User> USER1 | USER2 | USER3 | USER4 | PRNTi | SIRNti | RARNti |
NONE | U1E | U2E | U3E | UE4 | CCNRti
*RST: USER1

Return values:

<User> USER1 | USER2 | USER3 | USER4 | PRNTi | SIRNti | RARNti |
NONE | U1SPs | U2SPs | U3SPs | U4SPs | U1E | U2E | U3E |
UE4 | CCNRti
Range: USER1 to NONE
*RST: USER1

Example: SOURce1:BB:EUTRa:DL:SUBF1:ENCC:PDCC:EXTC:
ITEM1:USER USER2
The DCI is dedicated to User 2

Options: U1E|U2E|U3E|UE4 require R&S SMM-K113
CCNRti requires R&S SMM-K119

Manual operation: See "[User](#)" on page 184

**[[:SOURce<hw>]:BB:EUTRa:DL[:SUBF<st0>]:ENCC:PDCC:EXTC:ITEM<ch0>]:
SESPace <SearchSpace>**

If enabled, this parameter configures the PDCCH DCI to be transmitted within the common or UE-specific search space.

Parameters:

<SearchSpace> OFF | AUTO | COMMON | UE | ON | 0 | 1
COMMON|UE
Common and UE-specific search spaces, as defined in the 3GPP specification
OFF|AUTO
For backwards compatibility only.
*RST: AUTO

Example: BB:EUTRa:DL:SUBF1:ENCC:PDCCh:EXTC:ITEM1:SESP UE
The DCI is transmitted within the UE-specific search space.

Manual operation: See "Search Space" on page 187

**[:SOURCE<hw>]:BB:EUTRa:DL[:SUBF<st0>]:ENCC:PDCCh:EXTC:ITEM<ch0>:
CONFLICT?**

Indicates a conflict between two DCI formats.

Return values:

<Conflict> 1 | ON | 0 | OFF
*RST: OFF

Example: SOURCE1:BB:EUTRa:DL:SUBF1:ENCC:PDCCh:EXTC:
ITEM1:CONFLICT?
queries whether there is a conflict or not.

Usage: Query only

Manual operation: See "Conflict (DCI)" on page 189

**[:SOURCE<hw>]:BB:EUTRa:DL[:SUBF<st0>]:ENCC:PDCCh:EXTC:ITEM<ch0>:
DCIConf:APLayer <ApLayerId>**

Sets the DCI Format 2C field antenna port(s), layer, scrambling Id.

Option:R&S SMM-K119:

Table 10-1: Value range <ApLayerId>

[:SOURCE<hw>]:BB:EUTRa:DL: USER<ch>:CELL<st0>:DMRS: STATE	[:SOURCE<hw>]:BB:EUTRa:DL: USER<ch>:CELL<st0>:SEOL: STATE	1 codeword	2 codewords
0	0	0 to 6	0 to 7
1	0	0 to 11	0 to 14
1	1	0 to 1	0 to 1

Parameters:

<ApLayerId> integer
Range: 0 to 7
*RST: 0

Example: SOURCE1:BB:EUTRa:DL:USER1:TXM M9
SOURCE1:BB:EUTRa:DL:SUBF1:ENCC:PDCCh:FORMAt
VARiable
SOURCE1:BB:EUTRa:DL:SUBF1:ENCC:PDCCh:EXTC:
ITEM1:DCIFmt F2C
SOURCE1:BB:EUTRa:DL:SUBF1:ENCC:PDCCh:EXTC:
ITEM1:DCIConf:APLayer 2

Options: <ApLayerId> = 8 to 14 require R&S SMM-K119

**[:SOURCE<hw>]:BB:EUTRa:DL[:SUBF<st0>]:ENCC:PDCCh:EXTC:ITEM<ch0>:
DCIConf:BITData?**

Queries the resulting bit data as selected with the DCI format parameters.

Return values:

<BitData> string

Example:

```
BB:EUTR:DL:SUBF1:ENCC:PDCC:FORM VAR
Sets the PDCCH format.
BB:EUTR:DL:SUBF1:ENCC:PDCC:EXTC:ITEM1:DCIC:
BITD?
Queries the bit data
```

Usage: Query only

Manual operation: See "[Bit Data](#)" on page 190

**[:SOURCE<hw>]:BB:EUTRa:DL[:SUBF<st0>]:ENCC:PDCCh:EXTC:ITEM<ch0>:
DCIConf:CIField <CalndField>**

The CIF is present in **each** DCI Format and identifies the component carrier that carries the PDSCH or PUSCH for the particular PDCCH in the cross-carrier approach (see [Figure 2-27](#)).

Parameters:

<CalndField> integer
Range: 0 to 7
*RST: 0

Example:

```
BB:EUTR:DL:CA:STAT ON
BB:EUTR:DL:USER2:CA:STAT ON
BB:EUTR:DL:CA:CELL0:CIF ON
BB:EUTR:DL:ENCC:PDCC:EXTC:ITEM1:DCIC:CIF 1
```

Options: R&S SMM-K85

Manual operation: See "[Carrier Indicator Field \(CIF\)](#)" on page 185

**[:SOURCE<hw>]:BB:EUTRa:DL[:SUBF<st0>]:ENCC:PDCCh:EXTC:ITEM<ch0>:
DCIConf:F1AMode <Format1aMode>**

Selects the mode of the DCI format.

Parameters:

<Format1aMode> PDSCh | PRACH
*RST: PDSCh

Enhanced PCFICH, PHICH and PDCCH configuration

Example: BB:EUTR:DL:SUBF1:ENCC:PDCC:FORM VAR
Sets the PDCCH format.
BB:EUTR:DL:SUBF1:ENCC:PDCC:EXTC:ITEM1:DCIF F1A
Sets the DCI format
BB:EUTR:DL:SUBF1:ENCC:PDCC:EXTC:ITEM1:DCIC:F1AM
PRAC
Sets the mode

**[:SOURCE<hw>]:BB:EUTRa:DL[:SUBF<st0>]:ENCC:PDCC:EXTC:ITEM<ch0>:
DCIConf:PRACH:PRINdex <PreambleIndex>**

(PRACH mode only)

Sets the DCI Format 1A field Preamble index.

Parameters:

<PreambleIndex> integer
Range: 0 to 63
*RST: 0

Example: BB:EUTR:DL:SUBF1:ENCC:PDCC:FORM VAR
Sets the PDCCH format.
BB:EUTR:DL:SUBF1:ENCC:PDCC:EXTC:ITEM1:DCIF F1A
Sets the DCI format
BB:EUTR:DL:SUBF1:ENCC:PDCC:EXTC:ITEM1:F1AM PRAC
Sets the mode
BB:EUTR:DL:SUBF1:ENCC:PDCC:EXTC:ITEM1:DCIC:
PRAC:PRIN 10
Sets the preamble index

**[:SOURCE<hw>]:BB:EUTRa:DL[:SUBF<st0>]:ENCC:PDCC:EXTC:ITEM<ch0>:
DCIConf:PRACH:MINdex <MaskIndex>**

(PRACH mode only)

Sets the DCI Format 1A field PRACH Mask Index.

Parameters:

<MaskIndex> integer
Range: 0 to 15
*RST: 0

Example: BB:EUTR:DL:SUBF1:ENCC:PDCC:FORM VAR
Sets the PDCCH format.
BB:EUTR:DL:SUBF1:ENCC:PDCC:EXTC:ITEM1:DCIF F1A
Sets the DCI format
BB:EUTR:DL:SUBF1:ENCC:PDCC:EXTC:ITEM1:F1AM PRAC
Sets the mode
BB:EUTR:DL:SUBF1:ENCC:PDCC:EXTC:ITEM1:DCIC:
PRAC:MIND 10
Sets the preamble index

**[:SOURce<hw>]:BB:EUTRa:DL[:SUBF<st0>]:ENCC:PDCC:EXTC:ITEM<ch0>:
DCIConf:CSIRequest <CsiRequest>**

Sets the DCI Format 0 field CSI/CQI Request.

Parameters:

<CsiRequest> integer
 Range: 0 to 1 (with carrier aggregation 0 to 3)
 *RST: 0

Example:

```
BB:EUTR:DL:SUBF1:ENCC:PDCC:FORM VAR
BB:EUTR:DL:SUBF1:ENCC:PDCC:EXTC:ITEM1:DCIF F0
BB:EUTR:DL:SUBF1:ENCC:PDCC:EXTC:ITEM1:DCIC:CSIR
1
```

**[:SOURce<hw>]:BB:EUTRa:DL[:SUBF<st0>]:ENCC:PDCC:EXTC:ITEM<ch0>:
DCIConf:CSDMrs <CyclicShftDmRs>**

Sets the DCI Format 0 field cyclic shift for DMRS.

Parameters:

<CyclicShftDmRs> integer
 Range: 0 to 7
 *RST: 0

Example:

```
BB:EUTR:DL:SUBF1:ENCC:PDCC:FORM VAR
Sets the PDCCH format.
BB:EUTR:DL:SUBF1:ENCC:PDCC:EXTC:ITEM1:DCIF F0
Sets the DCI format
BB:EUTR:DL:SUBF1:ENCC:PDCC:EXTC:ITEM1:DCIC:CSDM
1
Sets the cyclic shift
```

**[:SOURce<hw>]:BB:EUTRa:DL[:SUBF<st0>]:ENCC:PDCC:EXTC:ITEM<ch0>:
DCIConf:DLAindex <DIAssignIndex>**

(Enabled for TDD mode only)

Sets the DCI Format 0/1A/1B/1D/2/2A field downlink assignment index.

Parameters:

<DIAssignIndex> integer
 Range: 0 to 3
 *RST: 0

Enhanced PCFICH, PHICH and PDCCH configuration

Example: BB:EUTR:DUPL TDD
Selects TDD mode.
BB:EUTR:DL:SUBF1:ENCC:PDCC:FORM VAR
Sets the PDCCH format.
BB:EUTR:DL:SUBF1:ENCC:PDCC:EXTC:ITEM1:DCIF F0
Sets the DCI format
BB:EUTR:DL:SUBF1:ENCC:PDCC:EXTC:ITEM1:DCIC:DLA
1
Sets the downlink assignment index

**[:SOURCE<hw>]:BB:EUTRa:DL[:SUBF<st0>]:ENCC:PDCC:EXTC:ITEM<ch0>:
DCIConf:DPOffset <DpOffset>**

Sets the DCI Format 1D field downlink power offset.

Parameters:
<DpOffset> 1 | ON | 0 | OFF
*RST: OFF

Example: BB:EUTR:DL:SUBF1:ENCC:PDCC:FORM VAR
Sets the PDCCH format.
BB:EUTR:DL:SUBF1:ENCC:PDCC:EXTC:ITEM1:DCIF F1D
Sets the DCI format
BB:EUTR:DL:SUBF1:ENCC:PDCC:EXTC:ITEM1:DCIC:DPOF
ON
Enables downlink power offset

**[:SOURCE<hw>]:BB:EUTRa:DL[:SUBF<st0>]:ENCC:PDCC:EXTC:ITEM<ch0>:
DCIConf:GAP <Gap>**

Sets the DCI Format 1A/1B/1C/1D field GAP value.

Parameters:
<Gap> ON | OFF
*RST: OFF

Example: BB:EUTR:DL:SUBF1:ENCC:PDCC:FORM VAR
Sets the PDCCH format.
BB:EUTR:DL:SUBF1:ENCC:PDCC:EXTC:ITEM1:DCIF F1C
Sets the DCI format
BB:EUTR:DL:SUBF1:ENCC:PDCC:EXTC:ITEM1:DCIC:GAP
ON
Enables gap value

**[:SOURCE<hw>]:BB:EUTRa:DL[:SUBF<st0>]:ENCC:PDCC:EXTC:ITEM<ch0>:
DCIConf:HPN <HarqProcessNumb>**

Sets the DCI Format 1/1A/1B/1D/2/2A field HARQ process number.

Parameters:`<HarqProcessNum>` integer

Range: 0 to 15

*RST: 0

Example:`BB:EUTR:DL:SUBF1:ENCC:PDCC:FORM VAR`

Sets the PDCCH format.

`BB:EUTR:DL:SUBF1:ENCC:PDCC:EXTC:ITEM1:DCIF F1B`

Sets the DCI format

`BB:EUTR:DL:SUBF1:ENCC:PDCC:EXTC:ITEM1:DCIC:HPN
5`

Sets the HARQ process number

**`[:SOURce<hw>]:BB:EUTRa:DL[:SUBF<st0>]:ENCC:PDCC:EXTC:ITEM<ch0>:
DCIConf:HACK <HarqAck>`**

Sets the DCI Format 2C/2D field HARQ-ACK resource offset.

Parameters:`<HarqAck>` integer

Range: 0 to 3

*RST: 0

Example:`SCONfiguration:APPLY``SCONfiguration:MODE ADV``SCONfiguration:FADing MIMO4X4``SCONfiguration:BASEband:SOURce COUP``SCONfiguration:APPLY``SOURce1:BB:EUTRa:DL:USER1:CELL0:TXM M10``SOURce1:BB:EUTRa:DL:SUBF0:ENCC:PDCC:EXTC:SITeM 0``SOURce1:BB:EUTRa:DL:SUBF0:ENCC:PDCC:EXTC:ITEM0:PDCChtype EPD1``SOURce1:BB:EUTRa:DL:SUBF0:ENCC:PDCC:EXTC:ITEM0:DCIFmt F2D``SOURce1:BB:EUTRa:DL:SUBF0:ENCC:PDCC:EXTC:ITEM0:DCIConf:PDRE 0``SOURce1:BB:EUTRa:DL:USER1:EPDCch1:STAT 1``SOURce1:BB:EUTRa:DL:SUBF0:ENCC:PDCC:EXTC:ITEM0:DCIConf:HACK 1`**Options:**

R&S SMM-K112

**`[:SOURce<hw>]:BB:EUTRa:DL[:SUBF<st0>]:ENCC:PDCC:EXTC:ITEM<ch0>:
DCIConf:MCSR <Mcsr>`**

Sets the DCI formats 1/1B/1D/2/2A/2B/2C/2D field modulation and coding scheme.

Enhanced PCFICH, PHICH and PDCCH configuration

Parameters:

<Mcsr> integer
 Range: 0 to depends on the installed options
 *RST: 0
 Option:R&S SMM-K55
 max = 31
 Option:R&S SMM-K119
 max = 63
 Values 32 to 63 available if [:SOURCE<hw>]:BB:EUTRa:DL:USER<ch>:CELL<st0>:MCS T4.

Example:

```
BB:EUTR:DL:SUBF1:ENCC:PDCC:FORM VAR
BB:EUTR:DL:SUBF1:ENCC:PDCC:EXTC:ITEM1:DCIF F1B
BB:EUTR:DL:SUBF1:ENCC:PDCC:EXTC:ITEM1:DCIC:MCSR
5
```

Options:

Values 32 to 63 require R&S SMM-K119

**[:SOURCE<hw>]:BB:EUTRa:DL[:SUBF<st0>]:ENCC:PDCC:EXTC:ITEM<ch0>:
 DCIConf:NDI <NewDataIndicat>**

Sets the DCI Format 0/1/1A/1B/1D field New Data Indicator.

Parameters:

<NewDataIndicat> ON | OFF
 *RST: OFF

Example:

```
BB:EUTR:DL:SUBF1:ENCC:PDCC:FORM VAR
Sets the PDCCH format.
BB:EUTR:DL:SUBF1:ENCC:PDCC:EXTC:ITEM1:DCIF F1B
Sets the DCI format
BB:EUTR:DL:SUBF1:ENCC:PDCC:EXTC:ITEM1:DCIC:NDI
ON
Sets the New Data Indicator
```

**[:SOURCE<hw>]:BB:EUTRa:DL[:SUBF<st0>]:ENCC:PDCC:EXTC:ITEM<ch0>:
 DCIConf:PDRE <PdschRe>**

Sets the DCI Format 2D field PDSCH RE mapping and QCL indicator.

Parameters:

<PdschRe> integer
 Range: 0 to 3
 *RST: 0

Enhanced PCFICH, PHICH and PDCCH configuration

Example:

```

SCONfiguration:APPLY
SCONfiguration:MODE ADV
SCONfiguration:FADing MIMO4X4
SCONfiguration:BASEband:SOURce COUP
SCONfiguration:APPLY

SOURce1:BB:EUTRa:DL:USER1:CELL0:TXM M10
SOURce1:BB:EUTRa:DL:SUBF0:ENCC:PDCCh:EXTC:SITem 0
SOURce1:BB:EUTRa:DL:SUBF0:ENCC:PDCCh:EXTC:ITEM0:DCIFmt F2D
SOURce1:BB:EUTRa:DL:SUBF0:ENCC:PDCCh:EXTC:ITEM0:DCIConf:PDRE 0

```

Options: R&S SMM-K112

**[:SOURce<hw>]:BB:EUTRa:DL[:SUBF<st0>]:ENCC:PDCCh:EXTC:ITEM<ch0>:
DCIConf:PFHopping <FreqHopState>**

Sets the DCI Format 0 field PUSCH Frequency Hopping.

Parameters:

<FreqHopState> 1 | ON | 0 | OFF
*RST: OFF

Example:

```

BB:EUTR:DL:SUBF1:ENCC:PDCC:FORM VAR
Sets the PDCCH format.
BB:EUTR:DL:SUBF1:ENCC:PDCC:EXTC:ITEM1:DCIF F0
Sets the DCI format
BB:EUTR:DL:SUBF1:ENCC:PDCC:EXTC:ITEM1:DCIC:PFH
ON
Enables PUSCH Frequency Hopping

```

**[:SOURce<hw>]:BB:EUTRa:DL[:SUBF<st0>]:ENCC:PDCCh:EXTC:ITEM<ch0>:
DCIConf:PMI <PmiState>**

Sets the DCI Format 1B field PMI Confirmation for Precoding.

Parameters:

<PmiState> 1 | ON | 0 | OFF
*RST: OFF

Example:

```

BB:EUTR:DL:SUBF1:ENCC:PDCC:FORM VAR
BB:EUTR:DL:SUBF1:ENCC:PDCC:EXTC:ITEM1:DCIF F1B
BB:EUTR:DL:SUBF1:ENCC:PDCC:EXTC:ITEM1:DCIC:PMI
ON

```

**[:SOURce<hw>]:BB:EUTRa:DL[:SUBF<st0>]:ENCC:PDCCh:EXTC:ITEM<ch0>:
DCIConf:PREInfo <PrecodingInfo>**

Sets the DCI Format 2/2A field Precoding Information.

Enhanced PCFICH, PHICH and PDCCH configuration

Parameters:

<PrecodingInfo> integer
 Range: 0 to 63
 *RST: 0

Example:

BB:EUTR:DL:SUBF1:ENCC:PDCC:FORM VAR
 Sets the PDCCH format.
 BB:EUTR:DL:SUBF1:ENCC:PDCC:EXTC:ITEM1:DCIF F2
 Sets the DCI format
 BB:EUTR:DL:SUBF1:ENCC:PDCC:EXTC:ITEM1:DCIC:PREC
 10
 Sets Precoding Information

**[:SOURce<hw>]:BB:EUTRa:DL[:SUBF<st0>]:ENCC:PDCC:EXTC:ITEM<ch0>:
 DCIConf:RAH <ResAllocHeader>**

(Enabled for Channel Bandwidth > 10RBs)

Sets the DCI Format 1/2/2A field Resource Allocation Header.

Parameters:

<ResAllocHeader> 1 | ON | 0 | OFF
 *RST: OFF

Example:

BB:EUTR:DL:SUBF1:ENCC:PDCC:FORM VAR
 BB:EUTR:DL:SUBF1:ENCC:PDCC:EXTC:ITEM1:DCIF F2
 BB:EUTR:DL:SUBF1:ENCC:PDCC:EXTC:ITEM1:DCIC:RAH
 ON

**[:SOURce<hw>]:BB:EUTRa:DL[:SUBF<st0>]:ENCC:PDCC:EXTC:ITEM<ch0>:
 DCIConf:RAHR <Rahr>**

Sets the DCI Format 0 field Resource Block Assignment and Hopping Resource Allocation.

Parameters:

<Rahr> integer
 Range: 0 to dynamic
 *RST: 0

Example:

BB:EUTR:DL:SUBF1:ENCC:PDCC:FORM VAR
 Sets the PDCCH format.
 BB:EUTR:DL:SUBF1:ENCC:PDCC:EXTC:ITEM1:DCIF F0
 Sets the DCI format
 BB:EUTR:DL:SUBF1:ENCC:PDCC:EXTC:ITEM1:DCIC:RAHR
 100
 Sets Resource Block Assignment and Hopping Resource Allocation

**[:SOURce<hw>]:BB:EUTRa:DL[:SUBF<st0>]:ENCC:PDCC:EXTC:ITEM<ch0>:
DCIConf:RAType <ResAllocType>**

Sets the DCI Format 0 field Resource Allocation Type.

Parameters:

<ResAllocType> integer
Range: 0 to 1
*RST: 0

**[:SOURce<hw>]:BB:EUTRa:DL[:SUBF<st0>]:ENCC:PDCC:EXTC:ITEM<ch0>:
DCIConf:RBA <ResBlockAssign>**

Sets the DCI Format 0/1/1A/1B/1C/1D/2/2A field Resource Block Assignment.

Parameters:

<ResBlockAssign> integer
Range: 0 to 268435455
*RST: 0

Example:

```
BB:EUTR:DL:SUBF1:ENCC:PDCC:FORM VAR
Sets the PDCCH format.
BB:EUTR:DL:SUBF1:ENCC:PDCC:EXTC:ITEM1:DCIF F0
Sets the DCI format
BB:EUTR:DL:SUBF1:ENCC:PDCC:EXTC:ITEM1:DCIC:RBA
100
Sets Resource Block Assignment
```

**[:SOURce<hw>]:BB:EUTRa:DL[:SUBF<st0>]:ENCC:PDCC:EXTC:ITEM<ch0>:
DCIConf:RV <RedundVersion>**

Sets the DCI Format 1/1A/1B/1D field Redundancy Version.

Parameters:

<RedundVersion> integer
Range: 0 to 3
*RST: 0

Example:

```
BB:EUTR:DL:SUBF1:ENCC:PDCC:FORM VAR
Sets the PDCCH format.
BB:EUTR:DL:SUBF1:ENCC:PDCC:EXTC:ITEM1:DCIF F1
Sets the DCI format
BB:EUTR:DL:SUBF1:ENCC:PDCC:EXTC:ITEM1:DCIC:RV 1
Sets the Redundancy Version
```

**[:SOURce<hw>]:BB:EUTRa:DL[:SUBF<st0>]:ENCC:PDCC:EXTC:ITEM<ch0>:
DCIConf:SRSRequest <SrsRequest>**

Sets the SRS Request filed.

Enhanced PCFICH, PHICH and PDCCH configuration

Parameters:

<SrsRequest> integer
 Range: 0 to 1
 *RST: 0

**[:SOURce<hw>]:BB:EUTRa:DL[:SUBF<st0>]:ENCC:PDCCh:EXTC:ITEM<ch0>:
 DCIConf:SWAPflag <SwapFlag>**

Sets the DCI Format 2/2A field Transport Block to Codeword Swap Flag.

Parameters:

<SwapFlag> ON | OFF
 *RST: OFF

Example:

BB:EUTR:DL:SUBF1:ENCC:PDCC:FORM VAR
 Sets the PDCCH format.
 BB:EUTR:DL:SUBF1:ENCC:PDCC:EXTC:ITEM1:DCIF F1
 Sets the DCI format
 BB:EUTR:DL:SUBF1:ENCC:PDCC:EXTC:ITEM1:DCIC:SWAP
 ON
 Enables Transport Block to Codeword Swap Flag

**[:SOURce<hw>]:BB:EUTRa:DL[:SUBF<st0>]:ENCC:PDCCh:EXTC:ITEM<ch0>:
 DCIConf:TB1:MCS <Mcs>**
**[:SOURce<hw>]:BB:EUTRa:DL[:SUBF<st0>]:ENCC:PDCCh:EXTC:ITEM<ch0>:
 DCIConf:TB2:MCS <Mcs>**

Sets the DCI Format 2/2A field Modulation and Coding Scheme.

Parameters:

<Mcs> integer
 Range: 0 to 31
 *RST: 0

Example:

BB:EUTR:DL:SUBF1:ENCC:PDCC:FORM VAR
 Sets the PDCCH format.
 BB:EUTR:DL:SUBF1:ENCC:PDCC:EXTC:ITEM1:DCIF F2
 Sets the DCI format
 BB:EUTR:DL:SUBF1:ENCC:PDCC:EXTC:ITEM1:DCIC:TB1:
 MCS 5
 Sets the Modulation and Coding Scheme for TB1

**[:SOURce<hw>]:BB:EUTRa:DL[:SUBF<st0>]:ENCC:PDCCh:EXTC:ITEM<ch0>:
 DCIConf:TB1:NDI <NewDataIndicat>**
**[:SOURce<hw>]:BB:EUTRa:DL[:SUBF<st0>]:ENCC:PDCCh:EXTC:ITEM<ch0>:
 DCIConf:TB2:NDI <NewDataIndicat>**

Sets the DCI Format 2/2A field New Data Indicator.

Parameters:

<NewDataIndicat> ON | OFF
 *RST: OFF

Example:

BB:EUTR:DL:SUBF1:ENCC:PDCC:FORM VAR
 Sets the PDCCH format.
 BB:EUTR:DL:SUBF1:ENCC:PDCC:EXTC:ITEM1:DCIF F2
 Sets the DCI format
 BB:EUTR:DL:SUBF1:ENCC:PDCC:EXTC:ITEM1:DCIC:TB2:
 NDI ON
 Sets the New Data Indicator for TB2

**[:SOURCE<hw>]:BB:EUTRa:DL[:SUBF<st0>]:ENCC:PDCC:EXTC:ITEM<ch0>:
 DCIConf:TB1:RV <RedundVersion>**
**[:SOURCE<hw>]:BB:EUTRa:DL[:SUBF<st0>]:ENCC:PDCC:EXTC:ITEM<ch0>:
 DCIConf:TB2:RV <RedundVersion>**

Sets the DCI Format 2/2A field Redundancy Version.

Parameters:

<RedundVersion> integer
 Range: 0 to 3
 *RST: 0

Example:

BB:EUTR:DL:SUBF1:ENCC:PDCC:FORM VAR
 Sets the PDCCH format.
 BB:EUTR:DL:SUBF1:ENCC:PDCC:EXTC:ITEM1:DCIF F2
 Sets the DCI format
 BB:EUTR:DL:SUBF1:ENCC:PDCC:EXTC:ITEM1:DCIC:TB1:
 RV 1
 Sets the Redundancy Version for TB1

**[:SOURCE<hw>]:BB:EUTRa:DL[:SUBF<st0>]:ENCC:PDCC:EXTC:ITEM<ch0>:
 DCIConf:SID <ScramIdent>**

Enables/disables the DCI Format 2B field Scrambling Identity.

Parameters:

<ScramIdent> 1 | ON | 0 | OFF
 *RST: OFF

Example:

BB:EUTR:DL:SUBF1:ENCC:PDCC:FORM VAR
 Sets the PDCCH format.
 BB:EUTR:DL:SUBF1:ENCC:PDCC:EXTC:ITEM1:DCIF F2B
 Sets the DCI format
 BB:EUTR:DL:SUBF1:ENCC:PDCC:EXTC:ITEM1:DCIC:SID
 ON
 Enables the Scrambling Identity

```
[:SOURCE<hw>]:BB:EUTRa:DL[:SUBF<st0>]:ENCC:PDCC:EXTC:ITEM<ch0>:
DCIConf:TPCC <TpcCommand>
```

Sets the DCI Format 0/1/1A/1B/1D/2/2A field TPC Command for PUSCH.

Parameters:

```
<TpcCommand>      integer
                   Range:    0 to 3
                   *RST:    0
```

Example:

```
BB:EUTR:DL:SUBF1:ENCC:PDCC:FORM VAR
Sets the PDCCH format.
BB:EUTR:DL:SUBF1:ENCC:PDCC:EXTC:ITEM1:DCIF F1B
Sets the DCI format
BB:EUTR:DL:SUBF1:ENCC:PDCC:EXTC:ITEM1:DCIC:TPCC
1
Sets the TPC Command for PUSCH
```

```
[:SOURCE<hw>]:BB:EUTRa:DL[:SUBF<st0>]:ENCC:PDCC:EXTC:ITEM<ch0>:
DCIConf:TPCinstr <TpcCommand>
```

Sets the DCI Format 3/3A field TPC Command.

Parameters:

```
<TpcCommand>      bit pattern
                   The bit pattern length depends on the selected channel band-
                   width and is automatically adjusted
```

Example:

```
BB:EUTR:DL:SUBF1:ENCC:PDCC:FORM VAR
Sets the PDCCH format.
BB:EUTR:DL:SUBF1:ENCC:PDCC:EXTC:ITEM1:DCIF F3
Sets the DCI format
BB:EUTR:DL:SUBF1:ENCC:PDCC:EXTC:ITEM1:DCIC:TPC
#B101,3
Sets the TPC Command
```

Manual operation: See "[DCI Format 3/3A](#)" on page 201

```
[:SOURCE<hw>]:BB:EUTRa:DL[:SUBF<st0>]:ENCC:PDCC:EXTC:ITEM<ch0>:
DCIConf:TPMI <Tpmi>
```

Sets the DCI Format 1B/1D field TPMI Information for Precoding.

Parameters:

```
<Tpmi>            integer
                   Range:    0 to 15
                   *RST:    0
```

Enhanced PCFICH, PHICH and PDCCH configuration

Example: BB:EUTR:DL:SUBF1:ENCC:PDCC:FORM VAR
Sets the PDCCH format.
BB:EUTR:DL:SUBF1:ENCC:PDCC:EXTC:ITEM1:DCIF F1B
Sets the DCI format
BB:EUTR:DL:SUBF1:ENCC:PDCC:EXTC:ITEM1:DCIC:TPMI
10
Sets the TPMI Information for Precoding

**[:SOURCE<hw>]:BB:EUTRa:DL[:SUBF<st0>]:ENCC:PDCC:EXTC:ITEM<ch0>:
DCIConf:ULIndex <ULIndex>**

(Enabled for TDD mode and UL/DL Configuration 0)

Sets the DCI Format 1B/1D field UL Index.

Parameters:

<ULIndex> integer
Range: 0 to 3
*RST: 0

Example: BB:EUTR:DUPL TDD
Selects TDD mode.
BB:EUTR:TDD:UDC 0
Sets the UL/DL configuration
BB:EUTR:DL:SUBF1:ENCC:PDCC:FORM VAR
Sets the PDCCH format.
BB:EUTR:DL:SUBF1:ENCC:PDCC:EXTC:ITEM1:DCIF F1B
Sets the DCI format
BB:EUTR:DL:SUBF1:ENCC:PDCC:EXTC:ITEM1:DCIC:ULIN
1
Sets the UL Index

**[:SOURCE<hw>]:BB:EUTRa:DL[:SUBF<st0>]:ENCC:PDCC:EXTC:ITEM<ch0>:
DCIConf:ULDLconf <DciUIDIConf>**

Sets the UL/DL configuration numbers.

Each UL/DL configuration number consists of 3 bits and indicates one of the configurations listed in [Figure 2-5](#).

Parameters:

<DciUIDIConf> 64 bits

Example:

```
SOURce1:BB:EUTRa:DUPLexing TDD
SOURce1:BB:EUTRa:LINK DOWN

SOURce1:BB:EUTRa:DL:SUBF0:ENCC:PDCCh:EXTC:ITEM0:USER U1E
SOURce1:BB:EUTRa:DL:SUBF0:ENCC:PDCCh:EXTC:ITEM0:SESPace AUTO
SOURce1:BB:EUTRa:DL:SUBF0:ENCC:PDCCh:EXTC:ITEM0:DCIFmt?
// F1C
SOURce1:BB:EUTRa:DL:SUBF0:ENCC:PDCCh:EXTC:ITEM1:DCIConf:ULDL #H3AF,12
SOURce1:BB:EUTRa:DL:SUBF0:ENCC:PDCCh:EXTC:ITEM0:PFMT 2
SOURce1:BB:EUTRa:DL:SUBF0:ENCC:PDCCh:EXTC:ITEM0:CINdex 0
```

Options: R&S SMM-K113

Manual operation: See ["DCI Format 1C for eIMTA"](#) on page 196

**[:SOURce<hw>]:BB:EUTRa:DL[:SUBF<st0>]:ENCC:PDCCh:EXTC:ITEM<ch0>:
DCIConf:VRBA <VrbAssignState>**

Sets the DCI Format 1A/1B/1D field Localized/Distributed VRB Assignment.

Parameters:

<VrbAssignState> ON | OFF
*RST: OFF

Example:

```
BB:EUTR:DL:SUBF1:ENCC:PDCC:FORM VAR
Sets the PDCCH format.
BB:EUTR:DL:SUBF1:ENCC:PDCC:EXTC:ITEM1:DCIF F1B
Sets the DCI format
BB:EUTR:DL:SUBF1:ENCC:PDCC:EXTC:ITEM1:DCIC:VRBA
ON
Enables the Localized VRB Assignment
```

10.17 Auto sequence

Option: R&S SMM-K112

Example: How to enable and configure the auto sequence mode

```
SOURce1:BB:EUTRa:DL:CONF:MODE ASEQ
SOURce1:BB:EUTRa:DL:CA:CELL0:CIF 1
SOURce1:BB:EUTRa:DL:CA:CELL1:CIF 1
SOURce1:BB:EUTRa:DL:USER1:CELL0:TXM M10
SOURce1:BB:EUTRa:DL:USER1:CELL1:TXM M9
SOURce1:BB:EUTRa:DL:USER2:CELL0:TXM M7
SOURce1:BB:EUTRa:DL:USER2:CELL1:TXM M7

SOURce1:BB:EUTRa:DL:SUBF0:ENCC:PDCCh:EXTC:ITEM1:DCIFmt F2D

SOURce1:BB:EUTRa:DL:USER1:STATe 1
SOURce1:BB:EUTRa:DL:USER2:STATe 1
```

```

SOURCE1:BB:EUTRa:DL:USER1:AS:DL:AFSeq 1
SOURCE1:BB:EUTRa:DL:USER1:AS:DL:NHIDs 8
SOURCE1:BB:EUTRa:DL:USER1:AS:DL:NHTRans 4
SOURCE1:BB:EUTRa:DL:USER1:AS:DL:INDI 1
SOURCE1:BB:EUTRa:DL:USER1:AS:DL:SKPProcess 1
SOURCE1:BB:EUTRa:DL:USER1:AS:DL:USUBframe0 1
SOURCE1:BB:EUTRa:DL:USER1:AS:DL:USUBframe1 1
SOURCE1:BB:EUTRa:DL:USER1:AS:UL:AFSeq 1
SOURCE1:BB:EUTRa:DL:USER1:AS:UL:NHTRans 4
SOURCE1:BB:EUTRa:DL:USER1:AS:UL:INDI 1
SOURCE1:BB:EUTRa:DL:USER1:AS:APPLY
SOURCE1:BB:EUTRa:DL:USER1:AS:ARBLen?
// 32
SOURCE1:BB:EUTRa:DL:USER1:AS:ASLength

SOURCE1:BB:EUTRa:DL:USER1:AS:DL:CELL0:SLENgth?
// 320
SOURCE1:BB:EUTRa:DL:USER1:AS:DL:CELL0:MCSMode FIX
SOURCE1:BB:EUTRa:DL:USER1:AS:DL:CELL0:FMCS 30
SOURCE1:BB:EUTRa:DL:USER1:AS:DL:CELL0:RVCSequence "0,1,2,3"
SOURCE1:BB:EUTRa:DL:USER1:AS:DL:CELL0:SEQelem0:SUBFrame?
// 0
SOURCE1:BB:EUTRa:DL:USER1:AS:DL:CELL0:SEQelem0:HARQ?
// 0
SOURCE1:BB:EUTRa:DL:USER1:AS:DL:CELL0:SEQelem0:TB1:NDI?
// 1
SOURCE1:BB:EUTRa:DL:USER1:AS:DL:CELL0:SEQelem1:TB1:NDI?
// 1
SOURCE1:BB:EUTRa:DL:USER1:AS:DL:CELL0:SEQelem0:TB1:RV?
// 0
SOURCE1:BB:EUTRa:DL:USER1:AS:DL:CELL0:URLCounter?
// 0

SOURCE1:BB:EUTRa:DL:USER1:AS:DL:CELL0:SEQelem0:PDRE?
// 0

SOURCE1:BB:EUTRa:DL:USER1:AS:UL:CELL0:SLENgth?
// 320
SOURCE1:BB:EUTRa:DL:USER1:AS:UL:CELL0:VULTxpow 1
SOURCE1:BB:EUTRa:DL:USER1:AS:UL:CELL0:SEQelem2:SUBFrame?
// 2
SOURCE1:BB:EUTRa:DL:USER1:AS:UL:CELL0:SEQelem2:RBA?
// 0
SOURCE1:BB:EUTRa:DL:USER1:AS:UL:CELL0:SEQelem2:NDI?
// 1
SOURCE1:BB:EUTRa:DL:USER1:AS:UL:CELL0:SEQelem2:PTPC 2
SOURCE1:BB:EUTRa:DL:USER1:AS:UL:CELL0:SEQelem2:CONFLICT?
// 0

SOURCE1:BB:EUTRa:DL:USER1:AS:DL:CELL1:MCSMode TCR
SOURCE1:BB:EUTRa:DL:USER1:AS:DL:CELL1:TCR 0.333

```

SOURce1:BB:EUTRa:DL:USER1:AS:DL:CELL1:TMOD QAM64

SOURce1:BB:EUTRa:DL:USER1:AS:DL:CELL1:SElement 2

[SOURce<hw>]:BB:EUTRa:DL:USER<ch>:AS:ARBLen?	692
[SOURce<hw>]:BB:EUTRa:DL:USER<ch>:AS:ASLength	692
[SOURce<hw>]:BB:EUTRa:DL:USER<ch>:AS:DL:AFSeq	692
[SOURce<hw>]:BB:EUTRa:DL:USER<ch>:AS:UL:AFSeq	692
[SOURce<hw>]:BB:EUTRa:DL:USER<ch>:AS:DL:NHIDs	692
[SOURce<hw>]:BB:EUTRa:DL:USER<ch>:AS:DL:NHTRans	693
[SOURce<hw>]:BB:EUTRa:DL:USER<ch>:AS:UL:NHTRans	693
[SOURce<hw>]:BB:EUTRa:DL:USER<ch>:AS:DL:SKPRocess	693
[SOURce<hw>]:BB:EUTRa:DL:USER<ch>:AS:DL:INDI	693
[SOURce<hw>]:BB:EUTRa:DL:USER<ch>:AS:UL:INDI	693
[SOURce<hw>]:BB:EUTRa:DL:USER<ch>:AS:DL[:CELL<ccidx>]:USUBframe<dir0>	694
[SOURce<hw>]:BB:EUTRa:DL:USER<ch>:AS:APPLY	694
[SOURce<hw>]:BB:EUTRa:DL:USER<ch>:AS:DL:CELL<st0>:MCSMode	694
[SOURce<hw>]:BB:EUTRa:DL:USER<ch>:AS:DL:CELL<st0>:FMCS	694
[SOURce<hw>]:BB:EUTRa:DL:USER<ch>:AS:DL:CELL<st0>:TCR	695
[SOURce<hw>]:BB:EUTRa:DL:USER<ch>:AS:DL:CELL<st0>:TMOD	695
[SOURce<hw>]:BB:EUTRa:DL:USER<ch>:AS:DL:CELL<st0>:RVCSequence	695
[SOURce<hw>]:BB:EUTRa:DL:USER<ch>:AS:DL:CELL<st0>:SEQelem<dir0>:HARQ	695
[SOURce<hw>]:BB:EUTRa:DL:USER<ch>:AS:DL:CELL<st0>:SEQelem<dir0>:PDRE	696
[SOURce<hw>]:BB:EUTRa:DL:USER<ch>:AS:DL:CELL<st0>:SLENgth?	696
[SOURce<hw>]:BB:EUTRa:DL:USER<ch>:AS:UL:CELL<st0>:SLENgth?	696
[SOURce<hw>]:BB:EUTRa:DL:USER<ch>:AS:DL:CELL<st0>:SEQelem<dir0>:SUBFrame..	697
[SOURce<hw>]:BB:EUTRa:DL:USER<ch>:AS:UL:CELL<st0>:SEQelem<dir0>:SUBFrame..	697
[SOURce<hw>]:BB:EUTRa:DL:USER<ch>:AS:DL:CELL<st0>:SEQelem<dir0>:TB1:MCS....	697
[SOURce<hw>]:BB:EUTRa:DL:USER<ch>:AS:DL:CELL<st0>:SEQelem<dir0>:TB2:MCS....	697
[SOURce<hw>]:BB:EUTRa:DL:USER<ch>:AS:DL:CELL<st0>:SEQelem<dir0>:TB1:NDI....	697
[SOURce<hw>]:BB:EUTRa:DL:USER<ch>:AS:DL:CELL<st0>:SEQelem<dir0>:TB2:NDI....	697
[SOURce<hw>]:BB:EUTRa:DL:USER<ch>:AS:UL:CELL<st0>:SEQelem<dir0>:NDI....	697
[SOURce<hw>]:BB:EUTRa:DL:USER<ch>:AS:DL:CELL<st0>:SEQelem<dir0>:TB1: RLCCounter.....	698
[SOURce<hw>]:BB:EUTRa:DL:USER<ch>:AS:DL:CELL<st0>:SEQelem<dir0>:TB2: RLCCounter.....	698
[SOURce<hw>]:BB:EUTRa:DL:USER<ch>:AS:DL:CELL<st0>:SEQelem<dir0>:TB1:RV.....	698
[SOURce<hw>]:BB:EUTRa:DL:USER<ch>:AS:DL:CELL<st0>:SEQelem<dir0>:TB2:RV.....	698
[SOURce<hw>]:BB:EUTRa:DL:USER<ch>:AS:DL:CELL<st0>:SEQelem<dir0>:CONFLict?...	698
[SOURce<hw>]:BB:EUTRa:DL:USER<ch>:AS:UL:CELL<st0>:SEQelem<dir0>:CONFLict?...	698
[SOURce<hw>]:BB:EUTRa:DL:USER<ch>:AS:DL:CELL<st0>:URLCounter.....	698
[SOURce<hw>]:BB:EUTRa:DL:USER<ch>:AS:UL:CELL<st0>:SEQelem<dir0>:RBA.....	699
[SOURce<hw>]:BB:EUTRa:DL:USER<ch>:AS:UL:CELL<st0>:SEQelem<dir0>:PTPC.....	699
[SOURce<hw>]:BB:EUTRa:DL:USER<ch>:AS:UL:CELL<st0>:SEQelem<dir0>:ULINdex.....	699
[SOURce<hw>]:BB:EUTRa:DL:USER<ch>:AS:UL:CELL<st0>:VULTxpow.....	700
[SOURce<hw>]:BB:EUTRa:DL:USER<ch>:AS:UL:CELL<st0>:SElement.....	700
[SOURce<hw>]:BB:EUTRa:DL:USER<ch>:AS:DL:CELL<st0>:SElement.....	700
[SOURce<hw>]:BB:EUTRa:DL:USER<ch>:AS:UL:CELL<st0>:APPend.....	700
[SOURce<hw>]:BB:EUTRa:DL:USER<ch>:AS:DL:CELL<st0>:APPend.....	700
[SOURce<hw>]:BB:EUTRa:DL:USER<ch>:AS:UL:CELL<st0>:INSert.....	700
[SOURce<hw>]:BB:EUTRa:DL:USER<ch>:AS:DL:CELL<st0>:INSert.....	700

<code>[:SOURce<hw>]:BB:EUTRa:DL:USER<ch>:AS:UL:CELL<st0>:DELeTe</code>	701
<code>[:SOURce<hw>]:BB:EUTRa:DL:USER<ch>:AS:DL:CELL<st0>:DELeTe</code>	701
<code>[:SOURce<hw>]:BB:EUTRa:DL:USER<ch>:AS:UL:CELL<st0>:RESet</code>	701
<code>[:SOURce<hw>]:BB:EUTRa:DL:USER<ch>:AS:DL:CELL<st0>:RESet</code>	701

`[:SOURce<hw>]:BB:EUTRa:DL:USER<ch>:AS:ARBLen?`

Queries the suggested ARB sequence length.

Return values:

`<SugArbLen>` integer
 Range: 1 to 1E4
 *RST: 0

Example: See [Example "How to enable and configure the auto sequence mode"](#) on page 689

Usage: Query only

Manual operation: See ["ARB Sequence Length > Suggested, Adjust Length"](#) on page 144

`[:SOURce<hw>]:BB:EUTRa:DL:USER<ch>:AS:ASLength`

Adjusts the ARB sequence length.

Example: See [Example "How to enable and configure the auto sequence mode"](#) on page 689

Usage: Event

Manual operation: See ["ARB Sequence Length > Suggested, Adjust Length"](#) on page 144

`[:SOURce<hw>]:BB:EUTRa:DL:USER<ch>:AS:DL:AFSeq <AutofillSeq>` `[:SOURce<hw>]:BB:EUTRa:DL:USER<ch>:AS:UL:AFSeq <AutofillSeq>`

Enables the automatic configuration of the DCIs.

Parameters:

`<AutofillSeq>` 1 | ON | 0 | OFF
 *RST: 1

Example: See [Example "How to enable and configure the auto sequence mode"](#) on page 689

Manual operation: See ["Autofill DL/UL Sequence"](#) on page 143

`[:SOURce<hw>]:BB:EUTRa:DL:USER<ch>:AS:DL:NHIDs <NumHARQIds>`

Sets the number of HARQ process IDs.

Parameters:

<NumHARQIds> integer
 Range: 1 to 15
 *RST: 8

Example: See [Example "How to enable and configure the auto sequence mode"](#) on page 689

Manual operation: See ["Number of HARQ Process IDs"](#) on page 143

[:SOURce<hw>]:BB:EUTRa:DL:USER<ch>:AS:DL:NHTRans <NumHARQTrans>
[:SOURce<hw>]:BB:EUTRa:DL:USER<ch>:AS:UL:NHTRans <NumHARQTrans>

Sets the number of HARQ transmissions.

Parameters:

<NumHARQTrans> integer
 Range: 1 to 32
 *RST: 4

Example: See [Example "How to enable and configure the auto sequence mode"](#) on page 689

Manual operation: See ["Number of HARQ Transmissions"](#) on page 143

[:SOURce<hw>]:BB:EUTRa:DL:USER<ch>:AS:DL:SKPRocess <SkipProc>

Skips HARQ process at unused subframes.

Parameters:

<SkipProc> 1 | ON | 0 | OFF
 *RST: 0

Example: See [Example "How to enable and configure the auto sequence mode"](#) on page 689

Manual operation: See ["Skip Process at Unused Subframes"](#) on page 144

[:SOURce<hw>]:BB:EUTRa:DL:USER<ch>:AS:DL:INDI <StartingNDI>

[:SOURce<hw>]:BB:EUTRa:DL:USER<ch>:AS:UL:INDI <StartingNDI>

Sets the new data indicator flag at the beginning of the sequence.

Parameters:

<StartingNDI> 1 | ON | 0 | OFF
 *RST: 1

Example: See [Example "How to enable and configure the auto sequence mode"](#) on page 689

Manual operation: See ["Initial NDI"](#) on page 143

**[:SOURCE<hw>]:BB:EUTRa:DL:USER<ch>:AS:DL[:CELL<ccid>]:
USUBframe<dir0> <UseSubfr>**

Sets the downlink subframes to be used for the HARQ transmission.

Suffix:

<dir0> 0 to 9
DL subframe number

Parameters:

<UseSubfr> 1 | ON | 0 | OFF
*RST: 1

Example: See [Example "How to enable and configure the auto sequence mode"](#) on page 689

Manual operation: See ["Subframes to Use:"](#) on page 144

[:SOURCE<hw>]:BB:EUTRa:DL:USER<ch>:AS:APPLY

Applies the selected auto sequence settings.

Example: See [Example "How to enable and configure the auto sequence mode"](#) on page 689

Usage: Event

Manual operation: See ["Apply"](#) on page 144

**[:SOURCE<hw>]:BB:EUTRa:DL:USER<ch>:AS:DL:CELL<st0>:MCSMode
<McsMode>**

Sets how the Modulation and Coding Scheme is configured.

Parameters:

<McsMode> MANual | FIXed | TCR
*RST: TCR

Example: See [Example "How to enable and configure the auto sequence mode"](#) on page 689

Manual operation: See ["MCS Mode"](#) on page 144

[:SOURCE<hw>]:BB:EUTRa:DL:USER<ch>:AS:DL:CELL<st0>:FMCS <FixedMcs>

Sets the MCS value.

Parameters:

<FixedMcs> integer
Range: 0 to 31
*RST: 0

Example: See [Example "How to enable and configure the auto sequence mode"](#) on page 689

Manual operation: See ["MCS"](#) on page 145

[:SOURCE<hw>]:BB:EUTRa:DL:USER<ch>:AS:DL:CELL<st0>:TCR <TargetCR>

Sets the target code rate.

Parameters:

<TargetCR> float
 Range: 0 to 1
 Increment: 0.001
 *RST: 0.333

Example: See [Example "How to enable and configure the auto sequence mode"](#) on page 689

Manual operation: See ["Target Code Rate, Target Modulation"](#) on page 145

[:SOURCE<hw>]:BB:EUTRa:DL:USER<ch>:AS:DL:CELL<st0>:TMOD <TargetMod>

Sets the target modulation.

Parameters:

<TargetMod> QPSK | QAM16 | QAM64 | QAM256
 *RST: QPSK

Example: See [Example "How to enable and configure the auto sequence mode"](#) on page 689

Options: QAM256 requires R&S SMM-K113

Manual operation: See ["Target Code Rate, Target Modulation"](#) on page 145

**[:SOURCE<hw>]:BB:EUTRa:DL:USER<ch>:AS:DL:CELL<st0>:RVCSequence
 <RVCodingSeq>**

Sets the redundancy version sequence.

Parameters:

<RVCodingSeq> string
 Up to 30 comma-separated values
 Range: 0 to 3 (for each value in the sequence)
 *RST: "0,1,2,3"

Example: See [Example "How to enable and configure the auto sequence mode"](#) on page 689

Manual operation: See ["RV coding Sequence"](#) on page 145

**[:SOURCE<hw>]:BB:EUTRa:DL:USER<ch>:AS:DL:CELL<st0>:SEQelem<dir0>:
 HARQ <HARQProc>**

Sets the HARQ process.

Parameters:

<HARQProc> integer
 Range: 0 to 15
 *RST: 0

Example: See [Example "How to enable and configure the auto sequence mode"](#) on page 689

Manual operation: See ["DL DCI Sequence Table"](#) on page 145

[:SOURce<hw>]:BB:EUTRa:DL:USER<ch>:AS:DL:CELL<st0>:SEQelem<dir0>:PDRE <ReMapQCL>

Sets the PDSCH RE mapping and QCL (quasi-co-location) indicator.

See also [\[:SOURce<hw>\]:BB:EUTRa:DL\[:SUBF<st0>\]:ENCC:PDCCh:EXTC:ITEM<ch0>:DCIConf:PDRE](#) on page 681

Parameters:

<ReMapQCL> integer
 Range: 0 to 3
 *RST: 0

Example: See [Example "How to enable and configure the auto sequence mode"](#) on page 689

Options: R&S SMM-K112

Manual operation: See ["DL DCI Sequence Table"](#) on page 145

[:SOURce<hw>]:BB:EUTRa:DL:USER<ch>:AS:DL:CELL<st0>:SLENgth?
[:SOURce<hw>]:BB:EUTRa:DL:USER<ch>:AS:UL:CELL<st0>:SLENgth?

Queries the sequence length as number of subframes.

Return values:

<ULSeqLength> integer
 Range: 0 to max
 *RST: 0
 Default unit: Subframes

Example: See [Example "How to enable and configure the auto sequence mode"](#) on page 689

Usage: Query only

Manual operation: See ["DL DCI Sequence Table"](#) on page 145
 See ["UL DCI Sequence Table"](#) on page 146

```
[ :SOURce<hw>]:BB:EUTRa:DL:USER<ch>:AS:DL:CELL<st0>:SEQelem<dir0>:
  SUBFrame <DLSubfrNo>
```

```
[ :SOURce<hw>]:BB:EUTRa:DL:USER<ch>:AS:UL:CELL<st0>:SEQelem<dir0>:
  SUBFrame <ASeqSubfrNo>
```

Sets the subframe number.

Parameters:

```
<ASeqSubfrNo>      integer
                    Range:    0 to max
                    *RST:    0
```

Example: See [Example "How to enable and configure the auto sequence mode"](#) on page 689

Manual operation: See ["UL DCI Sequence Table"](#) on page 146

```
[ :SOURce<hw>]:BB:EUTRa:DL:USER<ch>:AS:DL:CELL<st0>:SEQelem<dir0>:
  TB1:MCS <DIMcs>
```

```
[ :SOURce<hw>]:BB:EUTRa:DL:USER<ch>:AS:DL:CELL<st0>:SEQelem<dir0>:
  TB2:MCS <DIMcs>
```

Sets the MCS.

Parameters:

```
<DIMcs>            integer
                    Range:    0 to 31
                    *RST:    0
```

Example: See [Example "How to enable and configure the auto sequence mode"](#) on page 689

```
[ :SOURce<hw>]:BB:EUTRa:DL:USER<ch>:AS:DL:CELL<st0>:SEQelem<dir0>:
  TB1:NDI <DINdi>
```

```
[ :SOURce<hw>]:BB:EUTRa:DL:USER<ch>:AS:DL:CELL<st0>:SEQelem<dir0>:
  TB2:NDI <DINdi>
```

```
[ :SOURce<hw>]:BB:EUTRa:DL:USER<ch>:AS:UL:CELL<st0>:SEQelem<dir0>:
  NDI <UINDI>
```

Enables the new data indicator flag.

Parameters:

```
<UINDI>           1 | ON | 0 | OFF
                    *RST:    0
```

Example: See [Example "How to enable and configure the auto sequence mode"](#) on page 689

Manual operation: See ["UL DCI Sequence Table"](#) on page 146

```
[:SOURce<hw>]:BB:EUTRa:DL:USER<ch>:AS:DL:CELL<st0>:SEQelem<dir0>:
  TB1:RLCCounter <RLCCounter>
[:SOURce<hw>]:BB:EUTRa:DL:USER<ch>:AS:DL:CELL<st0>:SEQelem<dir0>:
  TB2:RLCCounter <RLCCounter>
```

Sets the RLC counter.

Parameters:

<RLCCounter> integer
 Range: 0 to 31
 *RST: 0

Example: See [Example "How to enable and configure the auto sequence mode"](#) on page 689

```
[:SOURce<hw>]:BB:EUTRa:DL:USER<ch>:AS:DL:CELL<st0>:SEQelem<dir0>:
  TB1:RV <DIRV>
[:SOURce<hw>]:BB:EUTRa:DL:USER<ch>:AS:DL:CELL<st0>:SEQelem<dir0>:
  TB2:RV <DIRV>
```

Sets the redundancy version.

Parameters:

<DIRV> integer
 Range: 0 to 3
 *RST: 0

Example: See [Example "How to enable and configure the auto sequence mode"](#) on page 689

```
[:SOURce<hw>]:BB:EUTRa:DL:USER<ch>:AS:DL:CELL<st0>:SEQelem<dir0>:
  CONFlit?
[:SOURce<hw>]:BB:EUTRa:DL:USER<ch>:AS:UL:CELL<st0>:SEQelem<dir0>:
  CONFlit?
```

Queries if there is conflict.

Return values:

<UISeqConflict> 1 | ON | 0 | OFF
 *RST: 0

Example: See [Example "How to enable and configure the auto sequence mode"](#) on page 689

Usage: Query only

Manual operation: See ["UL DCI Sequence Table"](#) on page 146

```
[:SOURce<hw>]:BB:EUTRa:DL:USER<ch>:AS:DL:CELL<st0>:URLCounter
  <UseRLCCounter>
```

Enables/disables the use of RLC counter.

Parameters:

<UseRLCCounter> 1 | ON | 0 | OFF
 *RST: 0

Example: See [Example "How to enable and configure the auto sequence mode"](#) on page 689

Manual operation: See ["Use RLC Counter"](#) on page 145

**[:SOURce<hw>]:BB:EUTRa:DL:USER<ch>:AS:UL:CELL<st0>:SEQelem<dir0>:
 RBA <UIRBA>**

Sets the UL RBA.

Parameters:

<UIRBA> integer
 Range: 0 to 2047
 *RST: 0

Example: See [Example "How to enable and configure the auto sequence mode"](#) on page 689

Manual operation: See ["UL DCI Sequence Table"](#) on page 146

**[:SOURce<hw>]:BB:EUTRa:DL:USER<ch>:AS:UL:CELL<st0>:SEQelem<dir0>:
 PTPC <PuschTpc>**

Sets the PUSCH TPC.

Parameters:

<PuschTpc> integer
 Range: 0 to 3
 *RST: 0

Example: See [Example "How to enable and configure the auto sequence mode"](#) on page 689

Manual operation: See ["UL DCI Sequence Table"](#) on page 146

**[:SOURce<hw>]:BB:EUTRa:DL:USER<ch>:AS:UL:CELL<st0>:SEQelem<dir0>:
 ULIndex <UlIndex>**

In TDD mode and with "UL/DL Configuration = 0", sets the parameter UL Index.

Parameters:

<UlIndex> integer
 Range: 0 to 3
 *RST: 0

Example: :SOURce1:BB:EUTRa:TDD:UDConf 0
 :SOURce1:BB:EUTRa:DL:USER1:AS:UL:CELL1:SEQelem1:ULIndex 0

Manual operation: See ["UL DCI Sequence Table"](#) on page 146

```
[:SOURce<hw>]:BB:EUTRa:DL:USER<ch>:AS:UL:CELL<st0>:VULTxpow
<VaryULTxPow>
```

Enables variation of the UL Tx power.

Parameters:

```
<VaryULTxPow>    1 | ON | 0 | OFF
*RST:            1
```

Example: See [Example "How to enable and configure the auto sequence mode"](#) on page 689

Manual operation: See ["Vary UL TX Power and RBA"](#) on page 146

```
[:SOURce<hw>]:BB:EUTRa:DL:USER<ch>:AS:UL:CELL<st0>:SElement
<SelElem>
```

```
[:SOURce<hw>]:BB:EUTRa:DL:USER<ch>:AS:DL:CELL<st0>:SElement
<SelElem>
```

Selects a table element (i.e. table row).

Parameters:

```
<SelElem>        integer
Range:           0 to 1499
*RST:            0
```

Example:

```
SOURce1:BB:EUTRa:DL:USER1:AS:DL:CELL0:APPend
SOURce1:BB:EUTRa:DL:USER1:AS:DL:CELL0:SElement
1
SOURce1:BB:EUTRa:DL:USER1:AS:DL:CELL0:INSert
SOURce1:BB:EUTRa:DL:USER1:AS:DL:CELL0:SElement
3
SOURce1:BB:EUTRa:DL:USER1:AS:DL:CELL0:DElete
SOURce1:BB:EUTRa:DL:USER1:AS:DL:CELL0:RESet
```

Manual operation: See ["Append, Insert, Delete, Reset"](#) on page 147

```
[:SOURce<hw>]:BB:EUTRa:DL:USER<ch>:AS:UL:CELL<st0>:APPend
[:SOURce<hw>]:BB:EUTRa:DL:USER<ch>:AS:DL:CELL<st0>:APPend
```

Appends a table element at the end of the table.

Example: See [\[:SOURce<hw>\]:BB:EUTRa:DL:USER<ch>:AS:DL:CELL<st0>:SElement](#) on page 700

Usage: Event

Manual operation: See ["Append, Insert, Delete, Reset"](#) on page 147

```
[:SOURce<hw>]:BB:EUTRa:DL:USER<ch>:AS:UL:CELL<st0>:INSert
[:SOURce<hw>]:BB:EUTRa:DL:USER<ch>:AS:DL:CELL<st0>:INSert
```

Inserts a table element before the selected one.

Example: See [:SOURce<hw>]:BB:EUTRa:DL:USER<ch>:AS:DL:CELL<st0>:SElement on page 700

Usage: Event

Manual operation: See "Append, Insert, Delete, Reset" on page 147

[:SOURce<hw>]:BB:EUTRa:DL:USER<ch>:AS:UL:CELL<st0>:DElete
[:SOURce<hw>]:BB:EUTRa:DL:USER<ch>:AS:DL:CELL<st0>:DElete

Deletes the selected table element.

Example: See [:SOURce<hw>]:BB:EUTRa:DL:USER<ch>:AS:DL:CELL<st0>:SElement on page 700

Usage: Event

Manual operation: See "Append, Insert, Delete, Reset" on page 147

[:SOURce<hw>]:BB:EUTRa:DL:USER<ch>:AS:UL:CELL<st0>:RESet
[:SOURce<hw>]:BB:EUTRa:DL:USER<ch>:AS:DL:CELL<st0>:RESet

Resets the DCI table, i.e. removes all table elements.

Example: See [:SOURce<hw>]:BB:EUTRa:DL:USER<ch>:AS:DL:CELL<st0>:SElement on page 700

Usage: Event

Manual operation: See "Append, Insert, Delete, Reset" on page 147

10.18 UL frame configuration

[:SOURce<hw>]:BB:EUTRa:UL:UE<st>:CONSubframes:PUCCh.....	702
[:SOURce<hw>]:BB:EUTRa:UL:UE<st>:CONSubframes:PUSCh.....	702
[:SOURce<hw>]:BB:EUTRa:UL[:SUBF<st0>]:CYCPrefix.....	702
[:SOURce<hw>]:BB:EUTRa:UL:RSTFrame.....	703
[:SOURce<hw>]:BB:EUTRa:UL[:SUBF<st0>]:ALLoc<ch0>:CONType.....	703
[:SOURce<hw>]:BB:EUTRa:UL[:CELL<ccidx>][:SUBF<st0>]:ALLoc<ch0>[:CW<cwid>][:PUSCh]:MODulation.....	703
[:SOURce<hw>]:BB:EUTRa:UL[:SUBF<st0>]:ALLoc<ch0>[:PUCCh]:FORMat.....	703
[:SOURce<hw>]:BB:EUTRa:UL[:SUBF<st0>]:ALLoc<ch0>:RBCount.....	704
[:SOURce<hw>]:BB:EUTRa:UL[:SUBF<st0>]:ALLoc<ch0>:PUCCh:RBCount?.....	704
[:SOURce<hw>]:BB:EUTRa:UL[:CELL<ccidx>][:SUBF<st0>]:ALLoc<ch0>:PUSCh:SET<user>:RBCount.....	704
[:SOURce<hw>]:BB:EUTRa:UL[:SUBF<st0>]:ALLoc<ch0>:VRBoffset.....	704
[:SOURce<hw>]:BB:EUTRa:UL[:CELL<ccidx>][:SUBF<st0>]:ALLoc<ch0>:PUSCh:SET<user>:VRBoffset.....	704
[:SOURce<hw>]:BB:EUTRa:UL[:SUBF<st0>]:SLOT<user0>:ALLoc<ch0>:RBOffset?.....	705
[:SOURce<hw>]:BB:EUTRa:UL[:SUBF<st0>]:SLOT<user0>:ALLoc<ch0>:PUCCh:RBOffset?.....	705

<code>[SOURce<hw>]:BB:EUTRa:UL[:CELL<ccidx>][:SUBF<st0>]:SLOT<user0>: ALLoc<ch0>:PUSCh:SET<gr>:RBOFFset?</code>	705
<code>[SOURce<hw>]:BB:EUTRa:UL[:SUBF<st0>]:ALLoc<ch0>[:CW<cwid>]:PHYSbits?</code>	705
<code>[SOURce<hw>]:BB:EUTRa:UL[:SUBF<st0>]:ALLoc<ch0>:PUCCh:PHYSbits?</code>	705
<code>[SOURce<hw>]:BB:EUTRa:UL[:CELL<ccidx>][:SUBF<st0>]:ALLoc<ch0>[:CW<cwid>]: PUSCh:PHYSbits?</code>	705
<code>[SOURce<hw>]:BB:EUTRa:UL[:SUBF<st0>]:ALLoc<ch0>:POWer</code>	706
<code>[SOURce<hw>]:BB:EUTRa:UL[:SUBF<st0>]:ALLoc<ch0>:PUCCh:POWer</code>	706
<code>[SOURce<hw>]:BB:EUTRa:UL[:CELL<ccidx>][:SUBF<st0>]:ALLoc<ch0>:PUSCh:POWer...</code>	706
<code>[SOURce<hw>]:BB:EUTRa:UL[:SUBF<st0>]:ALLoc<ch0>:STATe</code>	706
<code>[SOURce<hw>]:BB:EUTRa:UL[:SUBF<st0>]:ALLoc<ch0>:PUCCh:STATe</code>	706
<code>[SOURce<hw>]:BB:EUTRa:UL[:CELL<ccidx>][:SUBF<st0>]:ALLoc<ch0>:PUSCh:STATe.....</code>	706
<code>[SOURce<hw>]:BB:EUTRa:UL[:SUBF<st0>]:ALLoc<ch0>:CONFLict?</code>	706
<code>[SOURce<hw>]:BB:EUTRa:UL[:SUBF<st0>]:ALLoc<ch0>:PUCCh:CONFLict?</code>	706
<code>[SOURce<hw>]:BB:EUTRa:UL[:CELL<ccidx>][:SUBF<st0>]:ALLoc<ch0>:PUSCh: CONFLict?</code>	706

`[SOURce<hw>]:BB:EUTRa:UL:UE<st>:CONSubframes:PUCCh <ConfSubf>`

`[SOURce<hw>]:BB:EUTRa:UL:UE<st>:CONSubframes:PUSCh <ConfSubframes>`

Sets the number of configurable subframes.

Parameters:

`<ConfSubframes>` integer
 Range: 1 to 40
 *RST: 1

Example:

```
SOURce1:BB:EUTRa:UL:UE1:ID 100
SOURce1:BB:EUTRa:UL:UE2:ID 100
SOURce1:BB:EUTRa:UL:UE1:CONSubframes:PUCCh 10
SOURce1:BB:EUTRa:UL:UE1:CONSubframes:PUSCh 10
SOURce1:BB:EUTRa:UL:UE2:CONSubframes:PUCCh 8
SOURce1:BB:EUTRa:UL:UE2:CONSubframes:PUSCh 8
```

Manual operation: See ["Number Of PUCCH/PUSCH Configurations/Number Of Configurable Subframes"](#) on page 245

`[SOURce<hw>]:BB:EUTRa:UL[:SUBF<st0>]:CYCPrefix <CyclicPrefix>`

If `BB:EUTRa:UL:CPC USER`, sets the cyclic prefix for the selected subframe.

Parameters:

`<CyclicPrefix>` NORMal | EXTended
 *RST: NORMal

Example:

```
BB:EUTRa:UL:CPC USER
BB:EUTRa:UL:SUBF6:CYCP NORM
A normal prefix is used in subframe 6 in uplink.
```

Manual operation: See ["Cyclic Prefix \(UL\)"](#) on page 248

[:SOURce<hw>]:BB:EUTRa:UL:RSTFrame

Resets all subframe settings of the selected link direction to the default values.

Example: `BB:EUTR:UL:RSTF`
Resets the uplink subframe parameters of path A to the default settings.

Manual operation: See ["Reset All Subframes"](#) on page 248

[:SOURce<hw>]:BB:EUTRa:UL[:SUBF<st0>]:ALLoc<ch0>:CONType<ContentType>

Selects the content type for the selected allocation.

Parameters:
<ContentType> PUSCh | PUCCh | EMTc | NIOT
*RST: PUSCh

Example: `BB:EUTR:UL:SUBF4:ALL2:CONT PUSC`

Options: EMTc|NIOT require R&S SMM-K115

Manual operation: See ["Content \(UL\)"](#) on page 249
See ["UE/Content Type"](#) on page 312

[:SOURce<hw>]:BB:EUTRa:UL[:CELL<ccid>][:SUBF<st0>]:ALLoc<ch0>[:CW<cwid>][:PUSCh]:MODulation <Modulation>

Selects the modulation scheme for the allocation.

Suffix:
<cwid> 1..2
Codeword

Parameters:
<Modulation> QPSK | QAM16 | QAM64 | QAM256
*RST: QPSK

Example:
`SOURce1:BB:EUTRa:UL:UE1:RELease R10`
`SOURce1:BB:EUTRa:UL:SUBF0:ALLoc0:CONType PUSCh`
`SOURce1:BB:EUTRa:UL:SUBF0:ALLoc0:PUSCh:CODWords 1`
`SOURce1:BB:EUTRa:UL:SUBF0:ALLoc0:CW1:MODulation QPSK`
`SOURce1:BB:EUTRa:UL:SUBF0:ALLoc0:PHYSbits?`

Options: QAM256 requires R&S SMM-K119

Manual operation: See ["Modulation/Format"](#) on page 249

[:SOURce<hw>]:BB:EUTRa:UL[:SUBF<st0>]:ALLoc<ch0>[:PUCCh]:FORMat<Format>

Sets the PUCCH Format.

Parameters:

<Format> F1 | F1A | F1B | F2 | F2A | F2B | F3 | F4 | F5
 *RST: F1

Example:

SOUR:BB:EUTR:UL:SUBF4:ALL2:CONT PUC
 SOUR:BB:EUTR:UL:SUBF4:ALL2:FORM F2A

Options:

F4|F5 require R&S SMM-K119

Manual operation:

See "[Modulation/Format](#)" on page 249
 See "[PUCCH Format](#)" on page 322

[:SOURce<hw>]:BB:EUTRa:UL[:SUBF<st0>]:ALLoc<ch0>:RBCount
 <ResBlockCount>

[:SOURce<hw>]:BB:EUTRa:UL[:SUBF<st0>]:ALLoc<ch0>:PUCCh:RBCount?

**[:SOURce<hw>]:BB:EUTRa:UL[:CELL<ccidx>][:SUBF<st0>]:ALLoc<ch0>:
 PUSCh:SET<user>:RBCount <NumberOfRBs>**

Sets the size of the selected allocation in resource blocks (per slot).

Suffix:

<user> 1..2
 Set

Parameters:

<NumberOfRBs> integer
 Range: 0 to 110
 *RST: 0

Example:

BB:EUTR:UL:UE1:REL R89
 BB:EUTR:UL:SUBF0:ALL1:RBC 3

Example:

BB:EUTR:UL:UE2:REL R10
 BB:EUTR:UL:SUBF0:ALL2:PUC:RBC?
 BB:EUTR:UL:SUBF0:ALL2:PUSC:SET1:RBC 4
 BB:EUTR:UL:SUBF0:ALL2:PUSC:SET1:VRB 5
 BB:EUTR:UL:SUBF0:ALL2:PUSC:SET2:RBC 3
 BB:EUTR:UL:SUBF0:ALL2:PUSC:SET2:VRB 15

Manual operation: See "[Set 1/Set 2 No. RB](#)" on page 250

[:SOURce<hw>]:BB:EUTRa:UL[:SUBF<st0>]:ALLoc<ch0>:VRBoffset <VrbOffset>

**[:SOURce<hw>]:BB:EUTRa:UL[:CELL<ccidx>][:SUBF<st0>]:ALLoc<ch0>:
 PUSCh:SET<user>:VRBoffset <NumberOfVRBs>**

Sets the virtual resource block offset of the selected subframe.

Suffix:

<user> 1..2

Parameters:

<NumberOfVRBs> integer
 Range: 0 to 49
 *RST: 0

Example:
 BB:EUTR:UL:SUBF0:ALL1:VRB 6
 BB:EUTR:UL:SUBF0:ALL2:PUSC:SET1:VRB 5
 BB:EUTR:UL:SUBF0:ALL2:PUSC:SET1:VRB 15

Manual operation: See "[Set 1/Set 2 Offset VRB](#)" on page 251

[:SOURCE<hw>]:BB:EUTRa:UL[:SUBF<st0>]:SLOT<user0>:ALLOc<ch0>:RBOFFset?
[:SOURCE<hw>]:BB:EUTRa:UL[:SUBF<st0>]:SLOT<user0>:ALLOc<ch0>:PUCCh:RBOFFset?
[:SOURCE<hw>]:BB:EUTRa:UL[:CELL<ccidx>][:SUBF<st0>]:SLOT<user0>:ALLOc<ch0>:PUSCh:SET<gr>:RBOFFset?

Queries the start resource block of the selected allocation in slot n of the subframe.

Suffix:
 <user0> 0..1
 <s2us> 1..2

Return values:
 <RbOffs> integer
 Range: 0 to 49
 *RST: 2

Usage: Query only

Manual operation: See "[Offset PRB Slot \(n/n+1\)](#)" on page 251

[:SOURCE<hw>]:BB:EUTRa:UL[:SUBF<st0>]:ALLOc<ch0>[:CW<cwid>]:PHYSbits?
[:SOURCE<hw>]:BB:EUTRa:UL[:SUBF<st0>]:ALLOc<ch0>:PUCCh:PHYSbits?
[:SOURCE<hw>]:BB:EUTRa:UL[:CELL<ccidx>][:SUBF<st0>]:ALLOc<ch0>[:CW<cwid>]:PUSCh:PHYSbits?

Queries the number of physical bits for the selected allocation.

Suffix:
 <cwid> 1..2
 Codeword

Return values:
 <PuscPhysBits> integer
 Range: -1 to 105600
 *RST: -1

Example:
 SOURCE1:BB:EUTRa:UL:SUBF4:ALLOc2:CW1:PUSCh:PHYSbits?

Usage: Query only

Manual operation: See "[Phys. Bits / Total Number of Physical Bits](#)" on page 252

```
[:SOURce<hw>]:BB:EUTRa:UL[:SUBF<st0>]:ALLoc<ch0>:POWer <Power>
[:SOURce<hw>]:BB:EUTRa:UL[:SUBF<st0>]:ALLoc<ch0>:PUCCh:POWer
  <PuccPower>
[:SOURce<hw>]:BB:EUTRa:UL[:CELL<ccidx>][:SUBF<st0>]:ALLoc<ch0>:
  PUSCh:POWer <PuscPower>
```

Sets the power for the selected allocation.

Parameters:

```
<PuscPower>      float
                  Range:    -80 to 10
                  Increment: 0.001
                  *RST:     0
```

Example:

```
BB:EUTR:UL:SUBF4:ALL1:POW 3.00
BB:EUTR:UL:SUBF4:ALL2:PUSC:POW -1.00
BB:EUTR:UL:SUBF4:ALL2:PUC:POW -1.00
```

Manual operation: See "Power (UL)" on page 252

```
[:SOURce<hw>]:BB:EUTRa:UL[:SUBF<st0>]:ALLoc<ch0>:STATe <State>
[:SOURce<hw>]:BB:EUTRa:UL[:SUBF<st0>]:ALLoc<ch0>:PUCCh:STATe
  <PuccState>
[:SOURce<hw>]:BB:EUTRa:UL[:CELL<ccidx>][:SUBF<st0>]:ALLoc<ch0>:
  PUSCh:STATe <PuscState>
```

Sets the allocation state to active or inactive.

Note: Disabling an allocation deactivate the PUSCH/PUCCH and the corresponding demodulation reference signal, but does not affect other allocations of the UE or the sounding reference signal.

Parameters:

```
<PuccState>      1 | ON | 0 | OFF
                  *RST:    dynamic
```

Options: AUTO requires R&S SMM100A-K115

Manual operation: See "State (UL)" on page 252

```
[:SOURce<hw>]:BB:EUTRa:UL[:SUBF<st0>]:ALLoc<ch0>:CONFLict?
[:SOURce<hw>]:BB:EUTRa:UL[:SUBF<st0>]:ALLoc<ch0>:PUCCh:CONFLict?
[:SOURce<hw>]:BB:EUTRa:UL[:CELL<ccidx>][:SUBF<st0>]:ALLoc<ch0>:
  PUSCh:CONFLict?
```

Indicates a conflict between two allocations.

Return values:

```
<PuscConflict>  1 | ON | 0 | OFF
                  *RST:    OFF
```

Usage: Query only

Manual operation: See "Conflict (UL)" on page 253

10.19 UL carrier aggregation

Option: R&S SMM-K55 and R&S SMM-K112.

Example: Activating UL carrier aggregation

```
SOURcel:BB:EUTRa:LINK UP
SOURcel:BB:EUTRa:UL:CA:CELL0:DUPLexing FDD

SOURcel:BB:EUTRa:UL:CA:CELL1:INDEx 5
SOURcel:BB:EUTRa:UL:CA:CELL1:ID 10
SOURcel:BB:EUTRa:UL:CA:CELL1:BW BW20_00
SOURcel:BB:EUTRa:UL:CA:CELL1:SUConfiguration 0
SOURcel:BB:EUTRa:UL:CA:CELL1:CSRS 7
SOURcel:BB:EUTRa:UL:CA:CELL1:DMRS 0
SOURcel:BB:EUTRa:UL:CA:CELL1:TDELay 0

SOURcel:BB:EUTRa:UL:SUBF0:ALLOc0:PUCCh:STATe 1
SOURcel:BB:EUTRa:STATe 1
OUTPut1:STATe 1
OUTPut2:STATe 1
```

[:SOURce<hw>]:BB:EUTRa:UL:CA:STATe <ULCaGlobState>

Enables UL carrier aggregation.

Parameters:

<ULCaGlobState> 1 | ON | 0 | OFF
*RST: 0

Example: See [Chapter 10.19, "UL carrier aggregation"](#), on page 707

Manual operation: See ["Activate Carrier Aggregation"](#) on page 224

[:SOURce<hw>]:BB:EUTRa:UL:CA:CELL<ch0>:INDEx <ULCaCellIndex>

Sets the cell index of the corresponding SCell.

Parameters:

<ULCaCellIndex> integer
Range: 1 to 7
*RST: 1

Example: See [Chapter 10.19, "UL carrier aggregation"](#), on page 707

Manual operation: See ["Cell Index"](#) on page 224

[:SOURce<hw>]:BB:EUTRa:UL:CA:CELL<ch0>:ID <ULCaPhyCellId>

Sets the physical Cell ID of the PCell and the SCells.

Parameters:

<ULCaPhyCellId> integer
 Range: 0 to 503
 *RST: 0

Example: See [Chapter 10.19, "UL carrier aggregation"](#), on page 707

Manual operation: See ["Physical Cell ID"](#) on page 224

[[:SOURce<hw>]:BB:EUTRa:UL:CA:CELL<ch0>:BW <ULCaBw>

Sets the bandwidth of the corresponding component carrier.

Parameters:

<ULCaBw> BW1_40 | BW3_00 | BW5_00 | BW10_00 | BW15_00 |
 BW20_00
 *RST: BW10_00

Example: See [Chapter 10.19, "UL carrier aggregation"](#), on page 707

Manual operation: See ["Bandwidth"](#) on page 224

[[:SOURce<hw>]:BB:EUTRa:UL:CA:CELL<ch0>:DFReq <ULCaDeltaF>

Sets the frequency offset between the central frequency of corresponding SCell and the frequency of the PCell.

Example: See [Chapter 10.19, "UL carrier aggregation"](#), on page 707.

Manual operation: See ["delta f / MHz"](#) on page 224

[[:SOURce<hw>]:BB:EUTRa:UL:CA:CELL<ch0>:DUPLexing <ULCaDuplexMode>

Selects the duplexing mode of the component carriers.

Parameters:

<ULCaDuplexMode> TDD | FDD
 *RST: FDD

Example: See [Chapter 10.19, "UL carrier aggregation"](#), on page 707

Manual operation: See ["Duplexing"](#) on page 224

[[:SOURce<hw>]:BB:EUTRa:UL:CA:CELL<ch0>:UDConf <ULCaTddULDLConf>

Sets the Uplink-Downlink Configuration number.

Parameters:

<ULCaTddULDLConf>integer
 Range: 0 to 6
 *RST: 0

Example: See [Chapter 10.19, "UL carrier aggregation"](#), on page 707

Manual operation: See ["TDD UL/DL Configuration"](#) on page 224

[[:SOURce<hw>]:BB:EUTRa:UL:CA:CELL<ch0>:SUConfiguration
 <ULCaSrsSubfConf>

Sets the SRS subframe configuration per component carrier.

Parameters:

<ULCaSrsSubfConf> integer
 Range: 0 to 15
 *RST: 15

Example: See [Chapter 10.19, "UL carrier aggregation"](#), on page 707

Manual operation: See ["SRS Subframe Configuration"](#) on page 225

[[:SOURce<hw>]:BB:EUTRa:UL:CA:CELL<ch0>:DMRS <ULCaN1Dmrs>

Sets the parameter n(1)_DMRS per component carrier.

Parameters:

<ULCaN1Dmrs> integer
 Range: 0 to 11
 *RST: 0

Example: See [Chapter 10.19, "UL carrier aggregation"](#), on page 707

Manual operation: See ["n\(1\)_DMRS"](#) on page 225

[[:SOURce<hw>]:BB:EUTRa:UL:CA:CELL<ch0>:SPSConf <ULCaTddSSConf>

Sets the special subframeconfiguration number.

Parameters:

<ULCaTddSSConf> integer
 Range: 0 to 10
 *RST: 0

Example: See [Chapter 10.19, "UL carrier aggregation"](#), on page 707.

Options: R&S SMM-K119: special subframe configuration 10

Manual operation: See ["TDD Special Subframe Config"](#) on page 225

[[:SOURce<hw>]:BB:EUTRa:UL:CA:CELL<ch0>:CSRS <ULCaSrsCSRS>

Sets the parameter SRS Bandwidth Configuration per component carrier.

Parameters:

<ULCaSrsCSRS> integer
 Range: 0 to 7
 *RST: 0

Example: See [Chapter 10.19, "UL carrier aggregation"](#), on page 707

Manual operation: See ["SRS Bandwidth Configuration C_SRS"](#) on page 225

[:SOURCE<hw>]:BB:EUTRa:UL:CA:CELL<ch0>:TDElay <TimeDelay>

Sets the time delay of the SCell relative to the PCell.

Parameters:

<TimeDelay> integer
 Range: 0 to 7E5
 *RST: 0

Example: See [Chapter 10.19, "UL carrier aggregation"](#), on page 707

Manual operation: See ["Delay / ns"](#) on page 225

[:SOURCE<hw>]:BB:EUTRa:UL:CA:CELL<ch0>:STATE <ULCaCellState>

Activates the corresponding component carrier.

Parameters:

<ULCaCellState> 1 | ON | 0 | OFF
 *RST: 0

Example: See [Chapter 10.19, "UL carrier aggregation"](#), on page 707

Manual operation: See ["State"](#) on page 225

10.20 UL enhanced

[:SOURCE<hw>]:BB:EUTRa:UL[:CELL<ccidx>][:SUBF<st0>]:ALLoc<ch0>:PUSCh: PRECoding:SCHeme	712
[:SOURCE<hw>]:BB:EUTRa:UL[:CELL<ccidx>][:SUBF<st0>]:ALLoc<ch0>:PUSCh: CODWords	712
[:SOURCE<hw>]:BB:EUTRa:UL[:CELL<ccidx>][:SUBF<st0>]:ALLoc<ch0>:PUSCh: PRECoding:NOLayers	712
[:SOURCE<hw>]:BB:EUTRa:UL[:CELL<ccidx>][:SUBF<st0>]:ALLoc<ch0>:PUSCh: PRECoding:NAPused	713
[:SOURCE<hw>]:BB:EUTRa:UL[:CELL<ccidx>][:SUBF<st0>]:ALLoc<ch0>:PUSCh: PRECoding:CBINdex	713
[:SOURCE<hw>]:BB:EUTRa:UL[:CELL<ccidx>][:SUBF<st0>]:ALLoc<ch0>:PUSCh:DRS: NDMRs<layer>?	713
[:SOURCE<hw>]:BB:EUTRa:UL[:CELL<ccidx>][:SUBF<st0>]:ALLoc<ch0>:PUSCh: MAPPING	714
[:SOURCE<hw>]:BB:EUTRa:UL[:CELL<ccidx>][:SUBF<st0>]:ALLoc<ch0>:PUSCh: FHOP:STATE	714
[:SOURCE<hw>]:BB:EUTRa:UL[:CELL<ccidx>][:SUBF<st0>]:ALLoc<ch0>:PUSCh: FHOP:TYPE?	714

[SOURce<hw>]:BB:EUTRa:UL[:CELL<ccidx>][:SUBF<st0>]:ALLoc<ch0>:PUSCh: FHOP:IIHBits.....	715
[SOURce<hw>]:BB:EUTRa:UL[:CELL<ccidx>][:SUBF<st0>]:ALLoc<ch0>:PUSCh:DRS: CYCShift.....	715
[SOURce<hw>]:BB:EUTRa:UL[:CELL<ccidx>][:SUBF<st0>]:ALLoc<ch0>:PUSCh: HARQ:MODE.....	716
[SOURce<hw>]:BB:EUTRa:UL[:CELL<ccidx>][:SUBF<st0>]:ALLoc<ch0>:PUSCh: HARQ:NBUNdled.....	716
[SOURce<hw>]:BB:EUTRa:UL[:CELL<ccidx>][:SUBF<st0>]:ALLoc<ch0>:PUSCh: HARQ:BITS.....	716
[SOURce<hw>]:BB:EUTRa:UL[:CELL<ccidx>][:SUBF<st0>]:ALLoc<ch0>[:CW<cwid>]: PUSCh:HARQ:CBITs?.....	717
[SOURce<hw>]:BB:EUTRa:UL[:CELL<ccidx>][:SUBF<st0>]:ALLoc<ch0>:PUSCh: HARQ:PATtern.....	717
[SOURce<hw>]:BB:EUTRa:UL[:CELL<ccidx>][:SUBF<st0>]:ALLoc<ch0>:PUSCh:CQI: CBITs?.....	717
[SOURce<hw>]:BB:EUTRa:UL[:CELL<ccidx>][:SUBF<st0>]:ALLoc<ch0>:PUSCh:CQI: BITS.....	718
[SOURce<hw>]:BB:EUTRa:UL[:CELL<ccidx>][:SUBF<st0>]:ALLoc<ch0>:PUSCh:CQI: PATtern.....	718
[SOURce<hw>]:BB:EUTRa:UL[:CELL<ccidx>][:SUBF<st0>]:ALLoc<ch0>:PUSCh:CQI: CODWord?.....	719
[SOURce<hw>]:BB:EUTRa:UL[:CELL<ccidx>][:SUBF<st0>]:ALLoc<ch0>[:CW<cwid>]: PUSCh:RI:CBITs?.....	719
[SOURce<hw>]:BB:EUTRa:UL[:CELL<ccidx>][:SUBF<st0>]:ALLoc<ch0>:PUSCh:RI:BITS... PATtern.....	719
[SOURce<hw>]:BB:EUTRa:UL[:CELL<ccidx>][:SUBF<st0>]:ALLoc<ch0>:PUSCh:RI: PATtern.....	720
[SOURce<hw>]:BB:EUTRa:UL[:CELL<ccidx>][:SUBF<st0>]:ALLoc<ch0>[:CW<cwid>]: PUSCh:ULSch:BITS?.....	720
[SOURce<hw>]:BB:EUTRa:UL[:SUBF<st0>]:ALLoc<ch0>:PUSCh:ULSch:BITS<cw>?.....	721
[SOURce<hw>]:BB:EUTRa:UL[:CELL<ccidx>][:SUBF<st0>]:ALLoc<ch0>[:CW<cwid>]: PUSCh:CCODing:TBSize.....	721
[SOURce<hw>]:BB:EUTRa:UL[:CELL<ccidx>][:SUBF<st0>]:ALLoc<ch0>[:CW<cwid>]: PUSCh:CCODing:RVINdex.....	721
[SOURce<hw>]:BB:EUTRa:UL[:SUBF<st0>]:ALLoc<ch0>:PUCCh:NAPused?.....	722
[SOURce<hw>]:BB:EUTRa:UL[:SUBF<st0>]:ALLoc<ch0>:PUCCh:NPAR<ap>.....	722
[SOURce<hw>]:BB:EUTRa:UL[:SUBF<st0>]:ALLoc<ch0>:PUCCh:HARQ:BITS.....	723
[SOURce<hw>]:BB:EUTRa:UL[:SUBF<st0>]:ALLoc<ch0>:PUCCh:HARQ:CBITs?.....	723
[SOURce<hw>]:BB:EUTRa:UL[:SUBF<st0>]:ALLoc<ch0>:PUCCh:HARQ:PATtern.....	723
[SOURce<hw>]:BB:EUTRa:UL[:SUBF<st0>]:ALLoc<ch0>:PUCCh:CQI:CBITs?.....	724
[SOURce<hw>]:BB:EUTRa:UL[:SUBF<st0>]:ALLoc<ch0>:PUCCh:CQI:BITS.....	724
[SOURce<hw>]:BB:EUTRa:UL[:SUBF<st0>]:ALLoc<ch0>:PUCCh:CQI:PATtern.....	724
[SOURce<hw>]:BB:EUTRa:UL[:SUBF<st0>]:ALLoc<ch0>:PUCCh:MRB.....	725
[SOURce<hw>]:BB:EUTRa:UL[:SUBF<st0>]:ALLoc<ch0>:PUCCh:NOC.....	725
[SOURce<hw>]:BB:EUTRa:UL[:SUBF<st0>]:ALLoc<ch0>:PUCCh:CYCShift.....	725
[SOURce<hw>]:BB:EUTRa:UL[:SUBF<st0>]:ALLoc<ch0>:PUCCh:DMR1.....	726
[SOURce<hw>]:BB:EUTRa:UL[:SUBF<st0>]:ALLoc<ch0>:PUCCh:DMR2?.....	726

```
[:SOURce<hw>]:BB:EUTRa:UL[:CELL<ccidX>][:SUBF<st0>]:ALLoc<ch0>:
  PUSCh:PRECoding:SCHEME <PrecodingScheme>
```

Sets the PUSCH precoding scheme.

Parameters:

<PrecodingScheme> NONE | SPM

*RST: NONE

Example:

```
SOURce1:BB:EUTRa:UL:UE1:RELease R10
SOURce1:BB:EUTRa:UL:UE1:PUSCh:TXMode M2
SOURce1:BB:EUTRa:UL:UE1:PUSCh:NAP AP2
SOURce1:BB:EUTRa:UL:SUBF0:ALLoc0:PUSCh:PRECoding:SCHEME SPM
SOURce1:BB:EUTRa:UL:SUBF0:ALLoc0:PUSCh:CODWords 2
SOURce1:BB:EUTRa:UL:SUBF0:ALLoc0:PUSCh:PRECoding:NOLayers 4
SOURce1:BB:EUTRa:UL:SUBF0:ALLoc0:PUSCh:PRECoding:NAPused?
// Response: AP2
SOURce1:BB:EUTRa:UL:SUBF0:ALLoc0:PUSCh:PRECoding:CBIndex?
```

Options: R&S SMM-K85

Manual operation: See "[Precoding Scheme](#)" on page 313

```
[:SOURce<hw>]:BB:EUTRa:UL[:CELL<ccidX>][:SUBF<st0>]:ALLoc<ch0>:
  PUSCh:CODWords <NumOfCodeWords>
```

Sets the number of the used codeword.

Parameters:

<NumOfCodeWords> integer

Range: 1 to 2

*RST: 1

Example:

```
SOURce1:BB:EUTRa:UL:UE1:RELease LADV
SOURce1:BB:EUTRa:UL:CELL0:SUBF0:ALLoc0:PUSCh:
CODWords?
```

Options: R&S SMM-K85/-K112

Manual operation: See "[Codeword \(UL\)](#)" on page 249

See "[Number of Codewords](#)" on page 313

```
[:SOURce<hw>]:BB:EUTRa:UL[:CELL<ccidX>][:SUBF<st0>]:ALLoc<ch0>:
  PUSCh:PRECoding:NOLayers <NumberOfLayers>
```

Sets the number of layers used by the PUSCH precoding.

Parameters:

<NumberOfLayers> integer

Range: 1 to 4

*RST: 1

Example: See `[:SOURce<hw>] :BB:EUTRa:UL[:CELL<ccid>] [:SUBF<st0>] :ALLoc<ch0> :PUSCh:PRECoding:SCHEME` on page 712

Options: R&S SMM-K85

Manual operation: See "Number of Layers" on page 313

`[:SOURce<hw>] :BB:EUTRa:UL[:CELL<ccid>] [:SUBF<st0>] :ALLoc<ch0> :PUSCh:PRECoding:NAPused <NumUsedAntPorts>`

Sets the number of antenna ports the PUSCH transmission uses.

Parameters:

<NumUsedAntPorts> AP1 | AP2 | AP4
*RST: AP1

Example: See `[:SOURce<hw>] :BB:EUTRa:UL:UE<st> [:CELL<ccid>] :PUSCh:NAPort` on page 758

Options: R&S SMM-K85

Manual operation: See "Number of Used Antenna Port" on page 313

`[:SOURce<hw>] :BB:EUTRa:UL[:CELL<ccid>] [:SUBF<st0>] :ALLoc<ch0> :PUSCh:PRECoding:CBIndex <CodeBookIndex>`

Sets the codebook index.

Parameters:

<CodeBookIndex> integer
Range: 0 to 23
*RST: 0

Example: See `[:SOURce<hw>] :BB:EUTRa:UL[:CELL<ccid>] [:SUBF<st0>] :ALLoc<ch0> :PUSCh:PRECoding:SCHEME` on page 712

Options: R&S SMM-K85

Manual operation: See "Codebook Index" on page 313

`[:SOURce<hw>] :BB:EUTRa:UL[:CELL<ccid>] [:SUBF<st0>] :ALLoc<ch0> :PUSCh:DRS:NDMRs<layer>?`

Queries the parameter $n(2)_{DMRS,\lambda}$ (Layer λ).

Suffix:

<st0> 0..39
<ch0> 0..3
<layer> 0..3
Layer

Return values:

<Ndmrs> integer
 Range: 0 to 11
 *RST: 0

Example:

```
SOURce1:BB:EUTRa:UL:SUBF0:ALLoc1:PUSCh:DRS:
CYCShift 1
SOURce1:BB:EUTRa:UL:SUBF0:ALLoc1:PUSCh:DRS:
NDMRs1?
Response: 6
```

Usage: Query only

Options: R&S SMM-K85

Manual operation: See "[n\(2\)_DMRS, \$\lambda\$ \(Layer \$\lambda\$ \)](#)" on page 315

**[:SOURce<hw>]:BB:EUTRa:UL[:CELL<ccid>][:SUBF<st0>]:ALLoc<ch0>:
 PUSCh:MAPPING <BitsDmrsMapping>**

Sets the *Cyclic Shift Field mapping table for DMRS bit field*

Parameters:

<BitsDmrsMapping> 1 | ON | 0 | OFF
 *RST: 0

Example:

```
// enabling mapping the DMRS sequence on each second subcarrier
SOURce1:BB:EUTRa:UL:UE1:CELL0:REFSig:DRS:ENHanced 1
SOURce1:BB:EUTRa:UL:CELL0:SUBF0:ALLoc1:PUSCh:MAPPING 1
```

Manual operation: See "[Bit for DMRS Mapping Table](#)" on page 315

**[:SOURce<hw>]:BB:EUTRa:UL[:CELL<ccid>][:SUBF<st0>]:ALLoc<ch0>:
 PUSCh:FHOP:STATe <State>**

Enables/disables frequency hopping for PUSCH.

Parameters:

<State> 1 | ON | 0 | OFF
 *RST: OFF

Example:

```
BB:EUTRa:UL:SUBF4:ALL2:PUSCh:FHOP:STAT ON
Enables frequency hopping
```

Manual operation: See "[Frequency Hopping](#)" on page 314

**[:SOURce<hw>]:BB:EUTRa:UL[:CELL<ccid>][:SUBF<st0>]:ALLoc<ch0>:
 PUSCh:FHOP:TYPE?**

Queries the frequency hopping type used, as defined in 3GPP TS36.213.

Return values:

<Type> TP1 | TP2 | NONE
 *RST: NONE

Example:

BB:EUTRa:UL:SUBF4:ALL2:PUSC:FHOP:TYPE?
 Queries the frequency hopping type
 Response: TP2

Usage: Query only

Manual operation: See "[Hopping Type](#)" on page 314

**[:SOURce<hw>]:BB:EUTRa:UL[:CELL<ccid>][:SUBF<st0>]:ALLoc<ch0>:
 PUSCh:FHOP:IIHBits <InfoInHoppBits>**

Sets the information in hopping bits according to the PDCCH DCI format 0 hopping bit definition.

Parameters:

<InfoInHoppBits> integer
 Range: 0 to 3
 *RST: 1

Example:

BB:EUTRa:UL:SUBF4:ALL2:PUSC:FHOP:IIHB 0
 Sets the information in hopping bits

Manual operation: See "[Information in Hopping Bits](#)" on page 314

**[:SOURce<hw>]:BB:EUTRa:UL[:CELL<ccid>][:SUBF<st0>]:ALLoc<ch0>:
 PUSCh:DRS:CYCShift <Cyclicshift>**

Sets the cyclic shift field in the uplink-related DCI formats.

Suffix:

<st0> 0..39
 Subframe
 <ch0> 0..3
 Allocation

Parameters:

<Cyclicshift> int
 Range: 0 to 7
 Increment: 1
 *RST: 0

Example:

See [:SOURce<hw>]:BB:EUTRa:UL[:CELL<ccid>][:SUBF<st0>]:ALLoc<ch0>:PUSCh:DRS:NDMRs<layer>?
 on page 713

Options: R&S SMM-K85

Manual operation: See "[Cyclic Shift Field](#)" on page 314

```
[:SOURCE<hw>]:BB:EUTRa:UL[:CELL<ccid>][:SUBF<st0>]:ALLoc<ch0>:
PUSCh:HARQ:MODE <Mode>
```

Sets the ACK/NACK mode to Multiplexing or Bundling according to 3GPP TS 36.212, chapter 5.2.2.6.

ACK/NACK mode Bundling is defined for TDD duplexing mode only.

Parameters:

```
<Mode>          MUX | BUNDling
*RST:           MUX
```

Example: BB:EUTR:UL:SUBF4:ALL2:PUSC:HARQ:MODE MUX
Selects multiplexing HARQ mode

Manual operation: See "[ACK/NACK Mode](#)" on page 317

```
[:SOURCE<hw>]:BB:EUTRa:UL[:CELL<ccid>][:SUBF<st0>]:ALLoc<ch0>:
PUSCh:HARQ:NBUNDled <N_Bundled>
```

Sets the parameter N_bundled.

Parameters:

```
<N_Bundled>     integer
Range:          1 to 6
*RST:           1
```

Example: BB:EUTR:UL:SUBF4:ALL2:PUSC:HARQ:MODE BUND
BB:EUTR:UL:SUBF4:ALL2:PUSC:HARQ:NBUN 2

Manual operation: See "[N_bundled](#)" on page 317

```
[:SOURCE<hw>]:BB:EUTRa:UL[:CELL<ccid>][:SUBF<st0>]:ALLoc<ch0>:
PUSCh:HARQ:BITS <Bits>
```

Sets the number of ACK/NACK bits.

Set this parameter to 0 to deactivate the ACK/NACK transmission for the corresponding subframe.

Parameters:

```
<Bits>          integer
Range:          0 to dynamic
*RST:           1
```

Example: BB:EUTR:UL:SUBF4:ALL2:PUSC:HARQ:BITS 2
Sets the number of A/N bits

Manual operation: See "[Number of A/N Bits](#)" on page 317

```
[ :SOURce<hw>]:BB:EUTRa:UL[:CELL<ccidX>][:SUBF<st0>]:ALLoc<ch0>[:
  CW<cwid>]:PUSCh:HARQ:CBITs?
```

Queries the number of coded ACK/NACK bits per codeword.

Suffix:

```
<cwid>          1..2
                  Codeword
```

Return values:

```
<Codedbits>    integer
                  Range:    0 to max
                  Increment: 0
                  *RST:     2
```

Example:

```
SOURce1:BB:EUTRa:UL:SUBF4:ALLoc2:PUSCh:HARQ:
BITS 2
Sets the number of A/N bits
SOURce1:BB:EUTRa:UL:SUBF4:ALLoc2:CW1:PUSCh:
HARQ:CBITs?
Response: 8
```

Usage: Query only

Manual operation: See "[Number of Coded A/N Bits \(CW\)](#)" on page 317

```
[ :SOURce<hw>]:BB:EUTRa:UL[:CELL<ccidX>][:SUBF<st0>]:ALLoc<ch0>:
  PUSCh:HARQ:PATtern <Pattern>, <BitCount>
```

Sets the ACK/NACK pattern for the PUSCH.

Parameters:

```
<Pattern>       1024 bits
                  *RST:    #H0

<BitCount>     1024 bits
                  Range:    1 to 64
                  *RST:     1
```

Example:

```
// Set 2-bit HARQ-ACK control information
BB:EUTRa:UL:SUBF4:ALL2:PUSCh:HARQ:ACKT BIT2
BB:EUTRa:UL:SUBF4:ALL2:PUSCh:HARQ:PATT #B10,2
```

Manual operation: See "[ACK/NACK Pattern](#)" on page 317

```
[ :SOURce<hw>]:BB:EUTRa:UL[:CELL<ccidX>][:SUBF<st0>]:ALLoc<ch0>:
  PUSCh:CQI:CBITs?
```

Queries the number of coded CQI bits.

Return values:

<CodedBits> integer
 Range: 0 to max
 *RST: 22

Example:

SOURce1:BB:EUTRa:UL:SUBF4:ALLoc2:PUSCh:CQI:CBITs?
 Queries the number of coded CQI bits

Usage:

Query only

Manual operation: See "Number of Coded CQI Bits" on page 319

[:SOURce<hw>]:BB:EUTRa:UL[:CELL<ccid>][:SUBF<st0>]:ALLoc<ch0>:PUSCh:CQI:BITS <Bits>

Sets the number of CQI bits before channel coding.

Parameters:

<Bits> integer
 Range: dynamic to 1024
 *RST: 10

Example:

See [:SOURce<hw>]:BB:EUTRa:UL[:CELL<ccid>][:SUBF<st0>]:ALLoc<ch0>:PUSCh:CQI:PaTTern on page 718

Manual operation: See "Number of CQI Bits" on page 319

[:SOURce<hw>]:BB:EUTRa:UL[:CELL<ccid>][:SUBF<st0>]:ALLoc<ch0>:PUSCh:CQI:PaTTern <Pattern>, <BitCount>

Sets the CQI pattern for the PUSCH.

The length of the pattern is determined by the number of CQI bits ([:SOURce<hw>]:BB:EUTRa:UL[:CELL<ccid>][:SUBF<st0>]:ALLoc<ch0>:PUSCh:CQI:BITS).

Parameters:

<Pattern> numeric
 *RST: #H0

<BitCount> integer
 Range: 1 to 1024
 *RST: 1

Example:

SOURce1:BB:EUTRa:UL:SUBF4:ALLoc2:PUSCh:CQI:BITS 6
 SOURce1:BB:EUTRa:UL:SUBF4:ALLoc2:PUSCh:CQI:PaTTern #H100100,6

Manual operation: See "CQI Pattern" on page 319

```
[:SOURce<hw>]:BB:EUTRa:UL[:CELL<ccid>][:SUBF<st0>]:ALLoc<ch0>:
PUSCh:CQI:CODWord?
```

Queries the codeword the CQI is mapped to.

Return values:

```
<CqiCodeWord>      CW1 | CW2
*RST:              CW1
```

Example:

```
SOURce1:BB:EUTRa:UL:UE1:RELease LADV
:SOURce1:BB:EUTRa:UL:UE1:PUSCh:TXMode M2
:SOURce1:BB:EUTRa:UL:UE1:PUSCh:CCODing:STATe 1
:SOURce1:BB:EUTRa:UL:UE1:PUSCh:CCODing:MODE COMB
:SOURce1:BB:EUTRa:UL:SUBF0:ALLoc0:PUSCh:CODWords 2
:SOURce1:BB:EUTRa:UL:SUBF0:ALLoc0:PUSCh:CQI:CODWord?
// Response: CW1
```

Usage: Query only

Options: R&S SMM-K85

Manual operation: See "[CQI mapped to](#)" on page 319

```
[:SOURce<hw>]:BB:EUTRa:UL[:CELL<ccid>][:SUBF<st0>]:ALLoc<ch0>[:
CW<cwid>]:PUSCh:RI:CBITs?
```

Queries the number of coded RI bits per codeword.

Suffix:

```
<cwid>             1..2
                  Codeword
```

Return values:

```
<CodedRiBits>     integer
                  Range: 0 to max
                  *RST: 4
```

Example:

```
SOURce1:BB:EUTRa:UL:SUBF0:ALLoc0:PUSCh:RI:BITS 6
:SOURce1:BB:EUTRa:UL:SUBF0:ALLoc0:CW1:PUSCh:RI:CBITs?
// Response: 14
```

Usage: Query only

Manual operation: See "[Number of Coded RI Bits \(CW\)](#)" on page 318

```
[:SOURce<hw>]:BB:EUTRa:UL[:CELL<ccid>][:SUBF<st0>]:ALLoc<ch0>:
PUSCh:RI:BITS <Bits>
```

Sets the number of rank indication (RI) bits.

Set this parameter to 0 to deactivate the RI for the corresponding subframe.

Parameters:

<Bits> integer
 Range: 0 to 512
 *RST: 1

Example:

```
BB:EUTRa:UL:SUBF4:ALL2:PUSC:CQI:BITS 2
```

Sets the number of RI bits

Manual operation: See ["Number of RI Bits"](#) on page 318

```
[:SOURce<hw>]:BB:EUTRa:UL[:CELL<ccid>]:SUBF<st0>]:ALLoc<ch0>:
PUSCh:RI:PATtern <Pattern>, <BitCount>
```

Sets the RI pattern for the PUSCH.

Parameters:

<Pattern> numeric
 *RST: #H0

<BitCount> integer
 Range: 1 to 1024
 *RST: 1

Example:

```
// Set the number of RI bits
BB:EUTRa:UL:SUBF4:ALL2:PUSC:RI:BITS 2
BB:EUTRa:UL:SUBF4:ALL2:PUSC:RI:PATT #H10,2
```

Manual operation: See ["RI Pattern"](#) on page 318

```
[:SOURce<hw>]:BB:EUTRa:UL[:CELL<ccid>]:SUBF<st0>]:ALLoc<ch0>[:
CW<cwid>]:PUSCh:ULSch:BITS?
```

Queries the number of physical bits used for UL-SCH transmission.

Suffix:

<cwid> 1..2
 Codeword

Return values:

<PhysBitCount> integer
 Range: 0 to max
 *RST: 1500

Example:

```
SOURce1:BB:EUTRa:UL:SUBF0:ALLoc0:CW1:PUSCh:
ULSch:BITS?
```

Queries the number of physical bits for UL-SCH
 Response: 5688

Usage: Query only

Manual operation: See ["Number of Coded UL-SCH Bits"](#) on page 320

[:SOURce<hw>]:BB:EUTRa:UL[:SUBF<st0>]:ALLoc<ch0>:PUSCh:ULSch:BITS<cw>?

Queries the number of physical bits used for UL-SCH transmission.

Suffix:

<cw> 1..2
Codeword

Return values:

<PhysBitCount> integer
Range: 0 to max
Increment: 1
*RST: 1500

Example:

SOURce1:BB:EUTRa:UL:SUBF0:ALLoc0:PUSCh:ULSch:BITS1?
Queries the number of physical bits for UL-SCH
Response: 5688

Usage: Query only

[:SOURce<hw>]:BB:EUTRa:UL[:CELL<ccidX>][:SUBF<st0>]:ALLoc<ch0>[:CW<cwid>]:PUSCh:CCODing:TBSize <TranspBlockSize>

Sets the size of the transport block.

Suffix:

<cwid> 1 | 2
Codeword

Parameters:

<TranspBlockSize> integer
Range: 0 to 253440
*RST: 1500

Example:

SOURce1:BB:EUTRa:UL:SUBF4:ALLoc2:CW0:PUSCh:CCODing:TBSize 100
SOURce1:BB:EUTRa:UL:SUBF4:ALLoc2:CW2:PUSCh:CCODing:TBSize 1500

Manual operation: See "[Transport Block Size/Payload \(PUSCH\)](#)" on page 320

[:SOURce<hw>]:BB:EUTRa:UL[:CELL<ccidX>][:SUBF<st0>]:ALLoc<ch0>[:CW<cwid>]:PUSCh:CCODing:RVIndex <RedundVersIndex>

Sets the redundancy version index.

Suffix:

<cwid> 1..2
Codeword

Parameters:

<RedundVersIndex> integer
 Range: 0 to 3
 *RST: 0

Example:

```
SOURce1:BB:EUTRa:UL:SUBF4:ALLoc2:CW1:PUSCh:
CCODing:RVINdex 2
Sets the redundancy version index
```

Manual operation: See "[Redundancy Version Index \(PUSCH\)](#)" on page 321

[:SOURce<hw>]:BB:EUTRa:UL[:SUBF<st0>]:ALLoc<ch0>:PUCCh:NAPused?

Queries the number of antenna ports used for transmissions of the current PUCCH format.

Return values:

<NumAntennaPorts> integer
 Range: 1 to 2
 *RST: 1

Example:

```
SOURce1:BB:EUTRa:UL:UE1:RELease R10
SOURce1:BB:EUTRa:UL:UE1:PUCCh:F1Naport AP2
SOURce1:BB:EUTRa:UL:UE1:PUCCh:F2Naport AP1
SOURce1:BB:EUTRa:UL:UE1:PUCCh:F3Naport AP1
SOURce1:BB:EUTRa:UL:SUBF0:ALloc0:PUCCh:NAPused?
// Response: 2
SOURce1:BB:EUTRa:UL:SUBF0:ALloc0:FORMat F2B
SOURce1:BB:EUTRa:UL:SUBF0:ALloc0:PUCCh:NAPused?
// Response: 1
```

Usage: Query only

Options: R&S SMM-K85

Manual operation: See "[Number of Used Antenna Ports](#)" on page 322

**[:SOURce<hw>]:BB:EUTRa:UL[:SUBF<st0>]:ALLoc<ch0>:PUCCh:NPAR<ap>
<NPar>**

Sets the resource index for the supported PUCCH formats.

Suffix:

<ap> 0..1
 Antenna port index

Parameters:

<NPar> integer
 n(x)_PUCCH_max depends on the PUCCH format; to query the value, use the corresponding command, for example [:
[SOURce<hw>\]:BB:EUTRa:UL:PUCCh:N1EMax?](#).
 Range: 0 to n(x)_PUCCH_max
 *RST: 0

Example: [SOURce1:BB:EUTRa:UL:SUBF1:ALLoc2:PUCCh:NPAr0](#) 10

Manual operation: See "[n_PUCCH](#)" on page 322

[:SOURce<hw>]:BB:EUTRa:UL[:SUBF<st0>]:ALLoc<ch0>:PUCCh:HARQ:BITS
 <Bits>

(PUCCH format ≥ 3)

Sets the number of ACK/NACK+SR+CSI bits before channel coding.

Parameters:

<Bits> Max number of bits depend on the PUCCH format
 Range: 1 to dynamic
 *RST: 1

Manual operation: See "[Number of A/N+SR+CSI Bits](#)" on page 326

[:SOURce<hw>]:BB:EUTRa:UL[:SUBF<st0>]:ALLoc<ch0>:PUCCh:HARQ:CBITS?

(PUCCH format ≥ 3)

Queries the number of coded ACK/NACK+SR+CSI bits.

Return values:

<CBits> integer
 Range: 0 to 48
 *RST: 0

Usage: Query only

Manual operation: See "[Number of Coded A/N+SR+CSI Bits](#)" on page 326

[:SOURce<hw>]:BB:EUTRa:UL[:SUBF<st0>]:ALLoc<ch0>:PUCCh:HARQ:
PATtern <Pattern>, <BitCount>

Sets the PUCCH ACK/NACK pattern or ACK/NACK + SR pattern per subframe.

Parameters:

<Pattern> 1024 bits
 *RST: #H0

<BitCount> 1024 bits
 Range: 1 to 32
 *RST: 1

Example: SOURCE1:BB:EUTRa:SLENgth 4
 SOURCE1:BB:EUTRa:UL:UE1:CONSubframes:PUCCh 8
 SOURCE1:BB:EUTRa:UL:SUBF0:ALLoc1:FORMat F1A
 SOURCE1:BB:EUTRa:UL:SUBF4:ALLoc2:PUCCh:HARQ:PATtern #B01001,5
 SOURCE1:BB:EUTRa:UL:SUBF0:ALLoc1:FORMat F1B

Manual operation: See "[A/N Pattern / A/N+SR+CSI Pattern](#)" on page 324

[:SOURCE<hw>]:BB:EUTRa:UL[:SUBF<st0>]:ALLoc<ch0>:PUCCh:CQI:CBITs?

Queries the number of coded CQI bits.

Return values:

<CodedBits> integer
 Range: 0 to max
 *RST: 20

Example: SOURCE1:BB:EUTRa:UL:SUBF4:ALLoc2:PUCCh:CQI:CBITs?
 Queries sets the number of coded CQI bits
 Response: 20

Usage: Query only

Manual operation: See "[Number of Coded CQI Bits](#)" on page 326

**[:SOURCE<hw>]:BB:EUTRa:UL[:SUBF<st0>]:ALLoc<ch0>:PUCCh:CQI:BITS
 <Bits>**

Sets the number of CQI bits before channel coding.

Parameters:

<Bits> integer
 Range: 1 to 13
 *RST: 4

Example: See [:SOURCE<hw>]:BB:EUTRa:UL[:SUBF<st0>]:ALLoc<ch0>:PUCCh:CQI:PATtern on page 724

Manual operation: See "[Number of CQI Bits](#)" on page 325

**[:SOURCE<hw>]:BB:EUTRa:UL[:SUBF<st0>]:ALLoc<ch0>:PUCCh:CQI:PATtern
 <Pattern>, <BitCount>**

Sets the CQI pattern for the PUCCH.

The length of the pattern is determined by the number of CQI bits ([:SOURCE<hw>]:BB:EUTRa:UL[:SUBF<st0>]:ALLoc<ch0>:PUCCh:CQI:BITS).

Parameters:

<Pattern> numeric
 *RST: #H1

<BitCount> integer
 Range: 1 to 13
 *RST: 4

Example:

```
SOURce1:BB:EUTRa:UL:SUBF4:ALLoc2:PUCCh:CQI:BITS 6
SOURce1:BB:EUTRa:UL:SUBF4:ALLoc2:PUCCh:CQI:PATtern #B100100,6
```

Manual operation: See "[CQI Pattern](#)" on page 326

[:SOURce<hw>]:BB:EUTRa:UL[:SUBF<st0>]:ALLoc<ch0>:PUCCh:MRB
 <PucchMRB>

Sets the number of resource blocks used by PUCCH format 5.

Parameters:

<PucchMRB> 1 | 2 | 3 | 4 | 5 | 6 | 8
 *RST: 1

Example:

```
SOURce1:BB:EUTRa:UL:SUBF0:ALLoc0:PUCCh:FORMat F5
SOURce1:BB:EUTRa:UL:SUBF0:ALLoc0:PUCCh:MRB 1
```

Options: R&S SMM-K119

Manual operation: See "[M_RB](#)" on page 326

[:SOURce<hw>]:BB:EUTRa:UL[:SUBF<st0>]:ALLoc<ch0>:PUCCh:NOC <NOC>

Sets the PUCCH format 4 index n_{oc} .

Parameters:

<NOC> integer
 Range: 0 to 1
 *RST: 0

Example:

```
SOURce1:BB:EUTRa:UL:SUBF0:ALLoc0:PUCCh:FORMat F5
SOURce1:BB:EUTRa:UL:SUBF0:ALLoc0:PUCCh:NOC 1
```

Options: R&S SMM-K119

Manual operation: See "[n_oc](#)" on page 326

[:SOURce<hw>]:BB:EUTRa:UL[:SUBF<st0>]:ALLoc<ch0>:PUCCh:CYCShift
 <CyclicShiftDmrs>

Sets the cyclic shift.

Parameters:

<CyclicShiftDmrs> integer
 Range: 0 to 7
 *RST: 0

Example:

```
SOURce1:BB:EUTRa:UL:SUBF0:ALLoc0:PUCCh:FORMat F5
SOURce1:BB:EUTRa:UL:SUBF0:ALLoc0:PUCCh:CYCShift 4
SOURce1:BB:EUTRa:UL:SUBF0:ALLoc0:PUCCh:DMR1?
// 6
SOURce1:BB:EUTRa:UL:SUBF0:ALLoc0:PUCCh:DMR1 2
SOURce1:BB:EUTRa:UL:SUBF0:ALLoc0:PUCCh:CYCShift?
// 1
```

Options: R&S SMM-K119

Manual operation: See "[Cyclic Shift Field](#)" on page 327

[:SOURce<hw>]:BB:EUTRa:UL[:SUBF<st0>]:ALLoc<ch0>:PUCCh:DMR1
 <PuccDmrs1>

Sets the index $n^{(2)}_{\text{DMRS}}$.

Parameters:

<PuccDmrs1> 0 | 2 | 3 | 4 | 6 | 8 | 9 | 10
 *RST: 0

Example:

See [\[:SOURce<hw>\]:BB:EUTRa:UL\[:SUBF<st0>\]:ALLoc<ch0>:PUCCh:CYCShift](#) on page 725.

Options: R&S SMM-K119

Manual operation: See "[n\(1\)_DMRS](#)" on page 328

[:SOURce<hw>]:BB:EUTRa:UL[:SUBF<st0>]:ALLoc<ch0>:PUCCh:DMR2?

Queries the index $n^{(2)}_{\text{DMRS}}$.

Return values:

<PuccDmrs2> integer
 Range: 0 to 6
 *RST: 0

Example:

```
SOURce1:BB:EUTRa:UL:SUBF0:ALLoc0:PUCCh:FORMat F5
SOURce1:BB:EUTRa:UL:SUBF0:ALLoc0:PUCCh:DMR2?
// 0
```

Usage: Query only

Options: R&S SMM-K119

Manual operation: See "[n\(2\)_DMRS](#)" on page 328

10.21 User configuration

[SOURce<hw>]:BB:EUTRa:DL:USER<ch>:STATe.....	727
[SOURce<hw>]:BB:EUTRa:DL:USER<ch>:CA:STATe.....	728
[SOURce<hw>]:BB:EUTRa:DL:USER<ch>:TXM.....	728
[SOURce<hw>]:BB:EUTRa:DL:USER<ch>:CELL<st0>:TXM.....	728
[SOURce<hw>]:BB:EUTRa:DL:USER<ch>:UEC.....	728
[SOURce<hw>]:BB:EUTRa:DL:USER<ch>:ULCA<st0>:STATe.....	729
[SOURce<hw>]:BB:EUTRa:DL:USER<ch>:APM:CELL.....	729
[SOURce<hw>]:BB:EUTRa:DL:USER<ch>:APM:CBCI.....	729
[SOURce<hw>]:BB:EUTRa:DL:USER<ch>:APM:CBUA.....	729
[SOURce<hw>]:BB:EUTRa:DL:USER<ch>:APM:CBIndex[<dir>].....	730
[SOURce<hw>]:BB:EUTRa:DL:USER<ch>:APM:MAPCoordinates.....	730
[SOURce<hw>]:BB:EUTRa:DL:USER<ch>:APM:MODE.....	731
[SOURce<hw>]:BB:EUTRa:DL:USER<ch>:APM[:LAYer<user>]:AP<dir0>:BB<st0>:REAL....	731
[SOURce<hw>]:BB:EUTRa:DL:USER<ch>:APM[:LAYer<user>]:AP<dir0>:BB<st0>: IMAGinary.....	731
[SOURce<hw>]:BB:EUTRa:DL:USER<ch>:CCODing:STATe.....	732
[SOURce<hw>]:BB:EUTRa:DL:USER<ch>:UEID.....	732
[SOURce<hw>]:BB:EUTRa:DL:USER<ch>:DATA.....	732
[SOURce<hw>]:BB:EUTRa:DL:USER<ch>:DSElect.....	733
[SOURce<hw>]:BB:EUTRa:DL:USER<ch>:PATtern.....	733
[SOURce<hw>]:BB:EUTRa:DL:USER<ch>:INITpattern.....	733
[SOURce<hw>]:BB:EUTRa:DL:USER<ch>:EIMTanti.....	734
[SOURce<hw>]:BB:EUTRa:DL:USER<ch>:PA.....	734
[SOURce<hw>]:BB:EUTRa:DL:USER<ch>:ASRS:STATe.....	734
[SOURce<hw>]:BB:EUTRa:DL:USER<ch>:CAW:STATe.....	734
[SOURce<hw>]:BB:EUTRa:DL:USER<ch>:CELL<st0>:MCS.....	735
[SOURce<hw>]:BB:EUTRa:DL:USER<ch>:CELL<st0>:TBAL.....	735
[SOURce<hw>]:BB:EUTRa:DL:USER<ch>:MCSTwo:STATe.....	735
[SOURce<hw>]:BB:EUTRa:DL:USER<ch>:TALTindex:STATe.....	736
[SOURce<hw>]:BB:EUTRa:DL:USER<ch>:CELL<st0>:DMRS:STATe.....	736
[SOURce<hw>]:BB:EUTRa:DL:USER<ch>:CELL<st0>:SEOL:STATe.....	736
[SOURce<hw>]:BB:EUTRa:DL:USER<ch>:STHP:STATe.....	736
[SOURce<hw>]:BB:EUTRa:DL:USER<ch>:SCRambling:STATe.....	737
[SOURce<hw>]:BB:EUTRa:DL:USER<ch>:SCRambling:CELL<st>:DMRS:USE.....	737
[SOURce<hw>]:BB:EUTRa:DL:USER<ch>:SCRambling:CELL<st>:DMRS:ID1.....	738
[SOURce<hw>]:BB:EUTRa:DL:USER<ch>:SCRambling:CELL<st>:DMRS:ID2.....	738

[SOURce<hw>]:BB:EUTRa:DL:USER<ch>:STATe <UserState>

Enables/disables a user.

Parameters:

<UserState> 1 | ON | 0 | OFF
 *RST: 1

Example: SOURce1:BB:EUTRa:DL:USER1:STATe OFF

Manual operation: See "State" on page 132

[:SOURce<hw>]:BB:EUTRa:DL:USER<ch>:CA:STATe <State>

Enables/disables carrier aggregation for the selected user.

Parameters:

<State> 1 | ON | 0 | OFF
 *RST: 0

Manual operation: See "[Activate CA](#)" on page 132

[:SOURce<hw>]:BB:EUTRa:DL:USER<ch>:TXM <TxMode>

Sets the transmission mode of the according user as defined in [TS 36.213](#).

Parameters:

<TxMode> USER | M1 | M2 | M3 | M4 | M5 | M6 | M7 | M8 | M9 | M10
 *RST: USER
 Option:R&S SMM-K115
 <TxMode> = USER|M1|M2|M6|M9

Example: SOURce1:BB:EUTRa:DL:USER1:TXM M6

Manual operation: See "[Tx Modes](#)" on page 133

[:SOURce<hw>]:BB:EUTRa:DL:USER<ch>:CELL<st0>:TXM <TxMode>

Sets the transmission mode of the user.

Suffix:

<st0> 0 to 4
 0 = PCell, 1 to 4 = SCell1 to SCell4

Parameters:

<TxMode> USER | M1 | M2 | M3 | M4 | M5 | M6 | M7 | M8 | M9 | M10
 *RST: USER

Example: SOURce1:BB:EUTRa:DL:USER1:CELL0:TXM M9

SOURce1:BB:EUTRa:DL:USER1:CELL1:TXM M7

Manual operation: See "[Tx Modes](#)" on page 133

[:SOURce<hw>]:BB:EUTRa:DL:USER<ch>:UEC <UECategory>

Sets the UE Category.

Parameters:

<UECategory> USER | C1 | C2 | C3 | C4 | C5 | C6 | C7 | C8 | C9 | C10 | C11 |
 C12 | C13 | C14 | C15 | C16 | C17 | C18 | C19 | C20 | M1 | NB1 |
 M2 | NB2
 *RST: USER

Options: M1|NB1 require R&S SMM-K115

M2|NB2 require R&S SMM-K143

Manual operation: See ["UE Category"](#) on page 134

[[:SOURce<hw>]:BB:EUTRa:DL:USER<ch>:ULCA<st0>:STATE <CuUICaState>

Sets the state of the associated UL carriers, if carrier aggregation is enabled.

Suffix:

<st0> 0 to 4
 0 = PCell, 1 to 4 = SCell1 to SCell4
 LAA SCeLLs cannot be associated with UL carriers; the corresponding UL carrier state is always off.

Parameters:

<CuUICaState> 1 | ON | 0 | OFF
 *RST: 0

Example:

```
SOURce1:BB:EUTRa:DL:CA:STATE 1
SOURce1:BB:EUTRa:DL:USER1:ULCA0:STATE 1
SOURce1:BB:EUTRa:DL:USER1:ULCA1:STATE 1
```

Options:

R&S SMM-K85

Manual operation: See ["UL Carriers Configuration"](#) on page 134

[[:SOURce<hw>]:BB:EUTRa:DL:USER<ch>:APM:CELL <SelCompCar>

Sets the cell the antenna port mapping is related to, if a carrier aggregation is enabled.

Parameters:

<SelCompCar> PC0 | SC1 | SC2 | SC3 | SC4
 *RST: PC0

Example:

```
:SOURce1:BB:EUTRa:DL:USER1:APM:CELL?
```

Manual operation: See ["Cell"](#) on page 218

[[:SOURce<hw>]:BB:EUTRa:DL:USER<ch>:APM:CBCI <CbConstIdx>

Defines whether the codebook index is set globally or per subframe.

Parameters:

<CbConstIdx> 1 | ON | 0 | OFF

Manual operation: See ["Constant Codebook Index"](#) on page 217

[[:SOURce<hw>]:BB:EUTRa:DL:USER<ch>:APM:CBUA <CbUseAlt>

Applies the enhanced 4 Tx codebook.

Parameters:

<CbUseAlt> 1 | ON | 0 | OFF

OFF

The normal codebook is used.

ON

Applied is the enhanced 4Tx codebook.

*RST: 0

Example:

```
:SCONfiguration:APPLY
:SCONfiguration:FADing MIMO2X4X4
:SCONfiguration:BASeband:SOURce COUP
:SCONfiguration:APPLY

:ENTity1:SOURce1:BB:EUTRa:DL:MIMO:CONFIguration TX4
:ENTity1:SOURce1:BB:EUTRa:DL:USER1:CELL0:TXM M10
:ENTity1:SOURce1:BB:EUTRa:DL:USER1:APM:MODE CB
:ENTity1:SOURce1:BB:EUTRa:DL:USER1:APM:CBCI 0
:ENTity1:SOURce1:BB:EUTRa:DL:USER1:APM:CBUA 1

:ENTity1:SOURce1:BB:EUTRa:DL:SUBF0:ALLoc2:CW1:PRECOding:CBINdex2 1
:ENTity1:SOURce1:BB:EUTRa:DL:CELL0:SUBF0:ALLoc2:PUSCh:PRECOding:CBUA 1
```

Options: R&S SMM-K113

Manual operation: See ["Use Alternative Codebooks"](#) on page 218

**[:SOURce<hw>] :BB:EUTRa:DL:USER<ch> :APM:CBINdex[<dir>]
<CodeBookIndex>**

Sets the codebook index for mapping mode Codebook.

Parameters:

<CodeBookIndex> integer
Range: 0 to 15
*RST: 0

Manual operation: See ["Codebook Index/Codebook Index 2"](#) on page 218

[:SOURce<hw>] :BB:EUTRa:DL:USER<ch> :APM:MAPCOordinates <MapCoord>

Switches between the Cartesian (Real/Imag.) and Cylindrical (Magn./Phase) coordinates representation.

Parameters:

<MapCoord> CARTesian | CYLindrical
*RST: CARTesian

Options: R&S SMM-K84

Manual operation: See ["Mapping Coordinates"](#) on page 218

```
[ :SOURce<hw>]:BB:EUTRa:DL:USER<ch>:APM:MODE <AntPortMap>
```

Defines the antenna port mapping method.

Parameters:

```
<AntPortMap>      CB | RCB | FW
                   CB
                   Codebook
                   RCB
                   Random codebook
                   FW
                   Fixed weight
                   *RST:      FW
```

Manual operation: See "[Antenna Port Mapping](#)" on page 217

```
[ :SOURce<hw>]:BB:EUTRa:DL:USER<ch>:APM[:LAYer<user>]:AP<dir0>:
      BB<st0>:REAL <AntPortMapData>
```

Defines the mapping of the antenna ports to the physical antennas.

Suffix:

```
<dir0>            5 | 7 to 14
                  antenna port
```

Parameters:

```
<AntPortMapData> float
                  The REAL (Magnitude) and IMAGinary (Phase) values are
                  interdependent. Their value ranges change depending on each
                  other and so that the resulting complex value is as follows:
                  |REAL+j*IMAGinary| ≤ 1
                  Otherwise, the values are normalized to Magnitude = 1.
                  Range:      -1 to 360
                  Increment:  0.001
                  *RST:      dynamic
```

Manual operation: See "[Mapping table](#)" on page 218

```
[ :SOURce<hw>]:BB:EUTRa:DL:USER<ch>:APM[:LAYer<user>]:AP<dir0>:
      BB<st0>:IMAGinary <AntPortMapData>
```

Defines the mapping of the antenna ports to the physical antennas.

Suffix:

```
<dir0>            5 | 7 to 14
                  antenna port
```

Parameters:**<AntPortMapData>** float

The REAL (Magnitude) and IMAGinary (Phase) values are interdependent. Their value ranges change depending on each other and so that the resulting complex value is as follows:

$$|\text{REAL} + j * \text{IMAGinary}| \leq 1$$

Otherwise, the values are normalized to Magnitude = 1.

Range: -1 to 360

Increment: 0.001

*RST: 0

Manual operation: See "[Mapping table](#)" on page 218**[:SOURce<hw>] : BB : EUTRa : DL : USER<ch> : CCODing : STATE <State>**

Sets the channel coding for all allocations belonging to the selected user.

Parameters:**<State>** 1 | ON | 0 | OFF

*RST: OFF

Example:

BB : EUTR : DL : USER2 : CCOD : STAT ON

Enables channel coding for the allocations belonging to user 2.

Manual operation: See "[Channel Coding State](#)" on page 135**[:SOURce<hw>] : BB : EUTRa : DL : USER<ch> : UEID <Ueid>**

Sets the user equipment ID.

Parameters:**<Ueid>** integer

Range: 0 to 65535

*RST: 0

Example:

BB : EUTR : DL : USER2 : UEID 3308

Sets the UE ID.

Manual operation: See "[UE ID](#)" on page 135**[:SOURce<hw>] : BB : EUTRa : DL : USER<ch> : DATA <Data>**

Selects the data source for the selected user configuration.

Parameters:**<Data>** PN9 | PN11 | PN15 | PN16 | PN20 | PN21 | PN23 | PATTErn | DLISt | ZERO | ONE

*RST: PN9

Example:

```
SOURce1:BB:EUTRa:USER0:DATA PN23
// file lte_datalist.dm_iqd must exist in the default directory
SOURce1:BB:EUTRa:USER2:DATA DLISt
SOURce1:BB:EUTRa:USER2:LIST "/var/user/lte_datalist.dm_iqd"
SOURce1:BB:EUTRa:USER4:DATA PATTern
SOURce1:BB:EUTRa:USER4:PATTern #H1C4A9,17
```

Manual operation: See ["Data Source, DList/Pattern"](#) on page 135

[:SOURce<hw>]:BB:EUTRa:DL:USER<ch>:DSElect <DSelect>

Selects an existing data list file from the default directory or from the specific directory.

Parameters:

<DSelect> string
 File name incl. file extension or complete file path

Example: See [\[:SOURce<hw>\]:BB:EUTRa:DL:USER<ch>:DATA](#)
 on page 732.

Manual operation: See ["Data Source, DList/Pattern"](#) on page 135

[:SOURce<hw>]:BB:EUTRa:DL:USER<ch>:PATTern <Pattern>, <BitCount>

Sets a bit pattern as data source.

Parameters:

<Pattern> numeric
 *RST: #H0

<BitCount> integer
 Range: 1 to 64
 *RST: 1

Example: See [\[:SOURce<hw>\]:BB:EUTRa:DL:USER<ch>:DATA](#)
 on page 732.

Manual operation: See ["Data Source, DList/Pattern"](#) on page 135

[:SOURce<hw>]:BB:EUTRa:DL:USER<ch>:INITpattern <PatternInit>

Selects the starting seed for data sources for the PDSCH allocation.

Parameters:

<PatternInit> integer
 Range: 0 to #H7ffff
 *RST: 1

Example:

```
SOURce1:BB:EUTRa:USER0:DATA PATTern
SOURce1:BB:EUTRa:USER0:PATTern #H1C4A9,17
SOURce1:BB:EUTRa:USER0:INITpattern #H1111
```

Manual operation: See ["Data Source Init"](#) on page 136

[:SOURCE<hw>]:BB:EUTRa:DL:USER<ch>:EIMTarnti <EIMTARnti>

Sets the dedicated eIMTA-RNTI.

Parameters:

<EIMTARnti> integer
 Range: 1 to 65523
 *RST: 1

Example:

```
SOURCE1:BB:EUTRa:DUPLexing TDD
SOURCE1:BB:EUTRa:LINK DOWN
SOURCE1:BB:EUTRa:DL:USER1:EIMTarnti 10
```

Options: R&S SMM-K113

Manual operation: See "[eIMTA-RNTI](#)" on page 136

[:SOURCE<hw>]:BB:EUTRa:DL:USER<ch>:PA <Power>

Sets PDSCH power factor according to [TS 36.213](#), chapter 5.2.

Parameters:

<Power> -6.02 | -4.77 | -3.01 | -1.77 | 0.97 | 2.04 | 3.01 | 0
 *RST: 0

Example:

```
BB:EUTRa:DL:USER2:PA 2.04
Selects the P_A
```

Manual operation: See "[P_A](#)" on page 136

[:SOURCE<hw>]:BB:EUTRa:DL:USER<ch>:ASRS:STATE <CuApSrsState>

Enables/disables an aperiodic transmission of SRS for the selected user.

Parameters:

<CuApSrsState> 1 | ON | 0 | OFF
 *RST: 0

Example:

```
SOURCE1:BB:EUTRa:DL:USER2:ASRS:STATE ON
```

Manual operation: See "[Aperiodic SRS State](#)" on page 136

[:SOURCE<hw>]:BB:EUTRa:DL:USER<ch>:CAW:STATE <CuCsiAware>

Enables/disables the CSI awareness for the selected user.

Parameters:

<CuCsiAware> OFF | ON | 1 | 0
 *RST: OFF

Example:

See [Example"Enabling a CSI-RS transmission"](#) on page 630

Manual operation: See "[CSI Awareness State](#)" on page 136

[:SOURce<hw>]:BB:EUTRa:DL:USER<ch>:CELL<st0>:MCS <McsTable>

Defines which of the tables defined in [TS 36.213](#) is used to specify the used modulation and coding scheme.

Parameters:

<McsTable> 0 | OFF | T1 | 1 | ON | T2 | T3 | T4
 0|OFF|T1
 Table 7.1.7.1-1
 1|ON|T2
 Table 7.1.7.1-1A
 T3
 Table 7.1.7.1-1B
 T4
 Table 7.1.7.1-1C
 *RST: 0

Example: SOURce1:BB:EUTRa:DL:USER1:CELL0:MCS T1

Options: T1|T2 require R&S SMM-K113
 T3|T4 requireR&S SMM-K119

Manual operation: See "[MSC Table](#)" on page 137

[:SOURce<hw>]:BB:EUTRa:DL:USER<ch>:CELL<st0>:TBAL <TBSAltIndex>

Sets the which of the transport block size (TBS) tables defined in [TS 36.213](#) is used.

Parameters:

<TBSAltIndex> 0 | OFF | T1 | 1 | ON | T2 | T3 | T4
 0|OFF|T1 ="TBS Alt. Index = 0"
 1|ON|T2 ="TBS Alt. Index = 1"
 T3 = "TBS Alt. Index = 2"
 T3 = "TBS Alt. Index = 3"
 *RST: 0

Example: SOURce1:BB:EUTRa:DL:USER1:CELL0:TBAL T1

Options: T1|T2 require R&S SMM-K113
 T3|T4 requireR&S SMM-K119

Manual operation: See "[TBS Alt. Index](#)" on page 137

[:SOURce<hw>]:BB:EUTRa:DL:USER<ch>:MCSTwo:STATE <McsTable2Old>

This command is supported for backwards compatibility. Use [\[:SOURce<hw>\]:BB:EUTRa:DL:USER<ch>:CELL<st0>:MCS](#) on page 735 instead.

Parameters:

<McsTable2Old> 1 | ON | 0 | OFF
 *RST: 0

Options: R&S SMM-K113

[:SOURce<hw>]:BB:EUTRa:DL:USER<ch>:TALTindex:STATe <TBSAltIndexOld>

This command is supported for backwards compatibility. Use `[:SOURce<hw>] :BB:EUTRa:DL:USER<ch>:CELL<st0>:TBAL` on page 735 instead.

Parameters:

<TBSAltIndexOld> 1 | ON | 0 | OFF
*RST: 0

Options: R&S SMM-K113

[:SOURce<hw>]:BB:EUTRa:DL:USER<ch>:CELL<st0>:DMRS:STATe <DmrsAltTable>

Sets the value of the higher-layer parameter `dMrs-tableAlt`.

Parameters:

<DmrsAltTable> 1 | ON | 0 | OFF
*RST: 0

Example:

```
SOURce1:BB:EUTRa:DL:USER1:CELL0:TXM TM10
SOURce1:BB:EUTRa:DL:USER1:CELL0:DMRS:STATe 1
```

Options: R&S SMM-K119

Manual operation: See "[DMRS Alt Table](#)" on page 137

[:SOURce<hw>]:BB:EUTRa:DL:USER<ch>:CELL<st0>:SEOL:STATe <SemiOpenLoop>

Sets the value of the higher-layer parameter `semiOpenLoop`.

Parameters:

<SemiOpenLoop> 1 | ON | 0 | OFF
*RST: 0

Example:

```
SOURce1:BB:EUTRa:DL:USER1:CELL0:TXM TM10
SOURce1:BB:EUTRa:DL:USER1:CELL0:SEOL:STATe 1
```

Options: R&S SMM-K119

Manual operation: See "[Semi Open Loop](#)" on page 138

[:SOURce<hw>]:BB:EUTRa:DL:USER<ch>:STHP:STATe <State>

Sets if NB-IoT UEs are capable of understanding the HARQ process bit.

Parameters:

<State> 1 | ON | 0 | OFF
*RST: 0

Example:

```
SOURce1:BB:EUTRa:DL:USER1:RELease NOIT
SOURce1:BB:EUTRa:DL:USER1:STHP:STATe 1
...
SOURce1:BB:EUTRa:DL:NIOT:DCI:ALLoc0:USER USER1
SOURce1:BB:EUTRa:DL:NIOT:DCI:ALLoc0:HPNMBer 1
```

Example: See [Example "DCI format N0 configuration"](#) on page 802.

Options: R&S SMM-K115
1|ON requires R&S SMM-K143

Manual operation: See ["Support two HARQ Processes"](#) on page 138

[:SOURce<hw>]:BB:EUTRa:DL:USER<ch>:SCRambling:STATe <State>

Enables/disables scrambling for all allocations belonging to the selected user.

Parameters:

<State> 1 | ON | 0 | OFF
*RST: ON

Example:

```
SOUR:BB:EUTR:DL:USER3:SCR:STAT OFF
// Disables scrambling for allocations belonging to user 3

SOUR:BB:EUTR:DL:SUBF0:ALL4:CW:DATA USER3
SOUR:BB:EUTR:DL:SUBF0:ALL5:CW:DATA USER3
SOUR:BB:EUTR:DL:SUBF0:ALL4:CW:SCR:STAT?
// 0
SOUR:BB:EUTR:DL:SUBF0:ALL5:CW:SCR:STAT?
// 0
```

Manual operation: See ["Scrambling State"](#) on page 153

[:SOURce<hw>]:BB:EUTRa:DL:USER<ch>:SCRambling:CELL<st>:DMRS:USE <Use>

Defines how the DMRS scrambling sequence is initialized.

Parameters:

<Use> 1 | ON | 0 | OFF
OFF
DRMS sequence is generated with the variable $n_{ID} = N_{ID}^{cell}$.
ON
Used are two variable $n_{ID} = n_{ID}^{DMRS,i}$ set with the commands
[\[:SOURce<hw>\]:BB:EUTRa:DL:USER<ch>:SCRambling:CELL<st>:DMRS:ID1 | ID2](#)

Example:

```
SOURce1:BB:EUTRa:DL:MIMO:CONFIguration TX4
SOURce1:BB:EUTRa:DL:USER1:TXM M10
SOURce1:BB:EUTRa:DL:USER1:SCRambling:CELL0:DMRS:USE 1
SOURce1:BB:EUTRa:DL:USER1:SCRambling:CELL0:DMRS:ID1 100
SOURce1:BB:EUTRa:DL:USER1:SCRambling:CELL0:DMRS:ID1 220
SOURce1:BB:EUTRa:DL:USER1:SCRambling:CELL0:CSI:USE 1
SOURce1:BB:EUTRa:DL:USER1:SCRambling:CELL0:CSI:IDENT 100
```

Options: R&S SMM-K112

Manual operation: See ["Use DMRS Scrambling Identities"](#) on page 153

```
[:SOURce<hw>]:BB:EUTRa:DL:USER<ch>:SCRambling:CELL<st>:DMRS:ID1
<Ident>
[:SOURce<hw>]:BB:EUTRa:DL:USER<ch>:SCRambling:CELL<st>:DMRS:ID2
<Ident>
```

Sets the DMRS scrambling identity.

Parameters:

<Ident>	integer
Range:	0 to 503
*RST:	0

Example: See [\[:SOURce<hw>\]:BB:EUTRa:DL:USER<ch>:SCRambling:CELL<st>:DMRS:USE](#) on page 737.

Options: R&S SMM-K112

Manual operation: See ["DMRS Scrambling Identity 1/2"](#) on page 153

10.22 EPDCCH

Option: R&S SMM-K112

Example: Configuring EPDCCH transmission

```

SOURCE1:BB:EUTRa:DUPLexing FDD
SOURCE1:BB:EUTRa:LINK DOWN
SOURCE1:BB:EUTRa:DL:CONF:MODE AUTO
// EPDCCH cannot be activated in manual mode

SOURCE1:BB:EUTRa:DL:USER1:EPDCch1:SET1:STATe 1
SOURCE1:BB:EUTRa:DL:USER1:EPDCch1:SET1:TTYP LOC
SOURCE1:BB:EUTRa:DL:USER1:EPDCch1:SET1:PRBS PRB2
SOURCE1:BB:EUTRa:DL:USER1:EPDCch1:SET1:RBA 1200
SOURCE1:BB:EUTRa:DL:USER1:EPDCch1:SET1:NID 100
SOURCE1:BB:EUTRa:DL:USER1:EPDCch1:SET1:PWR 0
SOURCE1:BB:EUTRa:DL:USER1:EPDCch1:STAT 1

SOURCE1:BB:EUTRa:DL:SUBF0:ENCC:PDCCh:EXTC:ITEM0:USER USER1
SOURCE1:BB:EUTRa:DL:SUBF0:ENCC:PDCCh:EXTC:ITEM0:PDCChType EPD1
SOURCE1:BB:EUTRa:DL:SUBF0:ENCC:PDCCh:EXTC:ITEM0:DCIFmt F1A
SOURCE1:BB:EUTRa:DL:SUBF0:ENCC:PDCCh:EXTC:ITEM0:SESPace?
// UE
SOURCE1:BB:EUTRa:DL:SUBF0:ENCC:PDCCh:EXTC:ITEM0:PFMT 2
SOURCE1:BB:EUTRa:DL:SUBF0:ENCC:PDCCh:EXTC:ITEM0:NCCes?
// 2
SOURCE1:BB:EUTRa:DL:SUBF0:ENCC:PDCCh:EXTC:ITEM0:CINDEX 20
SOURCE1:BB:EUTRa:DL:SUBF0:ENCC:PDCCh:EXTC:ITEM0:NDCCes?
// 4
SOURCE1:BB:EUTRa:DL:SUBF0:ENCC:PDCCh:EXTC:ITEM0:CONFLict?
// 0

SOURCE1:BB:EUTRa:DL:SUBF0:ALLoc2:CW1:MODulation?
// QPSK
SOURCE1:BB:EUTRa:DL:SUBF0:ALLoc2:CW1:DATA?
// USER1
SOURCE1:BB:EUTRa:DL:SUBF0:ALLoc2:CW1:RBCount?
// AUTO
SOURCE1:BB:EUTRa:DL:SUBF0:ALLoc2:CW1:RBOffset?
// AUTO
SOURCE1:BB:EUTRa:DL:SUBF0:ALLoc2:CW1:CONType?
// EPD1
SOURCE1:BB:EUTRa:DL:SUBF0:ALLoc2:CW1:STATe?
// 1

[:SOURCE<hw>]:BB:EUTRa:DL:USER<ch>:EPDCch:CELL<st0>:STATe..... 740
[:SOURCE<hw>]:BB:EUTRa:DL:USER<ch>:EPDCch:CELL<st0>:SET<dir>:STATe..... 740
[:SOURCE<hw>]:BB:EUTRa:DL:USER<ch>:EPDCch:CELL<st0>:SET<dir>:TTYP..... 740
[:SOURCE<hw>]:BB:EUTRa:DL:USER<ch>:EPDCch:CELL<st0>:SET<dir>:PRBS..... 741
[:SOURCE<hw>]:BB:EUTRa:DL:USER<ch>:EPDCch:CELL<st0>:SET<dir>:RBA..... 741
[:SOURCE<hw>]:BB:EUTRa:DL:USER<ch>:EPDCch:CELL<st0>:SET<dir>:NID..... 741
[:SOURCE<hw>]:BB:EUTRa:DL:USER<ch>:EPDCch:CELL<st0>:SET<dir>:POWER..... 742

```

[:SOURCE<hw>]:BB:EUTRa:DL:USER<ch>:EPDCch:CELL<st0>:STATE <State>

Enables the EPDCCH transmission for the select user and component carrier.

Suffix:

<dir> 1|2
EPDCCH set

Parameters:

<State> 1 | ON | 0 | OFF
*RST: 0

Example: See [Example"Configuring EPDCCH transmission"](#) on page 739.

Example: Option:R&S SMM-K115
See [Example"Configuring the MPDCCH sets"](#) on page 815.

Manual operation: See ["Activate EPDCCH"](#) on page 150

[:SOURCE<hw>]:BB:EUTRa:DL:USER<ch>:EPDCch:CELL<st0>:SET<dir>:STATE <State>

Enables the EPDCCH set.

Suffix:

<dir> 1|2
EPDCCH set

Parameters:

<State> 1 | ON | 0 | OFF
*RST: 0

Example: See [Example"Configuring EPDCCH transmission"](#) on page 739.

Example: Option:R&S SMM-K115
See [Example"Configuring the MPDCCH sets"](#) on page 815.

Manual operation: See ["Set 1/2 State"](#) on page 150

[:SOURCE<hw>]:BB:EUTRa:DL:USER<ch>:EPDCch:CELL<st0>:SET<dir>:TTYP <TransType>

Select the EPDCCH transmission type.

Suffix:

<dir> 1|2
EPDCCH set

Parameters:

<TransType> LOCALized | DISTributed
*RST: LOCALized

Example: See [Example"Configuring EPDCCH transmission"](#) on page 739.

Example: Option:R&S SMM-K115
See [Example"Configuring the MPDCCH sets"](#) on page 815.

Manual operation: See ["Transmission Type"](#) on page 150

[:SOURCE<hw>]:BB:EUTRa:DL:USER<ch>:EPDCch:CELL<st0>:SET<dir>:PRBS
<NumPRBs>

Sets the number of used physical resource block (PRB) pairs.

Suffix:
<dir> 1|2
EPDCCH set

Parameters:
<NumPRBs> PRB2 | PRB4 | PRB8
*RST: PRB2

Example: See [Example"Configuring EPDCCH transmission"](#) on page 739.

Example: Option:R&S SMM-K115
See [Example"Configuring the MPDCCH sets"](#) on page 815.

Manual operation: See ["Number of PRB Pairs"](#) on page 150

[:SOURCE<hw>]:BB:EUTRa:DL:USER<ch>:EPDCch:CELL<st0>:SET<dir>:RBA
<RBA>

Defines the resource blocks used for the EPDCCH transmission.

Suffix:
<dir> 1|2
EPDCCH set

Parameters:
<RBA> integer
Range: 0 to 1000
*RST: 0

Example: See [Example"Configuring EPDCCH transmission"](#) on page 739.

Example: Option:R&S SMM-K115
See [Example"Configuring the MPDCCH sets"](#) on page 815.

Manual operation: See ["Resource Block Assignment"](#) on page 151

[:SOURCE<hw>]:BB:EUTRa:DL:USER<ch>:EPDCch:CELL<st0>:SET<dir>:NID
<EpdchId>

Sets the identifier $n_{ID,m}^{EPDCCH}$ used to calculate the UE-specific scrambling sequence.

Suffix:
<dir> 1|2
EPDCCH set

Parameters:

<EpdccId> integer
 Range: 0 to 503
 *RST: 0

Example: See [Example"Configuring EPDCCH transmission"](#) on page 739.

Example: Option:R&S SMM-K115
 See [Example"Configuring the MPDCCH sets"](#) on page 815.

Manual operation: See ["N^EPDCCH_ID"](#) on page 151

[:SOURce<hw>]:BB:EUTRa:DL:USER<ch>:EPDCch:CELL<st0>:SET<dir>:POWer
<RelPower>

Sets the power of the EPDCCH allocations relative to the power of the reference signals.

See [\[:SOURce<hw>\]:BB:EUTRa:DL:REFSig:POWer](#) on page 583.

Suffix:

<dir> 1|2
 EPDCCH set

Parameters:

<RelPower> float
 Range: -80 to 10
 Increment: 0.01
 *RST: 0

Example: See [Example"Configuring EPDCCH transmission"](#) on page 739.

Example: Option:R&S SMM-K115
 See [Example"Configuring the MPDCCH sets"](#) on page 815.

Manual operation: See ["Relative EPDCCH Power"](#) on page 151

10.23 Dummy data configuration

[:SOURce<hw>]:BB:EUTRa:DL:DUMD:MODulation	742
[:SOURce<hw>]:BB:EUTRa:DL:DUMD:POWer	743
[:SOURce<hw>]:BB:EUTRa:DL:DUMD:DATA	743
[:SOURce<hw>]:BB:EUTRa:DL:DUMD:DSElect	743
[:SOURce<hw>]:BB:EUTRa:DL:DUMD:PATtern	744
[:SOURce<hw>]:BB:EUTRa:DL:DUMD:OPSubframes	744

[:SOURce<hw>]:BB:EUTRa:DL:DUMD:MODulation <Modulation>

Selects modulation for dummy data.

Parameters:
 <Modulation> QPSK | QAM16 | QAM64 | QAM256 | QAM1024
 *RST: QPSK

Example: BB:EUTRa:DL:DUMD:MOD QAM16
 16QAM is selected as modulation for dummy data.

Options: QAM256 requires R&S SMM-K113
 QAM1024 requires R&S SMM-K119

Manual operation: See "[Modulation](#)" on page 129

[:SOURce<hw>]:BB:EUTRa:DL:DUMD:POWer <Power>

Sets the power for dummy data.

Parameters:
 <Power> float
 Range: -80 to 10
 Increment: 0.001
 *RST: 0

Example: BB:EUTRa:DL:DUMD:POWer 10.00
 Sets the power for dummy data to 10 dB.

Manual operation: See "[Power \(Dummy Data\)](#)" on page 130

[:SOURce<hw>]:BB:EUTRa:DL:DUMD:DATA <Data>

Selects the data source for dummy data.

Parameters:
 <Data> PN9 | PN11 | PN15 | PN16 | PN20 | PN21 | PN23 | PATtern |
 DLIS | ZERO | ONE
 *RST: PN9

Example: BB:EUTRa:DL:DUMD:DATA PN9
 PN9 is selected as data source for dummy data.

Manual operation: See "[Data Source](#)" on page 129

[:SOURce<hw>]:BB:EUTRa:DL:DUMD:DSElect <Filename>

Selects an existing data list file from the default directory or from the specific directory.

Parameters:
 <Filename> string
 Filename incl. file extension or complete file path

Example: SOURce1:BB:EUTRa:DL:DUMD:DATA DLIS
 SOURce1:BB:EUTRa:DL:DUMD:DSElect "/var/user/temp/lte_dl.dm_iqd"

Manual operation: See "[Data Source](#)" on page 129

```
[ :SOURce<hw>]:BB:EUTRa:DL:DUMD:PATtern <Pattern>, <BitCount>
```

Sets the bit pattern.

Parameters:

```
<Pattern>          <bit pattern>
                   *RST:      #H0

<BitCount>        integer
                   Range:     1 to 64
                   *RST:      1
```

Example: SOURce1:BB:EUTRa:DL:DUMD:PATtern #H1E,8

Manual operation: See "[Data Source](#)" on page 129

```
[ :SOURce<hw>]:BB:EUTRa:DL:DUMD:OPSubframes <OmitPrsSf>
```

If the OCNG is used, you can disable (omit) the OCNG transmission in the non-muted PRS subframes.

Parameters:

```
<OmitPrsSf>       1 | ON | 0 | OFF
                   *RST:      0
```

Example: SOURce1:BB:EUTRa:DL:BUR DUData
 SOURce1:BB:EUTRa:DL:PRSS:MIPattern #H2,2
 SOURce1:BB:EUTRa:DL:DUMD:OPSubframes ON

Manual operation: See "[Omit PRS Subframes](#)" on page 130

10.24 SPS configuration

```
[ :SOURce<hw>]:BB:EUTRa:DL:USER<ch>:SPS:STATe <UsrSpsState>
```

Enables SPS (semi-persistence scheduling).

Parameters:

```
<UsrSpsState>     1 | ON | 0 | OFF
                   *RST:      0
```

Example: SOURce1:BB:EUTRa:DL:USER2:SPS:STATe ON
 SOURce1:BB:EUTRa:DL:USER2:SPS:CRNTi 250
 SOURce1:BB:EUTRa:DL:USER2:SPS:SINTerval S20
 SOURce1:BB:EUTRa:DL:USER2:SPS:SACTivation 1
 SOURce1:BB:EUTRa:DL:USER2:SPS:SRElease 3

Manual operation: See "[Activate SPS](#)" on page 158

[:SOURce<hw>]:BB:EUTRa:DL:USER<ch>:SPS:CRNTi <UserSpsCRnti>

Sets the SPS C-RNTI parameter.

Parameters:

<UserSpsCRnti> integer
 Range: 1 to 65523
 *RST: 1

Example: See [:SOURce<hw>]:BB:EUTRa:DL:USER<ch>:SPS:STATE on page 744

Manual operation: See "SPS C-RNTI" on page 158

[:SOURce<hw>]:BB:EUTRa:DL:USER<ch>:SPS:SINterval <UserSpsInt>

Defines the SPS interval.

Parameters:

<UserSpsInt> S10 | S20 | S32 | S40 | S64 | S80 | S128 | S160 | S320 | S640
 *RST: S10

Example: See [:SOURce<hw>]:BB:EUTRa:DL:USER<ch>:SPS:STATE on page 744

Manual operation: See "SPS Interval" on page 158

[:SOURce<hw>]:BB:EUTRa:DL:USER<ch>:SPS:SACTivation <UsrSpsActSubfr>
[:SOURce<hw>]:BB:EUTRa:DL:USER<ch>:SPS:SRELease <UsrSpsRelSubfr>

Defines the start and end subframes of the semi-persistent scheduling.

Parameters:

<UsrSpsRelSubfr> integer
 Range: 0 to 65535
 *RST: 1

Example: See [:SOURce<hw>]:BB:EUTRa:DL:USER<ch>:SPS:STATE on page 744

Manual operation: See "Activation/Release Subframe No" on page 158

10.25 User equipment

[:SOURce<hw>]:BB:EUTRa:UL:UE<st>:RELease.....	747
[:SOURce<hw>]:BB:EUTRa:UL:UE<st>:DACRestart.....	747
[:SOURce<hw>]:BB:EUTRa:UL:UE<st>:ID.....	748
[:SOURce<hw>]:BB:EUTRa:UL:UE<st>:STATE.....	748
[:SOURce<hw>]:BB:EUTRa:UL:UE<st>:MODE.....	748
[:SOURce<hw>]:BB:EUTRa:UL:UE<st>:POWer.....	748
[:SOURce<hw>]:BB:EUTRa:UL:UE<st>:OCID:STATE.....	749

[SOURce<hw>]:BB:EUTRa:UL:UE<st>:CID.....	749
[SOURce<hw>]:BB:EUTRa:UL:UE<st>[:CELL<ccid>]:FRC:ALRB.....	749
[SOURce<hw>]:BB:EUTRa:UL:UE<st>[:CELL<ccid>]:FRC:MODulation?.....	750
[SOURce<hw>]:BB:EUTRa:UL:UE<st>[:CELL<ccid>]:FRC:N2DMrs.....	750
[SOURce<hw>]:BB:EUTRa:UL:UE<st>[:CELL<ccid>]:FRC:PASize?.....	750
[SOURce<hw>]:BB:EUTRa:UL:UE<st>[:CELL<ccid>]:FRC:STATE.....	751
[SOURce<hw>]:BB:EUTRa:UL:UE<st>[:CELL<ccid>]:FRC:TNOBits?.....	751
[SOURce<hw>]:BB:EUTRa:UL:UE<st>[:CELL<ccid>]:FRC:TYPE.....	751
[SOURce<hw>]:BB:EUTRa:UL:UE<st>[:CELL<ccid>]:FRC:VRBOffset.....	752
[SOURce<hw>]:BB:EUTRa:UL:UE<st>:PRACH:PRState.....	752
[SOURce<hw>]:BB:EUTRa:UL:UE<st>:PRACH:PRTT.....	753
[SOURce<hw>]:BB:EUTRa:UL:UE<st>:PRACH:PRFormat?.....	753
[SOURce<hw>]:BB:EUTRa:UL:UE<st>:PRACH:CFRames?.....	753
[SOURce<hw>]:BB:EUTRa:UL:UE<st>:PRACH:SUBF<ch0>:RBOffset.....	754
[SOURce<hw>]:BB:EUTRa:UL:UE<st>:PRACH:SUBF<ch0>:FRIndex.....	754
[SOURce<hw>]:BB:EUTRa:UL:UE<st>:PRACH:SUBF<ch0>:POWer.....	754
[SOURce<hw>]:BB:EUTRa:UL:UE<st>:PRACH:SUBF<ch0>:NCSConf.....	754
[SOURce<hw>]:BB:EUTRa:UL:UE<st>:PRACH:SUBF<ch0>:RSEquence.....	755
[SOURce<hw>]:BB:EUTRa:UL:UE<st>:PRACH:SUBF<ch0>:SINdex.....	755
[SOURce<hw>]:BB:EUTRa:UL:UE<st>:PRACH:SUBF<ch0>:DT.....	755
[SOURce<hw>]:BB:EUTRa:UL:UE<st>:PRACH:SUBF<ch0>:STATE.....	756
[SOURce<hw>]:BB:EUTRa:UL:UE<st>[:CELL<ccid>]:PUSCh:DATA.....	756
[SOURce<hw>]:BB:EUTRa:UL:UE<st>[:CELL<ccid>]:PUSCh:PATtern.....	756
[SOURce<hw>]:BB:EUTRa:UL:UE<st>[:CELL<ccid>]:PUSCh:DSElect.....	757
[SOURce<hw>]:BB:EUTRa:UL:UE<st>[:CELL<ccid>]:PUSCh:INITpattern.....	757
[SOURce<hw>]:BB:EUTRa:UL:UE<st>[:CELL<ccid>]:PUSCh:TXMode.....	757
[SOURce<hw>]:BB:EUTRa:UL:UE<st>[:CELL<ccid>]:PUSCh:NAPort.....	758
[SOURce<hw>]:BB:EUTRa:UL:UE<st>[:CELL<ccid>]:PUSCh:SCRambling:STATE.....	758
[SOURce<hw>]:BB:EUTRa:UL:UE<st>[:CELL<ccid>]:PUSCh:CCODing:STATE.....	758
[SOURce<hw>]:BB:EUTRa:UL:UE<st>[:CELL<ccid>]:PUSCh:CCODing:MODE.....	759
[SOURce<hw>]:BB:EUTRa:UL:UE<st>[:CELL<ccid>]:PUSCh:CCODing:ICQioffset.....	759
[SOURce<hw>]:BB:EUTRa:UL:UE<st>[:CELL<ccid>]:PUSCh:CCODing:IHARqoffset.....	759
[SOURce<hw>]:BB:EUTRa:UL:UE<st>[:CELL<ccid>]:PUSCh:CCODing:IRloffset.....	760
[SOURce<hw>]:BB:EUTRa:UL:UE<st>[:CELL<ccid>]:PUSCh:CCODing:OCQimin.....	760
[SOURce<hw>]:BB:EUTRa:UL:UE<st>[:CELL<ccid>]:PUSCh:UPPTs:STATE.....	760
[SOURce<hw>]:BB:EUTRa:UL:UE<st>[:CELL<ccid>]:PUSCh:UPPTs:LDMRs.....	761
[SOURce<hw>]:BB:EUTRa:UL:UE<st>[:CELL<ccid>]:PUSCh:UPPTs:NSYM.....	761
[SOURce<hw>]:BB:EUTRa:UL:UE<st>:PUCCh:F4Naport?.....	761
[SOURce<hw>]:BB:EUTRa:UL:UE<st>:PUCCh:F5Naport?.....	761
[SOURce<hw>]:BB:EUTRa:UL:UE<st>:PUCCh:F1Naport.....	762
[SOURce<hw>]:BB:EUTRa:UL:UE<st>:PUCCh:F2Naport.....	762
[SOURce<hw>]:BB:EUTRa:UL:UE<st>:PUCCh:F3Naport.....	762
[SOURce<hw>]:BB:EUTRa:UL:UE<st>[:CELL<ccid>]:REFSig:DRS:POWoffset.....	762
[SOURce<hw>]:BB:EUTRa:UL:UE<st>[:CELL<ccid>]:REFSig:DRS:DWOCc.....	762
[SOURce<hw>]:BB:EUTRa:UL:UE<st>[:CELL<ccid>]:REFSig:DRS:ENHanced.....	763
[SOURce<hw>]:BB:EUTRa:UL:UE<st>[:CELL<ccid>]:REFSig:SRS:STATE.....	763
[SOURce<hw>]:BB:EUTRa:UL:UE<st>[:CELL<ccid>]:REFSig:SRS:TT0.....	763
[SOURce<hw>]:BB:EUTRa:UL:UE<st>[:CELL<ccid>]:REFSig:SRS:POWoffset.....	764
[SOURce<hw>]:BB:EUTRa:UL:UE<st>[:CELL<ccid>]:REFSig:SRS[<srsidx>]:NAPort.....	764
[SOURce<hw>]:BB:EUTRa:UL:UE<st>[:CELL<ccid>]:REFSig:SRS[<srsidx>]:CYCShift.....	765

<code>[SOURce<hw>]:BB:EUTRa:UL:UE<st>[:CELL<ccid>]:REFSig:SRS[<srsid>]:NTRans.....</code>	765
<code>[SOURce<hw>]:BB:EUTRa:UL:UE<st>[:CELL<ccid>]:REFSig:SRS[<srsid>]:UPPTsadd....</code>	765
<code>[SOURce<hw>]:BB:EUTRa:UL:UE<st>[:CELL<ccid>]:REFSig:SRS[<srsid>]:</code>	
<code>SUBF<subfid>.....</code>	766
<code>[SOURce<hw>]:BB:EUTRa:UL:UE<st>[:CELL<ccid>]:REFSig:SRS:BHOP.....</code>	766
<code>[SOURce<hw>]:BB:EUTRa:UL:UE<st>[:CELL<ccid>]:REFSig:SRS[<srsid>]:BSRS.....</code>	766
<code>[SOURce<hw>]:BB:EUTRa:UL:UE<st>[:CELL<ccid>]:REFSig:SRS[<srsid>]:ISRS.....</code>	767
<code>[SOURce<hw>]:BB:EUTRa:UL:UE<st>[:CELL<ccid>]:REFSig:SRS[<srsid>]:TSRS?.....</code>	767
<code>[SOURce<hw>]:BB:EUTRa:UL:UE<st>[:CELL<ccid>]:REFSig:SRS[<srsid>]:TOFFset?....</code>	768
<code>[SOURce<hw>]:BB:EUTRa:UL:UE<st>[:CELL<ccid>]:REFSig:SRS[<srsid>]:TRComb.....</code>	768
<code>[SOURce<hw>]:BB:EUTRa:UL:UE<st>[:CELL<ccid>]:REFSig:SRS[<srsid>]:NKTC.....</code>	768
<code>[SOURce<hw>]:BB:EUTRa:UL:UE<st>[:CELL<ccid>]:REFSig:SRS[<srsid>]:NRRRC.....</code>	769
<code>[SOURce<hw>]:BB:EUTRa:UL:UE<st>:APMap:AP10Map:ROW<bbid>.....</code>	769
<code>[SOURce<hw>]:BB:EUTRa:UL:UE<st>:APMap:AP20Map:ROW<bbid>.....</code>	769
<code>[SOURce<hw>]:BB:EUTRa:UL:UE<st>:APMap:AP21Map:ROW<bbid>.....</code>	769
<code>[SOURce<hw>]:BB:EUTRa:UL:UE<st>:APMap:AP40Map:ROW<bbid>.....</code>	769
<code>[SOURce<hw>]:BB:EUTRa:UL:UE<st>:APMap:AP41Map:ROW<bbid>.....</code>	769
<code>[SOURce<hw>]:BB:EUTRa:UL:UE<st>:APMap:AP42Map:ROW<bbid>.....</code>	769
<code>[SOURce<hw>]:BB:EUTRa:UL:UE<st>:APMap:AP43Map:ROW<bbid>.....</code>	769
<code>[SOURce<hw>]:BB:EUTRa:UL:UE<st>:APMap:AP1000Map:ROW<bbid>.....</code>	769
<code>[SOURce<hw>]:BB:EUTRa:UL:UE<st>:APMap:AP1010Map:ROW<bbid>.....</code>	769
<code>[SOURce<hw>]:BB:EUTRa:UL:UE<st>:APMap:AP1020Map:ROW<bbid>.....</code>	769
<code>[SOURce<hw>]:BB:EUTRa:UL:UE<st>:APMap:AP100Map:ROW<bbid>.....</code>	769
<code>[SOURce<hw>]:BB:EUTRa:UL:UE<st>:APMap:AP200Map:ROW<bbid>.....</code>	769
<code>[SOURce<hw>]:BB:EUTRa:UL:UE<st>:APMap:AP201Map:ROW<bbid>.....</code>	769
<code>[SOURce<hw>]:BB:EUTRa:UL:UE<st>:CELL<dir0>:POFFset.....</code>	770

`[SOURce<hw>]:BB:EUTRa:UL:UE<st>:RELease <Release>`

Sets which LTE release version the UE supports.

Parameters:

`<Release>` R89 | LADV | EMTc | NIOT
 *RST: R89 (R&S SMM-K55) | EMTc (R&S SMM-K115)

Example:

`SOURce1:BB:EUTRa:UL:UE1:RELease LADV`

Options:

R89 requires R&S SMM-K55
 LADV requires R&S SMM-K85
 EMTc|NIOT require R&S SMM-K115

Manual operation: See "[3GPP Release](#)" on page 244

`[SOURce<hw>]:BB:EUTRa:UL:UE<st>:DACRestart <RestartState>`

If activated, the indicated values are restarted at the specified intervals.

Parameters:

`<RestartState>` 1 | ON | 0 | OFF
 *RST: 0

Example:

`SOURce1:BB:EUTRa:UL:UE1:DACRestart 1`

Manual operation: See ["Restart Data, A/N, CQI and RI Every Subframe and Codeword/Restart Data and A/N Every Subframe"](#) on page 255

[:SOURCE<hw>]:BB:EUTRa:UL:UE<st>:ID <Id>

Sets the radio network temporary identifier (RNTI) of the UE.

Parameters:

<Id> integer
 Range: 0 to 65535
 *RST: 0

Example: BB:EUTRa:UL:UE3:ID 303
 Sets the UE ID

Manual operation: See ["UE ID/n_RNTI"](#) on page 255

[:SOURCE<hw>]:BB:EUTRa:UL:UE<st>:STATE <State>

Selects the user equipment state.

Parameters:

<State> 1 | ON | 0 | OFF
 *RST: 1 (UE1); 0 (UE2 to UE7)

Example: BB:EUTRa:UL:UE2:STAT ON
 Activates UE2.

Manual operation: See ["State"](#) on page 254

[:SOURCE<hw>]:BB:EUTRa:UL:UE<st>:MODE <Mode>

Selects whether the user equipment is in standard or in PRACH mode.

Parameters:

<Mode> STD | PRACH
 *RST: STD

Example: BB:EUTRa:UL:UE:MODE STD
 Selects the standard mode for UE1.

Manual operation: See ["Mode"](#) on page 256

[:SOURCE<hw>]:BB:EUTRa:UL:UE<st>:POWER <Power>

Sets the power level of the selected UE.

Parameters:

<Power> float
 Range: -80 to 10
 Increment: 0.001
 *RST: 0

Example: BB:EUTR:UL:UE2:POW -5.0
Sets the power of UE2

Manual operation: See ["UE Power"](#) on page 255

[:SOURce<hw>]:BB:EUTRa:UL:UE<st>:OCID:STATe <OverrideCellID>

if enabled, you can set an user-defined cell ID for the selected user.

Parameters:

<OverrideCellID> 1 | ON | 0 | OFF
*RST: 0

Example: SOURce1:BB:EUTRa:LINK UP
SOURce1:BB:EUTRa:UL:CA:STATe 0
SOURce1:BB:EUTRa:UL:PLCI:CID 20

SOURce1:BB:EUTRa:UL:UE1:OCID:STATe 1
SOURce1:BB:EUTRa:UL:UE1:CID 10

Manual operation: See ["Override Cell ID"](#) on page 255

[:SOURce<hw>]:BB:EUTRa:UL:UE<st>:CID <ULUECELLID>

Sets the UE-specific cell ID.

Parameters:

<ULUECELLID> integer
Range: 0 to 503
*RST: 0

Example: See [\[:SOURce<hw>\]:BB:EUTRa:UL:UE<st>:OCID:STATe](#) on page 749.

Manual operation: See ["Cell ID"](#) on page 255

**[:SOURce<hw>]:BB:EUTRa:UL:UE<st>[:CELL<ccid>]:FRC:ALRB
<AllocResBlocks>**

Queries the number of the allocated resource blocks for the selected FRC.

Parameters:

<AllocResBlocks> integer
Range: 0 to 110
*RST: 0

Example: BB:EUTR:UL:UE2:FRC:TYPE A34
Sets the FRC
BB:EUTR:UL:UE2:FRC:ALRB?
Response: 25

Manual operation: See ["Allocated Resource Blocks"](#) on page 260

[:SOURce<hw>]:BB:EUTRa:UL:UE<st>[:CELL<ccidx>]:FRC:MODulation?

Queries the modulation for the selected FRC ([:SOURce<hw>]:BB:EUTRa:UL:UE<st>[:CELL<ccidx>]:FRC:TYPE on page 751).

Return values:

<Modulation> QPSK | QAM16 | QAM64 | QAM256
*RST: QPSK

Example:

```
BB:EUTR:UL:UE2:FRC:TYPE A34
BB:EUTR:UL:UE2:FRC:MOD?
// QPSK
```

Usage: Query only

Manual operation: See "Modulation (FRC)" on page 260

[:SOURce<hw>]:BB:EUTRa:UL:UE<st>[:CELL<ccidx>]:FRC:N2DMrs <N2Dmrs>

Sets the UE specific part of the demodulation reference signal (DMRS) index for all PUSCH allocation of the selected UE in all subframes.

Parameters:

<N2Dmrs> integer
Range: 0 to 10
*RST: 0

Example:

```
SOUR:BB:EUTR:UL:SUBF4:ALL0:PUSCH:NDMR 3
Sets the n(2)_DMRS
SOUR:BB:EUTR:UL:UE1:FRC:STAT ON
Enables FRC
SOUR:BB:EUTR:UL:UE1:FRC:N2DM 5
Sets the DMRS index for all PUSCH allocation of the selected
UE in all subframes
SOUR:BB:EUTR:UL:SUBF4:ALL0:PUSCH:N2DM?
Response: 5
```

Manual operation: See "n(2)_DMRS (FRC)" on page 261

[:SOURce<hw>]:BB:EUTRa:UL:UE<st>[:CELL<ccidx>]:FRC:PASize?

Queries the payload size for the selected FRC ([:SOURce<hw>]:BB:EUTRa:UL:UE<st>[:CELL<ccidx>]:FRC:TYPE on page 751).

Return values:

<PayloadSize> integer
Range: 0 to 2E5
*RST: 0

Example: BB:EUTR:UL:UE2:FRC:TYPE A34
Sets the FRC
BB:EUTR:UL:UE2:FRC:PAS?
Response: 2216

Usage: Query only

Manual operation: See "[Payload Size \(FRC\)](#)" on page 260

[:SOURCE<hw>]:BB:EUTRa:UL:UE<st>[:CELL<ccidx>]:FRC:STATE <State>

Enables/disables FRC configuration.

Enabling FRC configuration sets some parameters to their predefined values, i.e. several parameters are displayed as read-only. Reconfiguration of the values of this parameters is possible only after disabling the FRC configuration.

The FRC State is disabled and cannot be enabled, if a user defined cyclic prefix (BB:EUTR:UL:CPC USER) is selected.

Parameters:

<State> 1 | ON | 0 | OFF
*RST: OFF

Example: BB:EUTR:UL:UE2:FRC:STAT ON
Enables FRC

Manual operation: See "[FRC State](#)" on page 259

[:SOURCE<hw>]:BB:EUTRa:UL:UE<st>[:CELL<ccidx>]:FRC:TNOBits?

Queries the total number of physical bits available for the PUSCH allocation per sub-frame in case the PUSCH is not shortened because of SRS or because it is transmitted in a cell-specific SRS subframe.

Return values:

<TotalBitCount> integer
Range: 0 to max
*RST: 0

Example: BB:EUTR:UL:UE2:FRC:TYPE A34
Sets the FRC
BB:EUTR:UL:UE2:FRC:TNOB?
Response: 7200

Usage: Query only

Manual operation: See "[Physical Bits Per Subframe \(Unshortened PUSCH\)](#)" on page 261

[:SOURCE<hw>]:BB:EUTRa:UL:UE<st>[:CELL<ccidx>]:FRC:TYPE <Type>

Selects a predefined fixed reference channel according to [TS 36.141](#) and [TS 36.521](#).

Parameters:

<Type> A11 | A12 | A13 | A14 | A15 | A21 | A22 | A23 | A31 | A32 | A33 |
 A34 | A35 | A36 | A37 | A41 | A42 | A43 | A44 | A45 | A46 | A47 |
 A48 | A51 | A52 | A53 | A54 | A55 | A56 | A57 | A71 | A72 | A73 |
 A74 | A75 | A76 | A81 | A82 | A83 | A84 | A85 | A86 | UE11 |
 UE12 | UE21 | UE22 | UE3 | A16 | A17 | A121 | A122 | A123 |
 A124 | A125 | A126 | A131 | A132 | A133 | A134 | A135 | A136 |
 A171 | A172 | A173 | A174 | A175 | A176 | A181 | A182 | A183 |
 A184 | A185 | A186 | A191 | A192 | A193 | A194 | A195 | A196 |
 A211 | A212 | A213 | A214 | A215 | A216 | A221 | A222 | A223 |
 A224

*RST: A11

Example:

BB:EUTR:UL:UE2:FRC:TYPE A34

Options:

A171|A172|A173|A174|A175|A176|A181|A182|A183|A184|A185|
 A186|A191|A192|A193|A194|A195|A196|A211|A212|A213|A214|
 A215|A216|A221|A222|A223|A224 require R&S SMM-K119

Manual operation: See "FRC" on page 259

[:SOURce<hw>]:BB:EUTRa:UL:UE<st>[:CELL<ccid>]:FRC:VRBoffset
 <VrbOffset>

Sets the virtual resource block (VRB) offset for all PUSCH allocation of the selected UE in all subframes.

Parameters:

<VrbOffset> integer
 Range: 0 to dynamic
 *RST: 2

Example:

SOUR:BB:EUTR:UL:SUBF4:ALL0:VRB 6
 SOUR:BB:EUTR:UL:UE1:FRC:STAT ON
 SOUR:BB:EUTR:UL:UE1:FRC:VRB 3
 SOUR:BB:EUTR:UL:SUBF4:ALL0:VRB?
 Response: 3

Manual operation: See "Offset VRB (FRC)" on page 261

[:SOURce<hw>]:BB:EUTRa:UL:UE<st>:PRACH:PRSTate <State>

Activates Power Ramping for the PRACH preamble. The start and the end of the preamble is cyclically extended and multiplied with a ramping function (\sin^2).

Parameters:

<State> 1 | ON | 0 | OFF
 *RST: OFF

Example:

BB:EUTR:UL:UE1:MODE PRAC
 BB:EUTR:UL:UE1:PRAC:PRST ON

Manual operation: See "State PRACH Power Ramping" on page 307

[[:SOURce<hw>]:BB:EUTRa:UL:UE<st>:PRACH:PRTT <TransitionTime>

Defines the transition time from beginning of the extended preamble to the start of the preamble itself.

Parameters:

<TransitionTime> float
 Range: 0 to 3E-5
 Increment: 1E-7
 *RST: 2E-5
 Default unit: s

Example: BB:EUTR:UL:UE1:MODE PRAC
 BB:EUTR:UL:UE1:PRAC:PRST ON
 BB:EUTR:UL:UE1:PRAC:PRTT 15us

Manual operation: See "[Transition Time](#)" on page 307

[[:SOURce<hw>]:BB:EUTRa:UL:UE<st>:PRACH:PRFormat?

Queries the preamble format.

Return values:

<PreaFormat> integer
 Range: 0 to 3
 *RST: 0

Example: BB:EUTR:UL:UE1:PRAC:PRF?
 Queries the preamble format.

Usage: Query only

Manual operation: See "[Preamble Format \(Burst Format\)](#)" on page 309

[[:SOURce<hw>]:BB:EUTRa:UL:UE<st>:PRACH:CFRames?

Queries the number of configurable frames.

Return values:

<ConfigFrameCoun> integer
 Range: 1 to 10
 *RST: 1

Example: BB:EUTR:UL:UE1:PRAC:CRF?
 Queries the number of frames

Usage: Query only

Manual operation: See "[Number of Configurable Frames](#)" on page 309

[:SOURce<hw>]:BB:EUTRa:UL:UE<st>:PRACH:SUBF<ch0>:RBOffset <RbOffset>

Queries the starting RB, as set with the command `[:SOURce<hw>]:BB:EUTRa:UL:PRACH:FOFFset`.

Parameters:

<RbOffset> integer
 Range: 0 to 109
 *RST: 0

Example: BB:EUTR:UL:UE1:PRAC:SUBF2:RBOF?
 Queries the RB offset.

Manual operation: See "RB Offset" on page 309

[:SOURce<hw>]:BB:EUTRa:UL:UE<st>:PRACH:SUBF<ch0>:FRINdex <FreqResIndex>

(enabled in TDD duplexing mode only)

Sets the frequency resource index f_{RA} for the selected subframe.

Parameters:

<FreqResIndex> integer
 Range: 0 to dynamic
 *RST: 0

Example: BB:EUTR:UL:UE1:PRAC:SUBF2:FRIN 2
 Sets the frequency resource index

Manual operation: See "Frequency Resource Index" on page 309

[:SOURce<hw>]:BB:EUTRa:UL:UE<st>:PRACH:SUBF<ch0>:POWER <Power>

Sets the PRACH power relative to the UE power. The PRACH power can be adjusted independently for every configured preamble.

Parameters:

<Power> float
 Range: -80 to 10
 Increment: 0.001
 *RST: 0

Example: BB:EUTR:UL:UE1:PRAC:SUBF2:POW -3
 Sets the power

Manual operation: See "Power" on page 310

[:SOURce<hw>]:BB:EUTRa:UL:UE<st>:PRACH:SUBF<ch0>:NCSConf <NcsConfig>

Selects the Ncs configuration of the selected subframe.

Parameters:

<NcsConfig> integer
 For details on the value range, see [Table 4-21](#).
 Range: 0 to 15
 *RST: 0

Example: BB:EUTR:UL:UE1:PRAC:SUBF2:NCSC 2
 Sets the Ncs Configuration

Manual operation: See "[Ncs Configuration](#)" on page 309

[:SOURCE<hw>]:BB:EUTRa:UL:UE<st>:PRAC:SUBF<ch0>:RSEQUENCE
 <RootSequence>

Selects the logical root sequence index for the selected subframe.

Parameters:

<RootSequence> integer
 Range: 0 to 838
 *RST: 0

Example: BB:EUTR:UL:UE1:PRAC:SUBF2:RSEQ 200
 Sets the root sequence

Manual operation: See "[Logical Root Sequence Index](#)" on page 310

[:SOURCE<hw>]:BB:EUTRa:UL:UE<st>:PRAC:SUBF<ch0>:SINDEX
 <SequenceIndex>

Selects the sequence index v.

Parameters:

<SequenceIndex> integer
 Range: 0 to 63
 *RST: 0

Example: BB:EUTR:UL:UE1:PRAC:SUBF2:SIND 30
 Sets the sequence index

Manual operation: See "[Sequence Index \(v\)](#)" on page 310

[:SOURCE<hw>]:BB:EUTRa:UL:UE<st>:PRAC:SUBF<ch0>:DT <DeltaTime>

Sets the parameter delta_t in us.

Parameters:

<DeltaTime> float
 Range: -500 to 500
 Increment: 0.01
 *RST: 0
 Default unit: us

Example: `SOURce1:BB:EUTRa:UL:UE1:PRACH:SUBF2:DT 300`

Manual operation: See "[Delta t/us](#)" on page 310

[:SOURce<hw>]:BB:EUTRa:UL:UE<st>:PRACH:SUBF<ch0>:STATe <State>

Enables/disables the PRACH for the selected subframe.

The subframes available for configuration depend on the selected PRACH configuration.

Parameters:

<State> 1 | ON | 0 | OFF
*RST: 0

Example: `BB:EUTR:UL:UE1:PRAC:SUBF2:STAT ON`
Activates PRACH in subframe 2 for UE1.

Manual operation: See "[State](#)" on page 311

[:SOURce<hw>]:BB:EUTRa:UL:UE<st>[:CELL<ccid>]:PUSCh:DATA <Data>

Selects the PUSCH data source of the selected UE. For the selected UE, this data source is used for the PUSCH channel in every subframe where this channel is configured.

Parameters:

<Data> PN9 | PN11 | PN15 | PN16 | PN20 | PN21 | PN23 | PATTErn |
DLISt | ZERO | ONE
*RST: PN9

Example: `SOURce1:BB:EUTRa:UL:UE3:PUSCh:DATA PN11`

Manual operation: See "[Data Source \(tab General\)](#)" on page 263

**[:SOURce<hw>]:BB:EUTRa:UL:UE<st>[:CELL<ccid>]:PUSCh:PATTern
<Pattern>, <BitCount>**

Sets the bit pattern.

Parameters:

<Pattern> numeric
*RST: #H0

<BitCount> integer
Range: 1 to 64
*RST: 1

Example: `BB:EUTR:UL:UE2:PUSC:DATA PATT`
`BB:EUTR:UL:UE2:PUSC:PATT #H3F,8`

Manual operation: See "[Data Source \(tab General\)](#)" on page 263

```
[ :SOURce<hw>]:BB:EUTRa:UL:UE<st>[:CELL<ccid>]:PUSCh:DSElect
<Filename>
```

Selects an existing data list file from the default directory or from the specific directory.

Parameters:

<Filename> string
 Filename incl. file extension or complete file path

Example:

```
SOURce1:BB:EUTRa:UL:UE3:PUSCh:DATA DLISt
SOURce1:BB:EUTRa:UL:UE3:PUSCh:DSElect "/var/user/lte_data_list"
```

Manual operation: See ["Data Source \(tab General\)"](#) on page 263

```
[ :SOURce<hw>]:BB:EUTRa:UL:UE<st>[:CELL<ccid>]:PUSCh:INITpattern
<PatInit>
```

Selects the starting seed for data sources for the PUSCH allocation.

Parameters:

<PatInit> integer
 Range: 1 to #H7ffff
 *RST: 1

Example:

```
SOURce1:BB:EUTRa:UL:UE0:PUSCh:DATA PATTern
SOURce1:BB:EUTRa:UL:UE0:PUSCh:PATTern #H1C4A9,17
SOURce1:BB:EUTRa:UL:UE0:PUSCh:INITpattern #HFF
```

Manual operation: See ["Initialization \(tab General\)"](#) on page 263

```
[ :SOURce<hw>]:BB:EUTRa:UL:UE<st>[:CELL<ccid>]:PUSCh:TXMode
<TxMode>
```

For LTE-A UEs, sets the PUSCH transmission mode according to [TS 36.213](#).

eMTC UEs support PUSCH transmission mode M1 only.

Parameters:

<TxMode> M1 | M2
 M1
 Spatial multiplexing not possible
 M2
 Spatial multiplexing possible
 *RST: M1

Example:

```
SOURce1:BB:EUTRa:UL:UE1:RELease LADV
SOURce1:BB:EUTRa:UL:UE1:PUSCh:TXMode M2
```

Options: R&S SMM-K85

Manual operation: See ["Transmission Mode \(tab General\)"](#) on page 263

```
[ :SOURce<hw>]:BB:EUTRa:UL:UE<st>[:CELL<ccid>]:PUSCh:NAPort
<NumAPs>
```

Sets the number of antenna ports for PUSCH transmission.

Use the command `[:SOURce<hw>]:BB:EUTRa:UL[:CELL<ccid>] [:SUBF<st0>]:ALLoc<ch0>:PUSCh:PRECoding:NAPused` on page 713 to query the number of used antenna ports.

Parameters:

```
<NumAPs>          AP1 | AP2 | AP4
*RST:             AP1
```

Example:

```
SOURce1:BB:EUTRa:UL:UE1:RELease R10
SOURce1:BB:EUTRa:UL:UE1:PUSCh:NAP AP2
SOURce1:BB:EUTRa:UL:SUBF0:ALLoc0:PUSCh:PRECoding:NAPused?
// Response: AP2
```

Options: R&S SMM-K85

Manual operation: See ["Max. Number of AP for PUSCH \(tab General\)"](#) on page 264

```
[ :SOURce<hw>]:BB:EUTRa:UL:UE<st>[:CELL<ccid>]:PUSCh:SCRambling:
STATe <State>
```

Enables/disables scrambling for all PUSCH allocations of the corresponding UE.

Parameters:

```
<State>           1 | ON | 0 | OFF
*RST:             OFF
```

Example:

```
BB:EUTRa:UL:UE2:PUSCh:SCR:STAT ON
Enables scrambling for UE2
```

Manual operation: See ["State \(PUSCH tab Scrambling\)"](#) on page 264

```
[ :SOURce<hw>]:BB:EUTRa:UL:UE<st>[:CELL<ccid>]:PUSCh:CCODing:STATe
<State>
```

Enables/disables channel coding and multiplexing of data and control information for all PUSCH allocations of the corresponding UE.

Parameters:

```
<State>           1 | ON | 0 | OFF
*RST:             OFF
```

Example:

```
BB:EUTRa:UL:UE2:PUSCh:CCOD:STAT ON
Enables channel coding for UE2
```

Manual operation: See ["State"](#) on page 265

```
[:SOURce<hw>]:BB:EUTRa:UL:UE<st>[:CELL<ccid>]:PUSCh:CCODing:MODE  
<Mode>
```

Defines the information transmitted on the PUSCH.

Parameters:

<Mode> COMBined | ULSConly | UCInly

COMBined

Control information and data are multiplexed into the PUSCH.

ULSConly

Only data is transmitted on PUSCH.

UCInly

Only uplink control information is transmitted on PUSCH.

*RST: ULSConly

Example:

```
BB:EUTR:UL:UE2:PUSC:CCOD:MODE COMB
```

Enables multiplexing of the control information (UCI) and data (UL-SCH) on the PUSCH for UE2

Manual operation: See "[Mode](#)" on page 265

```
[:SOURce<hw>]:BB:EUTRa:UL:UE<st>[:CELL<ccid>]:PUSCh:CCODing:  
ICQioffset <IcqiOffset>
```

Sets the CQI offset index for control information MCS offset determination according to 3GPP TS 36.213, chapter 8.6.3.

Parameters:

<IcqiOffset> integer

Range: 2 to 15

*RST: 2

Example:

```
BB:EUTR:UL:UE2:PUSC:CCOD:MODE COMB
```

Enables multiplexing of the control information (UCI) and data (UL-SCH) on the PUSCH for UE2

```
BB:EUTR:UL:UE2:PUSC:CCOD:ICQ 5
```

Sets the CQI offset index

Manual operation: See "[I_CQI_offset](#)" on page 265

```
[:SOURce<hw>]:BB:EUTRa:UL:UE<st>[:CELL<ccid>]:PUSCh:CCODing:  
IHARqoffset <IHArqOffset>
```

Sets the HARQ-ACK offset index for control information MCS offset determination according to [TS 36.213](#).

Parameters:

<IHArqOffset> integer

Range: 0 to 14

*RST: 0

Example:

```
// enable multiplexing of the control information (UCI) and data (UL-SCH)
BB:EUTR:UL:UE2:PUSC:CCOD:MODE COMB
// set the HARQ-ACK offset index
BB:EUTR:UL:UE2:PUSC:CCOD:IHAR 5
```

Manual operation: See "[I_HARQ_offset](#)" on page 265

**[:SOURCE<hw>]:BB:EUTRa:UL:UE<st>[:CELL<ccid>]:PUSCh:CCODing:
IRIoffset <IRIOffset>**

Sets the RI offset index for control information MCS offset determination.

Parameters:

<IRIOffset> integer
 Range: 0 to 12
 *RST: 0

Example:

```
BB:EUTR:UL:UE2:PUSC:CCOD:MODE COMB
Enables multiplexing of the control information (UCI) and data
(UL-SCH) on the PUSCH for UE2
BB:EUTR:UL:UE2:PUSC:CCOD:IRI 5
Sets the RI offset index
```

Manual operation: See "[I_RI_offset](#)" on page 265

**[:SOURCE<hw>]:BB:EUTRa:UL:UE<st>[:CELL<ccid>]:PUSCh:CCODing:
OCQimin <ChanCodOCQIMin>**

For PUSCH channel coding and multiplexing mode UCI only, sets the parameter O_CQI-Min.

Parameters:

<ChanCodOCQIMin> integer
 Range: 1 to 472
 *RST: 1

Example:

```
SOURCE1:BB:EUTRa:UL:UE1:PUSCh:CCODing:MODE UCI
SOURCE1:BB:EUTRa:UL:UE1:PUSCh:CCODing:OCQimin 7
```

Manual operation: See "[O_CQI-Min](#)" on page 265

**[:SOURCE<hw>]:BB:EUTRa:UL:UE<st>[:CELL<ccid>]:PUSCh:UPPTs:STATe
<UpPtsState>**

Enables PUSCH transmission in the UpTPS part of the special subframe.

Parameters:

<UpPtsState> 1 | ON | 0 | OFF
 *RST: 0

Example:

```
SOURce1:BB:EUTRa:DUPLexing TDD
SOURce1:BB:EUTRa:LINK UP
SOURce1:BB:EUTRa:TDD:UDConf 0
SOURce1:BB:EUTRa:TDD:SPSConf 10
SOURce1:BB:EUTRa:STATe 1

SOURce1:BB:EUTRa:UL:UE1:RELease LADV
SOURce1:BB:EUTRa:UL:UE1:STATe 1
SOURce1:BB:EUTRa:UL:UE1:CELL0:PUSCh:CCODing:STATe 1
SOURce1:BB:EUTRa:UL:UE1:CELL0:PUSCh:CCODing:UPTPs:STATe 1
SOURce1:BB:EUTRa:UL:UE1:CELL0:PUSCh:CCODing:UPTPs:LDMRs 1
SOURce1:BB:EUTRa:UL:UE1:CELL0:PUSCh:CCODing:UPTPs:NSYM 5
```

Options: R&S SMM-K119

Manual operation: See ["State"](#) on page 266

[:SOURce<hw>]:BB:EUTRa:UL:UE<st>[:CELL<ccidx>]:PUSCh:UPPTs:LDMRs
 <UpPtsLessDMRS>

If enabled, the number of used demodulation reference signals (DMRS) is reduced.

Parameters:

<UpPtsLessDMRS> 1 | ON | 0 | OFF
 *RST: 0

Example: See [\[:SOURce<hw>\]:BB:EUTRa:UL:UE<st>\[:CELL<ccidx>\]:PUSCh:UPPTs:STATe](#) on page 760.

Options: R&S SMM-K119

Manual operation: See ["Less DMRS"](#) on page 266

[:SOURce<hw>]:BB:EUTRa:UL:UE<st>[:CELL<ccidx>]:PUSCh:UPPTs:NSYM
 <UpPtsNumSym>

Sets the number of symbols used for the PUSCH transmission.

Parameters:

<UpPtsNumSym> integer
 Range: 1 to 472
 *RST: 1

Example: See [\[:SOURce<hw>\]:BB:EUTRa:UL:UE<st>\[:CELL<ccidx>\]:PUSCh:UPPTs:STATe](#) on page 760.

Options: R&S SMM-K119

Manual operation: See ["Number of Symbols"](#) on page 266

[:SOURce<hw>]:BB:EUTRa:UL:UE<st>:PUCCh:F4Naport?
[:SOURce<hw>]:BB:EUTRa:UL:UE<st>:PUCCh:F5Naport?

```
[ :SOURce<hw>]:BB:EUTRa:UL:UE<st>:PUCCh:F1Naport <NumAPs>
[:SOURce<hw>]:BB:EUTRa:UL:UE<st>:PUCCh:F2Naport <NumAPs>
[:SOURce<hw>]:BB:EUTRa:UL:UE<st>:PUCCh:F3Naport <NumAPs>
```

For LTE-A UEs, sets the number of antenna ports used for every PUCCH format transmission.

Parameters:

```
<NumAPs>          AP1 | AP2
*RST:             AP1
```

Example: See [\[:SOURce<hw>\]:BB:EUTRa:UL\[:SUBF<st0>\]:ALLoc<ch0>:PUCCh:NAPused?](#) on page 722

Options: F1Naport|F2Naport|F3Naport require R&S SMM-K85
F4Naport|F5Naport require R&S SMM-K119

Manual operation: See ["Number of Antenna Ports for PUCCH per PUCCH Format"](#) on page 257

```
[ :SOURce<hw>]:BB:EUTRa:UL:UE<st>[:CELL<ccid>]:REFSig:DRS:POWoffset
<PowerOffset>
```

Sets the power offset of the demodulation reference signal (DMRS) relative to the power level of the PUSCH/PUCCH allocation of the corresponding subframe.

Parameters:

```
<PowerOffset>    float
Range:           -80 to 10
Increment:       0.001
*RST:            0
```

Example: BB:EUTR:UL:UE2:REFS:DRS:POW -2

Manual operation: See ["DMRS Power Offset"](#) on page 267

```
[ :SOURce<hw>]:BB:EUTRa:UL:UE<st>[:CELL<ccid>]:REFSig:DRS:DWOCc
<DmrsWithOcc>
```

For Release 10 UEs, activate demodulation reference signal (DMRS) with an orthogonal cover code (OCC) for one antenna port.

Parameters:

```
<DmrsWithOcc>    1 | ON | 0 | OFF
*RST:            0
```

Example: SOURce1:BB:EUTRa:UL:UE1:RELease R10
SOURce1:BB:EUTRa:UL:UE1:REFSig:DRS:DWOCc ON

Options: R&S SMM-K85

Manual operation: See ["Activate DMRS with OCC for One Antenna Port"](#) on page 267

```
[ :SOURce<hw>]:BB:EUTRa:UL:UE<st>[:CELL<ccid>]:REFSig:DRS:ENHanced
  <DmrsEnhanced>
```

Enables enhanced DMRS.

Parameters:

```
<DmrsEnhanced> 1 | ON | 0 | OFF
*RST:          0
```

Example:

```
// enabling mapping the DMRS sequence on each second subcarrier
SOURcel:BB:EUTRa:UL:UE1:CELL0:REFSig:DRS:ENHanced 1
SOURcel:BB:EUTRa:UL:CELL0:SUBF0:ALLOcl:PUSCh:MAPPING 1
```

Manual operation: See ["Enhanced DMRS"](#) on page 268

```
[ :SOURce<hw>]:BB:EUTRa:UL:UE<st>[:CELL<ccid>]:REFSig:SRS:STATe
  <State>
```

Enables sending of SRS for the corresponding UE.

Parameters:

```
<State>         1 | ON | 0 | OFF
*RST:           OFF
```

Manual operation: See ["SRS State"](#) on page 270

```
[ :SOURce<hw>]:BB:EUTRa:UL:UE<st>[:CELL<ccid>]:REFSig:SRS:TT0
  <TType0>
```

Enables transmission of trigger type 0.

Parameters:

```
<TType0>       1 | ON | 0 | OFF
*RST:          1
```

Example:

```

:SOURcel:BB:EUTRa:LINK UP
:SOURcel:BB:EUTRa:UL:UE1:RELease LADV

:SOURcel:BB:EUTRa:UL:UE1:STAtE 1
:SOURcel:BB:EUTRa:UL:UE1:CELL0:REFSig:SRS1:STAtE 1
:SOURcel:BB:EUTRa:UL:UE1:CELL0:REFSig:SRS1:TT0 1
:SOURcel:BB:EUTRa:UL:UE1:CELL0:REFSig:SRS1:NAPort AP1
:SOURcel:BB:EUTRa:UL:UE1:CELL0:REFSig:SRS1:CYCShift 3
:SOURcel:BB:EUTRa:UL:UE1:CELL0:REFSig:SRS1:ISRS 3
:SOURcel:BB:EUTRa:UL:UE1:CELL0:REFSig:SRS1:TRComb 1
:SOURcel:BB:EUTRa:UL:UE1:CELL0:REFSig:SRS1:BHOP 2

:SOURcel:BB:EUTRa:UL:UE1:CELL0:REFSig:SRS2:NAPort AP2
:SOURcel:BB:EUTRa:UL:UE1:CELL0:REFSig:SRS2:NTRans 2
:SOURcel:BB:EUTRa:UL:UE1:CELL0:REFSig:SRS2:ISRS 1
:SOURcel:BB:EUTRa:UL:UE1:CELL0:REFSig:SRS2:SUBF1 1
:SOURcel:BB:EUTRa:UL:UE1:CELL0:REFSig:SRS2:SUBF2 3

:SOURcel:BB:EUTRa:UL:UE1:CELL0:REFSig:SRS3:NAPort AP2
:SOURcel:BB:EUTRa:UL:UE1:CELL0:REFSig:SRS3:NTRans 1

```

Options: R&S SMM-K85

Manual operation: See "[Transmit Trigger Type 0](#)" on page 270

[:SOURce<hw>]:BB:EUTRa:UL:UE<st>[:CELL<ccid>]:REFSig:SRS:POWoffset
<PowerOffset>

Sets the power offset of the Sounding Reference Signal (SRS) relative to the power of the corresponding UE.

Parameters:

<PowerOffset>	float
Range:	-80 to 10
Increment:	0.001
*RST:	0

Example: BB:EUTRa:UL:UE2:REFS:SRS:POW -2
 Sets the sounding reference symbol power offset to -2 dB.

Manual operation: See "[SRS Power Offset](#)" on page 270

[:SOURce<hw>]:BB:EUTRa:UL:UE<st>[:CELL<ccid>]:REFSig:SRS[<srsid>]:
NAPort <NumAPs>

Sets the number of antenna ports (N_{ap}) used for every SRS transmission.

Parameters:

<NumAPs>	AP1 AP2 AP4
*RST:	AP1

- Example:** See [\[:SOURce<hw>\]:BB:EUTRa:UL:UE<st>\[:CELL<ccid>\]:PUSCh:NAPort](#) on page 758
- Options:** R&S SMM-K85
- Manual operation:** See ["Number of Antenna Ports for SRS"](#) on page 271

[:SOURce<hw>]:BB:EUTRa:UL:UE<st>[:CELL<ccid>]:REFSig:SRS[<srsid>]:CYCShift <CyclicShift>

Sets the cyclic shift used for the generation of the sounding reference signal CAZAC sequence.

Parameters:
 <CyclicShift> integer
 Range: 0 to 11
 *RST: 0
 <CyclicShift> = 7 to 11 if [\[:SOURce<hw>\]:BB:EUTRa:UL:UE<st>\[:CELL<ccid>\]:REFSig:SRS\[<srsid>\]:NKTC 4](#)

- Example:** [BB:EUTR:UL:UE2:REFS:SRS:CYCS 5](#)
 Sets the SRS cyclic shift for UE2
- Options:** <CyclicShift> = 7 to 11 require R&S SMM-K119
- Manual operation:** See ["SRS Cyclic Shift n_CS \(First AP\)"](#) on page 271

[:SOURce<hw>]:BB:EUTRa:UL:UE<st>[:CELL<ccid>]:REFSig:SRS[<srsid>]:NTRans <Transmissions>

Sets the number of SRS transmissions.

Parameters:
 <Transmissions> integer
 Range: 0 to (10*SeqLengthARB - 1)
 *RST: 0

- Example:** See [\[:SOURce<hw>\]:BB:EUTRa:UL:UE<st>\[:CELL<ccid>\]:REFSig:SRS:TT0](#) on page 763
- Options:** R&S SMM-K85
- Manual operation:** See ["Number of Transmissions"](#) on page 277

[:SOURce<hw>]:BB:EUTRa:UL:UE<st>[:CELL<ccid>]:REFSig:SRS[<srsid>]:UPPTsadd <SrsUpPtsAdd>

In TDD mode, sets the parameter `srs-UpPtsAdd` and defines the number of additional SC-FDMA symbols in UpPTS.

Parameters:

<SrsUpPtsAdd> 0 | 2 | 4
 *RST: 0

Example:

SOURce1:BB:EUTRa:DUPLexing TDD
 SOURce1:BB:EUTRa:UL:UE1:CELL0:REFSig:SRS1:UPPTsadd 2

Options:

R&S SMM-K119

Manual operation: See "SRS UpPTS Add" on page 271

**[:SOURce<hw>]:BB:EUTRa:UL:UE<st>[:CELL<ccid>]:REFSig:SRS[<srsid>]:
 SUBF<subfid> <Subframe>**

Sets the subframes in that SRS is transmitted.

Suffix:

<subfid> 1 to 50
 Transmission number, as set with [:SOURce<hw>]:BB:
 EUTRa:UL:UE<st>[:CELL<ccid>]:REFSig:
 SRS[<srsid>]:NTRans

Parameters:

<Subframe> integer
 Range: 0 to (10*SeqLengthARB - 1)
 *RST: 0

Example:

See [:SOURce<hw>]:BB:EUTRa:UL:UE<st>[:
 CELL<ccid>]:REFSig:SRS:TT0 on page 763

Options:

R&S SMM-K85

Manual operation: See "Subframes for Transmission" on page 277

**[:SOURce<hw>]:BB:EUTRa:UL:UE<st>[:CELL<ccid>]:REFSig:SRS:BHOP
 <BandwidthHopp>**

Sets the UE-specific parameter frequency hopping bandwidth b_{hop} .

Parameters:

<BandwidthHopp> integer
 Range: 0 to 3
 *RST: 0

Example:

BB:EUTRa:UL:UE2:REFS:SRS:BHOP 2
 Sets the SRS hopping bandwidth

Manual operation: See "Hopping Bandwidth b_{hop} " on page 276

**[:SOURce<hw>]:BB:EUTRa:UL:UE<st>[:CELL<ccid>]:REFSig:SRS[<srsid>]:
 BSRS <Bsrs>**

Sets the UE-specific parameter SRS bandwidth B_{SRS} .

Parameters:

<Bsrs> integer
 Range: 0 to 3
 *RST: 0

Example:

BB:EUTR:UL:UE2:REFS:SRS:BSRS 2
 Sets the SRS bandwidth configuration

Manual operation: See "[SRS Bandwidth B_SRS](#)" on page 274

**[:SOURCE<hw>] : BB : EUTRa : UL : UE<st> [: CELL<ccidx>] : REFSig : SRS [<srsidx>] :
 ISRS <lsrs>**

Sets the UE-specific parameter SRS configuration index I_{SRS} .

Parameters:

<lsrs> integer
 Range: 0 to 1023
 *RST: 0

Example:

BB:EUTR:DUPL FDD
 Sets the duplexing mode
 BB:EUTR:UL:UE2:REFS:SRS:ISRS 22
 Sets the SRS configuration index

Manual operation: See "[Configuration Index I_SRS](#)" on page 272

**[:SOURCE<hw>] : BB : EUTRa : UL : UE<st> [: CELL<ccidx>] : REFSig : SRS [<srsidx>] :
 TSRS?**

Queries the UE-specific parameter SRS periodicity T_{SRS} .

The value depends on the selected SRS configuration index I_{SRS} ([\[:SOURCE<hw> \] : BB : EUTRa : UL : UE<st> \[: CELL<ccidx> \] : REFSig : SRS \[<srsidx> \] : ISRS](#)) and duplexing mode ([\[:SOURCE<hw> \] : BB : EUTRa : DUPLexing](#)) as defined in the TS 36.213.

Return values:

<PeriodTsrs> integer
 Range: 0 to 65535
 *RST: 0

Example:

BB:EUTR:DUPL FDD
 BB:EUTR:UL:UE2:REFS:SRS:ISRS 22
 BB:EUTR:UL:UE2:REFS:SRS:TSRS?
 // 20

Usage: Query only

Manual operation: See "[Periodicity T_SRS](#)" on page 272

**[[:SOURce<hw>]:BB:EUTRa:UL:UE<st>]:CELL<ccid>]:REFSig:SRS[<srsidx>]:
TOFFset?**

Queries the UE-specific parameter SRS subframe offset T_{offset} .

Return values:

<TOffset> integer
 Range: 0 to 320
 *RST: 0

Example: BB:EUTR:DUPL FDD
 Sets the duplexing mode
 BB:EUTR:UL:UE2:REFS:SRS:ISRS 22
 Sets the SRS configuration index
 BB:EUTR:UL:UE2:REFS:SRS:TOFF?
 Queries the SRS subframe offset
 Response: 5

Usage: Query only

Manual operation: See "[Subframe Offset \$T_{\text{offset}}\$](#) " on page 273

**[[:SOURce<hw>]:BB:EUTRa:UL:UE<st>]:CELL<ccid>]:REFSig:SRS[<srsidx>]:
TRComb <TransmComb>**

Sets the UE-specific parameter transmission comb k_{TC} .

Parameters:

<TransmComb> integer
 Range: 0 to 1
 *RST: 0

Example: BB:EUTR:UL:UE2:REFS:SRS:TRC 1

Manual operation: See "[Transmission Comb \$k_{\text{TC}}\$](#) " on page 276

**[[:SOURce<hw>]:BB:EUTRa:UL:UE<st>]:CELL<ccid>]:REFSig:SRS[<srsidx>]:
NKTC <TranCombNumKTC>**

In TDD mode, sets the UE-specific parameter number of combs ($\text{transmissionCombNum}$).

Parameters:

<TranCombNumKTC>2 | 4
 *RST: 2

Example: SOURcel:BB:EUTRa:DUPLexing TDD
 SOURcel:BB:EUTRa:UL:UE1:CELL0:REFSig:SRS1:NKTC 2

Options: R&S SMM-K119

Manual operation: See "[Transmission Comb Num \$k_{\text{TC}}\$](#) " on page 276

```
[:SOURCE<hw>]:BB:EUTRa:UL:UE<st>[:CELL<ccid>]:REFSig:SRS[<srsidx>]:
  NRRC <Nrrc>
```

Sets the UE-specific parameter `freqDomainPositionnRRc`

Parameters:

```
<Nrrc>                integer
                        Range:    0 to 23
                        *RST:     0
```

Example: `BB:EUTRa:UL:UE2:REFS:SRS:NRRC 10`
Sets the SRS frequency domain position

Manual operation: See "[Freq. Domain Position n_{RRc}](#)" on page 277

```
[:SOURCE<hw>]:BB:EUTRa:UL:UE<st>:APMap:AP10Map:ROW<bbid>
  <AntPortMapping>
[:SOURCE<hw>]:BB:EUTRa:UL:UE<st>:APMap:AP20Map:ROW<bbid>
  <AntPortMapping>
[:SOURCE<hw>]:BB:EUTRa:UL:UE<st>:APMap:AP21Map:ROW<bbid>
  <AntPortMapping>
[:SOURCE<hw>]:BB:EUTRa:UL:UE<st>:APMap:AP40Map:ROW<bbid>
  <AntPortMapping>
[:SOURCE<hw>]:BB:EUTRa:UL:UE<st>:APMap:AP41Map:ROW<bbid>
  <AntPortMapping>
[:SOURCE<hw>]:BB:EUTRa:UL:UE<st>:APMap:AP42Map:ROW<bbid>
  <AntPortMapping>
[:SOURCE<hw>]:BB:EUTRa:UL:UE<st>:APMap:AP43Map:ROW<bbid>
  <AntPortMapping>
[:SOURCE<hw>]:BB:EUTRa:UL:UE<st>:APMap:AP100Map:ROW<bbid>
  <AntPortMapping>
[:SOURCE<hw>]:BB:EUTRa:UL:UE<st>:APMap:AP1010Map:ROW<bbid>
  <AntPortMapping>
[:SOURCE<hw>]:BB:EUTRa:UL:UE<st>:APMap:AP1020Map:ROW<bbid>
  <AntPortMapping>
[:SOURCE<hw>]:BB:EUTRa:UL:UE<st>:APMap:AP100Map:ROW<bbid>
  <AntPortMapping>
[:SOURCE<hw>]:BB:EUTRa:UL:UE<st>:APMap:AP200Map:ROW<bbid>
  <AntPortMapping>
[:SOURCE<hw>]:BB:EUTRa:UL:UE<st>:APMap:AP201Map:ROW<bbid>
  <AntPortMapping>
```

Sets which antenna port will be generated by which baseband.

Suffix:

```
<bbid>                0..7
                        Baseband
```

Parameters:

```
<AntPortMapping>    1 | ON | 0 | OFF
                        *RST:    0
```

Example: `SOURce1:BB:EUTRa:UL:UE1:APMap:AP10Map:ROW0 1`

Manual operation: See "[Antenna port mapping table](#)" on page 305

[:SOURce<hw>]:BB:EUTRa:UL:UE<st>:CELL<dir0>:POFFset <UeCcPowerOffs>

Sets a power offset of the selected PCell or SCell.

Parameters:

<UeCcPowerOffs> float
 Range: -80 to 10
 Increment: 0.01
 *RST: 0
 Default unit: dB

Example: `SOURce1:BB:EUTRa:UL:UE1:CELL1:POFFset 3`

Manual operation: See "[Power](#)" on page 305

10.26 Sidelink configuration

Option: R&S SMM-K113

Example: Enabling sidelink transmission in communication mode

```
SOURce1:BB:EUTRa:LINK UP
SOURce1:BB:EUTRa:UL:UE1:RELease LADV
SOURce1:BB:EUTRa:UL:UE1:SL:STAtE 1
SOURce1:BB:EUTRa:UL:UE1:SL:MODE COMM
SOURce1:BB:EUTRa:UL:UE1:SL:DATA PN9
SOURce1:BB:EUTRa:UL:UE1:SL:REStArt 1

// configure the control resource pool
SOURce1:BB:EUTRa:UL:UE1:SL:RCTRL:CPERiod 40
SOURce1:BB:EUTRa:UL:UE1:SL:RCTRL:OFFSetind 1
SOURce1:BB:EUTRa:UL:UE1:SL:RCTRL:PRBStArt 1
SOURce1:BB:EUTRa:UL:UE1:SL:RCTRL:PRENd 45
SOURce1:BB:EUTRa:UL:UE1:SL:RCTRL:PRBNumber 2
SOURce1:BB:EUTRa:UL:UE1:SL:RCTRL:SFBMp #HCF0AF0ACC3,40

// configure the data resource pool
SOURce1:BB:EUTRa:UL:UE1:SL:RDATa:OFFSetind 1
SOURce1:BB:EUTRa:UL:UE1:SL:RDATa:PRBStArt 0
SOURce1:BB:EUTRa:UL:UE1:SL:RDATa:PRENd 49
SOURce1:BB:EUTRa:UL:UE1:SL:RDATa:PRBNumber 2
SOURce1:BB:EUTRa:UL:UE1:SL:RDATa:SFBMp #HFFFFFFF,40
SOURce1:BB:EUTRa:UL:UE1:SL:RDATa:TRPTsubset #H5,3
SOURce1:BB:EUTRa:UL:UE1:SL:RDATa:HOPPpingparam 1
SOURce1:BB:EUTRa:UL:UE1:SL:RDATa:NSUBbands 2
SOURce1:BB:EUTRa:UL:UE1:SL:RDATa:RBOFFset 1
```

```

// configure the synchronization signal
SOURCEl:BB:EUTRa:UL:UE1:SL:SYNC:STAtE 1
SOURCEl:BB:EUTRa:UL:UE1:SL:SYNC:INCoverage 1
SOURCEl:BB:EUTRa:UL:UE1:SL:SYNC:SLSSid 165
SOURCEl:BB:EUTRa:UL:UE1:SL:SYNC:OFFSetind 1

// configure the SL control information
SOURCEl:BB:EUTRa:UL:UE1:SL:NSCI 1
SOURCEl:BB:EUTRa:UL:UE1:SL:SCI0:TXMode 1
SOURCEl:BB:EUTRa:UL:UE1:SL:SCI0:PSCPeriod 10
SOURCEl:BB:EUTRa:UL:UE1:SL:SCI0:NPSCch 10
SOURCEl:BB:EUTRa:UL:UE1:SL:SCI0:SF?
// 1,2
SOURCEl:BB:EUTRa:UL:UE1:SL:SCI0:FORMat?
// 0
SOURCEl:BB:EUTRa:UL:UE1:SL:SCI0:FHFFlag 1
SOURCEl:BB:EUTRa:UL:UE1:SL:SCI0:RBAHoppalloc 10
SOURCEl:BB:EUTRa:UL:UE1:SL:SCI0:TRP 101
SOURCEl:BB:EUTRa:UL:UE1:SL:SCI0:MCS 28
SOURCEl:BB:EUTRa:UL:UE1:SL:SCI0:TAINd 1
SOURCEl:BB:EUTRa:UL:UE1:SL:SCI0:GRID 1
// configure the allocations
// PSBCH
SOURCEl:BB:EUTRa:UL:UE1:SL:ALLoc0:CONTent?
// PSBCH
SOURCEl:BB:EUTRa:UL:UE1:SL:ALLoc0:MOD?
// QPSK
SOURCEl:BB:EUTRa:UL:UE1:SL:ALLoc0:POWER 0
SOURCEl:BB:EUTRa:UL:UE1:SL:ALLoc0:STAtE 1
SOURCEl:BB:EUTRa:UL:UE1:SL:ALLoc0:CONFLict?
// 0
SOURCEl:BB:EUTRa:UL:UE1:SL:ALLoc0:CYCShift 1
SOURCEl:BB:EUTRa:UL:UE1:SL:ALLoc0:SCRambling:STAtE 1
SOURCEl:BB:EUTRa:UL:UE1:SL:ALLoc0:CCODing:STAtE 1

// PSCCH
SOURCEl:BB:EUTRa:UL:UE1:SL:ALLoc1:CONTent?
// PSCCH
SOURCEl:BB:EUTRa:UL:UE1:SL:ALLoc1:SF?
// 1,2
SOURCEl:BB:EUTRa:UL:UE1:SL:ALLoc1:MOD?
// QPSK
SOURCEl:BB:EUTRa:UL:UE1:SL:ALLoc1:PHYsbits?
// 288
SOURCEl:BB:EUTRa:UL:UE1:SL:ALLoc1:POWER 0
SOURCEl:BB:EUTRa:UL:UE1:SL:ALLoc1:STAtE 1
SOURCEl:BB:EUTRa:UL:UE1:SL:ALLoc1:CONFLict?
// 0

// PSSCH

```

```

SOURCE1:BB:EUTRA:UL:UE1:SL:ALLOC2:CONTENT?
// PSSCH
SOURCE1:BB:EUTRA:UL:UE1:SL:ALLOC2:MOD?
// QPSK
SOURCE1:BB:EUTRA:UL:UE1:SL:ALLOC2:PHYSBITS?
// 288
SOURCE1:BB:EUTRA:UL:UE1:SL:ALLOC2:POWER 0
SOURCE1:BB:EUTRA:UL:UE1:SL:ALLOC2:STATE 1
SOURCE1:BB:EUTRA:UL:UE1:SL:ALLOC2:CONFLICT?
// 0
SOURCE1:BB:EUTRA:UL:UE1:SL:ALLOC0:CYCSHIFT 0
SOURCE1:BB:EUTRA:UL:UE1:SL:ALLOC0:SCRAMBLING:STATE 1
SOURCE1:BB:EUTRA:UL:UE1:SL:ALLOC0:CCODING:STATE 1
SOURCE1:BB:EUTRA:UL:UE1:SL:ALLOC0:TBSI?
// 0
SOURCE1:BB:EUTRA:UL:UE1:SL:ALLOC0:TBSIZE?
// 32

```

Example: Enabling sidelink transmission in discovery mode

```

SOURCE1:BB:EUTRA:LINK UP
SOURCE1:BB:EUTRA:UL:UE1:RELEASE LADV
SOURCE1:BB:EUTRA:UL:UE1:SL:STATE 1
SOURCE1:BB:EUTRA:UL:UE1:SL:MODE DISC

// configure the resource pool
SOURCE1:BB:EUTRA:UL:UE1:SL:RDISC:CPERIOD 64
SOURCE1:BB:EUTRA:UL:UE1:SL:RDISC:OFFSETIND 10
SOURCE1:BB:EUTRA:UL:UE1:SL:RDISC:PRBSTART 10
SOURCE1:BB:EUTRA:UL:UE1:SL:RDISC:PREND 45
SOURCE1:BB:EUTRA:UL:UE1:SL:RDISC:PRBNUMBER 10
SOURCE1:BB:EUTRA:UL:UE1:SL:RDISC:PRINDEX 10
SOURCE1:BB:EUTRA:UL:UE1:SL:RDISC:SFBMP #HEAAAA954AB,40
SOURCE1:BB:EUTRA:UL:UE1:SL:RDISC:NRETRANS 2
SOURCE1:BB:EUTRA:UL:UE1:SL:RDISC:NREPETITIONS 2
SOURCE1:BB:EUTRA:UL:UE1:SL:RDISC:N1PDSCH 1
SOURCE1:BB:EUTRA:UL:UE1:SL:RDISC:SFINDEX 2

// configure the allocations
SOURCE1:BB:EUTRA:UL:UE1:SL:NALLOC 2
SOURCE1:BB:EUTRA:UL:UE1:SL:ALLOC0:CONT?
// PSBCH
SOURCE1:BB:EUTRA:UL:UE1:SL:ALLOC0:DISCTYPE D1
SOURCE1:BB:EUTRA:UL:UE1:SL:ALLOC0:PSDPERIOD 2
SOURCE1:BB:EUTRA:UL:UE1:SL:ALLOC0:NPDSCH 5
SOURCE1:BB:EUTRA:UL:UE1:SL:ALLOC0:SF?
SOURCE1:BB:EUTRA:UL:UE1:SL:ALLOC0:MOD?
// QPSK
SOURCE1:BB:EUTRA:UL:UE1:SL:ALLOC0:PHYSBITS?
SOURCE1:BB:EUTRA:UL:UE1:SL:ALLOC0:POWER 0
SOURCE1:BB:EUTRA:UL:UE1:SL:ALLOC0:STATE 1

```



```

SOURCEl:BB:EUTRa:UL:UE1:SL:ALLoc0:CONFLICT?
// 0
SOURCEl:BB:EUTRa:UL:UE1:SL:ALLoc0:CYCShift 0
SOURCEl:BB:EUTRa:UL:UE1:SL:ALLoc0:SCRambling:STATE 1
SOURCEl:BB:EUTRa:UL:UE1:SL:ALLoc0:CCODing:STATE 1
SOURCEl:BB:EUTRa:UL:UE1:SL:ALLoc0:PHYSbits?
SOURCEl:BB:EUTRa:UL:UE1:SL:ALLoc0:TBSIZE?

SOURCEl:BB:EUTRa:UL:UE1:SL:ALLoc1:CONT?
// PSDCH
SOURCEl:BB:EUTRa:UL:UE1:SL:ALLoc1:DISCtype D1
SOURCEl:BB:EUTRa:UL:UE1:SL:ALLoc1:PSDPeriod 0
SOURCEl:BB:EUTRa:UL:UE1:SL:ALLoc1:NPDSch 0
SOURCEl:BB:EUTRa:UL:UE1:SL:ALLoc1:SF?
// 10, 11,12
SOURCEl:BB:EUTRa:UL:UE1:SL:ALLoc1:MOD?
// QPSK
SOURCEl:BB:EUTRa:UL:UE1:SL:ALLoc1:PHYSbits?
//576
SOURCEl:BB:EUTRa:UL:UE1:SL:ALLoc1:POWER 0
SOURCEl:BB:EUTRa:UL:UE1:SL:ALLoc1:STATE 1
SOURCEl:BB:EUTRa:UL:UE1:SL:ALLoc1:CONFLICT?
// 0

```

Example: Enabling sidelink transmission in V2X mode

Option: R&S SMM-K119

```

SOURCEl:BB:EUTRa:STDMODE LTE
SOURCEl:BB:EUTRa:DUPLExing FDD
SOURCEl:BB:EUTRa:LINK UP
SOURCEl:BB:EUTRa:UL:UE1:RELEase LADV
SOURCEl:BB:EUTRa:UL:UE1:SL:STATE 1
SOURCEl:BB:EUTRa:UL:UE1:SL:MODE V2X

// configure the resource pool
SOURCEl:BB:EUTRa:UL:UE1:SL:V2X:OFFSet 1
SOURCEl:BB:EUTRa:UL:UE1:SL:V2X:BMPLength 20
SOURCEl:BB:EUTRa:UL:UE1:SL:V2X:BITLow #HFFF0F,20
SOURCEl:BB:EUTRa:UL:UE1:SL:V2X:ADJC 1
SOURCEl:BB:EUTRa:UL:UE1:SL:V2X:SUBChannels 3
SOURCEl:BB:EUTRa:UL:UE1:SL:V2X:SUBSize 5
SOURCEl:BB:EUTRa:UL:UE1:SL:V2X:SRBSubchan 1

// configure the synchronization signal
SOURCEl:BB:EUTRa:UL:UE1:SL:SYNC:STATE 1
SOURCEl:BB:EUTRa:UL:UE1:SL:SYNC:INCoverage 1
SOURCEl:BB:EUTRa:UL:UE1:SL:SYNC:SLSSid 165
SOURCEl:BB:EUTRa:UL:UE1:SL:SYNC:OFFSetind 1

// configure the SL control information
SOURCEl:BB:EUTRa:UL:UE1:SL:SCI0:TXMode 4

```

```

SOURCEl:BB:EUTRa:UL:UE1:SL:SCI0:STARtsf 1
SOURCEl:BB:EUTRa:UL:UE1:SL:SCI0:SUBChannel 1
SOURCEl:BB:EUTRa:UL:UE1:SL:SCI0:SCI0:SF?
// 1,6
SOURCEl:BB:EUTRa:UL:UE1:SL:SCI0:FORMat?
// 1
SOURCEl:BB:EUTRa:UL:UE1:SL:SCI0:PRIRity 1
SOURCEl:BB:EUTRa:UL:UE1:SL:SCI0:RREServation 2
SOURCEl:BB:EUTRa:UL:UE1:SL:SCI0:FREQresloc 1
SOURCEl:BB:EUTRa:UL:UE1:SL:SCI0:TIMGap 5
SOURCEl:BB:EUTRa:UL:UE1:SL:SCI0:MCS 10
SOURCEl:BB:EUTRa:UL:UE1:SL:SCI0:BITData?

// configure the allocations
SOURCEl:BB:EUTRa:UL:UE1:SL:ALLOc0:CONTent?
// PSBCH
SOURCEl:BB:EUTRa:UL:UE1:SL:ALLOc0:SF?
// 1
SOURCEl:BB:EUTRa:UL:UE1:SL:ALLOc0:MOD?
// QPSK
SOURCEl:BB:EUTRa:UL:UE1:SL:ALLOc0:CYCShift 1
SOURCEl:BB:EUTRa:UL:UE1:SL:ALLOc0:SCRambling:STATe 1
SOURCEl:BB:EUTRa:UL:UE1:SL:ALLOc0:CCODing:STATe 1
SOURCEl:BB:EUTRa:UL:UE1:SL:ALLOc0:PHYSbits?
// 1008
SOURCEl:BB:EUTRa:UL:UE1:SL:ALLOc0:POWer 0
SOURCEl:BB:EUTRa:UL:UE1:SL:ALLOc0:STATe 1
SOURCEl:BB:EUTRa:UL:UE1:SL:ALLOc0:CONFLict?
// 0

SOURCEl:BB:EUTRa:UL:UE1:SL:ALLOc1:CONTent?
// PSCCH
SOURCEl:BB:EUTRa:UL:UE1:SL:ALLOc1:SF?
// 1,6
SOURCEl:BB:EUTRa:UL:UE1:SL:ALLOc1:MOD?
// QPSK
SOURCEl:BB:EUTRa:UL:UE1:SL:ALLOc1:CYCShift 1
SOURCEl:BB:EUTRa:UL:UE1:SL:ALLOc1:SCRambling:STATe 1
SOURCEl:BB:EUTRa:UL:UE1:SL:ALLOc1PHYSbits?
// 480
SOURCEl:BB:EUTRa:UL:UE1:SL:ALLOc1:POWer 0
SOURCEl:BB:EUTRa:UL:UE1:SL:ALLOc1:STATe 1
SOURCEl:BB:EUTRa:UL:UE1:SL:ALLOc1:CONFLict?
// 0

SOURCEl:BB:EUTRa:UL:UE1:SL:ALLOc2:CONTent?
// PSSCH
SOURCEl:BB:EUTRa:UL:UE1:SL:ALLOc2:SF?
// 1,6
SOURCEl:BB:EUTRa:UL:UE1:SL:ALLOc2:MOD?

```

```
// QPSK
SOURCE1:BB:EUTRa:UL:UE1:SL:ALLoc2:CYCShift 1
SOURCE1:BB:EUTRa:UL:UE1:SL:ALLoc2:SCRambling:STATe 1
SOURCE1:BB:EUTRa:UL:UE1:SL:ALLoc2:PHYSbits?
// 720
SOURCE1:BB:EUTRa:UL:UE1:SL:ALLoc2:TBSI?
// 10
SOURCE1:BB:EUTRa:UL:UE1:SL:ALLoc2:TBSize?
// 680
SOURCE1:BB:EUTRa:UL:UE1:SL:ALLoc2:POWer 0
SOURCE1:BB:EUTRa:UL:UE1:SL:ALLoc2:STATe 1
SOURCE1:BB:EUTRa:UL:UE1:SL:ALLoc2:CONFLICT?
// 0
```

Example: Configuring RMC

Option: R&S SMM-K119

```
SOURCE1:BB:EUTRa:STDMoDe LTE
SOURCE1:BB:EUTRa:DUPLexing FDD
SOURCE1:BB:EUTRa:LINK UP
SOURCE1:BB:EUTRa:UL:UE1:RELease LADV
SOURCE1:BB:EUTRa:UL:UE1:SL:STATe 1
SOURCE1:BB:EUTRa:UL:UE1:SL:MoDE V2X
```

```
SOURCE1:BB:EUTRa:UL:UE1:SL:RMC:
SOURCE1:BB:EUTRa:UL:UE1:SL:RMC:RMC R821
SOURCE1:BB:EUTRa:UL:UE1:SL:RMC:ARBLocks?
// 48
SOURCE1:BB:EUTRa:UL:UE1:SL:RMC:MoDulation?
// QPSK
SOURCE1:BB:EUTRa:UL:UE1:SL:RMC:PAYSize?
// 3496
SOURCE1:BB:EUTRa:UL:UE1:SL:RMC:PHYSbits?
// 11520
SOURCE1:BB:EUTRa:UL:UE1:SL:RMC:STATe 1
```

```
[SOURCE<hw>]:BB:EUTRa:UL:UE<st>:SL:STATe..... 777
[SOURCE<hw>]:BB:EUTRa:UL:UE<st>:SL:MoDE..... 777
[SOURCE<hw>]:BB:EUTRa:UL:UE<st>:SL:DATA..... 778
[SOURCE<hw>]:BB:EUTRa:UL:UE<st>:SL:DSElect..... 778
[SOURCE<hw>]:BB:EUTRa:UL:UE<st>:SL:PATtern..... 778
[SOURCE<hw>]:BB:EUTRa:UL:UE<st>:SL:REStart..... 778
[SOURCE<hw>]:BB:EUTRa:UL:UE<st>:SL:RDISc:CPERiod..... 779
[SOURCE<hw>]:BB:EUTRa:UL:UE<st>:SL:RCTRI:CPERiod..... 779
[SOURCE<hw>]:BB:EUTRa:UL:UE<st>:SL:RDATa:OFFSetind..... 779
[SOURCE<hw>]:BB:EUTRa:UL:UE<st>:SL:RDISc:OFFSetind..... 779
[SOURCE<hw>]:BB:EUTRa:UL:UE<st>:SL:V2X:OFFSet..... 779
[SOURCE<hw>]:BB:EUTRa:UL:UE<st>:SL:RCTRI:OFFSetind..... 779
[SOURCE<hw>]:BB:EUTRa:UL:UE<st>:SL:RDATa:PRBStart..... 780
[SOURCE<hw>]:BB:EUTRa:UL:UE<st>:SL:RDATa:PRENd..... 780
[SOURCE<hw>]:BB:EUTRa:UL:UE<st>:SL:RDISc:PRBStart..... 780
```

[SOURce<hw>]:BB:EUTRa:UL:UE<st>:SL:RDISc:PRENd.....	780
[SOURce<hw>]:BB:EUTRa:UL:UE<st>:SL:RCTRI:PRBStart.....	780
[SOURce<hw>]:BB:EUTRa:UL:UE<st>:SL:RCTRI:PRENd.....	780
[SOURce<hw>]:BB:EUTRa:UL:UE<st>:SL:RDATa:PRBNumber.....	780
[SOURce<hw>]:BB:EUTRa:UL:UE<st>:SL:RDISc:PRBNumber.....	780
[SOURce<hw>]:BB:EUTRa:UL:UE<st>:SL:RCTRI:PRBNumber.....	780
[SOURce<hw>]:BB:EUTRa:UL:UE<st>:SL:RDATa:SFBMp.....	780
[SOURce<hw>]:BB:EUTRa:UL:UE<st>:SL:RDISc:SFBMp.....	780
[SOURce<hw>]:BB:EUTRa:UL:UE<st>:SL:RCTRI:SFBMp.....	780
[SOURce<hw>]:BB:EUTRa:UL:UE<st>:SL:RDISc:NRETrans.....	781
[SOURce<hw>]:BB:EUTRa:UL:UE<st>:SL:RDISc:NREPetitions.....	781
[SOURce<hw>]:BB:EUTRa:UL:UE<st>:SL:RDISc:N1PDsch.....	781
[SOURce<hw>]:BB:EUTRa:UL:UE<st>:SL:RDISc:N2PDsch.....	782
[SOURce<hw>]:BB:EUTRa:UL:UE<st>:SL:RDISc:N3PDsch.....	782
[SOURce<hw>]:BB:EUTRa:UL:UE<st>:SL:V2X:BMPLength.....	782
[SOURce<hw>]:BB:EUTRa:UL:UE<st>:SL:V2X:BITLow.....	782
[SOURce<hw>]:BB:EUTRa:UL:UE<st>:SL:V2X:BITHigh.....	783
[SOURce<hw>]:BB:EUTRa:UL:UE<st>:SL:V2X:ADJc.....	783
[SOURce<hw>]:BB:EUTRa:UL:UE<st>:SL:V2X:SUBChannels.....	784
[SOURce<hw>]:BB:EUTRa:UL:UE<st>:SL:V2X:SRBSubchan.....	784
[SOURce<hw>]:BB:EUTRa:UL:UE<st>:SL:V2X:SUBSize.....	784
[SOURce<hw>]:BB:EUTRa:UL:UE<st>:SL:RDISc:SFIndex.....	784
[SOURce<hw>]:BB:EUTRa:UL:UE<st>:SL:RDISc:PRIndex.....	785
[SOURce<hw>]:BB:EUTRa:UL:UE<st>:SL:RDATa:TRPTsubset.....	785
[SOURce<hw>]:BB:EUTRa:UL:UE<st>:SL:RDATa:HOPPIngparam.....	785
[SOURce<hw>]:BB:EUTRa:UL:UE<st>:SL:RDATa:NSUBbands.....	785
[SOURce<hw>]:BB:EUTRa:UL:UE<st>:SL:RDATa:RBOFfset.....	786
[SOURce<hw>]:BB:EUTRa:UL:UE<st>:SL:SYNC:STATe.....	786
[SOURce<hw>]:BB:EUTRa:UL:UE<st>:SL:SYNC:INCoverage.....	786
[SOURce<hw>]:BB:EUTRa:UL:UE<st>:SL:SYNC:SLSSid.....	787
[SOURce<hw>]:BB:EUTRa:UL:UE<st>:SL:SYNC:OFFSetind.....	787
[SOURce<hw>]:BB:EUTRa:UL:UE<st>:SL:NSCI.....	787
[SOURce<hw>]:BB:EUTRa:UL:UE<st>:SL:SCI<ch0>:TXMode.....	787
[SOURce<hw>]:BB:EUTRa:UL:UE<st>:SL:SCI<ch0>:PSCPeriod.....	788
[SOURce<hw>]:BB:EUTRa:UL:UE<st>:SL:SCI<ch0>:NPSCch.....	788
[SOURce<hw>]:BB:EUTRa:UL:UE<st>:SL:SCI<ch0>:SF?.....	788
[SOURce<hw>]:BB:EUTRa:UL:UE<st>:SL:SCI<ch0>:FORMat.....	788
[SOURce<hw>]:BB:EUTRa:UL:UE<st>:SL:SCI<ch0>:STARtsf.....	789
[SOURce<hw>]:BB:EUTRa:UL:UE<st>:SL:SCI<ch0>:SUBChannel.....	789
[SOURce<hw>]:BB:EUTRa:UL:UE<st>:SL:SCI<ch0>:BITData?.....	789
[SOURce<hw>]:BB:EUTRa:UL:UE<st>:SL:SCI<ch0>:FHFLag.....	790
[SOURce<hw>]:BB:EUTRa:UL:UE<st>:SL:SCI<ch0>:RBAHoppalloc.....	790
[SOURce<hw>]:BB:EUTRa:UL:UE<st>:SL:SCI<ch0>:TRP.....	790
[SOURce<hw>]:BB:EUTRa:UL:UE<st>:SL:SCI<ch0>:MCS.....	790
[SOURce<hw>]:BB:EUTRa:UL:UE<st>:SL:SCI<ch0>:TAINd.....	791
[SOURce<hw>]:BB:EUTRa:UL:UE<st>:SL:SCI<ch0>:GRID.....	791
[SOURce<hw>]:BB:EUTRa:UL:UE<st>:SL:SCI<ch0>:FREQresloc.....	791
[SOURce<hw>]:BB:EUTRa:UL:UE<st>:SL:SCI<ch0>:PRIRity.....	791
[SOURce<hw>]:BB:EUTRa:UL:UE<st>:SL:SCI<ch0>:RREServation.....	792
[SOURce<hw>]:BB:EUTRa:UL:UE<st>:SL:SCI<ch0>:TIMGap.....	792

<code>[SOURce<hw>]:BB:EUTRa:UL:UE<st>:SL:SCI<ch0>:TXINdex</code>	792
<code>[SOURce<hw>]:BB:EUTRa:UL:UE<st>:SL:NALLoc</code>	792
<code>[SOURce<hw>]:BB:EUTRa:UL:UE<st>:SL:ALLoc<ch0>:CONTent?</code>	793
<code>[SOURce<hw>]:BB:EUTRa:UL:UE<st>:SL:ALLoc<ch0>:DISCtype</code>	793
<code>[SOURce<hw>]:BB:EUTRa:UL:UE<st>:SL:ALLoc<ch0>:PSDPeriod</code>	793
<code>[SOURce<hw>]:BB:EUTRa:UL:UE<st>:SL:ALLoc<ch0>:NPDSch</code>	794
<code>[SOURce<hw>]:BB:EUTRa:UL:UE<st>:SL:ALLoc<ch0>:SF?</code>	794
<code>[SOURce<hw>]:BB:EUTRa:UL:UE<st>:SL:ALLoc<ch0>:MODulation?</code>	794
<code>[SOURce<hw>]:BB:EUTRa:UL:UE<st>:SL:ALLoc<ch0>:PHYSbits?</code>	794
<code>[SOURce<hw>]:BB:EUTRa:UL:UE<st>:SL:ALLoc<ch0>:POWer</code>	795
<code>[SOURce<hw>]:BB:EUTRa:UL:UE<st>:SL:ALLoc<ch0>:STATe</code>	795
<code>[SOURce<hw>]:BB:EUTRa:UL:UE<st>:SL:ALLoc<ch0>:CONFLict?</code>	795
<code>[SOURce<hw>]:BB:EUTRa:UL:UE<st>:SL:ALLoc<ch0>:CYCShift</code>	796
<code>[SOURce<hw>]:BB:EUTRa:UL:UE<st>:SL:ALLoc<ch0>:SCRambling:STATe</code>	796
<code>[SOURce<hw>]:BB:EUTRa:UL:UE<st>:SL:ALLoc<ch0>:CCODing:STATe</code>	796
<code>[SOURce<hw>]:BB:EUTRa:UL:UE<st>:SL:ALLoc<ch0>:CCODing:TBSI?</code>	796
<code>[SOURce<hw>]:BB:EUTRa:UL:UE<st>:SL:ALLoc<ch0>:CCODing:TBSize?</code>	797
<code>[SOURce<hw>]:BB:EUTRa:UL:UE<st>:SL:RMC:STATe</code>	797
<code>[SOURce<hw>]:BB:EUTRa:UL:UE<st>:SL:RMC:RMC</code>	797
<code>[SOURce<hw>]:BB:EUTRa:UL:UE<st>:SL:RMC:ARBLocks?</code>	798
<code>[SOURce<hw>]:BB:EUTRa:UL:UE<st>:SL:RMC:MODulation?</code>	798
<code>[SOURce<hw>]:BB:EUTRa:UL:UE<st>:SL:RMC:PAYSize?</code>	798
<code>[SOURce<hw>]:BB:EUTRa:UL:UE<st>:SL:RMC:PHYSbits?</code>	798

`[SOURce<hw>]:BB:EUTRa:UL:UE<st>:SL:STATe <State>`

Enables sidelink transmission.

Parameters:

<State> 1 | ON | 0 | OFF
*RST: 1

Example: See [Example"Enabling sidelink transmission in communication mode"](#) on page 770.

Manual operation: See ["State"](#) on page 279

`[SOURce<hw>]:BB:EUTRa:UL:UE<st>:SL:MODE <Mode>`

Sets the mode of the sidelink communication.

Parameters:

<Mode> COMM | DISC | V2X
*RST: COMM

Example: See [Example"Enabling sidelink transmission in communication mode"](#) on page 770.

Options: V2X requires R&S SMM-K119

Manual operation: See ["Mode"](#) on page 279

```
[:SOURce<hw>]:BB:EUTRa:UL:UE<st>:SL:DATA <DataSource>
```

Sets the data source for the sidelink.

Parameters:

```
<DataSource>    PN9 | PN11 | PN15 | PN16 | PN20 | PN21 | PN23 | PATTErn |
                 DLISt | ZERO | ONE
*RST:           PN9
```

Example: See [Example "Enabling sidelink transmission in communication mode"](#) on page 770.

Manual operation: See ["Data Source"](#) on page 279

```
[:SOURce<hw>]:BB:EUTRa:UL:UE<st>:SL:DSElect <DataList>
```

Selects an existing data list file from the default directory or from the specific directory.

Parameters:

```
<DataList>      string
                 Filename incl. file extension or complete file path
```

Example:

```
MME:CDIR "/var/user/"
SOURce1:BB:EUTRa:UL:UE1:SL:DATA DLISt
SOURce1:BB:EUTRa:UL:UE1:SL:DSElect "lte.dm_iqd"
```

Manual operation: See ["Data Source"](#) on page 279

```
[:SOURce<hw>]:BB:EUTRa:UL:UE<st>:SL:PATTErn <Pattern>, <BitCount>
```

Sets a bit pattern as data source.

Parameters:

```
<Pattern>       numeric
                 *RST:    #H0

<BitCount>     integer
                 Range:   1 to 64
                 *RST:    1
```

Example:

```
SOURce1:BB:EUTRa:UL:UE1:SL:DATA PATT
SOURce1:BB:EUTRa:UL:UE1:SL:PATTErn #H2B8,11
```

Manual operation: See ["Data Source"](#) on page 279

```
[:SOURce<hw>]:BB:EUTRa:UL:UE<st>:SL:REStart <RestartEveryTra>
```

If enabled, the data source is restarted at each SL transmission.

Parameters:

```
<RestartEveryTra> 1 | ON | 0 | OFF
*RST:             0
```

Example: See [Example"Enabling sidelink transmission in communication mode"](#) on page 770.

Manual operation: See ["Restart Data every Transmission"](#) on page 280

[:SOURCE<hw>]:BB:EUTRa:UL:UE<st>:SL:RDISc:CPERiod <ControlPeriod>

Sets the period over which resources are allocated for sidelink control period (SC period).

Parameters:

<ControlPeriod> 32 | 64 | 128 | 256 | 512 | 1024
*RST: 32

Example: See [Example"Enabling sidelink transmission in discovery mode"](#) on page 772.

Manual operation: See ["Control Period"](#) on page 282

[:SOURCE<hw>]:BB:EUTRa:UL:UE<st>:SL:RCTRI:CPERiod <ControlPeriod>

Sets the period over which resources are allocated for sidelink control period (SC period).

Parameters:

<ControlPeriod> 40 | 60 | 70 | 80 | 120 | 140 | 160 | 240 | 280 | 320
*RST: 40

Example: See [Example"Enabling sidelink transmission in communication mode"](#) on page 770.

Manual operation: See ["Control Period"](#) on page 282

[:SOURCE<hw>]:BB:EUTRa:UL:UE<st>:SL:RDATa:OFFSetind <OffsetIndicator>

[:SOURCE<hw>]:BB:EUTRa:UL:UE<st>:SL:RDISc:OFFSetind <OffsetIndicator>

Sets the offset from the SFN=0 after that the SL control region starts.

Parameters:

<OffsetIndicator> integer
Range: 0 to 10239
*RST: 0

Example: See [Example"Enabling sidelink transmission in discovery mode"](#) on page 772.

Manual operation: See ["Offset Indicator"](#) on page 282

[:SOURCE<hw>]:BB:EUTRa:UL:UE<st>:SL:V2X:OFFSet <OffsetIndicator>

[:SOURCE<hw>]:BB:EUTRa:UL:UE<st>:SL:RCTRI:OFFSetind <OffsetIndicator>

Sets the offset from the SFN=0 after that the SL control region starts.

Parameters:

<OffsetIndicator> integer
 Range: 0 to 319
 *RST: 0

Example: See [Example"Enabling sidelink transmission in communication mode"](#) on page 770.

Manual operation: See ["Offset Indicator"](#) on page 282

```
[ :SOURce<hw>]:BB:EUTRa:UL:UE<st>:SL:RDATa:PRBStart <PrbStart>
[:SOURce<hw>]:BB:EUTRa:UL:UE<st>:SL:RDATa:PREnd <PrbEnd>
[:SOURce<hw>]:BB:EUTRa:UL:UE<st>:SL:RDISc:PRBStart <PrbStart>
[:SOURce<hw>]:BB:EUTRa:UL:UE<st>:SL:RDISc:PREnd <PrbEnd>
[:SOURce<hw>]:BB:EUTRa:UL:UE<st>:SL:RCTRI:PRBStart <PrbStart>
[:SOURce<hw>]:BB:EUTRa:UL:UE<st>:SL:RCTRI:PREnd <PrbEnd>
```

Sets the parameters `prb-Start` and `prb-End` and define allocation of the two SL bands.

Parameters:

<PrbEnd> integer
 Range: 0 to 99
 *RST: 99

Example: See [Example"Enabling sidelink transmission in communication mode"](#) on page 770.

Manual operation: See ["PRB Start, PRB End"](#) on page 283

```
[ :SOURce<hw>]:BB:EUTRa:UL:UE<st>:SL:RDATa:PRBNumber <PrbNumber>
[:SOURce<hw>]:BB:EUTRa:UL:UE<st>:SL:RDISc:PRBNumber <PrbNumber>
[:SOURce<hw>]:BB:EUTRa:UL:UE<st>:SL:RCTRI:PRBNumber <PrbNumber>
```

Sets the number of resource blocks each of the SL bands occupies.

Parameters:

<PrbNumber> integer
 Range: 1 to 100
 *RST: 1

Example: See [Example"Enabling sidelink transmission in communication mode"](#) on page 770.

Manual operation: See ["PRB Number"](#) on page 283

```
[ :SOURce<hw>]:BB:EUTRa:UL:UE<st>:SL:RDATa:SFBMp <Pattern>, <BitCount>
[:SOURce<hw>]:BB:EUTRa:UL:UE<st>:SL:RDISc:SFBMp <Pattern>, <BitCount>
[:SOURce<hw>]:BB:EUTRa:UL:UE<st>:SL:RCTRI:SFBMp <Pattern>, <BitCount>
```

Sets the subframe bitmap.

Parameters:

<Pattern> numeric
 *RST: #H0

<BitCount> integer
 Range: 1 to 42
 *RST: 1

Example: See [Example"Enabling sidelink transmission in communication mode"](#) on page 770.

Manual operation: See ["Control Subframe Bitmap/Subframe Bitmap"](#) on page 283

[:SOURCE<hw>]:BB:EUTRa:UL:UE<st>:SL:RDISc:NRETrans <NumRetrans>

Sets the number of PSDCH retransmissions.

Parameters:

<NumRetrans> integer
 Range: 0 to 3
 *RST: 0

Example: See [Example"Enabling sidelink transmission in discovery mode"](#) on page 772.

Manual operation: See ["Number of Retransmission"](#) on page 284

[:SOURCE<hw>]:BB:EUTRa:UL:UE<st>:SL:RDISc:NREPetitions <NumRepetitions>

Sets the number of PSDCH repetitions.

Parameters:

<NumRepetitions> integer
 Range: 1 to 50
 *RST: 1

Example: See [Example"Enabling sidelink transmission in discovery mode"](#) on page 772.

Manual operation: See ["Number of Repetitions"](#) on page 284

[:SOURCE<hw>]:BB:EUTRa:UL:UE<st>:SL:RDISc:N1PDsch <N1PDsch>

Sets the PDSCH resource index.

Parameters:

<N1PDsch> integer
 Range: 1 to 200
 *RST: 1

Example: See [Example"Enabling sidelink transmission in discovery mode"](#) on page 772.

Manual operation: See ["N\(1\)PDSCH/N\(2\)PDSCH/N\(3\)PDSCH"](#) on page 284

[:SOURce<hw>]:BB:EUTRa:UL:UE<st>:SL:RDISc:N2PDsch <N2PDsch>

Sets the PDSCH resource index.

Parameters:

<N2PDsch> integer
 Range: 1 to 10
 *RST: 1

Example: See [Example"Enabling sidelink transmission in discovery mode"](#) on page 772.

Manual operation: See ["N\(1\)PDSCH/N\(2\)PDSCH/N\(3\)PDSCH"](#) on page 284

[:SOURce<hw>]:BB:EUTRa:UL:UE<st>:SL:RDISc:N3PDsch <N3PDsch>

Sets the PDSCH resource index.

Parameters:

<N3PDsch> 1 | 5
 *RST: 1

Example: See [Example"Enabling sidelink transmission in discovery mode"](#) on page 772.

Manual operation: See ["N\(1\)PDSCH/N\(2\)PDSCH/N\(3\)PDSCH"](#) on page 284

[:SOURce<hw>]:BB:EUTRa:UL:UE<st>:SL:V2X:BMPLength <BmpLength>

Sets the bitmap length.

To set the subframe bitmap, use the commands [\[:SOURce<hw>\]:BB:EUTRa:UL:UE<st>:SL:V2X:BITLow](#) and [\[:SOURce<hw>\]:BB:EUTRa:UL:UE<st>:SL:V2X:BITHigh](#).

Parameters:

<BmpLength> 10 | 16 | 20 | 30 | 40 | 50 | 60 | 100
 *RST: 16

Example: See [Example"Enabling sidelink transmission in V2X mode"](#) on page 773.

Options: R&S SMM-K119

Manual operation: See ["Subframe Bitmap Length"](#) on page 285

[:SOURce<hw>]:BB:EUTRa:UL:UE<st>:SL:V2X:BITLow <Pattern>, <BitCount>

Sets the subframe bitmap.

[:SOURce<hw>]:BB:EUTRa:UL:UE<st>:SL:V2X:BITLow is enabled, if [:SOURce<hw>]:BB:EUTRa:UL:UE<st>:SL:V2X:BMPLength 10|16|20|30|40|50.

Parameters:

<Pattern> numeric
 *RST: #H0

<BitCount> integer
 Range: 10 to 50
 *RST: 16

Manual operation: See "Subframe Bitmap (0-49, bin)/Subframe Bitmap (50-99, bin)" on page 285

[:SOURce<hw>]:BB:EUTRa:UL:UE<st>:SL:V2X:BITHigh <Pattern>, <BitCount>

Sets the subframe bitmap.

[:SOURce<hw>]:BB:EUTRa:UL:UE<st>:SL:V2X:BITHigh is enabled, if [:SOURce<hw>]:BB:EUTRa:UL:UE<st>:SL:V2X:BMPLength 60|100.

Parameters:

<Pattern> numeric
 *RST: #H0

<BitCount> integer
 Range: 0 to 50
 *RST: 0

Example: See [Example "Enabling sidelink transmission in V2X mode"](#) on page 773.

Options: R&S SMM-K119

Manual operation: See "Subframe Bitmap (0-49, bin)/Subframe Bitmap (50-99, bin)" on page 285

[:SOURce<hw>]:BB:EUTRa:UL:UE<st>:SL:V2X:ADJC <Adjacency>

If enabled, the PSCCH and PSSCH channels are allocated on contiguous resources.

Parameters:

<Adjacency> 1 | ON | 0 | OFF
 *RST: 1

Example: See [Example "Enabling sidelink transmission in V2X mode"](#) on page 773.

Options: R&S SMM-K119

Manual operation: See "Adjacent PSCCH/PSSCH" on page 286

[[:SOURce<hw>]:BB:EUTRa:UL:UE<st>:SL:V2X:SUBChannels <NumSubchannels>

Sets the number of subchannels.

Parameters:

<NumSubchannels> 1 | 3 | 5 | 8 | 10 | 15 | 20
 *RST: 1

Example: See [Example"Enabling sidelink transmission in V2X mode"](#) on page 773.

Options: R&S SMM-K119

Manual operation: See ["Number of Subchannels"](#) on page 286

[[:SOURce<hw>]:BB:EUTRa:UL:UE<st>:SL:V2X:SRBSubchan <StartRbSubchan>

Sets the first RB in the subchannel.

Parameters:

<StartRbSubchan> integer
 Range: 0 to 99
 *RST: 0

Example: See [Example"Enabling sidelink transmission in V2X mode"](#) on page 773.

Options: R&S SMM-K119

Manual operation: See ["Start RB Subchannel"](#) on page 286

[[:SOURce<hw>]:BB:EUTRa:UL:UE<st>:SL:V2X:SUBSize <SubchannelSize>

Sets the number of resource blocks the subchannel spans.

Parameters:

<SubchannelSize> 4 | 5 | 6 | 8 | 9 | 10 | 12 | 15 | 16 | 18 | 20 | 25 | 30 | 48 | 50 | 72 |
 96 | 75 | 100 | 32
 *RST: 5

Example: See [Example"Enabling sidelink transmission in V2X mode"](#) on page 773.

Options: R&S SMM-K119

Manual operation: See ["Subchannel Size"](#) on page 286

[[:SOURce<hw>]:BB:EUTRa:UL:UE<st>:SL:RDISc:SFIndex <SfIndex>

Sets the subframe index.

Parameters:

<SfIndex> integer
 Range: 0 to 209
 *RST: 0

Example: See [Example"Enabling sidelink transmission in discovery mode"](#) on page 772.

Manual operation: See ["Subframe Index"](#) on page 284

[:SOURCE<hw>]:BB:EUTRa:UL:UE<st>:SL:RDISc:PRIndex <PrbIndex>

Sets the physical resource block index.

Parameters:

<PrbIndex> integer
 Range: 0 to 49
 *RST: 0

Example: See [Example"Enabling sidelink transmission in discovery mode"](#) on page 772.

Manual operation: See ["PRB Index"](#) on page 284

[:SOURCE<hw>]:BB:EUTRa:UL:UE<st>:SL:RDATa:TRPTsubset <TrptSubset>

The TRTP subset is a time resources pattern that indicates the set of available subframes to be used for sidelink communication.

Parameters:

<TrptSubset> 5 bits

Example: See [Example"Enabling sidelink transmission in communication mode"](#) on page 770.

Manual operation: See ["TRPT Subset"](#) on page 289

[:SOURCE<hw>]:BB:EUTRa:UL:UE<st>:SL:RDATa:HOPpingparam
 <HoppingParam>

Sets the frequency hopping parameter.

Parameters:

<HoppingParam> integer
 Range: 0 to 504
 *RST: 0

Manual operation: See ["Hopping Parameter"](#) on page 289

[:SOURCE<hw>]:BB:EUTRa:UL:UE<st>:SL:RDATa:NSUBbands <NumSubbands>

Sets the number of subbands.

Parameters:

<NumSubbands> 1 | 2 | 4
 *RST: 1

Example: See [Example"Enabling sidelink transmission in communication mode"](#) on page 770.

Manual operation: See ["Number of Subbands"](#) on page 289

[:SOURce<hw>]:BB:EUTRa:UL:UE<st>:SL:RDATa:RBOffset <RbOffset>

Shifts the band in the frequency domain by the selected number of resource blocks (RB).

Parameters:

<RbOffset> integer
 Range: 0 to 98
 *RST: 0

Example: See [Example"Enabling sidelink transmission in communication mode"](#) on page 770.

Manual operation: See ["RB Offset"](#) on page 289

[:SOURce<hw>]:BB:EUTRa:UL:UE<st>:SL:SYNC:STATe <SlSyncState>

Enables the synchronization signals.

Parameters:

<SlSyncState> 1 | ON | 0 | OFF
 *RST: 0

Example: See [Example"Enabling sidelink transmission in communication mode"](#) on page 770.

Manual operation: See ["Synchronization State"](#) on page 292

[:SOURce<hw>]:BB:EUTRa:UL:UE<st>:SL:SYNC:INCoverage <InCoverage>

Sets the in-coverage flag.

Parameters:

<InCoverage> 1 | ON | 0 | OFF
 *RST: 0

Example: See [Example"Enabling sidelink transmission in communication mode"](#) on page 770.

Manual operation: See ["In-coverage Flag"](#) on page 293

[:SOURCE<hw>]:BB:EUTRa:UL:UE<st>:SL:SYNC:SLSSid <SlssId>

Sets the sidelink synchronization signal ID.

Parameters:

<SlssId> integer
 Range: 0 to 335
 *RST: 0

Example: See [Example"Enabling sidelink transmission in communication mode"](#) on page 770.

Manual operation: See ["SLSS ID"](#) on page 293

[:SOURCE<hw>]:BB:EUTRa:UL:UE<st>:SL:SYNC:OFFSetInd <OffsetInd>

Sets the parameter `syncOffsetIndicator`.

Parameters:

<OffsetInd> integer
 Range: 0 to 159
 *RST: 0

Example: See [Example"Enabling sidelink transmission in communication mode"](#) on page 770.

Manual operation: See ["Sync Offset Indicator"](#) on page 293

[:SOURCE<hw>]:BB:EUTRa:UL:UE<st>:SL:NSCI <SciNumConfigs>

Sets the number of SCI (SL control information) configurations.

Parameters:

<SciNumConfigs> integer
 Range: 0 to 49
 *RST: 0

Example: See [Example"Enabling sidelink transmission in discovery mode"](#) on page 772.

Manual operation: See ["Number of SCI Config"](#) on page 294

[:SOURCE<hw>]:BB:EUTRa:UL:UE<st>:SL:SCI<ch0>:TXMode <SciTxMode>

Sets the transmission mode of the SL transmission.

Parameters:

<SciTxMode> 1 | 2 | 3 | 4
 *RST: 1

Example: See [Example"Enabling sidelink transmission in communication mode"](#) on page 770.

Options: 3|4 require R&S SMM-K119

Manual operation: See ["SL Tx Mode"](#) on page 294

[:SOURCE<hw>]:BB:EUTRa:UL:UE<st>:SL:SCI<ch0>:PSCPeriod
<SciPscchPeriod>

Sets the PSCCH period.

Parameters:

<SciPscchPeriod> integer
Range: 0 to 99
*RST: 0

Example: See [Example"Enabling sidelink transmission in communication mode"](#) on page 770.

Manual operation: See ["PSCCH Period"](#) on page 295

[:SOURCE<hw>]:BB:EUTRa:UL:UE<st>:SL:SCI<ch0>:NPSCch <SciNPscch>

Sets the parameter n_PSCCH and determines the resources in the time and the frequency domain that a transmitting UE uses for the PSCCH transmission.

Parameters:

<SciNPscch> integer
Range: 0 to 2100
*RST: 0

Example: See [Example"Enabling sidelink transmission in communication mode"](#) on page 770.

Manual operation: See ["n_PSCCH"](#) on page 295

[:SOURCE<hw>]:BB:EUTRa:UL:UE<st>:SL:SCI<ch0>:SF?

Queries the subframe numbers of the subframes that can be used for SL transmission.

Return values:

<SciSF> string
List of SF numbers, separated by commas

Example: See [Example"Enabling sidelink transmission in communication mode"](#) on page 770.

Usage: Query only

Manual operation: See ["SF"](#) on page 295

[:SOURCE<hw>]:BB:EUTRa:UL:UE<st>:SL:SCI<ch0>:FORMat <SciFormat>

Queries the SCI (SL control information) format.

Parameters:

<SciFormat> 0
 *RST: 0

Example: See [Example"Enabling sidelink transmission in communication mode"](#) on page 770.

Manual operation: See ["SCI Format"](#) on page 296

[:SOURce<hw>]:BB:EUTRa:UL:UE<st>:SL:SCI<ch0>:STARtsf <StartSf>

Sets the first subframe used for the SL transmission.

Parameters:

<StartSf> integer
 Range: 0 to 655650
 *RST: 0

Example: See [Example"Enabling sidelink transmission in V2X mode"](#) on page 773.

Options: R&S SMM-K119

Manual operation: See ["Start SF"](#) on page 295

[:SOURce<hw>]:BB:EUTRa:UL:UE<st>:SL:SCI<ch0>:SUBChannel <Subchannel>

Sets the used subchannel.

Parameters:

<Subchannel> integer
 Range: 0 to 19
 *RST: 0

Example: See [Example"Enabling sidelink transmission in V2X mode"](#) on page 773.

Options: R&S SMM-K119

Manual operation: See ["Subchannel"](#) on page 295

[:SOURce<hw>]:BB:EUTRa:UL:UE<st>:SL:SCI<ch0>:BITData?

Queries the resulting bit data as configured with the

[:SOURce<hw>]:BB:EUTRa:UL:UE<st>:SL:SCI<ch0> commands.

Return values:

<BitData> bit pattern

Example: See [Example"Enabling sidelink transmission in communication mode"](#) on page 770.

Usage: Query only

Manual operation: See ["Bit Data"](#) on page 296

[:SOURCE<hw>]:BB:EUTRa:UL:UE<st>:SL:SCI<ch0>:FHFLag <SIFreqHopping>

Sets the DCI field frequency hopping flag. If enabled, frequency hopping is used for the PSSCH transmission.

Parameters:

<SIFreqHopping> 1 | ON | 0 | OFF
 *RST: 0

Example: See [Example"Enabling sidelink transmission in communication mode"](#) on page 770.

**[:SOURCE<hw>]:BB:EUTRa:UL:UE<st>:SL:SCI<ch0>:RBAHoppalloc
 <RbaAndHoppAlloc>**

Sets the DCI field resource block (RBA) and hopping resource allocation.

This field identifies which resource blocks, within the subframes indicated by the time resource pattern ITRP, are used for PSSCH transmission.

Parameters:

<RbaAndHoppAlloc> integer
 Range: 0 to 8191
 *RST: 0

Example: See [Example"Enabling sidelink transmission in communication mode"](#) on page 770.

[:SOURCE<hw>]:BB:EUTRa:UL:UE<st>:SL:SCI<ch0>:TRP <TimeResPattern>

Sets the DCI field time resource pattern (ITPR).

Parameters:

<TimeResPattern> integer
 Range: 0 to 127
 *RST: 0

Example: See [Example"Enabling sidelink transmission in communication mode"](#) on page 770.

[:SOURCE<hw>]:BB:EUTRa:UL:UE<st>:SL:SCI<ch0>:MCS <ModCodScheme>

Sets the 5-bits indicator of the modulation and coding scheme (MSC) used for the PSSCH transmission.

Parameters:

<ModCodScheme> integer
 Range: 0 to 31
 *RST: 0

Example: See [Example"Enabling sidelink transmission in communication mode"](#) on page 770.

[:SOURCE<hw>]:BB:EUTRa:UL:UE<st>:SL:SCI<ch0>:TAINd <TimingAdvanceIn>

Sets the 11-bits timing advance indicator.

Parameters:

<TimingAdvanceIn> integer
 Range: 0 to 2047
 *RST: 0

Example: See [Example"Enabling sidelink transmission in communication mode"](#) on page 770.

[:SOURCE<hw>]:BB:EUTRa:UL:UE<st>:SL:SCI<ch0>:GRID <GroupDestID>

Sets the 8-bits group destination ID, indicating the group for which the sidelink communication is intended.

Parameters:

<GroupDestID> integer
 Range: 0 to 255
 *RST: 0

Example: See [Example"Enabling sidelink transmission in communication mode"](#) on page 770.

[:SOURCE<hw>]:BB:EUTRa:UL:UE<st>:SL:SCI<ch0>:FREQresloc
 <FreqResLocation>

Sets the frequency resource location of initial transmission and retransmission field.

Parameters:

<FreqResLocation> integer
 Range: 0 to 255
 *RST: 0

Example: See [Example"Enabling sidelink transmission in V2X mode"](#) on page 773.

Options: R&S SMM-K119

[:SOURCE<hw>]:BB:EUTRa:UL:UE<st>:SL:SCI<ch0>:PRIRity <Priority>

Sets the priority field.

Parameters:

<Priority> integer
 Range: 0 to 7
 *RST: 0

Example: See [Example"Enabling sidelink transmission in V2X mode"](#) on page 773.

Options: R&S SMM-K119

[:SOURCE<hw>]:BB:EUTRa:UL:UE<st>:SL:SCI<ch0>:RREServation
 <ResReservation>

Sets the resource reservation field.

Parameters:

<ResReservation> integer
 Range: 0 to 12
 *RST: 0

Example: See [Example"Enabling sidelink transmission in V2X mode"](#) on page 773.

Options: R&S SMM-K119

[:SOURCE<hw>]:BB:EUTRa:UL:UE<st>:SL:SCI<ch0>:TIMGap <TimeGap>

Sets the field time gap between initial transmission and the retransmission.

Parameters:

<TimeGap> integer
 Sets the time gap Sf_{gap} , where $Sf_{gap} = 0$ indicates single transmission.
 Range: 0 to 15
 *RST: 0

Example: See [Example"Enabling sidelink transmission in V2X mode"](#) on page 773.

Options: R&S SMM-K119

[:SOURCE<hw>]:BB:EUTRa:UL:UE<st>:SL:SCI<ch0>:TXIndex <TxIndex>

Specifies the retransmission index field.

Parameters:

<TxIndex> 1 | ON | 0 | OFF
 *RST: 0

Example: See [Example"Enabling sidelink transmission in V2X mode"](#) on page 773.

Options: R&S SMM-K119

[:SOURCE<hw>]:BB:EUTRa:UL:UE<st>:SL:NALLoc <NumTransmission>

In discovery mode, sets the number of sidelink transmissions.

Parameters:

<NumTransmission> integer
 Range: 0 to 100
 *RST: 0

Example: See [Example"Enabling sidelink transmission in discovery mode"](#) on page 772.

Manual operation: See ["Number of Transmissions"](#) on page 300

[:SOURCE<hw>]:BB:EUTRa:UL:UE<st>:SL:ALLoc<ch0>:CONTENT?

Queries the allocation content.

Return values:

<Content> PSCCh | PSSCh | PSDCh | PSBCh
 *RST: PSCCh

Example: See [Example"Enabling sidelink transmission in communication mode"](#) on page 770.

Usage: Query only

Manual operation: See ["Content"](#) on page 301

[:SOURCE<hw>]:BB:EUTRa:UL:UE<st>:SL:ALLoc<ch0>:DISCtype
<DiscoveryType>

In discovers mode, sets one of the discovery types, type 1 or type 2B.

Parameters:

<DiscoveryType> D1 | D2B
 *RST: D1

Example: See [Example"Enabling sidelink transmission in discovery mode"](#) on page 772.

Manual operation: See ["Discovery Type"](#) on page 301

[:SOURCE<hw>]:BB:EUTRa:UL:UE<st>:SL:ALLoc<ch0>:PSDPeriod
<PsdchPeriod>

In discovery mode, sets the period of the PSDCH.

Parameters:

<PsdchPeriod> integer
 Range: 0 to 100
 *RST: 0

Example: See [Example"Enabling sidelink transmission in discovery mode"](#) on page 772.

Manual operation: See ["PSDCH Period"](#) on page 301

[:SOURCE<hw>]:BB:EUTRa:UL:UE<st>:SL:ALLoc<ch0>:NPDSch <NPsdch>

In discovery mode and depending on the discovery type, sets one of the parameters:

- n_PSDCH applies for discovery type 1
- n' - for discovery type 2B.

Parameters:

<NPsdch> integer
 Range: 0 to 2100
 *RST: 0

Example: See [Example"Enabling sidelink transmission in discovery mode"](#) on page 772.

Manual operation: See "[n_PSDCH/n](#)" on page 301

[:SOURCE<hw>]:BB:EUTRa:UL:UE<st>:SL:ALLoc<ch0>:SF?

Queries the subframe numbers of the allocated subframe.

Return values:

<SF> string

Example: See [Example"Enabling sidelink transmission in communication mode"](#) on page 770.

Usage: Query only

Manual operation: See "[SF](#)" on page 301

[:SOURCE<hw>]:BB:EUTRa:UL:UE<st>:SL:ALLoc<ch0>:MODulation?

Queries the used modulation scheme.

Return values:

<Modulation> QPSK | QAM16 | QAM64
 *RST: QPSK

Example: See [Example"Enabling sidelink transmission in communication mode"](#) on page 770.

Usage: Query only

Options: R&S SMM-K119 for QAM64

Manual operation: See "[Modulation](#)" on page 302

[:SOURCE<hw>]:BB:EUTRa:UL:UE<st>:SL:ALLoc<ch0>:PHYSbits?

Queries the number of physical bits occupied by the channel.

Return values:

<PhysBits> integer
 Range: 0 to 1E5
 *RST: 0

Example: See [Example"Enabling sidelink transmission in communication mode"](#) on page 770.

Usage: Query only

Manual operation: See ["Physical Bits"](#) on page 302
 See ["Number of Physical Bits"](#) on page 304

[:SOURce<hw>]:BB:EUTRa:UL:UE<st>:SL:ALLoc<ch0>:POWer <Power>

Sets the power of the selected channel.

Parameters:

<Power> float
 Range: -80 to 10
 Increment: 0.001
 *RST: 0

Example: See [Example"Enabling sidelink transmission in communication mode"](#) on page 770.

Manual operation: See ["Power"](#) on page 302

[:SOURce<hw>]:BB:EUTRa:UL:UE<st>:SL:ALLoc<ch0>:STATe <State>

Enables the transmission of the selected channel.

Parameters:

<State> 1 | ON | 0 | OFF
 *RST: 0

Example: See [Example"Enabling sidelink transmission in communication mode"](#) on page 770.

Manual operation: See ["State"](#) on page 302

[:SOURce<hw>]:BB:EUTRa:UL:UE<st>:SL:ALLoc<ch0>:CONFLict?

Queries if there is a conflict.

Return values:

<Conflict> 1 | ON | 0 | OFF
 *RST: 0

Example: See [Example"Enabling sidelink transmission in communication mode"](#) on page 770.

Usage: Query only

Manual operation: See ["Conflict"](#) on page 302

[:SOURCE<hw>]:BB:EUTRa:UL:UE<st>:SL:ALLoc<ch0>:CYCShift <CyclicShift>

Sets the cyclic shift used by the generation of the DRS (discovery reference signal) sequence.

Parameters:

<CyclicShift> integer
 Value range depends on the sidelink mode.
 In communication mode, cyclic shift of 0 is used.
 In V2X communication mode, the value for PSCCH is one of the following {0, 3, 6, 9}.
 Range: 0 to 9
 Increment: 3
 *RST: 0

Example: See [Example"Enabling sidelink transmission in communication mode"](#) on page 770.

Manual operation: See ["DMRS > Cyclic Shift"](#) on page 303

[:SOURCE<hw>]:BB:EUTRa:UL:UE<st>:SL:ALLoc<ch0>:SCRambling:STATE <ScramState>

Enables scrambling.

Parameters:

<ScramState> 1 | ON | 0 | OFF
 *RST: 0

Example: See [Example"Enabling sidelink transmission in communication mode"](#) on page 770.

Manual operation: See ["State"](#) on page 304

[:SOURCE<hw>]:BB:EUTRa:UL:UE<st>:SL:ALLoc<ch0>:CCODing:STATE <ChanCodState>

Enables channel coding.

Parameters:

<ChanCodState> 1 | ON | 0 | OFF

Example: See [Example"Enabling sidelink transmission in communication mode"](#) on page 770.

Manual operation: See ["State"](#) on page 304

[:SOURCE<hw>]:BB:EUTRa:UL:UE<st>:SL:ALLoc<ch0>:CCODing:TBSI?

Queries the transport block index.

Return values:

<ChanCodTBIndex> integer
 Range: 0 to 33
 *RST: 0

Example: See [Example"Enabling sidelink transmission in communication mode"](#) on page 770.

Usage: Query only

Manual operation: See ["Transport Block Index"](#) on page 304

[:SOURCE<hw>]:BB:EUTRa:UL:UE<st>:SL:ALLoc<ch0>:CCODing:TBSize?

Queries the transport block size.

Return values:

<ChanCodTBSize> integer
 Range: 0 to 75376
 *RST: 0

Example: See [Example"Enabling sidelink transmission in communication mode"](#) on page 770.

Usage: Query only

Manual operation: See ["Transport Block Size"](#) on page 304

[:SOURCE<hw>]:BB:EUTRa:UL:UE<st>:SL:RMC:STATE <RmcState>

Activates the selected RMC.

Parameters:

<RmcState> 1 | ON | 0 | OFF
 *RST: 0

Example: See [Example"Configuring RMC"](#) on page 775.

Manual operation: See ["State"](#) on page 291

[:SOURCE<hw>]:BB:EUTRa:UL:UE<st>:SL:RMC:RMC <Rmc>

Selects the RMC.

Parameters:

<Rmc> R821 | R822 | R823
 *RST: R821

Example: See [Example"Configuring RMC"](#) on page 775.

Manual operation: See ["RMC"](#) on page 291

[:SOURCE<hw>]:BB:EUTRa:UL:UE<st>:SL:RMC:ARBLocks?

Queries the allocated resource blocks.

Return values:

<AllocResBlocks> integer
Range: 0 to 48
*RST: 0

Example: See [Example"Configuring RMC"](#) on page 775.

Usage: Query only

Manual operation: See ["Allocated Resource Blocks"](#) on page 291

[:SOURCE<hw>]:BB:EUTRa:UL:UE<st>:SL:RMC:MODulation?

Queries the used modulation scheme.

Return values:

<RmcModulation> QPSK | QAM16 | QAM64 | QAM256 | QAM1024
*RST: QPSK

Example: See [Example"Configuring RMC"](#) on page 775.

Usage: Query only

Manual operation: See ["Modulation"](#) on page 291

[:SOURCE<hw>]:BB:EUTRa:UL:UE<st>:SL:RMC:PAYSize?

Queries the payload size.

Return values:

<PayloadSize> integer
Range: 3496 to 31704
*RST: 3496

Example: See [Example"Configuring RMC"](#) on page 775.

Usage: Query only

Manual operation: See ["Payload Size"](#) on page 291

[:SOURCE<hw>]:BB:EUTRa:UL:UE<st>:SL:RMC:PHYSbits?

Queries the number of physical bits per subframe.

Return values:

<RmcPhysBits> integer
Range: 11520 to 46080
*RST: 11520

Example: See [Example"Configuring RMC"](#) on page 775.

Usage: Query only

Manual operation: See "Physical Bits per Subframe" on page 291

10.27 eMTC/NB-IoT commands

Option: R&S SMM-K115

Programming examples

Example: NB-IoT anchor carrier in standalone mode

```
*RST
SOURCEl:BB:EUTRa:DUPLexing FDD
SOURCEl:BB:EUTRa:LINK DOWN
SOURCEl:BB:EUTRa:SLENgth 40
SOURCEl:BB:EUTRa:DL:BW BW0_20

// Antenna ports configuration
SOURCEl:BB:EUTRa:DL:MIMO:CONFIguration TX2
SOURCEl:BB:EUTRa:DL:MIMO:NIOT:CONFIg TX2
SOURCEl:BB:EUTRa:DL:MIMO:APM:MAPCoordinates CART
SOURCEl:BB:EUTRa:DL:MIMO:APM:CS:AP2000:ROW0:REAL 1
SOURCEl:BB:EUTRa:DL:MIMO:ANTenna ANT1

// PCI, NPSS and NSSF configuration
SOURCEl:BB:EUTRa:DL:PLCI:CID 100
SOURCEl:BB:EUTRa:DL:CARRier1:NIOT:CELL 200
SOURCEl:BB:EUTRa:DL:SYNC:TXANTenna ALL
SOURCEl:BB:EUTRa:DL:SYNC:NIOT:TXANTenna TX2
SOURCEl:BB:EUTRa:DL:SYNC:NIOT:TXANTenna ALL
SOURCEl:BB:EUTRa:DL:SYNC:NIOT:NPPWr 0
SOURCEl:BB:EUTRa:DL:SYNC:NIOT:NSPW r 0

// NB-IoT carrier configuration
SOURCEl:BB:EUTRa:DL:CARRier1:NIOT:MODE?
// ALON
SOURCEl:BB:EUTRa:DL:CARRier1:NIOT:STATE?
// 1
SOURCEl:BB:EUTRa:DL:CARRier1:NIOT:NVSF?
// N10
// enable all subframes
SOURCEl:BB:EUTRa:DL:CARRier1:NIOT:SFALL
SOURCEl:BB:EUTRa:DL:CARRier1:NIOT:SF0:VALSf?
// 0
// reserved for NPBCH
SOURCEl:BB:EUTRa:DL:CARRier1:NIOT:SF1:VALSf?
// 1
// common serach space configuration
SOURCEl:BB:EUTRa:DL:NIOT:PAG:RMAX R4
```

```
SOURcel:BB:EUTRa:DL:NIOT:RAND:RMAX R4
SOURcel:BB:EUTRa:DL:NIOT:RAND:STSFrame S4
SOURcel:BB:EUTRa:DL:NIOT:RAND:SSOffset 01_8
```

```
SOURcel:BB:EUTRa:STATe 1
```

Example: NB-LoT carriers in in-band mode

```
SOURcel:BB:EUTRa:DUPLexing FDD
SOURcel:BB:EUTRa:LINK DOWN
SOURcel:BB:EUTRa:SLENgth 40
SOURcel:BB:EUTRa:DL:BW BW5_00

SOURcel:BB:EUTRa:DL:NIOT:LTECell:STATe 1

// SOURcel:BB:EUTRa:DL:NIOT:GAP:CONFig:STATe 1
// SOURcel:BB:EUTRa:DL:NIOT:GAP:PERiodicity 64
// SOURcel:BB:EUTRa:DL:NIOT:GAP:THReshold 32
// SOURcel:BB:EUTRa:DL:NIOT:GAP:DURation:COEfficent 1_8

// Enabling the anchor carrier and one dummy carrier
SOURcel:BB:EUTRa:DL:CARRier1:NIOT:STATe 1
SOURcel:BB:EUTRa:DL:CARRier1:NIOT:MODE INBD
SOURcel:BB:EUTRa:DL:CARRier2:NIOT:MODE INBD
SOURcel:BB:EUTRa:DL:CARRier1:NIOT:RBIDx 2
SOURcel:BB:EUTRa:DL:CARRier1:NIOT:DFReq?
// -1807500
SOURcel:BB:EUTRa:DL:CARRier2:NIOT:RBIDx 7
SOURcel:BB:EUTRa:DL:CARRier2:NIOT:DFReq?
// -907500
SOURcel:BB:EUTRa:DL:CARRier1:NIOT:CRSSeq?
// 5
SOURcel:BB:EUTRa:DL:CARRier1:NIOT:CELL 200
SOURcel:BB:EUTRa:DL:CARRier1:NIOT:CIDGroup?
// 66
SOURcel:BB:EUTRa:DL:NIOT:ID?
// 2
SOURcel:BB:EUTRa:DL:CARRier1:NIOT:NVSF N40
SOURcel:BB:EUTRa:DL:CARRier1:NIOT:SFALL
SOURcel:BB:EUTRa:DL:CARRier2:NIOT:STATe 1
SOURcel:BB:EUTRa:DL:CARRier2:NIOT:NVSF N10
SOURcel:BB:EUTRa:DL:CARRier2:NIOT:SFALL

SOURcel:BB:EUTRa:DL:CARRier1:NIOT:SF0:VALSf?
// 0
// reserved for NPBCH
SOURcel:BB:EUTRa:DL:CARRier1:NIOT:SF1:VALSf?
// 1
// common search space configuration
SOURcel:BB:EUTRa:DL:NIOT:PAG:RMAX R4
SOURcel:BB:EUTRa:DL:NIOT:RAND:RMAX R4
```

```
SOURcel:BB:EUTRa:DL:NIOT:RAND:STSFrame S4
SOURcel:BB:EUTRa:DL:NIOT:RAND:SSOffset 01_8
```

```
SOURcel:BB:EUTRa:STATe 1
SOURcel:BB:EUTRa:SETTing:STORe "/var/user/iot_inband"
```

Example: NPRS part A+B configuration in in-band mode

Option: R&S SMM-K143

```
SOURcel:BB:EUTRa:DUPLexing FDD
SOURcel:BB:EUTRa:LINK DOWN
SOURcel:BB:EUTRa:SLENgth 40
SOURcel:BB:EUTRa:DL:BW BW5_00
```

```
SOURcel:BB:EUTRa:DL:CARRier1:NIOT:MODE INBD
SOURcel:BB:EUTRa:DL:NPRS:STATe 1
SOURcel:BB:EUTRa:DL:NPRS:CONF PA_AB
SOURcel:BB:EUTRa:DL:NPRS:POW 3
SOURcel:BB:EUTRa:DL:NPRS:ID 100
SOURcel:BB:EUTRa:DL:NPRS:SEIN 10
SOURcel:BB:EUTRa:DL:NPRS:BMP:CONF BMP_10
SOURcel:BB:EUTRa:DL:NPRS:BMP:VALSubframes1 0
SOURcel:BB:EUTRa:DL:NPRS:BMP:VALSubframes0 1
SOURcel:BB:EUTRa:DL:NPRS:MTIA #H6,3
// for NPRS Part B configuration
SOURcel:BB:EUTRa:DL:NPRS:PERD PD_160
SOURcel:BB:EUTRa:DL:NPRS:STSf STSF0_8
SOURcel:BB:EUTRa:DL:NPRS:SFNM SFNM_20
SOURcel:BB:EUTRa:DL:NPRS:MTIB?
```

Example: NB-IoT wake up signal

Option: R&S SMM-K146

```
SOURcel:BB:EUTRa:DL:NIOT:WUS:MAXDuration DN_256
SOURcel:BB:EUTRa:DL:NIOT:WUS:POW -40
SOURcel:BB:EUTRa:DL:NIOT:WUS:PSF?
SOURcel:BB:EUTRa:DL:NIOT:WUS:SF 0
SOURcel:BB:EUTRa:DL:NIOT:WUS:TO TO_80
SOURcel:BB:EUTRa:DL:NIOT:WUS:ACD DN_1
SOURcel:BB:EUTRa:DL:NIOT:WUS:STATe ON
```

Example: NB-LoT UE configuration

```

SOURCE1:BB:EUTRa:DL:USER1:RELease NIOT
// UE-specific search space
SOURCE1:BB:EUTRa:DL:USER1:NIOT:RMAX R4
SOURCE1:BB:EUTRa:DL:USER1:NIOT:STSFrame S1_5
SOURCE1:BB:EUTRa:DL:USER1:NIOT:SSOFFset 00
SOURCE1:BB:EUTRa:DL:USER1:UEID 50
SOURCE1:BB:EUTRa:DL:USER1:UEC?
// NB1
SOURCE1:BB:EUTRa:DL:USER1:CCODing:STATe?
// 1
SOURCE1:BB:EUTRa:DL:USER1:DATA PN9
// SOURCE1:BB:EUTRa:DL:USER1:DATA DLIS
// SOURCE1:BB:EUTRa:DL:USER1:DSElect "/var/user/UE1_NBLoT.dm_iqd"

```

Example: DCI format N0 configuration

DCI format N0 is used for scheduling of NPUSCH in one UL cell. If DCI format N0 is activated, one NPDCCH is configured and activated automatically.

```

SOURCE1:BB:EUTRa:DL:USER1:STHP:STATe 1

SOURCE1:BB:EUTRa:DL:NIOT:DCI:NALLoc 1

SOURCE1:BB:EUTRa:DL:NIOT:DCI:ALLoc0:USER USER1
SOURCE1:BB:EUTRa:DL:NIOT:DCI:ALLoc0:UEID?
// 50
SOURCE1:BB:EUTRa:DL:NIOT:DCI:ALLoc0:FMT N0
SOURCE1:BB:EUTRa:DL:NIOT:DCI:ALLoc0:SSP UE
SOURCE1:BB:EUTRa:DL:NIOT:DCI:ALLoc0:STSF 0
SOURCE1:BB:EUTRa:DL:NIOT:DCI:ALLoc0:STSF?
// 6
// first allowed subframe number is calculated automatically
SOURCE1:BB:EUTRa:DL:NIOT:DCI:ALLoc0:NPDCch:FMT?
// 1
SOURCE1:BB:EUTRa:DL:NIOT:DCI:ALLoc0:CCES?
// 2
SOURCE1:BB:EUTRa:DL:NIOT:DCI:ALLoc0:IDCCe?
// 0

SOURCE1:BB:EUTRa:DL:NIOT:DCI:ALLoc0:SCINd 2
SOURCE1:BB:EUTRa:DL:NIOT:DCI:ALLoc0:IRU 2
SOURCE1:BB:EUTRa:DL:NIOT:DCI:ALLoc0:IDELay 2
SOURCE1:BB:EUTRa:DL:NIOT:DCI:ALLoc0:MCSScheme 6
SOURCE1:BB:EUTRa:DL:NIOT:DCI:ALLoc0:RVERsion 1
SOURCE1:BB:EUTRa:DL:NIOT:DCI:ALLoc0:NDINd 0
SOURCE1:BB:EUTRa:DL:NIOT:DCI:ALLoc0:NPUSch:IREP 3
SOURCE1:BB:EUTRa:DL:NIOT:DCI:ALLoc0:SFRPt 2
SOURCE1:BB:EUTRa:DL:NIOT:DCI:ALLoc0:HPNMber 1
SOURCE1:BB:EUTRa:DL:NIOT:DCI:ALLoc0:NPDCch:REP?
// 4
SOURCE1:BB:EUTRa:DL:NIOT:DCI:ALLoc0:NRUNits?

```

```

// 3
SOURCE1:BB:EUTRA:DL:NIOT:DCI:ALLOC0:BITS?
// "000 0010 0101 0011 0101 1010"

// NPDCCH allocation is the third allocation
// NPBCH is always the first allocation
// NPDSCH carrying SIB1-NB is the second one
SOURCE1:BB:EUTRA:DL:NIOT:ALLOC2:CONType?
// NPDC
SOURCE1:BB:EUTRA:DL:NIOT:ALLOC2:MODulation?
// QPSK
SOURCE1:BB:EUTRA:DL:NIOT:ALLOC2:SFList?
// "6, 7, 8, 11"
SOURCE1:BB:EUTRA:DL:NIOT:ALLOC2:STSymbol SYM1
SOURCE1:BB:EUTRA:DL:NIOT:ALLOC2:PHYSbits?
// 232
SOURCE1:BB:EUTRA:DL:NIOT:ALLOC2:DATA?
// USER1
SOURCE1:BB:EUTRA:DL:NIOT:ALLOC2:POWER 0
SOURCE1:BB:EUTRA:DL:NIOT:ALLOC2:STATE?
// 1

SOURCE1:BB:EUTRA:DL:NIOT:ALLOC2:PRECoding:SCHEME TXD
SOURCE1:BB:EUTRA:DL:NIOT:ALLOC2:PRECoding:NOLayers?
// 2
SOURCE1:BB:EUTRA:DL:NIOT:ALLOC2:SCrambling:STATE 1
SOURCE1:BB:EUTRA:DL:NIOT:ALLOC2:CCODing:STATE 1
SOURCE1:BB:EUTRA:DL:NIOT:ALLOC2:CCODing:TBSIZE?
// 88

```

Example: NPDCCH and NPDSCH DCI-based configuration (DCI format N1)

```

SOURCE1:BB:EUTRA:DL:NIOT:DCI:NALLOC 1

SOURCE1:BB:EUTRA:DL:NIOT:DCI:ALLOC0:USER USER1
SOURCE1:BB:EUTRA:DL:NIOT:DCI:ALLOC0:UEID?
// 50
SOURCE1:BB:EUTRA:DL:NIOT:DCI:ALLOC0:FMT N1
SOURCE1:BB:EUTRA:DL:NIOT:DCI:ALLOC0:SSP UE
SOURCE1:BB:EUTRA:DL:NIOT:DCI:ALLOC0:STSF 6
// first allowed subframe number is calculated automatically
SOURCE1:BB:EUTRA:DL:NIOT:DCI:ALLOC0:NPDCch:FMT?
// 1
SOURCE1:BB:EUTRA:DL:NIOT:DCI:ALLOC0:CCES?
// 2
SOURCE1:BB:EUTRA:DL:NIOT:DCI:ALLOC0:IDCCe?
// 0

// SOURCE1:BB:EUTRA:DL:NIOT:DCI:ALLOC0:NPDCch:OIND 1
// SOURCE1:BB:EUTRA:DL:NIOT:DCI:ALLOC0:NPRach:SNUMBER 2
// SOURCE1:BB:EUTRA:DL:NIOT:DCI:ALLOC0:NPRach:SCIND 2

```

```

// SOURCE1:BB:EUTRA:DL:NIOT:DCI:ALLOC0:SFRPt 2
// SOURCE1:BB:EUTRA:DL:NIOT:DCI:ALLOC0:BITS?
// "111 0000 0101 1111 1111 1111"

SOURCE1:BB:EUTRA:DL:NIOT:DCI:ALLOC0:NPDCch:OIND 0
SOURCE1:BB:EUTRA:DL:NIOT:DCI:ALLOC0:IDELay 2
SOURCE1:BB:EUTRA:DL:NIOT:DCI:ALLOC0:NPDSch:ISF 2
SOURCE1:BB:EUTRA:DL:NIOT:DCI:ALLOC0:MCSScheme 4
SOURCE1:BB:EUTRA:DL:NIOT:DCI:ALLOC0:NPDSch:IREP 2
SOURCE1:BB:EUTRA:DL:NIOT:DCI:ALLOC0:NDIND 1
SOURCE1:BB:EUTRA:DL:NIOT:DCI:ALLOC0:HACK 1
SOURCE1:BB:EUTRA:DL:NIOT:DCI:ALLOC0:SFRPt 2
SOURCE1:BB:EUTRA:DL:NIOT:DCI:ALLOC0:NPDSch:NREP?
// 4
SOURCE1:BB:EUTRA:DL:NIOT:DCI:ALLOC0:NPDSch:NSF?
// 3
SOURCE1:BB:EUTRA:DL:NIOT:DCI:ALLOC0:TBSZ?
// 208
SOURCE1:BB:EUTRA:DL:NIOT:DCI:ALLOC0:BITS?
// "100 1001 0010 0001 0100 0110"

SOURCE1:BB:EUTRA:DL:NIOT:NALLOC?
// 4
// NPDCCH allocation is the third allocation
// NPBCH is always the first allocation
// NPDSCH carrying SIB1-NB is the second one
SOURCE1:BB:EUTRA:DL:CARRIER1:NIOT:RBIDx?
// 2
SOURCE1:BB:EUTRA:DL:NIOT:ALLOC2:CONType?
// NPDC
SOURCE1:BB:EUTRA:DL:NIOT:ALLOC2:MODulation?
// QPSK
SOURCE1:BB:EUTRA:DL:NIOT:ALLOC2:SFList?
// "6, 7, 8, 11"
SOURCE1:BB:EUTRA:DL:NIOT:ALLOC2:STSymbol SYM1
SOURCE1:BB:EUTRA:DL:NIOT:ALLOC2:PHYSbits?
// 256
SOURCE1:BB:EUTRA:DL:NIOT:ALLOC2:DATA?
// USER1
SOURCE1:BB:EUTRA:DL:NIOT:ALLOC2:POWer 0
SOURCE1:BB:EUTRA:DL:NIOT:ALLOC2:STAtE?
// 1
SOURCE1:BB:EUTRA:DL:NIOT:ALLOC2:CONFLICT?
// 0

SOURCE1:BB:EUTRA:DL:NIOT:ALLOC2:PRECoding:SCHEME TXD
SOURCE1:BB:EUTRA:DL:NIOT:ALLOC2:PRECoding:NOLayers?
// 2
SOURCE1:BB:EUTRA:DL:NIOT:ALLOC2:SCRambling:STAtE 1
SOURCE1:BB:EUTRA:DL:NIOT:ALLOC2:CCODing:STAtE 1

```



```
SOURce1:BB:EUTRa:DL:NIOT:ALLoc2:CCODing:TBSize?
// 208

// NPDSCH allocation is the fourth allocation
SOURce1:BB:EUTRa:DL:NIOT:ALLoc3:CONType?
// NPDS
SOURce1:BB:EUTRa:DL:NIOT:ALLoc3:SFList?
// "26, 27, 28, 31..."
SOURce1:BB:EUTRa:DL:NIOT:ALLoc3:PHYSbits?
// 232
SOURce1:BB:EUTRa:DL:NIOT:ALLoc3:DATA?
// USER1
SOURce1:BB:EUTRa:DL:NIOT:ALLoc3:STSymbol SYM3
SOURce1:BB:EUTRa:DL:NIOT:ALLoc3:POWer 0
SOURce1:BB:EUTRa:DL:NIOT:ALLoc3:STATe?
// 1
SOURce1:BB:EUTRa:DL:NIOT:ALLoc3:PRECODing:SCHEME NONE
SOURce1:BB:EUTRa:DL:NIOT:ALLoc3:SCRambling:STATe 1

SOURce1:BB:EUTRa:DL:NIOT:ALLoc3:SCRambling:LEGacy:STATe 0

SOURce1:BB:EUTRa:DL:NIOT:ALLoc3:SCRambling:UEID?
// 50
SOURce1:BB:EUTRa:DL:NIOT:ALLoc3:CCODing:STATe?
// 1
SOURce1:BB:EUTRa:DL:NIOT:ALLoc3:CCODing:ISF?
// 2
SOURce1:BB:EUTRa:DL:NIOT:ALLoc3:CCODing:NSF?
// 3
SOURce1:BB:EUTRa:DL:NIOT:ALLoc3:CCODing:TBSI?
// 4
SOURce1:BB:EUTRa:DL:NIOT:ALLoc3:CCODing:TBSize?
// 208
```

Example: DCI format N2 configuration

DCI format N2 is paging and direct indication. If DCI format N2 is activated, one NPDCCH is configured and activated automatically.

```

SOURCE1:BB:EUTRA:DL:NIOT:DCI:NALLOc 1
SOURCE1:BB:EUTRA:DL:NIOT:DCI:ALLOc0:USER PRNT
SOURCE1:BB:EUTRA:DL:NIOT:DCI:ALLOc0:UEID?
// 65534
SOURCE1:BB:EUTRA:DL:NIOT:DCI:ALLOc0:FMT?
// N2
SOURCE1:BB:EUTRA:DL:NIOT:DCI:ALLOc0:SSP?
// T1CM
SOURCE1:BB:EUTRA:DL:NIOT:DCI:ALLOc0:STSF 1
SOURCE1:BB:EUTRA:DL:NIOT:DCI:ALLOc0:NPDCch:FMT?
// 1
SOURCE1:BB:EUTRA:DL:NIOT:DCI:ALLOc0:CCES?
// 2
SOURCE1:BB:EUTRA:DL:NIOT:DCI:ALLOc0:IDCCe?
// 0

// SOURCE1:BB:EUTRA:DL:NIOT:DCI:ALLOc0:PAG 0
// SOURCE1:BB:EUTRA:DL:NIOT:DCI:ALLOc0:SIME 1
// SOURCE1:BB:EUTRA:DL:NIOT:DCI:ALLOc0:SINF 1
// SOURCE1:BB:EUTRA:DL:NIOT:DCI:ALLOc0:SFRPt 2

SOURCE1:BB:EUTRA:DL:NIOT:DCI:ALLOc0:PAG 1
SOURCE1:BB:EUTRA:DL:NIOT:DCI:ALLOc0:NPDSch:ISF 2
SOURCE1:BB:EUTRA:DL:NIOT:DCI:ALLOc0:MCSScheme 4
SOURCE1:BB:EUTRA:DL:NIOT:DCI:ALLOc0:NPDSch:IREP 2
SOURCE1:BB:EUTRA:DL:NIOT:DCI:ALLOc0:SFRPt 2
SOURCE1:BB:EUTRA:DL:NIOT:DCI:ALLOc0:TBSZ?
// 208
SOURCE1:BB:EUTRA:DL:NIOT:DCI:ALLOc0:NPDSch:NSF?
// 3
SOURCE1:BB:EUTRA:DL:NIOT:DCI:ALLOc0:NPDSch:NREP?
// 4
SOURCE1:BB:EUTRA:DL:NIOT:DCI:ALLOc0:NPDCch:REP?
// 4
SOURCE1:BB:EUTRA:DL:NIOT:DCI:ALLOc0:BITS?
// "101 0010 0001 0010"

```

Example: NPBCH and SIB1-NB configuration

```

SOURCE1:BB:EUTRA:DL:NIOT:ALLOc0:SFLIST?
// "0, 10, 20, 30..."
SOURCE1:BB:EUTRA:DL:NIOT:ALLOc0:STSYMBOL?
// SYM3
SOURCE1:BB:EUTRA:DL:NIOT:ALLOc0:PHYSBITS?
// 200
// NPBCH always uses 200 bits
SOURCE1:BB:EUTRA:DL:NIOT:ALLOc0:DATA?
// MIB
SOURCE1:BB:EUTRA:DL:NIOT:ALLOc0:POWER 1
SOURCE1:BB:EUTRA:DL:NIOT:ALLOc0:STATE?
// 1

SOURCE1:BB:EUTRA:DL:NIOT:ALLOc0:PRECODING:SCHEME NONE
SOURCE1:BB:EUTRA:DL:NIOT:ALLOc0:SCRAMBLING:STATE 1
SOURCE1:BB:EUTRA:DL:NIOT:ALLOc0:SCRAMBLING:SPROT 0
SOURCE1:BB:EUTRA:DL:NIOT:ALLOc0:PHYSBITS?
// 200
SOURCE1:BB:EUTRA:DL:NIOT:CCODING:MIB 1
SOURCE1:BB:EUTRA:DL:NIOT:CCODING:SOFFSET 16
SOURCE1:BB:EUTRA:DL:NIOT:CCODING:SIB 0
SOURCE1:BB:EUTRA:DL:NIOT:CCODING:RSIB?
// 4
SOURCE1:BB:EUTRA:DL:NIOT:CCODING:NCID?
// 200
// as set for the anchor carrier with the command
// SOURCE1:BB:EUTRA:DL:CARRIER1:NIOT:CELL
SOURCE1:BB:EUTRA:DL:NIOT:CCODING:STFSIB1?
// 0
SOURCE1:BB:EUTRA:DL:NIOT:CCODING:MSPARE #H000,11
SOURCE1:BB:EUTRA:DL:NIOT:ALLOc0:CCODING:TBSIZE?
// 34

SOURCE1:BB:EUTRA:DL:NIOT:ALLOc1:SFLIST?
// "4, 24, 44, 64..."
SOURCE1:BB:EUTRA:DL:NIOT:ALLOc1:STSYMBOL?
// SYM3
SOURCE1:BB:EUTRA:DL:NIOT:ALLOc1:PHYSBITS?
// 208
// numer of bits used by NPDSCH carrying SIB-NB
SOURCE1:BB:EUTRA:DL:NIOT:ALLOc1:DATA?
// SIB1
SOURCE1:BB:EUTRA:DL:NIOT:ALLOc1:STATE?
// 1

```

Example: NPDCCH and NPDSCH DCI-based configuration (DCI format N1)

```

SOURCE1:BB:EUTRa:DL:NIOT:DCI:NALLoc 1

SOURCE1:BB:EUTRa:DL:NIOT:DCI:ALLoc0:USER USER1
SOURCE1:BB:EUTRa:DL:NIOT:DCI:ALLoc0:UEID?
// 50
SOURCE1:BB:EUTRa:DL:NIOT:DCI:ALLoc0:FMT N1
SOURCE1:BB:EUTRa:DL:NIOT:DCI:ALLoc0:SSP UE
SOURCE1:BB:EUTRa:DL:NIOT:DCI:ALLoc0:STSF 6
// first allowed subframe number is calculated automatically
SOURCE1:BB:EUTRa:DL:NIOT:DCI:ALLoc0:NPDCch:FMT?
// 1
SOURCE1:BB:EUTRa:DL:NIOT:DCI:ALLoc0:CCES?
// 2
SOURCE1:BB:EUTRa:DL:NIOT:DCI:ALLoc0:IDCCe?
// 0

// SOURCE1:BB:EUTRa:DL:NIOT:DCI:ALLoc0:NPDCch:OIND 1
// SOURCE1:BB:EUTRa:DL:NIOT:DCI:ALLoc0:NPRach:SNUMber 2
// SOURCE1:BB:EUTRa:DL:NIOT:DCI:ALLoc0:NPRach:SCINd 2
// SOURCE1:BB:EUTRa:DL:NIOT:DCI:ALLoc0:SFRPt 2
// SOURCE1:BB:EUTRa:DL:NIOT:DCI:ALLoc0:BITS?
// "111 0000 0101 1111 1111 1111"

SOURCE1:BB:EUTRa:DL:NIOT:DCI:ALLoc0:NPDCch:OIND 0
SOURCE1:BB:EUTRa:DL:NIOT:DCI:ALLoc0:IDELay 2
SOURCE1:BB:EUTRa:DL:NIOT:DCI:ALLoc0:NPDSch:ISF 2
SOURCE1:BB:EUTRa:DL:NIOT:DCI:ALLoc0:MCSScheme 4
SOURCE1:BB:EUTRa:DL:NIOT:DCI:ALLoc0:NPDSch:IREP 2
SOURCE1:BB:EUTRa:DL:NIOT:DCI:ALLoc0:NDIND 1
SOURCE1:BB:EUTRa:DL:NIOT:DCI:ALLoc0:HACK 1
SOURCE1:BB:EUTRa:DL:NIOT:DCI:ALLoc0:SFRPt 2
SOURCE1:BB:EUTRa:DL:NIOT:DCI:ALLoc0:NPDSch:NREP?
// 4
SOURCE1:BB:EUTRa:DL:NIOT:DCI:ALLoc0:NPDSch:NSF?
// 3
SOURCE1:BB:EUTRa:DL:NIOT:DCI:ALLoc0:TBSZ?
// 208
SOURCE1:BB:EUTRa:DL:NIOT:DCI:ALLoc0:BITS?
// "100 1001 0010 0001 0100 0110"

SOURCE1:BB:EUTRa:DL:NIOT:NALLoc?
// 4
// NPDCCH allocation is the third allocation
// NPBCH is always the first allocation
// NPDSCH carrying SIB1-NB is the second one
SOURCE1:BB:EUTRa:DL:CARRIER1:NIOT:RBIDx?
// 2
SOURCE1:BB:EUTRa:DL:NIOT:ALLoc2:CONType?
// NPDC

```

```

SOURCE1:BB:EUTRa:DL:NIOT:ALLoc2:MODulation?
// QPSK
SOURCE1:BB:EUTRa:DL:NIOT:ALLoc2:SFList?
// "6, 7, 8, 11"
SOURCE1:BB:EUTRa:DL:NIOT:ALLoc2:STSymbol SYM1
SOURCE1:BB:EUTRa:DL:NIOT:ALLoc2:PHYSbits?
// 256
SOURCE1:BB:EUTRa:DL:NIOT:ALLoc2:DATA?
// USER1
SOURCE1:BB:EUTRa:DL:NIOT:ALLoc2:POWer 0
SOURCE1:BB:EUTRa:DL:NIOT:ALLoc2:STAtE?
// 1
SOURCE1:BB:EUTRa:DL:NIOT:ALLoc2:CONFLict?
// 0

SOURCE1:BB:EUTRa:DL:NIOT:ALLoc2:PRECoding:SCHEME TXD
SOURCE1:BB:EUTRa:DL:NIOT:ALLoc2:PRECoding:NOLayers?
// 2
SOURCE1:BB:EUTRa:DL:NIOT:ALLoc2:SCRambling:STAtE 1
SOURCE1:BB:EUTRa:DL:NIOT:ALLoc2:CCODing:STAtE 1
SOURCE1:BB:EUTRa:DL:NIOT:ALLoc2:CCODing:TBSize?
// 208

// NPDSCH allocation is the fourth allocation
SOURCE1:BB:EUTRa:DL:NIOT:ALLoc3:CONType?
// NPDS
SOURCE1:BB:EUTRa:DL:NIOT:ALLoc3:SFList?
// "26, 27, 28, 31..."
SOURCE1:BB:EUTRa:DL:NIOT:ALLoc3:PHYSbits?
// 232
SOURCE1:BB:EUTRa:DL:NIOT:ALLoc3:DATA?
// USER1
SOURCE1:BB:EUTRa:DL:NIOT:ALLoc3:STSymbol SYM3
SOURCE1:BB:EUTRa:DL:NIOT:ALLoc3:POWer 0
SOURCE1:BB:EUTRa:DL:NIOT:ALLoc3:STAtE?
// 1
SOURCE1:BB:EUTRa:DL:NIOT:ALLoc3:PRECoding:SCHEME NONE
SOURCE1:BB:EUTRa:DL:NIOT:ALLoc3:SCRambling:STAtE 1

SOURCE1:BB:EUTRa:DL:NIOT:ALLoc3:SCRambling:LEGacy:STAtE 0

SOURCE1:BB:EUTRa:DL:NIOT:ALLoc3:SCRambling:UEID?
// 50
SOURCE1:BB:EUTRa:DL:NIOT:ALLoc3:CCODing:STAtE?
// 1
SOURCE1:BB:EUTRa:DL:NIOT:ALLoc3:CCODing:ISF?
// 2
SOURCE1:BB:EUTRa:DL:NIOT:ALLoc3:CCODing:NSF?
// 3
SOURCE1:BB:EUTRa:DL:NIOT:ALLoc3:CCODing:TBSI?
// 4

```

```
SOURcel:BB:EUTRa:DL:NIOT:ALLoc3:CCODing:TBSize?
// 208
```

Example: NPUSCH and NDRS configuration

```
SOURcel:BB:EUTRa:STDMoDe IOT
SOURcel:BB:EUTRa:LiNK UP
SOURcel:BB:EUTRa:UL:BW BW1_40

SOURcel:BB:EUTRa:UL:UE1:STATe 1
SOURcel:BB:EUTRa:UL:UE1:RELease NIOT
SOURcel:BB:EUTRa:UL:UE1:MoDE STD
SOURcel:BB:EUTRa:UL:UE1:NIOT:SCSPacing S375
SOURcel:BB:EUTRa:UL:UE1:NIOT:MoDE INBD
SOURcel:BB:EUTRa:UL:UE1:NIOT:RBINdex 5
SOURcel:BB:EUTRa:UL:UE1:NIOT:DFReq?
// 450000
SOURcel:BB:EUTRa:UL:UE1:NIOT:NTRansmiss 2
SOURcel:BB:EUTRa:UL:UE1:NIOT:TRANs1:FORMat F1
SOURcel:BB:EUTRa:UL:UE1:NIOT:TRANs1:MoDulation PI4Q
SOURcel:BB:EUTRa:UL:UE1:NIOT:TRANs1:STSFrame 0
SOURcel:BB:EUTRa:UL:UE1:NIOT:TRANs1:REPetitions R1
SOURcel:BB:EUTRa:UL:UE1:NIOT:TRANs1:NRUNits RU1
SOURcel:BB:EUTRa:UL:UE1:NIOT:TRANs1:SIRF 10
SOURcel:BB:EUTRa:UL:UE1:NIOT:TRANs1:POW 0
SOURcel:BB:EUTRa:UL:UE1:NIOT:TRANs1:NSCarriers?
// 1
SOURcel:BB:EUTRa:UL:UE1:NIOT:TRANs1:NSLTs?
// 16
SOURcel:BB:EUTRa:UL:UE1:NIOT:TRANs1:STSCarrier?
// 10
SOURcel:BB:EUTRa:UL:UE1:NIOT:TRANs1:STSLot?
SOURcel:BB:EUTRa:UL:UE1:NIOT:TRANs2:FORMat F2
SOURcel:BB:EUTRa:UL:UE1:NIOT:TRANs2:MoDulation PI2B
SOURcel:BB:EUTRa:UL:UE1:NIOT:TRANs2:STSFrame 32
SOURcel:BB:EUTRa:UL:UE1:NIOT:TRANs2:REPetitions R2
SOURcel:BB:EUTRa:UL:UE1:NIOT:TRANs2:SIRF 0
SOURcel:BB:EUTRa:UL:UE1:NIOT:ARB:SUGGested?
// 5
SOURcel:BB:EUTRa:SLENgth 5

SOURcel:BB:EUTRa:UL:UE2:STATe 1
SOURcel:BB:EUTRa:UL:UE2:MoDE STD
SOURcel:BB:EUTRa:UL:UE2:RELease NIOT
SOURcel:BB:EUTRa:UL:UE2:NIOT:SCSPacing S15
SOURcel:BB:EUTRa:UL:UE2:NIOT:MoDE INBD
SOURcel:BB:EUTRa:UL:UE2:NIOT:RBINdex 5
SOURcel:BB:EUTRa:UL:UE2:NIOT:NTRansmiss 2
SOURcel:BB:EUTRa:UL:UE1:NIOT:TRANs1:FORMat F1
SOURcel:BB:EUTRa:UL:UE2:NIOT:TRANs1:MoDulation QPSK
SOURcel:BB:EUTRa:UL:UE2:NIOT:TRANs1:REPetitions R2
```

```

SOURCE1:BB:EUTRa:UL:UE2:NIOT:TRANS1:NRUnits RU3
SOURCE1:BB:EUTRa:UL:UE2:NIOT:TRANS1:SIRF 17
SOURCE1:BB:EUTRa:UL:UE2:NIOT:TRANS2:FORMat F2
SOURCE1:BB:EUTRa:UL:UE2:NIOT:TRANS2:STSFrame 12
SOURCE1:BB:EUTRa:UL:UE2:NIOT:TRANS2:REPetitions R4
SOURCE1:BB:EUTRa:UL:UE2:NIOT:TRANS2:SIRF 0

SOURCE1:BB:EUTRa:UL:UE1:NIOT:NPSSim 1
SOURCE1:BB:EUTRa:UL:UE1:CELL0:PUSCh:DATA PN9
SOURCE1:BB:EUTRa:UL:UE1:CELL0:PUSCh:SCRambling:STATe 1
SOURCE1:BB:EUTRa:UL:UE1:CELL0:PUSCh:CCODing:STATe 1
SOURCE1:BB:EUTRa:UL:UE1:NIOT:TRANS2:HARQ:PATtern #H1,1
SOURCE1:BB:EUTRa:UL:UE1:NIOT:TRANS2:HARQ:BITs?
// 1
SOURCE1:BB:EUTRa:UL:UE1:NIOT:TRANS2:HARQ:CBITs?
// 16

SOURCE1:BB:EUTRa:UL:UE1:NIOT:TRANS2:HARQ:SR 0

SOURCE1:BB:EUTRa:UL:UE1:NIOT:TRANS1:PUSCh:TBINdex 10
SOURCE1:BB:EUTRa:UL:UE1:NIOT:TRANS1:PUSCh:RVINdex 2
SOURCE1:BB:EUTRa:UL:UE1:NIOT:TRANS1:PUSCh:PHYSbits?
// 192
SOURCE1:BB:EUTRa:UL:UE1:NIOT:TRANS1:PUSCh:RUINdex?
// 0
SOURCE1:BB:EUTRa:UL:UE1:NIOT:TRANS1:PUSCh:TBSize?
// 144

SOURCE1:BB:EUTRa:UL:UE1:NIOT:TRANS1:PUSCh:ESUPport ON
SOURCE1:BB:EUTRa:UL:UE1:NIOT:TRANS1:PUSCh:ETBS 88

SOURCE1:BB:EUTRa:UL:UE1:CELL0:REFSig:DRS:POWoffset 0
SOURCE1:BB:EUTRa:UL:UE1:NIOT:GHDisable 0

SOURCE1:BB:EUTRa:UL:REFSig:DRS:GHOPping 1
SOURCE1:BB:EUTRa:UL:REFSig:DRS:DSEQshift 1
SOURCE1:BB:EUTRa:UL:REFSig:DRS:TTCShift 2
SOURCE1:BB:EUTRa:UL:REFSig:DRS:STCShift 3
SOURCE1:BB:EUTRa:UL:REFSig:DRS:USEBase 1
SOURCE1:BB:EUTRa:UL:REFSig:DRS:TTBSequence 10
SOURCE1:BB:EUTRa:UL:REFSig:DRS:STBSequence 11
SOURCE1:BB:EUTRa:UL:REFSig:DRS:TWBSequence 20

```

Example: NPRACH configuration

```

SOURCEl:BB:EUTRa:STDMoDe IOT
SOURCEl:BB:EUTRa:LiNK UP
SOURCEl:BB:EUTRa:UL:BW BW5_00
SOURCEl:BB:EUTRa:UL:PRACH:NIOT:PFMT F0
SOURCEl:BB:EUTRa:UL:PRACH:NIOT:CFG0:PERD 80
SOURCEl:BB:EUTRa:UL:PRACH:NIOT:CFG0:STTM 8
SOURCEl:BB:EUTRa:UL:PRACH:NIOT:CFG0:REP R2
SOURCEl:BB:EUTRa:UL:PRACH:NIOT:CFG0:SUBC 24
SOURCEl:BB:EUTRa:UL:PRACH:NIOT:CFG0:SCOF 2
SOURCEl:BB:EUTRa:UL:PRACH:NIOT:CFG1:REP R2
SOURCEl:BB:EUTRa:UL:PRACH:NIOT:CFG1:SUBC 24
SOURCEl:BB:EUTRa:UL:PRACH:NIOT:CFG1:SCOF 12
SOURCEl:BB:EUTRa:UL:PRACH:NIOT:CFG2:REP R16
SOURCEl:BB:EUTRa:UL:PRACH:NIOT:CFG2:SUBC 48
SOURCEl:BB:EUTRa:UL:UEl:RELEase NIOT
SOURCEl:BB:EUTRa:UL:UEl:MoDE PRAC
SOURCEl:BB:EUTRa:UL:UEl:PRACH:NIOT:MoD INBD
SOURCEl:BB:EUTRa:UL:UEl:PRACH:NIOT:RBID 24
SOURCEl:BB:EUTRa:UL:UEl:PRACH:NIOT:DFReq?
// 2.16 (value in MHz)
SOURCEl:BB:EUTRa:UL:UEl:PRACH:NIOT:PRATtempts 1
SOURCEl:BB:EUTRa:UL:UEl:PRACH:ATT0:NIOT:CoNFiG 0
SOURCEl:BB:EUTRa:UL:UEl:PRACH:ATT0:NIOT:SfStArt 8
SOURCEl:BB:EUTRa:UL:UEl:PRACH:ATT0:NIOT:POWeR 0
SOURCEl:BB:EUTRa:UL:UEl:PRACH:ATT0:NIOT:INIT 13
SOURCEl:BB:EUTRa:UL:UEl:PRACH:ATT0:NIOT:STRt?
// 14
SOURCEl:BB:EUTRa:UL:UEl:PRACH:NIOT:ARB:SUGGested?
// 2
SOURCEl:BB:EUTRa:SLENgth 2
SOURCEl:BB:EUTRa:STATe 1

```

Example: Using FRC

Activate a predefined fixed reference channel.

```

SOURCEl:BB:EUTRa:UL:UEl:RELEase NIOT
SOURCEl:BB:EUTRa:UL:UEl:NOIT:FRC:STATe 1
SOURCEl:BB:EUTRa:UL:UEl:NOIT:FRC:TYPe A141
SOURCEl:BB:EUTRa:UL:UEl:NOIT:FRC:SCSPacing?
// S15
SOURCEl:BB:EUTRa:UL:UEl:NOIT:FRC:NoSCarriers?
// 1
SOURCEl:BB:EUTRa:UL:UEl:NOIT:FRC:MoDulation?
// PI2Bpsk
SOURCEl:BB:EUTRa:UL:UEl:NOIT:FRC:NNPRep?
// 1
SOURCEl:BB:EUTRa:UL:UEl:NOIT:FRC:TBSSindex?
// 0

```



```

SOURCEl:BB:EUTRa:UL:UEl:NOIT:FRC:PASize?
// 32
SOURCEl:BB:EUTRa:UL:UEl:NOIT:FRC:ALResunits?
// 2
SOURCEl:BB:EUTRa:UL:UEl:NOIT:FRC:BPresunit?
// 96

```

Example: eMTC valid subframes and hopping configuration

```

SOURCEl:BB:EUTRa:DUPLexing FDD
SOURCEl:BB:EUTRa:LINK DOWN
SOURCEl:BB:EUTRa:STDMoDe IOT
SOURCEl:BB:EUTRa:SLENgth 40
SOURCEl:BB:EUTRa:DL:BW BW5_00

// set cell-specific settings
SOURCEl:BB:EUTRa:DL:PLCI:CID 110
SOURCEl:BB:EUTRa:DL:PLCI:CIDGroup 36
SOURCEl:BB:EUTRa:DL:PLCI:PLID 2
SOURCEl:BB:EUTRa:DL:CPC NORM
SOURCEl:BB:EUTRa:DL:PDsch:PB 1
SOURCEl:BB:EUTRa:DL:PBCH:RATBa 0
SOURCEl:BB:EUTRa:DL:CSEttings:RARnti 25
SOURCEl:BB:EUTRa:DL:REFSig:FPOWer 0

// PSS and SS settings
SOURCEl:BB:EUTRa:DL:SYnc:TXAntenna ALL
SOURCEl:BB:EUTRa:DL:SYnc:PPOWer 0
SOURCEl:BB:EUTRa:DL:SYnc:SPOWer 0

// eMTC valid subframes
SOURCEl:BB:EUTRa:DL:EMTC:BMP:SUBFrames 10
SOURCEl:BB:EUTRa:DL:EMTC:BMP:STARt 2
SOURCEl:BB:EUTRa:DL:EMTC:BMP:VALSubframes0 OFF
SOURCEl:BB:EUTRa:DL:EMTC:BMP:VALSubframes1 ON
// Alternatively, select all subframe setting them as valid.
SOURCEl:BB:EUTRa:DL:EMTC:BMP:SElectlall
// Deselect all subframe setting them to invalid.
SOURCEl:BB:EUTRa:DL:EMTC:BMP:DESelectlall

// PBCH scheduling and hopping
SOURCEl:BB:EUTRa:DL:EMTC:BMP:SIBBr 1
SOURCEl:BB:EUTRa:DL:EMTC:BMP:PBCHrep 1

// PDSCH and MPDCC hopping
SOURCEl:BB:EUTRa:DL:EMTC:NB:NNBands?
// 4
SOURCEl:BB:EUTRa:DL:EMTC:NB:HOPping 2
SOURCEl:BB:EUTRa:DL:EMTC:NB:HOFFset 1
SOURCEl:BB:EUTRa:DL:EMTC:NB:IVLA H1
SOURCEl:BB:EUTRa:DL:EMTC:NB:IVLB H2
SOURCEl:BB:EUTRa:DL:EMTC:NB:RHOPping 1
SOURCEl:BB:EUTRa:DL:EMTC:NB:PHOPping 1

```

```

SOURCE1:BB:EUTRa:DL:EMTC:NB:RSTNb 2
SOURCE1:BB:EUTRa:DL:EMTC:NB:PSTNb 2

// common search space configuration
SOURCE1:BB:EUTRa:DL:EMTC:SSP:MPD1 8
SOURCE1:BB:EUTRa:DL:EMTC:SSP:MPD2 16
SOURCE1:BB:EUTRa:DL:EMTC:SSP:STSF S1
SOURCE1:BB:EUTRa:DL:EMTC:SSP:PDSA 16
SOURCE1:BB:EUTRa:DL:EMTC:SSP:PDSB NON

// Transmission antennas and antenna port mapping
SOURCE1:BB:EUTRa:DL:MIMO:CONFIguration TX2
SOURCE1:BB:EUTRa:DL:MIMO:ANTenna ANT1

SOURCE1:BB:EUTRa:STATe 1
SOURCE1:BB:EUTRa:SETTING:STORe "/var/user/emtc_hopping"

```

Example: eMTC widebands configuration

Option: R&S SMM-K143

```

// UL
SOURCE1:BB:EUTRa:STDMoDe IOT
SOURCE1:BB:EUTRa:LINK UP
SOURCE1:BB:EUTRa:UL:BW BW10_00
SOURCE1:BB:EUTRa:UL:EMTC:WBCFg 1
SOURCE1:BB:EUTRa:UL:EMTC:NWBands?
// 2
SOURCE1:BB:EUTRa:UL:EMTC:VALId:SUBFrame1 1
SOURCE1:BB:EUTRa:UL:EMTC:RSYMBOL 2
SOURCE1:BB:EUTRa:UL:UE1:RELease EMTC
SOURCE1:BB:EUTRa:UL:UE1:STATe 1

SOURCE1:BB:EUTRa:UL:UE1:EMTC:NTRansmiss 1
SOURCE1:BB:EUTRa:UL:UE1:EMTC:TRANs1:CONTent PUSC
SOURCE1:BB:EUTRa:UL:UE1:EMTC:TRANs1:MODulation QPSK
SOURCE1:BB:EUTRa:UL:UE1:EMTC:TRANs1:STSFrame 0
SOURCE1:BB:EUTRa:UL:UE1:EMTC:TRANs1:REPetitions R2
SOURCE1:BB:EUTRa:UL:UE1:EMTC:TRANs1:STWBand 0
SOURCE1:BB:EUTRa:UL:UE1:EMTC:TRANs1:WRBLoCks CN6
SOURCE1:BB:EUTRa:UL:UE1:EMTC:TRANs1:WBRBoffset OS0
SOURCE1:BB:EUTRa:UL:UE1:EMTC:TRANs1:POW 0

// DL
// SOURCE1:BB:EUTRa:STDMoDe IOT
// SOURCE1:BB:EUTRa:LINK DOWN
// SOURCE1:BB:EUTRa:DL:BW BW10_00
// SOURCE1:BB:EUTRa:DL:EMTC:WBCFg BW5
// SOURCE1:BB:EUTRa:DL:EMTC:NWBands?
// 2

```

Example: eMTC UE configuration

```
// Transmission antennas and antenna port mapping
SOURCE1:BB:EUTRa:DL:MIMO:CONFIguration TX2
SOURCE1:BB:EUTRa:DL:MIMO:ANTenna ANT1

SOURCE1:BB:EUTRa:STDMode IOT
SOURCE1:BB:EUTRa:DL:USER1:RELease EM_A
SOURCE1:BB:EUTRa:DL:USER1:UEID 10
SOURCE1:BB:EUTRa:DL:USER1:UEC?
// M1
SOURCE1:BB:EUTRa:DL:USER1:CELL0:TXM M6
SOURCE1:BB:EUTRa:DL:USER1:CCODing:STATe?
// 1
SOURCE1:BB:EUTRa:DL:USER1:SCRambling:STATe 1
SOURCE1:BB:EUTRa:DL:USER1:DATA PN11
// SOURCE1:BB:EUTRa:DL:USER1:DATA DLIS
// SOURCE1:BB:EUTRa:DL:USER1:DSElect "/var/user/UE1_eMTC.dm_iqd"
```

Example: Configuring the MPDCCH sets

```
SOURCE1:BB:EUTRa:DUPLexing FDD
SOURCE1:BB:EUTRa:LINK DOWN
SOURCE1:BB:EUTRa:STDMode IOT

// enable an eMTC UE, e.g. supporting eMTC CE Mode A
SOURCE1:BB:EUTRa:DL:USER1:RELease EM_A

SOURCE1:BB:EUTRa:DL:USER1:EPDCch1:STATe 1
SOURCE1:BB:EUTRa:DL:USER1:EPDCch1:SET1:STATe 1
SOURCE1:BB:EUTRa:DL:USER1:EPDCch1:SET2:STATe 1

SOURCE1:BB:EUTRa:DL:USER1:EPDCch:CELL0:SET1:TTYP LOC
SOURCE1:BB:EUTRa:DL:USER1:EPDCch:CELL0:SET1:PRBS PRB2
SOURCE1:BB:EUTRa:DL:USER1:EPDCch:CELL0:SET1:RBA 2
SOURCE1:BB:EUTRa:DL:USER1:EPDCch:CELL0:SET1:NID 22
SOURCE1:BB:EUTRa:DL:USER1:EPDCch:CELL0:SET1:POWER 0
SOURCE1:BB:EUTRa:DL:USER1:EPDCch:CELL0:SET1:HOPPIng 1
SOURCE1:BB:EUTRa:DL:USER1:EPDCch:CELL0:SET1:STNB 1
SOURCE1:BB:EUTRa:DL:USER1:EPDCch:CELL0:SET1:REPMdcch 16
SOURCE1:BB:EUTRa:DL:USER1:EPDCch:CELL0:SET1:STSF S1

// MPDCCH allocations are configured automatically,
// depending on the eMTC DCI configuration
```

Example: MPDCCH and PDSCH DCI-based configuration (DCI format 6-1A)

The user UE1 is configured as described in [Example "eMTC UE configuration"](#) on page 815.

```

SOURCE1:BB:EUTRA:DL:EMTC:DCI:NALoc 1
// DCI configuration
SOURCE1:BB:EUTRA:DL:EMTC:DCI:ALLoc0:USER USER1
SOURCE1:BB:EUTRA:DL:EMTC:DCI:ALLoc0:UEID?
// 10
SOURCE1:BB:EUTRA:DL:EMTC:DCI:ALLoc0:MPDCchset MPD1
SOURCE1:BB:EUTRA:DL:EMTC:DCI:ALLoc0:FMT F61A
SOURCE1:BB:EUTRA:DL:EMTC:DCI:ALLoc0:SSP UE
SOURCE1:BB:EUTRA:DL:EMTC:DCI:ALLoc0:STSFrame 0
// first allowed subframe number is calculated automatically
SOURCE1:BB:EUTRA:DL:EMTC:DCI:ALLoc0:PDCCch 2
SOURCE1:BB:EUTRA:DL:EMTC:DCI:ALLoc0:IDCCe 1
SOURCE1:BB:EUTRA:DL:EMTC:DCI:ALLoc0:CCES?
// 4
SOURCE1:BB:EUTRA:DL:EMTC:DCI:ALLoc0:NDCCes?
// 4

// UE-specific search space for MPDCCH
SOURCE1:BB:EUTRA:DL:USER1:EPDCch:CELL0:SET1:HOPping 1
SOURCE1:BB:EUTRA:DL:USER1:EPDCch:CELL0:SET1:STNB 1
SOURCE1:BB:EUTRA:DL:USER1:EPDCch:CELL0:SET1:REPMdcch 16
SOURCE1:BB:EUTRA:DL:USER1:EPDCch:CELL0:SET1:STSF S1

// PDSCH configuration via DCI format 6-1A
SOURCE1:BB:EUTRA:DL:EMTC:DCI:ALLoc0:UEMode STD
SOURCE1:BB:EUTRA:DL:EMTC:DCI:ALLoc0:PFRHopp 1
SOURCE1:BB:EUTRA:DL:EMTC:DCI:ALLoc0:RBA 32
SOURCE1:BB:EUTRA:DL:EMTC:DCI:ALLoc0:MCS 5
SOURCE1:BB:EUTRA:DL:EMTC:DCI:ALLoc0:NREP 3
SOURCE1:BB:EUTRA:DL:EMTC:DCI:ALLoc0:HARQ 2
SOURCE1:BB:EUTRA:DL:EMTC:DCI:ALLoc0:NDInd 1
SOURCE1:BB:EUTRA:DL:EMTC:DCI:ALLoc0:RVER 2
SOURCE1:BB:EUTRA:DL:EMTC:DCI:ALLoc0:TPCPusch 1
// SOURCE1:BB:EUTRA:DL:EMTC:DCI:ALLoc0:DAIndex 2
SOURCE1:BB:EUTRA:DL:EMTC:DCI:ALLoc0:TPCPusch 2
SOURCE1:BB:EUTRA:DL:EMTC:DCI:ALLoc0:PMIConfirm 1
SOURCE1:BB:EUTRA:DL:EMTC:DCI:ALLoc0:TPMPrec 1
SOURCE1:BB:EUTRA:DL:EMTC:DCI:ALLoc0:CSIRequest 1
SOURCE1:BB:EUTRA:DL:EMTC:DCI:ALLoc0:SRSRequest 1
SOURCE1:BB:EUTRA:DL:EMTC:DCI:ALLoc0:HRESoffset 2
SOURCE1:BB:EUTRA:DL:EMTC:DCI:ALLoc0:SFRNumber 1
SOURCE1:BB:EUTRA:DL:EMTC:DCI:ALLoc0:BITS?
// "011 0101 0101 0101 0110 1010 1000 0011"
SOURCE1:BB:EUTRA:DL:EMTC:DCI:ALLoc0:TBS?
// 72
SOURCE1:BB:EUTRA:DL:EMTC:DCI:ALLoc0:REPMdcch?
// 4

```

```

SOURCE1:BB:EUTRa:DL:EMTC:DCI:ALLoc0:REPPdsch?
// 16
SOURCE1:BB:EUTRa:DL:EMTC:DCI:ALLoc0:PDSHopping?
// 1
SOURCE1:BB:EUTRa:DL:EMTC:DCI:ALLoc0:STRV?
// 3

SOURCE1:BB:EUTRa:DL:EMTC:NALLoc?
// 4
// MPDCCH allocation is the third allocation
// PBCH is always the first allocation
// if activated, PDSCH carrying SIB1-BR is the second one

// MPDCCH allocation
SOURCE1:BB:EUTRa:DL:EMTC:ALLoc2:CONType?
// MPD
SOURCE1:BB:EUTRa:DL:EMTC:ALLoc2:MODulation?
// QPSK
SOURCE1:BB:EUTRa:DL:EMTC:ALLoc2:STSFrame?
// 0
SOURCE1:BB:EUTRa:DL:EMTC:ALLoc2:ABSFrame?
// 4
SOURCE1:BB:EUTRa:DL:EMTC:ALLoc2:STNB?
// 1
SOURCE1:BB:EUTRa:DL:EMTC:ALLoc2:STSYmbol?
// 2
SOURCE1:BB:EUTRa:DL:EMTC:ALLoc2:PHYSbits?
// 436
SOURCE1:BB:EUTRa:DL:EMTC:ALLoc2:DATA?
// USER1
SOURCE1:BB:EUTRa:DL:EMTC:ALLoc2:POWer 0
SOURCE1:BB:EUTRa:DL:EMTC:ALLoc2:STAtE?
// 1
SOURCE1:BB:EUTRa:DL:EMTC:ALLoc2:CONFLICT?
// 0

// PDSCH allocation not carrying SIB-BR is the fourth allocation
SOURCE1:BB:EUTRa:DL:EMTC:ALLoc3:CONType?
// PDSC
SOURCE1:BB:EUTRa:DL:EMTC:ALLoc3:PHYSbits?
// 264
SOURCE1:BB:EUTRa:DL:EMTC:ALLoc3:DATA?
// USER1
SOURCE1:BB:EUTRa:DL:EMTC:ALLoc3:ABSFrame?
// 16
SOURCE1:BB:EUTRa:DL:EMTC:ALLoc3:STSFrame?
// 5
SOURCE1:BB:EUTRa:DL:EMTC:ALLoc3:NORB?
// 6
SOURCE1:BB:EUTRa:DL:EMTC:ALLoc3:OVRB?
// 0

```

```

SOURCE1:BB:EUTRa:DL:EMTC:ALLoc3:STSYmbol?
// 2
...
SOURCE1:BB:EUTRa:DL:EMTC:ALLoc3:POWer 0
SOURCE1:BB:EUTRa:DL:EMTC:ALLoc3:STATe?
// 1

SOURCE1:BB:EUTRa:DL:EMTC:ALLoc3:PRECoding:SCHEME?
// SPM
// because User 1 uses Tx mode TM6
SOURCE1:BB:EUTRa:DL:EMTC:ALLoc3:PRECoding:NOLayers?
// 1
SOURCE1:BB:EUTRa:DL:EMTC:ALLoc3:PRECoding:CCD NOCD
SOURCE1:BB:EUTRa:DL:EMTC:ALLoc3:PRECoding:CBINDEX 1
SOURCE1:BB:EUTRa:DL:EMTC:ALLoc3:SCRambling:STATe 1
SOURCE1:BB:EUTRa:DL:EMTC:ALLoc3:SCRambling:UEID?
// 10
SOURCE1:BB:EUTRa:DL:EMTC:ALLoc3:CCODing:STATe 1
SOURCE1:BB:EUTRa:DL:EMTC:ALLoc3:CCODing:TBSI?
// 5
SOURCE1:BB:EUTRa:DL:EMTC:ALLoc3:CCODing:TBSize?
// 72

```

Example: PBCH and SIB1-BR configuration

```

// PBCH scheduling and hopping
SOURCE1:BB:EUTRa:DL:EMTC:BMP:SIBBr 1
SOURCE1:BB:EUTRa:DL:EMTC:BMP:PBCHrep 1

SOURCE1:BB:EUTRa:DL:EMTC:DCI:NALLoc 1
SOURCE1:BB:EUTRa:DL:EMTC:DCI:ALLoc0:USER USER1
SOURCE1:BB:EUTRa:DL:EMTC:DCI:ALLoc0:UEID?
// 10
SOURCE1:BB:EUTRa:DL:EMTC:DCI:ALLoc0:FMT F61A
SOURCE1:BB:EUTRa:DL:EMTC:DCI:ALLoc0:SSP UE
SOURCE1:BB:EUTRa:DL:EMTC:DCI:ALLoc0:STSFrame 0
// first allowed subframe number is calculated automatically
SOURCE1:BB:EUTRa:DL:EMTC:DCI:ALLoc0:PDCCCh 2
SOURCE1:BB:EUTRa:DL:EMTC:DCI:ALLoc0:IDCCe 1
SOURCE1:BB:EUTRa:DL:EMTC:DCI:ALLoc0:CCES?
// 2

SOURCE1:BB:EUTRa:DL:EMTC:NALLoc?
// 4
// PBCH is always the first allocation
// if enabled, PDSCH carrying SIB1-BR is the second one

// PBCH allocation
SOURCE1:BB:EUTRa:DL:EMTC:ALLoc0:CONType?
// PBCH
SOURCE1:BB:EUTRa:DL:EMTC:ALLoc0:MODulation?
// QPSK

```

```

SOURCE1:BB:EUTRa:DL:EMTC:ALLoc0:STSFrame?
// 0
SOURCE1:BB:EUTRa:DL:EMTC:ALLoc0:STSYmbol?
// 2
SOURCE1:BB:EUTRa:DL:EMTC:ALLoc0:PHYSbits?
// 480
SOURCE1:BB:EUTRa:DL:EMTC:ALLoc0:DATA?
// MIB
SOURCE1:BB:EUTRa:DL:EMTC:ALLoc0:POWer 0
SOURCE1:BB:EUTRa:DL:EMTC:ALLoc0:STAtE?
// 1
SOURCE1:BB:EUTRa:DL:EMTC:ALLoc0:CONFLict?
// 0

// Transmission antennas and antenna port mapping
SOURCE1:BB:EUTRa:DL:MIMO:CONFIguration TX2
SOURCE1:BB:EUTRa:DL:MIMO:ANTenna ANT1

// Precoding for two Tx antennas
SOURCE1:BB:EUTRa:DL:EMTC:ALLoc0:PRECoding:SCHEME TXD
SOURCE1:BB:EUTRa:DL:EMTC:ALLoc0:PRECoding:NOLayers?
// 2
SOURCE1:BB:EUTRa:DL:EMTC:ALLoc0:SCRambling:STAtE 1
SOURCE1:BB:EUTRa:DL:EMTC:ALLoc0:SCRambling:UEID?
// 10

SOURCE1:BB:EUTRa:DL:EMTC:ALLoc0:CCODing:STAtE 1
SOURCE1:BB:EUTRa:DL:EMTC:ALLoc0:CCODing:MIB 1
SOURCE1:BB:EUTRa:DL:EMTC:ALLoc0:CCODing:SOFFset 60

SOURCE1:BB:EUTRa:DL:EMTC:ALLoc0:CCODing:SIB?
// 1
// resembles the value set with SOURCE1:BB:EUTRa:DL:EMTC:BMP:SIBBr
SOURCE1:BB:EUTRa:DL:EMTC:ALLoc0:CCODing:RSIB?
// 4
SOURCE1:BB:EUTRa:DL:EMTC:ALLoc0:CCODing:MSpare #H00,5
SOURCE1:BB:EUTRa:DL:EMTC:ALLoc0:CCODing:TBSIZE?

SOURCE1:BB:EUTRa:DL:EMTC:ALLoc1:CONType?
// PSIB
SOURCE1:BB:EUTRa:DL:EMTC:ALLoc1:MODulation?
// QPSK
SOURCE1:BB:EUTRa:DL:EMTC:ALLoc1:STSFrame?
// 0
SOURCE1:BB:EUTRa:DL:EMTC:ALLoc1:ABSFrame?
// 1
SOURCE1:BB:EUTRa:DL:EMTC:ALLoc1:STNB?
// 1
SOURCE1:BB:EUTRa:DL:EMTC:ALLoc1:STSYmbol?
// 3
SOURCE1:BB:EUTRa:DL:EMTC:ALLoc1:NORB?

```

```
// 6
SOURCE1:BB:EUTRa:DL:EMTC:ALLoc1:PHYSbits?
// 1510
SOURCE1:BB:EUTRa:DL:EMTC:ALLoc1:DATA?
// SIBB
SOURCE1:BB:EUTRa:DL:EMTC:ALLoc1:STATe?
// 1
SOURCE1:BB:EUTRa:DL:EMTC:ALLoc1:CONFLICT?
// 0
```

Example: DCI format 6-2 configuration

DCI format 6-2 carries paging and direct indication. If DCI format 6-2 is used, one MPDCCH is configured and activated automatically.

```
SOURCE1:BB:EUTRa:DL:EMTC:DCI:NALLoc 1
SOURCE1:BB:EUTRa:DL:EMTC:DCI:ALLoc0:USER PRNT
SOURCE1:BB:EUTRa:DL:EMTC:DCI:ALLoc0:UEID?
// 65534
SOURCE1:BB:EUTRa:DL:EMTC:DCI:ALLoc0:FMT?
// F62
SOURCE1:BB:EUTRa:DL:EMTC:DCI:ALLoc0:SSP?
// T1CM
SOURCE1:BB:EUTRa:DL:EMTC:DCI:ALLoc0:STSF 0
SOURCE1:BB:EUTRa:DL:EMTC:DCI:ALLoc0:PDCCCh?
// 5
SOURCE1:BB:EUTRa:DL:EMTC:DCI:ALLoc0:CCES?
// 10
SOURCE1:BB:EUTRa:DL:EMTC:DCI:ALLoc0:IDCCe?
// 0

// SOURCE1:BB:EUTRa:DL:EMTC:DCI:ALLoc0:PAGNg 0
// SOURCE1:BB:EUTRa:DL:EMTC:DCI:ALLoc0:DIINfo 100

SOURCE1:BB:EUTRa:DL:EMTC:DCI:ALLoc0:PAGNg 1
SOURCE1:BB:EUTRa:DL:EMTC:DCI:ALLoc0:RBA 3
SOURCE1:BB:EUTRa:DL:EMTC:DCI:ALLoc0:MCSScheme 3
SOURCE1:BB:EUTRa:DL:EMTC:DCI:ALLoc0:NREP 3
SOURCE1:BB:EUTRa:DL:EMTC:DCI:ALLoc0:BITS?
// "000 1100 0111"
```

Example: eMTC PUSCH configuration

```
SOURCE1:BB:EUTRa:STDMoDe IOT
SOURCE1:BB:EUTRa:LINK UP
SOURCE1:BB:EUTRa:UL:EMTC:VALid:SUBFrame1 1
SOURCE1:BB:EUTRa:UL:BW BW5_00
SOURCE1:BB:EUTRa:UL:EMTC:NNBands?
// 4
SOURCE1:BB:EUTRa:UL:UE1:RELease EMTC
SOURCE1:BB:EUTRa:UL:UE1:STATe 1
```



```

SOURCEl:BB:EUTRa:UL:UE1:MODE STD
SOURCEl:BB:EUTRa:UL:UE1:EMTC:TRANs1:REPetitions R4
SOURCEl:BB:EUTRa:UL:PUSCh:NHOPping 1
SOURCEl:BB:EUTRa:UL:PUSCh:NHOFFset 2

SOURCEl:BB:EUTRa:UL:UE1:EMTC:HOPP H4
SOURCEl:BB:EUTRa:UL:UE1:EMTC:CELevel CE01
SOURCEl:BB:EUTRa:UL:UE1:EMTC:NTRansmiss 1
SOURCEl:BB:EUTRa:UL:UE1:EMTC:TRANs1:CONTent PUSC
SOURCEl:BB:EUTRa:UL:UE1:EMTC:TRANs1:MODulation QPSK
SOURCEl:BB:EUTRa:UL:UE1:EMTC:TRANs1:STSFrame 61
SOURCEl:BB:EUTRa:UL:UE1:EMTC:TRANs1:REPetitions R16
SOURCEl:BB:EUTRa:UL:UE1:EMTC:TRANs1:STNBand 1
SOURCEl:BB:EUTRa:UL:UE1:EMTC:TRANs1:NRBLocks 5
SOURCEl:BB:EUTRa:UL:UE1:EMTC:TRANs1:RBOFFset 1
SOURCEl:BB:EUTRa:UL:UE1:EMTC:TRANs1:POW 0
SOURCEl:BB:EUTRa:UL:UE1:EMTC:TRANs1:ASFFrame?
// 16

SOURCEl:BB:EUTRa:UL:UE1:CELL0:PUSCh:DATA PN9
SOURCEl:BB:EUTRa:UL:UE1:CELL0:PUSCh:SCRambling:STATe 1
SOURCEl:BB:EUTRa:UL:UE1:CELL0:PUSCh:CCODing:STATe 1
SOURCEl:BB:EUTRa:UL:UE1:CELL0:PUSCh:CCODing:MODE COMB
SOURCEl:BB:EUTRa:UL:UE1:CELL0:PUSCh:CCODing:IHARqoffset 0
SOURCEl:BB:EUTRa:UL:UE1:CELL0:PUSCh:CCODing:ICQioffset 2
SOURCEl:BB:EUTRa:UL:UE1:EMTC:TRANs1:DRS:CYCShift?
// 0
SOURCEl:BB:EUTRa:UL:UE1:EMTC:TRANs1:NDMRs?
// 0
SOURCEl:BB:EUTRa:UL:UE1:EMTC:TRANs1:HARQ:MODE MUX
SOURCEl:BB:EUTRa:UL:UE1:EMTC:TRANs1:HARQ:BITS 2
SOURCEl:BB:EUTRa:UL:UE1:EMTC:TRANs1:HARQ:PATtern #H2,2
SOURCEl:BB:EUTRa:UL:UE1:EMTC:TRANs1:HARQ:CBITs?
// 144
SOURCEl:BB:EUTRa:UL:UE1:EMTC:TRANs1:PUSCh:CQI:BITS 12
SOURCEl:BB:EUTRa:UL:UE1:EMTC:TRANs1:PUSCh:CQI:PATtern #HC,4
SOURCEl:BB:EUTRa:UL:UE1:EMTC:TRANs1:PUSCh:CQI:CBITs?
// 810
SOURCEl:BB:EUTRa:UL:UE1:EMTC:TRANs1:CCODing:TBSize 16
SOURCEl:BB:EUTRa:UL:UE1:EMTC:TRANs1:CCODing:RVIndex 2
SOURCEl:BB:EUTRa:UL:UE1:EMTC:TRANs1:PHYSbits?
// 1440
SOURCEl:BB:EUTRa:UL:UE1:EMTC:TRANs1:ULSch:BITS?
// 584

SOURCEl:BB:EUTRa:UL:UE1:EMTC:ARB:SUGGested?
SOURCEl:BB:EUTRa:SLENgth 10
SOURCEl:BB:EUTRa:STATe 1

```

Example: eMTC PUCCH configuration

```

SOURCEl:BB:EUTRa:UL:PUCCh:NORB 4
SOURCEl:BB:EUTRa:UL:PUCCh:N1CS 1
SOURCEl:BB:EUTRa:UL:PUCCh:DESHift 1
SOURCEl:BB:EUTRa:UL:PUCCh:N2RB 0

SOURCEl:BB:EUTRa:UL:UE1:MODE STD
SOURCEl:BB:EUTRa:UL:UE1:EMTC:NTRansmiss 2
SOURCEl:BB:EUTRa:UL:UE1:EMTC:TRANs2:CONTent PUCCh
SOURCEl:BB:EUTRa:UL:UE1:EMTC:TRANs2:FORMat F2B
SOURCEl:BB:EUTRa:UL:UE1:EMTC:TRANs2:STSFrame 77
SOURCEl:BB:EUTRa:UL:UE1:EMTC:TRANs2:REPetitions R8
SOURCEl:BB:EUTRa:UL:UE1:EMTC:TRANs2:ASFFrame?
// 8
SOURCEl:BB:EUTRa:UL:UE1:EMTC:TRANs2:POWEr 0
SOURCEl:BB:EUTRa:UL:UE1:EMTC:TRANs2:NAFused?
// 1
SOURCEl:BB:EUTRa:UL:UE1:EMTC:TRANs2:NPUCCh 2
SOURCEl:BB:EUTRa:UL:UE1:EMTC:TRANs2:PUCCh:HARQ:PATtern #H3,2
SOURCEl:BB:EUTRa:UL:UE1:EMTC:TRANs2:PUCCh:CQI:BITS 2
SOURCEl:BB:EUTRa:UL:UE1:EMTC:TRANs2:PUCCh:CQI:PATtern #H1,1
SOURCEl:BB:EUTRa:UL:UE1:EMTC:TRANs2:PUCCh:CQI:CBITs?
// 20
SOURCEl:BB:EUTRa:SLENgth 10

```

Example: eMTC PRACH configuration

```

SOURCEl:BB:EUTRa:UL:PRACH:EMTC:HOFF 6
SOURCEl:BB:EUTRa:UL:PRACH:EMTC:RSET OFF
SOURCEl:BB:EUTRa:UL:PRACH:EMTC:CELV0:FOFFset 2
SOURCEl:BB:EUTRa:UL:PRACH:EMTC:CELV0:SSFPeriod 2
SOURCEl:BB:EUTRa:UL:PRACH:EMTC:CELV1:CONFig 48
SOURCEl:BB:EUTRa:UL:PRACH:EMTC:CELV1:FOFFset 16
SOURCEl:BB:EUTRa:UL:PRACH:EMTC:CELV1:HOPPing 1
SOURCEl:BB:EUTRa:UL:PRACH:EMTC:CELV1:REPetit R2
SOURCEl:BB:EUTRa:UL:PRACH:EMTC:CELV1:SSFPeriod NONE
SOURCEl:BB:EUTRa:UL:PRACH:EMTC:CELV2:CONFig 9
SOURCEl:BB:EUTRa:UL:PRACH:EMTC:CELV2:FOFFset 10
SOURCEl:BB:EUTRa:UL:PRACH:EMTC:CELV2:REPetit R8
SOURCEl:BB:EUTRa:UL:PRACH:EMTC:CELV2:SSFPeriod NONE
SOURCEl:BB:EUTRa:UL:PRACH:EMTC:CELV3:CONFig 22
SOURCEl:BB:EUTRa:UL:PRACH:EMTC:CELV3:FOFFset 6
SOURCEl:BB:EUTRa:UL:PRACH:EMTC:CELV3:HOPPing 1
SOURCEl:BB:EUTRa:UL:PRACH:EMTC:CELV3:REPetit R4
SOURCEl:BB:EUTRa:UL:PRACH:EMTC:CELV3:SSFPeriod NONE

SOURCEl:BB:EUTRa:UL:UE2:STATe 1
SOURCEl:BB:EUTRa:UL:UE2:RELease EMTC
SOURCEl:BB:EUTRa:UL:UE2:MODE PRAC
SOURCEl:BB:EUTRa:UL:UE2:PRACH:EMTC:PRATtempts 4

```

```

SOURCE1:BB:EUTRa:UL:UE2:PRCh:ATT0:EMTC:SFStart 21
SOURCE1:BB:EUTRa:UL:UE2:PRCh:ATT0:EMTC:NCSCConf 0
SOURCE1:BB:EUTRa:UL:UE2:PRCh:ATT0:EMTC:RSEquence 10
SOURCE1:BB:EUTRa:UL:UE2:PRCh:ATT0:EMTC:SINdex 12
SOURCE1:BB:EUTRa:UL:UE2:PRCh:ATT0:EMTC:DT 0
SOURCE1:BB:EUTRa:UL:UE2:PRCh:ATT0:EMTC:POWer 0
SOURCE1:BB:EUTRa:UL:UE2:PRCh:ATT1:EMTC:CELV 1
SOURCE1:BB:EUTRa:UL:UE2:PRCh:ATT1:EMTC:SFStart 41
SOURCE1:BB:EUTRa:UL:UE2:PRCh:ATT2:EMTC:CELV 2
SOURCE1:BB:EUTRa:UL:UE2:PRCh:ATT2:EMTC:SFStart 81
SOURCE1:BB:EUTRa:UL:UE2:PRCh:ATT3:EMTC:CELV 3
SOURCE1:BB:EUTRa:UL:UE2:PRCh:ATT3:EMTC:SFStart 121

SOURCE1:BB:EUTRa:UL:UE2:PRCh:EMTC:ARB:SUGGested?
SOURCE1:BB:EUTRa:SLENgth 14

```

10.27.1 General IoT downlink

- [Physical settings](#)..... 823
- [DL reference and synchronization signals](#)..... 824
- [NPRS](#)..... 825
- [NB-IoT wake-up signal](#)..... 829
- [NB-IoT carrier allocation](#)..... 831
- [eMTC bitmap, valid subframes, hopping and common search space](#)..... 838

10.27.1.1 Physical settings

[:SOURCE<hw>]:BB:EUTRa:DL:EMTC:NNBands?

Queries the number of narrowbands.

Return values:

```

<NumNarrowbands> integer
                    Range:    0 to 18
                    *RST:     1

```

Example: SOURCE1:BB:EUTRa:DL:EMTC:NNBands?

Usage: Query only

Manual operation: See "[Number of eMTC Narrowbands](#)" on page 94

[:SOURCE<hw>]:BB:EUTRa:DL:EMTC:WBCFg <WideBandCfg>

If enabled, the available channel bandwidth is split into eMTC widebands with the selected bandwidth.

Parameters:

```

<WideBandCfg>    OFF | BW5_00 | BW20_00
                    *RST:    OFF

```

- Example:** See [Example"eMTC widebands configuration"](#) on page 814.
- Options:** R&S SMM-K143
- Manual operation:** See ["Wideband Config"](#) on page 95

[:SOURce<hw>]:BB:EUTRa:DL:EMTC:NWBands?

Queries the number of widebands.

Return values:

<NumWideBands> integer
 Range: 0 to 4
 *RST: 1

- Example:** See [Example"eMTC widebands configuration"](#) on page 814.
- Usage:** Query only
- Options:** R&S SMM-K143
- Manual operation:** See ["Number of eMTC Widebands"](#) on page 95

10.27.1.2 DL reference and synchronization signals

[:SOURce<hw>]:BB:EUTRa:DL:REFSig:NIOT:POWer.....	824
[:SOURce<hw>]:BB:EUTRa:DL:SYNC:NIOT:TXANtenna.....	824
[:SOURce<hw>]:BB:EUTRa:DL:SYNC:NIOT:NPPWr.....	825
[:SOURce<hw>]:BB:EUTRa:DL:SYNC:NIOT:NSPW.....	825

[:SOURce<hw>]:BB:EUTRa:DL:REFSig:NIOT:POWer <NbRefSigSymPowe>

Sets the power of the narrowband reference signal (NRS).

Parameters:

<NbRefSigSymPowe>float
 Range: -80 to 10
 Increment: 0.01
 *RST: 0

- Example:** See [Example"NB-IoT anchor carrier in standalone mode"](#) on page 799.
- Manual operation:** See ["Narrowband Reference Signal Power"](#) on page 104

[:SOURce<hw>]:BB:EUTRa:DL:SYNC:NIOT:TXANtenna <NpNsSyncTxAnt>

Defines on which antenna the NPSS/NSSS are transmitted.

Parameters:

<NpNsSyncTxAnt> NONE | ANT1 | ANT2 | ALL
 *RST: ALL

Example: See [Example "NB-IoT anchor carrier in standalone mode"](#) on page 799.

Manual operation: See ["NP-/NS-Sync Tx Antenna"](#) on page 104

```
[ :SOURce<hw>]:BB:EUTRa:DL:SYNC:NIOT:NPPW<NPSyncPower>
[:SOURce<hw>]:BB:EUTRa:DL:SYNC:NIOT:NSPW<NsSyncPower>
```

Sets the power of the NPSS/NSSS allocations.

Parameters:

```
<NsSyncPower> float
Range: -80 to 10
Increment: 0.001
*RST: 0
```

Example: See [Example "NB-IoT anchor carrier in standalone mode"](#) on page 799.

Manual operation: See ["NP-SYNC Power/NS-SYNC Power"](#) on page 104

10.27.1.3 NPRS

Option: R&S SMM-K143

[:SOURce<hw>]:BB:EUTRa:DL:NIOT:NPRS:STATE.....	825
[:SOURce<hw>]:BB:EUTRa:DL:NIOT:NPRS:CONF.....	826
[:SOURce<hw>]:BB:EUTRa:DL:NIOT:NPRS:POW.....	826
[:SOURce<hw>]:BB:EUTRa:DL:NIOT:NPRS:ID.....	826
[:SOURce<hw>]:BB:EUTRa:DL:NIOT:NPRS:SEIN.....	826
[:SOURce<hw>]:BB:EUTRa:DL:NIOT:NPRS:BMP:CONF.....	827
[:SOURce<hw>]:BB:EUTRa:DL:NIOT:NPRS:BMP:VALSubframes<ch>.....	827
[:SOURce<hw>]:BB:EUTRa:DL:NIOT:NPRS:MTIA.....	827
[:SOURce<hw>]:BB:EUTRa:DL:NIOT:NPRS:MTIB.....	827
[:SOURce<hw>]:BB:EUTRa:DL:NIOT:NPRS:PERiod.....	828
[:SOURce<hw>]:BB:EUTRa:DL:NIOT:NPRS:STSFrame.....	828
[:SOURce<hw>]:BB:EUTRa:DL:NIOT:NPRS:SFNM.....	828

```
[ :SOURce<hw>]:BB:EUTRa:DL:NIOT:NPRS:STATE <NprsState>
```

Enables the NPRS transmission.

Parameters:

```
<NprsState> 1 | ON | 0 | OFF
*RST: 0
```

Example: See [Example "NPRS part A+B configuration in in-band mode"](#) on page 801.

Manual operation: See ["NPRS State"](#) on page 121

[:SOURce<hw>]:BB:EUTRa:DL:NIOT:NPRS:CONF <NprsParaCfg>

Defines which type of NPRS is used.

Parameters:

<NprsParaCfg> PA_A | PA_B | PA_AB
*RST: PA_A

Example: See [Example "NPRS part A+B configuration in in-band mode"](#) on page 801.

Manual operation: See ["NPRS Parameter"](#) on page 121

[:SOURce<hw>]:BB:EUTRa:DL:NIOT:NPRS:POW <NprsPower>

Sets the power of the narrowband positioning reference signal (NPRS).

Parameters:

<NprsPower> float
Range: -80 to 10
Increment: 0.001
*RST: 0

Example: See [Example "NPRS part A+B configuration in in-band mode"](#) on page 801.

Manual operation: See ["NPRS Power"](#) on page 122

[:SOURce<hw>]:BB:EUTRa:DL:NIOT:NPRS:ID <NprsId>

Sets the NPRS-ID used for the generation of the NPRS.

Parameters:

<NprsId> Integer
Range: 0 to 4095
Increment: 1
*RST: 0

Example: See [Example "NPRS part A+B configuration in in-band mode"](#) on page 801.

Manual operation: See ["NPRS ID"](#) on page 122

[:SOURce<hw>]:BB:EUTRa:DL:NIOT:NPRS:SEIN <NprsSeqInfo>

Specifies the index of the physical resource block (PRB) containing the NPRS.

Parameters:

<NprsSeqInfo> integer
Range: 0 to 174
*RST: 0

Example: See [Example "NPRS part A+B configuration in in-band mode"](#) on page 801.

Manual operation: See ["NPRS Sequence Information"](#) on page 122

[:SOURCE<hw>]:BB:EUTRa:DL:NIOT:NPRS:BMP:CONF <NprsBmp>

Sets if the NPRS subframe Part A configuration lasts 10 ms or 40 ms.

Parameters:

<NprsBmp> 10 | 40
*RST: 10

Example: See [Example "NPRS part A+B configuration in in-band mode"](#) on page 801.

Manual operation: See ["NPRS Bitmap"](#) on page 122

**[:SOURCE<hw>]:BB:EUTRa:DL:NIOT:NPRS:BMP:VALSubframes<ch>
<NprsBmpValidSf>**

Sets a subframe as valid and used for NPRS transmission.

Suffix:

<dir> 0 to 9
Subframe number

Parameters:

<NprsBmpValidSf> 1 | ON | 0 | OFF
*RST: 0

Example: See [Example "NPRS part A+B configuration in in-band mode"](#) on page 801.

Manual operation: See ["NPRS Bitmap Config"](#) on page 122

**[:SOURCE<hw>]:BB:EUTRa:DL:NIOT:NPRS:MTIA <NprsMutingInfoA>, <BitCount>
[:SOURCE<hw>]:BB:EUTRa:DL:NIOT:NPRS:MTIB <NprsMutingInfoB>, <BitCount>**

Sets the `nprs-MutingInfoA/nprs-MutingInfoB` parameter, required if muting is used for the NPRS part A (and Part B) configurations.

Parameters:

<NprsMutingInfoB> numeric
"1" indicates that the NPRS is transmitted in the corresponding occasion; a "0" indicates a muted NPRS.
*RST: #H3

<BitCount> integer

Sets the length of the periodically repeating NPRS bit sequence in number of NPRS position occurrences.
Allowed are the following values: 2, 4, 8 or 16

Range: 2 to 16
*RST: 2

Example: See [Example "NPRS part A+B configuration in in-band mode"](#) on page 801.

Manual operation: See ["NPRS Muting Information A/B"](#) on page 123

[:SOURce<hw>]:BB:EUTRa:DL:NIOT:NPRS:PERiod <NprsPeriod>

For NPRS Part B configuration, sets the NPRS occasion period T_{NPRS} .

Parameters:

<NprsPeriod> PD_160 | PD_320 | PD_640 | PD_1280
*RST: PD_160

Example: See [Example "NPRS part A+B configuration in in-band mode"](#) on page 801.

Manual operation: See ["NPRS Period"](#) on page 123

[:SOURce<hw>]:BB:EUTRa:DL:NIOT:NPRS:STSFframe <NprsStartSf>

For NPRS Part B configuration, sets the subframe offset a_{NPRS} .

Parameters:

<NprsStartSf> STSF0_8 | STSF1_8 | STSF2_8 | STSF3_8 | STSF4_8 |
STSF5_8 | STSF6_8 | STSF7_8
*RST: STSF0_8

Example: See [Example "NPRS part A+B configuration in in-band mode"](#) on page 801.

Manual operation: See ["NPRS Start Subframe"](#) on page 123

[:SOURce<hw>]:BB:EUTRa:DL:NIOT:NPRS:SFNM <NprsSfNumber>

For NPRS Part B configuration, sets the number of consecutive DL subframes N_{NPRS} within one NPRS positioning occasion.

Parameters:

<NprsSfNumber> SFNM_10 | SFNM_20 | SFNM_40 | SFNM_80 | SFNM_160 |
SFNM_320 | SFNM_640 | SFNM_1280
*RST: SFNM_10

Example: See [Example "NPRS part A+B configuration in in-band mode"](#) on page 801.

Manual operation: See ["NPRS Number of Subframes"](#) on page 123

10.27.1.4 NB-LoT wake-up signal

Option: R&S SMM-K146

[:SOURce<hw>]:BB:EUTRa:DL:NIOT:WUS:ACD	829
[:SOURce<hw>]:BB:EUTRa:DL:NIOT:WUS:MAXDuration	829
[:SOURce<hw>]:BB:EUTRa:DL:NIOT:WUS:POW	829
[:SOURce<hw>]:BB:EUTRa:DL:NIOT:WUS:PSF?	830
[:SOURce<hw>]:BB:EUTRa:DL:NIOT:WUS:SF	830
[:SOURce<hw>]:BB:EUTRa:DL:NIOT:WUS:STATe	830
[:SOURce<hw>]:BB:EUTRa:DL:NIOT:WUS:TO	831

[\[:SOURce<hw>\]:BB:EUTRa:DL:NIOT:WUS:ACD](#) <NwusActD>

Sets the duration of WUS in subframes.

Parameters:

<NwusActD> DN_1 | DN_2 | DN_4 | DN_8 | DN_16 | DN_32 | DN_64 |
 DN_128 | DN_256 | DN_512 | DN_1024
 *RST: DN_1

Example: See [Example"NB-LoT wake up signal"](#) on page 801

Options: R&S SMM-K146

Manual operation: See ["NWUS Actual Duration"](#) on page 125

[\[:SOURce<hw>\]:BB:EUTRa:DL:NIOT:WUS:MAXDuration](#) <NwusMaxDur>

Sets the maximum WUS duration in subframes.

Parameters:

<NwusMaxDur> DN_1 | DN_2 | DN_4 | DN_8 | DN_16 | DN_32 | DN_64 |
 DN_128 | DN_256 | DN_512 | DN_1024
 *RST: DN_1

Example: See [Example"NB-LoT wake up signal"](#) on page 801

Options: R&S SMM-K146

Manual operation: See ["NWUS Max Duration"](#) on page 124

[\[:SOURce<hw>\]:BB:EUTRa:DL:NIOT:WUS:POW](#) <NwusPower>

Sets the transmit power of NB-LoT wake up signal

Parameters:

<NwusPower> float
 Range: -80 to 10
 Increment: 0.001
 *RST: 0
 Default unit: dB

Example: See [Example "NB-LoT wake up signal"](#) on page 801

Options: R&S SMM-K146

Manual operation: See ["NWUS Power"](#) on page 124

[[:SOURce<hw>]:BB:EUTRa:DL:NIOT:WUS:PSF?

Queries the first paging occasion in subframes associated with WUS.

Return values:

<NwusPSF> integer
 Range: 0 to 534593
 *RST: 40

Example: See [Example "NB-LoT wake up signal"](#) on page 801

Usage: Query only

Options: R&S SMM-K146

Manual operation: See ["Paging Start Subframe"](#) on page 125

[[:SOURce<hw>]:BB:EUTRa:DL:NIOT:WUS:SF <NwusSF>

Specifies the first subframe for paging associated with a WUS transmission.

Parameters:

<NwusSF> Integer
 Range: 0 to 533329
 Increment: 1
 *RST: 0

Example: See [Example "NB-LoT wake up signal"](#) on page 801

Options: R&S SMM-K146

Manual operation: See ["NWUS Start Subframe"](#) on page 124

[[:SOURce<hw>]:BB:EUTRa:DL:NIOT:WUS:STATE <NwusState>

Enables or disables the NB-LoT wake up signal.

Parameters:

<NwusState> 1 | ON | 0 | OFF
 *RST: 0

- Example:** See [Example "NB-LoT wake up signal"](#) on page 801
- Options:** R&S SMM-K146
- Manual operation:** See ["NWUS State"](#) on page 124

[:SOURce<hw>]:BB:EUTRa:DL:NIOT:WUS:TO <NwusTO>

Sets the offset in ms from the end of the configured maximum WUS duration to the associated paging occasion.

Parameters:

<NwusTO> TO_40 | TO_80 | TO160 | TO240
 *RST: TO_40

- Example:** See [Example "NB-LoT wake up signal"](#) on page 801
- Options:** R&S SMM-K146
- Manual operation:** See ["NWUS Time Offset"](#) on page 125

10.27.1.5 NB-LoT carrier allocation

[:SOURce<hw>]:BB:EUTRa:DL:MIMO:NIOT:CONFig	831
[:SOURce<hw>]:BB:EUTRa:DL:NIOT:PUNcTure	832
[:SOURce<hw>]:BB:EUTRa:DL:NIOT:LTECell:STATe	832
[:SOURce<hw>]:BB:EUTRa:DL:NIOT:GAP:CONFig:STATe	832
[:SOURce<hw>]:BB:EUTRa:DL:NIOT:GAP:THReshold	833
[:SOURce<hw>]:BB:EUTRa:DL:NIOT:GAP:PERiodicity	833
[:SOURce<hw>]:BB:EUTRa:DL:NIOT:GAP:DURation:COEFficient	833
[:SOURce<hw>]:BB:EUTRa:DL:CARRier<ch>:NIOT:MODE	833
[:SOURce<hw>]:BB:EUTRa:DL:CARRier<ch>:NIOT:RBIDx	834
[:SOURce<hw>]:BB:EUTRa:DL:CARRier<ch>:NIOT:DFReq	834
[:SOURce<hw>]:BB:EUTRa:DL:CARRier<ch>:NIOT:CRSSeq	834
[:SOURce<hw>]:BB:EUTRa:DL:CARRier<ch>:NIOT:CELL	834
[:SOURce<hw>]:BB:EUTRa:DL:CARRier<ch>:NIOT:CIDGroup	835
[:SOURce<hw>]:BB:EUTRa:DL:NIOT:ID?	835
[:SOURce<hw>]:BB:EUTRa:DL:CARRier<ch>:NIOT:NVSF	835
[:SOURce<hw>]:BB:EUTRa:DL:CARRier<ch>:NIOT:GBRBidx	835
[:SOURce<hw>]:BB:EUTRa:DL:CARRier<ch>:NIOT:SFALI	836
[:SOURce<hw>]:BB:EUTRa:DL:CARRier<ch>:NIOT:SFNN	836
[:SOURce<hw>]:BB:EUTRa:DL:CARRier<ch>:NIOT:SF<st0>:VALSf	836
[:SOURce<hw>]:BB:EUTRa:DL:NIOT:PAG:RMAX	837
[:SOURce<hw>]:BB:EUTRa:DL:NIOT:RAND:RMAX	837
[:SOURce<hw>]:BB:EUTRa:DL:NIOT:RAND:SSOFFset	837
[:SOURce<hw>]:BB:EUTRa:DL:NIOT:RAND:STSFrame	837
[:SOURce<hw>]:BB:EUTRa:DL:CARRier<ch>:NIOT:STATe	838

[:SOURce<hw>]:BB:EUTRa:DL:MIMO:NIOT:CONFig <NbiotMimoConf>

Set the number of transmit antennas used for the simulated NB-LoT system.

Parameters:

<NbiotMimoConf> TX2 | TX1
 *RST: TX1

Example: See [Example "NB-IoT anchor carrier in standalone mode"](#) on page 799.

Manual operation: See ["NB-IoT MIMO Configuration"](#) on page 126

[:SOURCE<hw>]:BB:EUTRa:DL:NIOT:PUNCTure <PunctureInband>

Punctures the LTE signal at the NB-IoT in-band or guard band carriers.

Parameters:

<PunctureInband> 1 | ON | 0 | OFF
 *RST: 0

Example:

```
SOURcel:BB:EUTRa:DUPLexing FDD
SOURcel:BB:EUTRa:LINK DOWN
SOURcel:BB:EUTRa:STDMoDe LIOT
SOURcel:BB:EUTRa:DL:BW BW5_00
SOURcel:BB:EUTRa:DL:CARRier1:NIOT:STATe 1
SOURcel:BB:EUTRa:DL:CARRier1:NIOT:MoDE INBD
SOURcel:BB:EUTRa:DL:NIOT:PUNCTure 1
```

Manual operation: See ["Puncture LTE at Inband Carriers"](#) on page 371

[:SOURCE<hw>]:BB:EUTRa:DL:NIOT:LTECell:STATe <LTECell>

In in-band mode, defines how the LTE channels are handled.

If enabled, all LTE channels are deactivated. However, LTE reference signals are still transmitted.

Parameters:

<LTECell> 1 | ON | 0 | OFF
 *RST: 1

Example: See [Example "NB-IoT carriers in in-band mode"](#) on page 800.

Manual operation: See ["LTE Cell"](#) on page 370

[:SOURCE<hw>]:BB:EUTRa:DL:NIOT:GAP:CONFig:STATe <GapConfig>

If activated, a gap between the NPDCCH and NPDSCH with the specified duration is applied.

Parameters:

<GapConfig> 1 | ON | 0 | OFF
 *RST: 1

Example: See [Example "NB-IoT carriers in in-band mode"](#) on page 800.

Manual operation: See ["Gap Configuration"](#) on page 370

[:SOURCE<hw>]:BB:EUTRa:DL:NIOT:GAP:THReshold <GapThreshold>

Sets the gap threshold.

Parameters:

<GapThreshold> 32 | 64 | 128 | 256
*RST: 32

Example: See [Example"NB-IoT carriers in in-band mode"](#) on page 800.

Manual operation: See ["Gap Threshold"](#) on page 370

[:SOURCE<hw>]:BB:EUTRa:DL:NIOT:GAP:PERiodicity <GapPeriodicity>

Sets the number of subframes after that the configured gap is repeated.

Parameters:

<GapPeriodicity> 64 | 128 | 256 | 512
*RST: 64

Example: See [Example"NB-IoT carriers in in-band mode"](#) on page 800.

Manual operation: See ["Gap Periodicity"](#) on page 371

[:SOURCE<hw>]:BB:EUTRa:DL:NIOT:GAP:DURation:COEFFicent <GapDurCoeff>

Sets the gap duration coefficient.

Parameters:

<GapDurCoeff> 1_8 | 1_4 | 3_8 | 1_2
*RST: 1_8

Example: See [Example"NB-IoT carriers in in-band mode"](#) on page 800.

Manual operation: See ["Gap Duration Coefficient"](#) on page 371

[:SOURCE<hw>]:BB:EUTRa:DL:CARRier<ch>:NIOT:MODE <Mode>

Sets the operating mode.

Parameters:

<Mode> INBD | ALON | GBD
*RST: INBD

Example: See [Example"NB-IoT anchor carrier in standalone mode"](#) on page 799.

Manual operation: See ["Mode"](#) on page 371

[:SOURce<hw>]:BB:EUTRa:DL:CARRier<ch>:NIOT:RBIDx <RblIndex>

Sets the resource block number in that the NB-LoT transmissions are allocated.

Parameters:

<RblIndex> 2 | 4 | 7 | 9 | 12 | 14 | 17 | 19 | 22 | 27 | 24 | 29 | 30 | 32 | 34 | 35 |
 39 | 42 | 44 | 40 | 45 | 47 | 52 | 55 | 57 | 60 | 62 | 65 | 67 | 70 |
 72 | 75 | 80 | 85 | 90 | 95 | USER
 *RST: 40

Example: See [Example"NB-LoT anchor carrier in standalone mode"](#)
 on page 799.

Manual operation: See ["RB Index"](#) on page 372

[:SOURce<hw>]:BB:EUTRa:DL:CARRier<ch>:NIOT:DFReq <DeltaFreq>

Sets the frequency offset between the NB-LoT carrier and the LTE center frequency.

Parameters:

<DeltaFreq> float
 Range: -10000000 to 10000000
 *RST: 0
 Default unit: MHz

Example: See [Example"NB-LoT carriers in in-band mode"](#) on page 800.

Manual operation: See ["Delta Frequency to DC, MHz"](#) on page 373

[:SOURce<hw>]:BB:EUTRa:DL:CARRier<ch>:NIOT:CRSSeq <CrsSeqInfo>

Sets the CRS sequence info.

Parameters:

<CrsSeqInfo> 0 | 1 | 2 | 3 | 4 | 5 | 6 | 7 | 8 | 9 | 10 | 11 | 12 | 13 | 14 | 15 | 16 |
 17 | 18 | 19 | 20 | 21 | 22 | 23 | 24 | 25 | 26 | 27 | 28 | 29 | 30 | 31

Example: See [Example"NB-LoT carriers in in-band mode"](#) on page 800.

Manual operation: See ["CRS Sequence Info"](#) on page 372

[:SOURce<hw>]:BB:EUTRa:DL:CARRier<ch>:NIOT:CELL <CellID>

Sets the narrowband physical cell identifier.

Parameters:

<CellID> integer
 Range: 0 to 503
 *RST: 0

Example: See [Example"NB-LoT carriers in in-band mode"](#) on page 800.

Manual operation: See ["NCell ID"](#) on page 373

[:SOURce<hw>]:BB:EUTRa:DL:CARRier<ch>:NIOT:CIDGroup <CellIdGr>

Queries the physical cell identity group.

Parameters:

<CellIdGr> integer
 Range: 0 to 111
 *RST: 0

Example: See [Example "NB-IoT carriers in in-band mode"](#) on page 800.

Manual operation: See ["NCell ID Group"](#) on page 373

[:SOURce<hw>]:BB:EUTRa:DL:NIOT:ID?

Queries the physical layer identity.

Return values:

<Identity> integer
 Range: 0 to 111
 *RST: 0

Example: See [Example "NB-IoT carriers in in-band mode"](#) on page 800.

Usage: Query only

Manual operation: See ["Identity"](#) on page 373

[:SOURce<hw>]:BB:EUTRa:DL:CARRier<ch>:NIOT:NVSF <NoValidSubframe>

Sets the subframes bitmap.

Parameters:

<NoValidSubframe> N10 | N40
 *RST: N10

Example: See [Example "NB-IoT anchor carrier in standalone mode"](#) on page 799.

Manual operation: See ["Valid Subframes"](#) on page 374
 See ["Bitmap Subframes"](#) on page 375

[:SOURce<hw>]:BB:EUTRa:DL:CARRier<ch>:NIOT:GBRBidx <RbIndexGB>

In guardband operation, sets the resource block number in that the NB-IoT transmissions are allocated.

Parameters:

<RbIndexGB> integer

Example:

```
SOURce1:BB:EUTRa:DL:BW BW5_00
SOURce1:BB:EUTRa:DL:CARRier1:NIOT:MODE GBD
SOURce1:BB:EUTRa:DL:CARRier1:NIOT:GBRBidx 26
```

Manual operation: See ["RB Index"](#) on page 372

[:SOURce<hw>]:BB:EUTRa:DL:CARRier<ch>:NIOT:SFALI

Sets all SFs to valid.

Example: See [Example "NB-IoT anchor carrier in standalone mode"](#) on page 799.

Usage: Event

Manual operation: See ["Select All/Deselect All"](#) on page 375

[:SOURce<hw>]:BB:EUTRa:DL:CARRier<ch>:NIOT:SFNN

Sets all SFs to invalid.

Example:

```
SOURce1:BB:EUTRa:DL:CARRier2:NIOT:SFNN
SOURce1:BB:EUTRa:DL:CARRier2:NIOT:SF1:VALSf?
// 0
```

Usage: Event

Manual operation: See ["Select All/Deselect All"](#) on page 375

[:SOURce<hw>]:BB:EUTRa:DL:CARRier<ch>:NIOT:SF<st0>:VALSf <Valid>

Sets the valid subframes.

Suffix:

<st0> 0 to 9/ 0 to 39
Subframe number, where the max number of subframes depends on the selected bitmap

```
[ :SOURce<hw>]:BB:EUTRa:DL:CARRier<ch>:NIOT:NVSF
N10: 0 to 9
[ :SOURce<hw>]:BB:EUTRa:DL:CARRier<ch>:NIOT:NVSF
N40: 0 to 39
```

Parameters:

<Valid> 1 | ON | 0 | OFF

1
Valid subframe

0
Not valid subframe

*RST: 1

Example: See [Example "NB-IoT anchor carrier in standalone mode"](#) on page 799.

Manual operation: See ["Valid Subframes"](#) on page 374

[[:SOURce<hw>]:BB:EUTRa:DL:NIOT:PAG:RMAX <PagingRmax>

Sets the maximum number NPDCCH is repeated R_{Max} (paging).

Parameters:

<PagingRmax> R1 | R2 | R4 | R8 | R16 | R32 | R64 | R128 | R256 | R512 |
R1024 | R2048
*RST: R1

Example: See [Example "NB-LoT anchor carrier in standalone mode"](#) on page 799.

Manual operation: See ["Max. Repetitions of NPDCCH \(Rmax\) for Type 1 common search space"](#) on page 378

[[:SOURce<hw>]:BB:EUTRa:DL:NIOT:RAND:RMAX <RandomRmax>

Sets the maximum number NPDCCH is repeated R_{Max} (random access).

Parameters:

<RandomRmax> R1 | R2 | R4 | R8 | R16 | R32 | R64 | R128 | R256 | R512 |
R1024 | R2048
*RST: R1

Example: See [Example "NB-LoT anchor carrier in standalone mode"](#) on page 799.

Manual operation: See ["Max. Repetitions of NPDCCH \(Rmax\) for Type 2 common search space"](#) on page 378

[[:SOURce<hw>]:BB:EUTRa:DL:NIOT:RAND:SSOOffset <RandomOffset>

Sets the search space offset (α_{offset}).

Parameters:

<RandomOffset> O0 | O1_8 | O1_4 | O3_8
*RST: O0

Example: See [Example "NB-LoT anchor carrier in standalone mode"](#) on page 799.

Manual operation: See ["Search Space Offset \(\$\alpha_{offset}\$ \)"](#) on page 379

[[:SOURce<hw>]:BB:EUTRa:DL:NIOT:RAND:STSFrame <StartSf>

Sets the start SF for the random access common search space.

Parameters:

<StartSf> S1_5 | S2 | S4 | S8 | S16 | S32 | S48 | S64
*RST: S4

Example: See [Example "NB-LoT anchor carrier in standalone mode"](#) on page 799.

Manual operation: See ["Search Space Start Subframe \(G\)"](#) on page 379

[:SOURce<hw>]:BB:EUTRa:DL:CARRier<ch>:NIOT:STATe <State>

Enables the selected NB-LoT carrier.

To enable the NB-LoT configuration, enable the anchor carrier
(SOURce1:BB:EUTRa:DL:CARRier0:NIOT:STATe 1)

Parameters:

<State> 1 | ON | 0 | OFF
*RST: 0

Example: See [Example "NB-LoT anchor carrier in standalone mode"](#) on page 799.

Manual operation: See ["Activate NB-LoT"](#) on page 370
See ["State"](#) on page 375

10.27.1.6 eMTC bitmap, valid subframes, hopping and common search space

[:SOURce<hw>]:BB:EUTRa:DL:EMTC:BMP:SUBFrames	838
[:SOURce<hw>]:BB:EUTRa:DL:EMTC:BMP:START	839
[:SOURce<hw>]:BB:EUTRa:DL:EMTC:BMP:SIBBr	839
[:SOURce<hw>]:BB:EUTRa:DL:EMTC:BMP:PBCHrep	839
[:SOURce<hw>]:BB:EUTRa:DL:EMTC:BMP:SElectall DESelectall	839
[:SOURce<hw>]:BB:EUTRa:DL:EMTC:BMP:VALSubframes<ch>	840
[:SOURce<hw>]:BB:EUTRa:DL:EMTC:NB:NNBands?	840
[:SOURce<hw>]:BB:EUTRa:DL:EMTC:NB:HOPping	840
[:SOURce<hw>]:BB:EUTRa:DL:EMTC:NB:HOFfset	840
[:SOURce<hw>]:BB:EUTRa:DL:EMTC:NB:IVLA	841
[:SOURce<hw>]:BB:EUTRa:DL:EMTC:NB:IVLB	841
[:SOURce<hw>]:BB:EUTRa:DL:EMTC:NB:PHOPping	841
[:SOURce<hw>]:BB:EUTRa:DL:EMTC:NB:RHOPping	841
[:SOURce<hw>]:BB:EUTRa:DL:EMTC:NB:PSTNb	841
[:SOURce<hw>]:BB:EUTRa:DL:EMTC:NB:RSTNb	841
[:SOURce<hw>]:BB:EUTRa:DL:EMTC:SSP:MPD1	842
[:SOURce<hw>]:BB:EUTRa:DL:EMTC:SSP:MPD2	842
[:SOURce<hw>]:BB:EUTRa:DL:EMTC:SSP:STSF	842
[:SOURce<hw>]:BB:EUTRa:DL:EMTC:SSP:PDSA	842
[:SOURce<hw>]:BB:EUTRa:DL:EMTC:SSP:PDSB	842

[:SOURce<hw>]:BB:EUTRa:DL:EMTC:BMP:SUBFrames <BitmapSubframes>

Sets the valid subframes configuration over 10ms or 40ms.

Parameters:

<BitmapSubframes> 10 | 40
*RST: 10

Example: See [Example"eMTC valid subframes and hopping configuration"](#) on page 813.

Manual operation: See ["Bitmap Subframes"](#) on page 429

[[:SOURCE<hw>]:BB:EUTRa:DL:EMTC:BMP:START <StartingSymbol>

Defines the first symbol within a frame that can be used for eMTC.

Parameters:

<StartingSymbol> 1 | 2 | 3 | 4
*RST: 2

Example: See [Example"eMTC valid subframes and hopping configuration"](#) on page 813.

Manual operation: See ["Starting Symbol"](#) on page 429

[[:SOURCE<hw>]:BB:EUTRa:DL:EMTC:BMP:SIBBr <SchedInfoSIB1BR>

Sets the number of times the PDSCH allocation carrying the SIB1-BR is repeated.

Parameters:

<SchedInfoSIB1BR> integer
Range: 0 to 18
*RST: 0

Example: See [Example"eMTC valid subframes and hopping configuration"](#) on page 813.

Manual operation: See ["Scheduling Info SIB1-BR"](#) on page 429

[[:SOURCE<hw>]:BB:EUTRa:DL:EMTC:BMP:PBCHrep <PbchRepetitions>

Configures the cell for PBCH repetition.

Parameters:

<PbchRepetitions> 1 | ON | 0 | OFF
*RST: 1

Example: See [Example"eMTC valid subframes and hopping configuration"](#) on page 813.

Manual operation: See ["PBCH Repetition"](#) on page 430

[[:SOURCE<hw>]:BB:EUTRa:DL:EMTC:BMP:SElectIall|DESelectall

Sets all SFs as valid or invalid.

Example: See [Example"eMTC valid subframes and hopping configuration"](#) on page 813.

Usage: Event

Manual operation: See ["Select All/Deselect All"](#) on page 430

[:SOURCE<hw>]:BB:EUTRa:DL:EMTC:BMP:VALSubframes<ch>
 <ValidSubFrames>

Sets a SF as valid or invalid.

Parameters:

<ValidSubFrames> 1 | ON | 0 | OFF

*RST: 1

Example: See [Example"eMTC valid subframes and hopping configuration"](#) on page 813.

Manual operation: See ["SF State"](#) on page 430

[:SOURCE<hw>]:BB:EUTRa:DL:EMTC:NB:NNBands?

Queries the number of narrowbands.

Return values:

<NumNarrowBands> integer

Range: 1 to 16

*RST: 8

Example: See [Example"eMTC valid subframes and hopping configuration"](#) on page 813.

Usage: Query only

Manual operation: See ["Number of eMTC Narrowbands"](#) on page 430

[:SOURCE<hw>]:BB:EUTRa:DL:EMTC:NB:HOPping <NumNBHopping>

Sets the number of narrowbands over which MPDCCH or PDSCH hops.

Parameters:

<NumNBHopping> 2 | 4

*RST: 2

Example: See [Example"eMTC valid subframes and hopping configuration"](#) on page 813.

Manual operation: See ["Number of Narrowbands for Hopping"](#) on page 430

[:SOURCE<hw>]:BB:EUTRa:DL:EMTC:NB:HOFFset <HoppingOffset>

Sets the number of narrowbands between two consecutive MPDCCH or PDSCH hops.

Parameters:

<HoppingOffset> integer
 Range: 1 to 16
 *RST: 8

Example: See [Example"eMTC valid subframes and hopping configuration"](#) on page 813.

Manual operation: See ["Hopping Offset"](#) on page 430

[:SOURCE<hw>]:BB:EUTRa:DL:EMTC:NB:IVLA <HoppingIVLA>

[:SOURCE<hw>]:BB:EUTRa:DL:EMTC:NB:IVLB <HoppingIVLB>

Sets the number of consecutive subframes during which MPDCCH or PDSCH stays at the same narrowband before hopping to another narrowband.

Parameters:

<HoppingIVB> H1 | H2 | H4 | H5 | H8 | H10 | H16 | H20 | H40
 *RST: H2

Example: See [Example"eMTC valid subframes and hopping configuration"](#) on page 813.

Manual operation: See ["Hopping Interval for CE Mode A/B"](#) on page 431

[:SOURCE<hw>]:BB:EUTRa:DL:EMTC:NB:PHOPping <PagingHopping>

[:SOURCE<hw>]:BB:EUTRa:DL:EMTC:NB:RHOPping <RaHopping>

Enables hopping for the random access.

Parameters:

<RaHopping> 1 | ON | 0 | OFF
 *RST: 1

Example: See [Example"eMTC valid subframes and hopping configuration"](#) on page 813.

Manual operation: See ["RA Hopping"](#) on page 431

[:SOURCE<hw>]:BB:EUTRa:DL:EMTC:NB:PSTNb <PagingStartingN>

[:SOURCE<hw>]:BB:EUTRa:DL:EMTC:NB:RSTNb <RaStartingNB>

Sets the first used narrowband, if hopping is enabled.

Parameters:

<RaStartingNB> integer
 Range: 0 to 15
 *RST: 8

Example: See [Example"eMTC valid subframes and hopping configuration"](#) on page 813.

Manual operation: See ["RA Starting NB"](#) on page 431

```
[ :SOURCE<hw>]:BB:EUTRa:DL:EMTC:SSP:MPD1 <MaxRepMPDCCH1>
```

```
[ :SOURCE<hw>]:BB:EUTRa:DL:EMTC:SSP:MPD2 <MaxRepMPDCCH2>
```

Sets the maximum number of MPDCCH repetitions for type 1 and type 2 common search spaces.

Parameters:

```
<MaxRepMPDCCH2> 1 | 2 | 4 | 8 | 16 | 32 | 64 | 128 | 256
```

```
*RST: 1
```

Example: See [Example "eMTC valid subframes and hopping configuration"](#) on page 813.

Manual operation: See ["Max. Repetitions of MPDCCH \(Rmax\) for Type 2 common search space"](#) on page 432

```
[ :SOURCE<hw>]:BB:EUTRa:DL:EMTC:SSP:STSF <SpStartSf>
```

Sets the start SF for the random access common search space.

Parameters:

```
<SpStartSf> S1 | S1_5 | S2 | S2_5 | S5 | S8 | S10 | S20 | S4
```

```
*RST: S1
```

Example: See [Example "eMTC valid subframes and hopping configuration"](#) on page 813.

Manual operation: See ["Search Space Start Subframe"](#) on page 432

```
[ :SOURCE<hw>]:BB:EUTRa:DL:EMTC:SSP:PDSA <MaxRepPDSCHA>
```

Sets the parameter `pdsch-maxNumRepetitionCEmodeA` that defines the PDSCH subframe assignment.

Parameters:

```
<MaxRepPDSCHA> 16 | 32 | 64 | NON | 192 | 256 | 384 | 512 | 786 | 1024 | 1536 | 2048
```

```
*RST: NON
```

Example: See [Example "eMTC valid subframes and hopping configuration"](#) on page 813.

Manual operation: See ["Max. Repetitions of PDSCH for CE Mode A/B"](#) on page 433

```
[ :SOURCE<hw>]:BB:EUTRa:DL:EMTC:SSP:PDSB <MaxRepPDSCHB>
```

Sets the parameter `pdsch-maxNumRepetitionCEmodeB` that defines the PDSCH subframe assignment.

Parameters:

<MaxRepPDSCHB> 16 | 32 | 64 | NON | 192 | 256 | 384 | 512 | 786 | 1024 | 1536 | 2048

*RST: NON

Example:

See [Example "eMTC valid subframes and hopping configuration"](#) on page 813.

Manual operation:

See ["Max. Repetitions of PDSCH for CE Mode A/B"](#) on page 433

10.27.2 DL IoT frame configuration

10.27.2.1 NB-IoT DCI configuration

[SOURce<hw>]:BB:EUTRa:DL:NIOT:DCI:NALLoc.....	844
[SOURce<hw>]:BB:EUTRa:DL:NIOT:DCI:AWARound.....	844
[SOURce<hw>]:BB:EUTRa:DL:NIOT:DCI:ALLoc<ch0>:USER.....	844
[SOURce<hw>]:BB:EUTRa:DL:NIOT:DCI:ALLoc<ch0>:UEID?.....	844
[SOURce<hw>]:BB:EUTRa:DL:NIOT:DCI:ALLoc<ch0>:FMT.....	845
[SOURce<hw>]:BB:EUTRa:DL:NIOT:DCI:ALLoc<ch0>:SSP.....	845
[SOURce<hw>]:BB:EUTRa:DL:NIOT:DCI:ALLoc<ch0>:STSFrame.....	845
[SOURce<hw>]:BB:EUTRa:DL:NIOT:DCI:ALLoc<ch0>:NPDCch:FMT.....	845
[SOURce<hw>]:BB:EUTRa:DL:NIOT:DCI:ALLoc<ch0>:CCES?.....	846
[SOURce<hw>]:BB:EUTRa:DL:NIOT:DCI:ALLoc<ch0>:IDCCe.....	846
[SOURce<hw>]:BB:EUTRa:DL:NIOT:DCI:ALLoc<ch0>:CONFLict?.....	846
[SOURce<hw>]:BB:EUTRa:DL:NIOT:DCI:ALLoc<ch0>:BITS?.....	847
[SOURce<hw>]:BB:EUTRa:DL:NIOT:DCI:ALLoc<ch0>:IRU.....	847
[SOURce<hw>]:BB:EUTRa:DL:NIOT:DCI:ALLoc<ch0>:HACK.....	847
[SOURce<hw>]:BB:EUTRa:DL:NIOT:DCI:ALLoc<ch0>:IDELay.....	847
[SOURce<hw>]:BB:EUTRa:DL:NIOT:DCI:ALLoc<ch0>:MCSCHEME.....	848
[SOURce<hw>]:BB:EUTRa:DL:NIOT:DCI:ALLoc<ch0>:NDINd.....	848
[SOURce<hw>]:BB:EUTRa:DL:NIOT:DCI:ALLoc<ch0>:NPDCch:OIND.....	848
[SOURce<hw>]:BB:EUTRa:DL:NIOT:DCI:ALLoc<ch0>:NPDCch:REP?.....	848
[SOURce<hw>]:BB:EUTRa:DL:NIOT:DCI:ALLoc<ch0>:NPDSch:IREP.....	849
[SOURce<hw>]:BB:EUTRa:DL:NIOT:DCI:ALLoc<ch0>:NPDSch:ISF.....	849
[SOURce<hw>]:BB:EUTRa:DL:NIOT:DCI:ALLoc<ch0>:NPDSch:NREP?.....	849
[SOURce<hw>]:BB:EUTRa:DL:NIOT:DCI:ALLoc<ch0>:NPDSch:NSF?.....	850
[SOURce<hw>]:BB:EUTRa:DL:NIOT:DCI:ALLoc<ch0>:NPRach:SCINd.....	850
[SOURce<hw>]:BB:EUTRa:DL:NIOT:DCI:ALLoc<ch0>:NPRach:SNUMber.....	850
[SOURce<hw>]:BB:EUTRa:DL:NIOT:DCI:ALLoc<ch0>:NPUSch:IREP.....	850
[SOURce<hw>]:BB:EUTRa:DL:NIOT:DCI:ALLoc<ch0>:NRUNits?.....	851
[SOURce<hw>]:BB:EUTRa:DL:NIOT:DCI:ALLoc<ch0>:NDINd.....	851
[SOURce<hw>]:BB:EUTRa:DL:NIOT:DCI:ALLoc<ch0>:HPNMber.....	851
[SOURce<hw>]:BB:EUTRa:DL:NIOT:DCI:ALLoc<ch0>:PAG.....	852
[SOURce<hw>]:BB:EUTRa:DL:NIOT:DCI:ALLoc<ch0>:RVERsion.....	852
[SOURce<hw>]:BB:EUTRa:DL:NIOT:DCI:ALLoc<ch0>:SCINd.....	852
[SOURce<hw>]:BB:EUTRa:DL:NIOT:DCI:ALLoc<ch0>:SFRPt.....	852

<code>[:SOURce<hw>]:BB:EUTRa:DL:NIOT:DCI:ALlOc<ch0>:SIME</code>	853
<code>[:SOURce<hw>]:BB:EUTRa:DL:NIOT:DCI:ALlOc<ch0>:SINF</code>	853
<code>[:SOURce<hw>]:BB:EUTRa:DL:NIOT:DCI:ALlOc<ch0>:TBSZ?</code>	853
<code>[:SOURce<hw>]:BB:EUTRa:DL:NIOT:DCI:ALlOc<ch0>:DIST</code>	854

`[:SOURce<hw>]:BB:EUTRa:DL:NIOT:DCI:NAlLoc <NoAlloc>`

Sets the number of configurable DCIs.

Parameters:

`<NoAlloc>` integer
 Range: 0 to 100
 *RST: 0

Example: See [Example"NPDCCH and NPDSCH DCI-based configuration \(DCI format N1\)"](#) on page 803.

Manual operation: See ["Number of DCI Allocations"](#) on page 381

`[:SOURce<hw>]:BB:EUTRa:DL:NIOT:DCI:AWARound <AllocWrapAround>`

If enabled, the NPDSCH allocations are relocated at the beginning of the ARB sequence to ensure a consistent signal.

Parameters:

`<AllocWrapAround>` 1 | ON | 0 | OFF
 *RST: 0

Example: `SOURce1:BB:EUTRa:DL:NIOT:DCI:AWARound 1`

`[:SOURce<hw>]:BB:EUTRa:DL:NIOT:DCI:ALlOc<ch0>:USER <User>`

Selects the user the DCI is dedicated to.

Parameters:

`<User>` USER1 | USER2 | USER3 | USER4 | PRNTi | RARNti
 *RST: USER1

Example: See [Example"NPDCCH and NPDSCH DCI-based configuration \(DCI format N1\)"](#) on page 803.

Manual operation: See ["User"](#) on page 381

`[:SOURce<hw>]:BB:EUTRa:DL:NIOT:DCI:ALlOc<ch0>:UEID?`

Queries the UE_ID or the n_RNTI for the selected DCI.

Return values:

`<UeID>` integer
 Range: 0 to 65535
 *RST: 0

Example: See [Example"NPDCCH and NPDSCH DCI-based configuration \(DCI format N1\)"](#) on page 803.

Usage: Query only

Manual operation: See ["UE_ID/n_RNTI"](#) on page 381

[:SOURCE<hw>]:BB:EUTRa:DL:NIOT:DCI:ALLoc<ch0>:FMT <Format>

Sets the DCI format for the selected allocation.

Parameters:

<Format> N0 | N1 | N2
*RST: N0

Example: See [Example"NPDCCH and NPDSCH DCI-based configuration \(DCI format N1\)"](#) on page 803.

Manual operation: See ["DCI Format"](#) on page 381

[:SOURCE<hw>]:BB:EUTRa:DL:NIOT:DCI:ALLoc<ch0>:SSP <SearchSpace>

Sets the search space for the selected DCI.

Parameters:

<SearchSpace> UE | T1CM | T2CM
*RST: UE

Example: See [Example"NPDCCH and NPDSCH DCI-based configuration \(DCI format N1\)"](#) on page 803.

Manual operation: See ["Search Space"](#) on page 382

[:SOURCE<hw>]:BB:EUTRa:DL:NIOT:DCI:ALLoc<ch0>:STSFrame <StartSf>

Sets the next valid starting subframe for the selected allocation.

Parameters:

<StartSf> integer
Range: 1 to 20
*RST: 1

Example: See [Example"NPDCCH and NPDSCH DCI-based configuration \(DCI format N1\)"](#) on page 803.

Manual operation: See ["Start Sufbrame"](#) on page 392

[:SOURCE<hw>]:BB:EUTRa:DL:NIOT:DCI:ALLoc<ch0>:NPDCch:FMT <NPdcchFmt>

Sets the NPDCCH format.

Parameters:

<NPdcchFmt> integer
 Range: 0 to 1
 *RST: 0

Example: See [Example"NPDCCH and NPDSCH DCI-based configuration \(DCI format N1\)"](#) on page 803.

Manual operation: See ["NPDCCH Format"](#) on page 392

[:SOURCE<hw>]:BB:EUTRa:DL:NIOT:DCI:ALLoc<ch0>:CCES?

queries the number NCCEs.

Return values:

<NoCCEs> integer
 Range: 1 to 2
 *RST: 1

Example: See [Example"NPDCCH and NPDSCH DCI-based configuration \(DCI format N1\)"](#) on page 803.

Usage: Query only

Manual operation: See ["Number NCCEs"](#) on page 393

[:SOURCE<hw>]:BB:EUTRa:DL:NIOT:DCI:ALLoc<ch0>:IDCCe <NccelIndex>

Sets the NCCE start index.

Parameters:

<NccelIndex> integer
 Range: 0 to 1
 *RST: 0

Example: See [Example"NPDCCH and NPDSCH DCI-based configuration \(DCI format N1\)"](#) on page 803.

Manual operation: See ["NCCE Index"](#) on page 393

[:SOURCE<hw>]:BB:EUTRa:DL:NIOT:DCI:ALLoc<ch0>:CONFLICT?

Queries if there is a conflict between two DCI formats.

Return values:

<Conflict> 1 | ON | 0 | OFF
 *RST: 0

Example: SOURCE1:BB:EUTRa:DL:NIOT:DCI:ALLoc1:CONFLICT?

Usage: Query only

Manual operation: See ["Conflict"](#) on page 393

[:SOURce<hw>]:BB:EUTRa:DL:NIOT:DCI:ALLoc<ch0>:BITS?

Queries the resulting bit data as selected with the DCI format parameters.

Return values:

<BitData> string

Example: See [Example "NPDCCH and NPDSCH DCI-based configuration \(DCI format N1\)"](#) on page 803.

Usage: Query only

Manual operation: See ["Bit Data"](#) on page 383

[:SOURce<hw>]:BB:EUTRa:DL:NIOT:DCI:ALLoc<ch0>:IRU <DciIRU>

Sets the DCI field resource assignment field of NPUSCH (I_{RU}).

Parameters:

<DciIRU> integer
 Range: 0 to 7
 *RST: 0

Example: See [Example "DCI format N0 configuration"](#) on page 802.

Manual operation: See ["DCI Format N0"](#) on page 383

[:SOURce<hw>]:BB:EUTRa:DL:NIOT:DCI:ALLoc<ch0>:HACK <HackResource>

Sets the DCI field HARQ-ACK resource field.

Parameters:

<HackResource> integer
 Range: 0 to 15
 *RST: 0

Example: See [Example "NPDCCH and NPDSCH DCI-based configuration \(DCI format N1\)"](#) on page 803.

Manual operation: See ["DCI Format N1"](#) on page 385

[:SOURce<hw>]:BB:EUTRa:DL:NIOT:DCI:ALLoc<ch0>:IDELay <SchedDelay>

Sets the DCI field scheduling delay field (I_{Delay}).

Parameters:

<SchedDelay> integer
 Range: 0 to 7
 *RST: 0

Example: See [Example "DCI format N0 configuration"](#) on page 802.

Manual operation: See ["DCI Format N0"](#) on page 383
 See ["DCI Format N1"](#) on page 385

[[:SOURce<hw>]:BB:EUTRa:DL:NIOT:DCI:ALLoc<ch0>:MCSCHEME <Scheme>

Sets the DCI field modulation and coding scheme (I_{MSC}).

Parameters:

<Scheme> integer
 Range: 0 to 13
 *RST: 0

Example: See [Example "NPDCCH and NPDSCH DCI-based configuration \(DCI format N1\)"](#) on page 803.

Manual operation: See ["DCI Format N0"](#) on page 383
 See ["DCI Format N1"](#) on page 385
 See ["DCI Format N2"](#) on page 389

[[:SOURce<hw>]:BB:EUTRa:DL:NIOT:DCI:ALLoc<ch0>:NDIND <NewDataInd>

Sets the DCI field new data indicator.

Parameters:

<NewDataInd> 1 | ON | 0 | OFF
 *RST: 0

Example: See [Example "NPDCCH and NPDSCH DCI-based configuration \(DCI format N1\)"](#) on page 803.

Manual operation: See ["DCI Format N0"](#) on page 383
 See ["DCI Format N1"](#) on page 385

[[:SOURce<hw>]:BB:EUTRa:DL:NIOT:DCI:ALLoc<ch0>:NPDCch:OIND <OrderInd>

Sets the DCI field NPDCCH order indicator.

Parameters:

<OrderInd> 1 | ON | 0 | OFF
 *RST: 0

Example: See [Example "NPDCCH and NPDSCH DCI-based configuration \(DCI format N1\)"](#) on page 803.

Manual operation: See ["DCI Format N1"](#) on page 385

[[:SOURce<hw>]:BB:EUTRa:DL:NIOT:DCI:ALLoc<ch0>:NPDCch:REP?

Queries the number of repetitions of NPDCCH (R).

Return values:

<NPdcchRpt> integer
 Range: 1 to 2048
 *RST: 1

Example: See [Example "DCI format N2 configuration"](#) on page 806.

Usage: Query only

Manual operation: See ["Repetitions of NPDCCH \(R\)"](#) on page 392

**[:SOURce<hw>]:BB:EUTRa:DL:NIOT:DCI:ALLoc<ch0>:NPDSch:IREP
<DciINPDSCH>**

Sets the DCI field number of NPDSCH repetition fields (I_{Rep}).

Parameters:

<DciINPDSCH> integer
 Range: 0 to 15
 *RST: 0

Example: See [Example"NPDCCH and NPDSCH DCI-based configuration \(DCI format N1\)"](#) on page 803.

Manual operation: See ["DCI Format N1"](#) on page 385
 See ["DCI Format N2"](#) on page 389

[:SOURce<hw>]:BB:EUTRa:DL:NIOT:DCI:ALLoc<ch0>:NPDSch:ISF <DciISF>

Sets the DCI feild resource assignment field (I_{SF}).

Parameters:

<DciISF> integer
 Range: 0 to 7
 *RST: 0

Example: See [Example"NPDCCH and NPDSCH DCI-based configuration \(DCI format N1\)"](#) on page 803.

Manual operation: See ["DCI Format N1"](#) on page 385
 See ["DCI Format N2"](#) on page 389

[:SOURce<hw>]:BB:EUTRa:DL:NIOT:DCI:ALLoc<ch0>:NPDSch:NREP?

Queries the number of repetitions of NPDSCH (N_{Rep} .)

Return values:

<NPdschRpt> integer
 Range: 1 to 2048
 *RST: 1

Example: See [Example"NPDCCH and NPDSCH DCI-based configuration \(DCI format N1\)"](#) on page 803.

Usage: Query only

Manual operation: See ["Repetitions of NPDSCH \(\$N_{Rep}\$ \)"](#) on page 392

[[:SOURce<hw>]:BB:EUTRa:DL:NIOT:DCI:ALLoc<ch0>:NPDSch:NSF?

queries the number of NPDSCH subframes (N_{SF}).

Return values:

<NoSubframes> integer
 Range: 1 to 10
 *RST: 1

Example: See [Example "NPDCCH and NPDSCH DCI-based configuration \(DCI format N1\)"](#) on page 803.

Usage: Query only

Manual operation: See ["Number of NPDSCH Subframes \(\$N_{SF}\$ \)"](#) on page 392

**[[:SOURce<hw>]:BB:EUTRa:DL:NIOT:DCI:ALLoc<ch0>:NPRach:SCIND
 <SubcarrierInd>**

Sets the DCI field subcarrier indication field of NPRACH (I_{SC}).

Parameters:

<SubcarrierInd> integer
 Range: 0 to 47
 *RST: 0

Example: See [Example "NPDCCH and NPDSCH DCI-based configuration \(DCI format N1\)"](#) on page 803.

Manual operation: See ["DCI Format N1"](#) on page 385

**[[:SOURce<hw>]:BB:EUTRa:DL:NIOT:DCI:ALLoc<ch0>:NPRach:SNUMBER
 <StartingNumber>**

Sets the DCI field starting number of NPRACH repetitions (I_{Rep}).

Parameters:

<StartingNumber> integer
 Range: 0 to 2
 *RST: 0

Example: See [Example "NPDCCH and NPDSCH DCI-based configuration \(DCI format N1\)"](#) on page 803.

Manual operation: See ["DCI Format N1"](#) on page 385

**[[:SOURce<hw>]:BB:EUTRa:DL:NIOT:DCI:ALLoc<ch0>:NPUSch:IREP
 <DciINPUSCH>**

Sets the DCI field number of NPUSCH repetition fields (I_{Rep}).

Parameters:

<DciINPUSCH> integer
 Range: 0 to 7
 *RST: 0

Example: See [Example"DCI format N0 configuration"](#) on page 802.

Manual operation: See ["DCI Format N0"](#) on page 383

[:SOURce<hw>]:BB:EUTRa:DL:NIOT:DCI:ALLoc<ch0>:NRUNits?

Queries the number of resource units (N_{RU}).

Return values:

<NoResUnits> integer
 Range: 1 to 10
 *RST: 1

Example: See [Example"DCI format N0 configuration"](#) on page 802.

Usage: Query only

Manual operation: See ["Number of Resource Units \(\$N_{RU}\$ \)"](#) on page 391

[:SOURce<hw>]:BB:EUTRa:DL:NIOT:DCI:ALLoc<ch0>:NDINd <NewDataInd>

Sets the DCI field new data indicator.

Parameters:

<NewDataInd> 1 | ON | 0 | OFF
 *RST: 0

Example: See [Example"NPDCCH and NPDSCH DCI-based configuration \(DCI format N1\)"](#) on page 803.

Manual operation: See ["DCI Format N0"](#) on page 383
 See ["DCI Format N1"](#) on page 385

[:SOURce<hw>]:BB:EUTRa:DL:NIOT:DCI:ALLoc<ch0>:HPNNumber <HarqProcessNum>

Sets the HARQ processes number, for UEs for that [\[:SOURce<hw>\]:BB:EUTRa:DL:USER<ch>:STHP:STATe1](#).

Parameters:

<HarqProcessNum> integer
 Range: 0 to 1
 *RST: 0

Example: See [Example"DCI format N0 configuration"](#) on page 802.

Options: R&S SMM-K143

Manual operation: See ["DCI Format N0"](#) on page 383
See ["DCI Format N1"](#) on page 385

[:SOURCE<hw>]:BB:EUTRa:DL:NIOT:DCI:ALLoc<ch0>:PAG <Paging>

Sets the DCI field flag for paging/direct indication.

Parameters:

<Paging> 1 | ON | 0 | OFF
1
Paging
0
Direct indication
*RST: 0

Example: See [Example"DCI format N2 configuration"](#) on page 806.

Manual operation: See ["DCI Format N2"](#) on page 389

[:SOURCE<hw>]:BB:EUTRa:DL:NIOT:DCI:ALLoc<ch0>:RVERsion
<RedundancyVers>

Sets the DCI field redundancy version.

Parameters:

<RedundancyVers> integer
Range: 0 to 1
*RST: 0

Example: See [Example"DCI format N0 configuration"](#) on page 802.

Manual operation: See ["DCI Format N0"](#) on page 383

[:SOURCE<hw>]:BB:EUTRa:DL:NIOT:DCI:ALLoc<ch0>:SCINd <SubcarrierInd>

Sets the DCI field subcarrier identification field of NPUSCH (I_{sc}).

Parameters:

<SubcarrierInd> integer
Range: 0 to 47
*RST: 0

Example: See [Example"NPDCCH and NPDSCH DCI-based configuration \(DCI format N1\)"](#) on page 803.

Manual operation: See ["DCI Format N0"](#) on page 383

[:SOURCE<hw>]:BB:EUTRa:DL:NIOT:DCI:ALLoc<ch0>:SFRPt <SfRepetition>

Sets the DCI field repetitions of DCI subframes.

Parameters:

<SfRepetition> integer
 Range: 0 to 7
 *RST: 0

Example: See [Example"NPDCCH and NPDSCH DCI-based configuration \(DCI format N1\)"](#) on page 803.

Manual operation: See ["DCI Format N0"](#) on page 383
 See ["DCI Format N1"](#) on page 385
 See ["DCI Format N2"](#) on page 389

[:SOURCE<hw>]:BB:EUTRa:DL:NIOT:DCI:ALLoc<ch0>:SIME <SysInfModExt>

Sets the DCI field system info modification - extended discontinuous reception.

Parameters:

<SysInfModExt> 1 | ON | 0 | OFF
 *RST: 0

Example: See [Example"DCI format N2 configuration"](#) on page 806.

Manual operation: See ["DCI Format N2"](#) on page 389

[:SOURCE<hw>]:BB:EUTRa:DL:NIOT:DCI:ALLoc<ch0>:SINF <SysInfMod>

Sets the DCI field system info modification.

Parameters:

<SysInfMod> 1 | ON | 0 | OFF
 *RST: 0

Example: See [Example"DCI format N2 configuration"](#) on page 806.

Manual operation: See ["DCI Format N2"](#) on page 389

[:SOURCE<hw>]:BB:EUTRa:DL:NIOT:DCI:ALLoc<ch0>:TBSZ?

Queries the transport block size.

Return values:

<TransportBlockS> integer
 Max transport block size depends on the installed options
 Option:R&S SMM-K115: Max = 680
 Option:R&S SMM-K143: Max = 2536
 Range: 16 to max
 *RST: 16

Example: See [Example"NPDCCH and NPDSCH DCI-based configuration \(DCI format N1\)"](#) on page 803.

Usage: Query only

Manual operation: See ["DCI Format N1"](#) on page 385
See ["Transport Block Size"](#) on page 391

[:SOURce<hw>]:BB:EUTRa:DL:NIOT:DCI:ALLoc<ch0>:DIST <DistNpdccchNpdsc>

Sets how the distance between the NPDCCH to NPDSCH is determined.

Parameters:

<DistNpdccchNpdsc> STD | MIN | ZERO

ZERO disables the NPDSCH SIB1-NR and NPUCCH transmissions. The NPDSCH is transmitted immediately after the NPDCCH.

Use this value to increase the number of NPDSCH allocations.

*RST: STD

Example:

SOURce1:BB:EUTRa:DL:NIOT:DCI:ALLoc0:FMT N1

SOURce1:BB:EUTRa:DL:NIOT:DCI:ALLoc0:DIST STD

Manual operation: See ["Distance from NPDCCH to NPDSCH"](#) on page 391

10.27.2.2 NB-IoT allocation

[:SOURce<hw>]:BB:EUTRa:DL:NIOT:NALLoc?	854
[:SOURce<hw>]:BB:EUTRa:DL:NIOT:ALLoc<ch0>:CONType?	855
[:SOURce<hw>]:BB:EUTRa:DL:NIOT:ALLoc<ch0>:MODulation?	855
[:SOURce<hw>]:BB:EUTRa:DL:NIOT:ALLoc<ch0>:SFList?	855
[:SOURce<hw>]:BB:EUTRa:DL:NIOT:ALLoc<ch0>:STSYmbol	855
[:SOURce<hw>]:BB:EUTRa:DL:NIOT:ALLoc<ch0>:PHYSbits?	856
[:SOURce<hw>]:BB:EUTRa:DL:NIOT:ALLoc<ch0>:POWER	856
[:SOURce<hw>]:BB:EUTRa:DL:NIOT:ALLoc<ch0>:DATA	856
[:SOURce<hw>]:BB:EUTRa:DL:NIOT:ALLoc<ch0>:DSElect	857
[:SOURce<hw>]:BB:EUTRa:DL:NIOT:ALLoc<ch0>:PATTern	857
[:SOURce<hw>]:BB:EUTRa:DL:NIOT:ALLoc<ch0>:STATe?	857
[:SOURce<hw>]:BB:EUTRa:DL:NIOT:ALLoc<ch0>:CONFlit?	857

[:SOURce<hw>]:BB:EUTRa:DL:NIOT:NALLoc?

Queries the number of NB-IoT allocations.

Return values:

<NbIoTNAIAlloc> integer
Range: 0 to 42
*RST: 1

Example: See [Example "NPDCCH and NPDSCH DCI-based configuration \(DCI format N1\)"](#) on page 803.

Usage: Query only

Manual operation: See ["Allocation number"](#) on page 394

[:SOURce<hw>]:BB:EUTRa:DL:NIOT:ALLoc<ch0>:CONType?

Queries the channel type.

Return values:

<ContentType> NPBCh | NSIB | NPDCch | NPDSch
*RST: NPBCh

Example: See [Example"NPDCCH and NPDSCH DCI-based configuration \(DCI format N1\)"](#) on page 803.

Usage: Query only

Manual operation: See ["Content Type"](#) on page 394

[:SOURce<hw>]:BB:EUTRa:DL:NIOT:ALLoc<ch0>:MODulation?

Queries the used modulation scheme.

Return values:

<Modulation> QPSK
*RST: QPSK

Example: See [Example"NPDCCH and NPDSCH DCI-based configuration \(DCI format N1\)"](#) on page 803.

Usage: Query only

Manual operation: See ["Modulation"](#) on page 395

[:SOURce<hw>]:BB:EUTRa:DL:NIOT:ALLoc<ch0>:SFList?

Queries the subframes in that the channel is allocated.

Return values:

<SubframeList> "<SF#>, <SF#>, <SF#>, <SF#>..."
String of four comma-separated integer values, indicating sub-frame numbers

Example: See [Example"NPDCCH and NPDSCH DCI-based configuration \(DCI format N1\)"](#) on page 803.

Usage: Query only

Manual operation: See ["Suframe List"](#) on page 395

[:SOURce<hw>]:BB:EUTRa:DL:NIOT:ALLoc<ch0>:STSYmbol <StartSymbol>

Sets the first symbol in a subframe where NB-LoT channels can be allocated.

Parameters:

<StartSymbol> SYM0 | SYM1 | SYM2 | SYM3
*RST: SYM0

Example: See [Example"NPDCCH and NPDSCH DCI-based configuration \(DCI format N1\)"](#) on page 803.

Manual operation: See ["Start Symbol"](#) on page 395

[[:SOURce<hw>]:BB:EUTRa:DL:NIOT:ALLoc<ch0>:PHYSbits?

Queries the used number of physical bits.

Return values:

<PhysicalBits> integer
 Range: 0 to 320
 *RST: 200

Example: See [Example"NPDCCH and NPDSCH DCI-based configuration \(DCI format N1\)"](#) on page 803.

Usage: Query only

Manual operation: See ["Phys. Bits"](#) on page 396
 See ["Number of Physical Bits"](#) on page 400
 See ["Number of Physical Bits"](#) on page 405

[[:SOURce<hw>]:BB:EUTRa:DL:NIOT:ALLoc<ch0>:POWER <Power>

Sets the power of the selected allocation.

Parameters:

<Power> float
 Range: -80 to 10
 Increment: 0.01
 *RST: 0

Example: See [Example"NPDCCH and NPDSCH DCI-based configuration \(DCI format N1\)"](#) on page 803.

Manual operation: See ["p A"](#) on page 397

[[:SOURce<hw>]:BB:EUTRa:DL:NIOT:ALLoc<ch0>:DATA <DataSource>

Queries the data source or sets the data source for NPDSCH allocations configured for P-RNTI or RA-RNTI.

Parameters:

<DataSource> USER1 | USER2 | USER3 | USER4 | PN9 | PN11 | PN15 |
 PN16 | PN20 | PN21 | PN23 | PATtern | DLISt | ZERO | ONE |
 MIB | SIB1nb | PRNTi | RARNti
 *RST: MIB

Example: See [Example"NPDCCH and NPDSCH DCI-based configuration \(DCI format N1\)"](#) on page 803.

Manual operation: See ["Data Source"](#) on page 396

[:SOURCE<hw>]:BB:EUTRa:DL:NIOT:ALLoc<ch0>:DSElect <DataList>

Selects an existing data list file from the default directory or from the specific directory.

Parameters:

<DataList> string
 Filename incl. file extension or complete file path

Example:

```
SOURce1:BB:EUTRa:DL:NIOT:DCI:ALLoc0:USER PRNT
SOURce1:BB:EUTRa:DL:NIOT:ALLoc3:DATA DLIS
SOURce1:BB:EUTRa:DL:NIOT:ALLoc3:DSElect "/var/user/IoT.dm_iqd"
```

Manual operation: See ["Data Source"](#) on page 396

[:SOURCE<hw>]:BB:EUTRa:DL:NIOT:ALLoc<ch0>:PATTern <Pattern>, <BitCount>

Sets a bit pattern as data source.

Parameters:

<Pattern> numeric
 *RST: #H0

<BitCount> integer
 Range: 1 to 64
 *RST: 1

Example:

```
SOURce1:BB:EUTRa:DL:NIOT:DCI:ALLoc0:USER PRNT
SOURce1:BB:EUTRa:DL:NIOT:ALLoc3:DATA PATT
SOURce1:BB:EUTRa:DL:NIOT:ALLoc3:PATTern #H735,12
```

Manual operation: See ["Data Source"](#) on page 396

[:SOURCE<hw>]:BB:EUTRa:DL:NIOT:ALLoc<ch0>:STATE?

Queries the allocation state.

Return values:

<State> 1 | ON | 0 | OFF
 *RST: 1

Example: See [Example "NPDCCH and NPDSCH DCI-based configuration \(DCI format N1\)"](#) on page 803.

Usage: Query only

Manual operation: See ["State"](#) on page 397

[:SOURCE<hw>]:BB:EUTRa:DL:NIOT:ALLoc<ch0>:CONFLICT?

Queries if there is a conflict between allocations.

Return values:

<Conflict> 1 | ON | 0 | OFF
 *RST: 0

Example: See [Example"NPDCCH and NPDSCH DCI-based configuration \(DCI format N1\)"](#) on page 803.

Usage: Query only

Manual operation: See ["Conflict"](#) on page 397

10.27.2.3 NPBCH, NPDCCH, NPDSCH enhanced settings

[:SOURce<hw>]:BB:EUTRa:DL:NIOT:ALLoc<ch0>:PRECoding:SCHEME.....	858
[:SOURce<hw>]:BB:EUTRa:DL:NIOT:ALLoc<ch0>:PRECoding:NOLayers?.....	858
[:SOURce<hw>]:BB:EUTRa:DL:NIOT:ALLoc<ch0>:SCRambling:STATE.....	859
[:SOURce<hw>]:BB:EUTRa:DL:NIOT:ALLoc<ch0>:SCRambling:SROT.....	859
[:SOURce<hw>]:BB:EUTRa:DL:NIOT:ALLoc<ch0>:SCRambling:UEID?.....	859
[:SOURce<hw>]:BB:EUTRa:DL:NIOT:ALLoc<ch0>:SCRambling:LEGacy:STATE.....	860
[:SOURce<hw>]:BB:EUTRa:DL:NIOT:ALLoc<ch0>:CCODing:STATE.....	860
[:SOURce<hw>]:BB:EUTRa:DL:NIOT:ALLoc<ch0>:CCODing:ISF?.....	860
[:SOURce<hw>]:BB:EUTRa:DL:NIOT:ALLoc<ch0>:CCODing:NSF?.....	861
[:SOURce<hw>]:BB:EUTRa:DL:NIOT:ALLoc<ch0>:CCODing:TBSI.....	861
[:SOURce<hw>]:BB:EUTRa:DL:NIOT:ALLoc<ch0>:CCODing:TBSIze?.....	861
[:SOURce<hw>]:BB:EUTRa:DL:NIOT:CCODing:MIB.....	861
[:SOURce<hw>]:BB:EUTRa:DL:NIOT:CCODing:MSPare.....	862
[:SOURce<hw>]:BB:EUTRa:DL:NIOT:CCODing:NCID?.....	862
[:SOURce<hw>]:BB:EUTRa:DL:NIOT:CCODing:RSIB?.....	862
[:SOURce<hw>]:BB:EUTRa:DL:NIOT:CCODing:SIB.....	862
[:SOURce<hw>]:BB:EUTRa:DL:NIOT:CCODing:SOFFset.....	863
[:SOURce<hw>]:BB:EUTRa:DL:NIOT:CCODing:STFSib1?.....	863

[:SOURce<hw>]:BB:EUTRa:DL:NIOT:ALLoc<ch0>:PRECoding:SCHEME
 <PrecAntScheme>

Sets the precoding scheme.

Parameters:

<PrecAntScheme> NONE | TXD
 *RST: NONE

Example: See [Example"NPDCCH and NPDSCH DCI-based configuration \(DCI format N1\)"](#) on page 803.

Manual operation: See ["Precoding Scheme"](#) on page 399
 See ["Precoding Scheme"](#) on page 403

[:SOURce<hw>]:BB:EUTRa:DL:NIOT:ALLoc<ch0>:PRECoding:NOLayers?

Queries the number of layers for the selected allocation.

Return values:

<NoLayers> integer
 Range: 1 to 2
 *RST: 1

Example: See [Example "NPDCCH and NPDSCH DCI-based configuration \(DCI format N1\)"](#) on page 803.

Usage: Query only

Manual operation: See ["Number of Layers"](#) on page 399
 See ["Number of Layers"](#) on page 403

[:SOURce<hw>]:BB:EUTRa:DL:NIOT:ALLoc<ch0>:SCRambling:STATe
 <ScramblingState>

Enables scrambling.

Parameters:

<ScramblingState> 1 | ON | 0 | OFF
 *RST: 1

Example: See [Example "NPDCCH and NPDSCH DCI-based configuration \(DCI format N1\)"](#) on page 803.

Manual operation: See ["Scrambling State"](#) on page 403

[:SOURce<hw>]:BB:EUTRa:DL:NIOT:ALLoc<ch0>:SCRambling:SROT
 <SymbolRotation>

Enables NPBCH scrambling with symbol rotation.

Parameters:

<SymbolRotation> 1 | ON | 0 | OFF
 *RST: 1

Example: See [Example "NPBCH and SIB1-NB configuration"](#) on page 807.

Manual operation: See ["NPBCH Symbol Rotation"](#) on page 399

[:SOURce<hw>]:BB:EUTRa:DL:NIOT:ALLoc<ch0>:SCRambling:UEID?

Queries the user equipment identifier (n_RNTI) or UE ID of the user to which the NPDSCH transmission is intended.

Return values:

<UEIDnRNTI> integer
 Range: 0 to 65535
 *RST: 0

Example: See [Example "NPDCCH and NPDSCH DCI-based configuration \(DCI format N1\)"](#) on page 803.

Usage: Query only
Manual operation: See ["UE ID/n_RNTI"](#) on page 403

[:SOURCE<hw>]:BB:EUTRa:DL:NIOT:ALLoc<ch0>:SCRambling:LEGacy:STATe
 <ScramState>

If disabled, scrambling according to LTE Rel. 14 is applied.

Parameters:
 <ScramState> 1 | ON | 0 | OFF
 *RST: 0

Example: See [Example"NPDCCH and NPDSCH DCI-based configuration \(DCI format N1\)"](#) on page 803.

Options: R&S SMM-K143

Manual operation: See ["Legacy Scrambling"](#) on page 404

[:SOURCE<hw>]:BB:EUTRa:DL:NIOT:ALLoc<ch0>:CCODing:STATe
 <ChanCodState>

Enables channel coding.

Parameters:
 <ChanCodState> 1 | ON | 0 | OFF
 *RST: 0

Example: See [Example"NPDCCH and NPDSCH DCI-based configuration \(DCI format N1\)"](#) on page 803.

Manual operation: See ["Channel Coding State"](#) on page 400
 See ["Channel Coding State"](#) on page 404

[:SOURCE<hw>]:BB:EUTRa:DL:NIOT:ALLoc<ch0>:CCODing:ISF?

Queries the resource assignment field (I_{SF}).

Return values:
 <RAssinField> integer
 Range: 0 to 100
 *RST: 0

Example: See [Example"NPDCCH and NPDSCH DCI-based configuration \(DCI format N1\)"](#) on page 803.

Usage: Query only

Manual operation: See ["Resource Assignment Field \(\$I_{SF}\$ \)"](#) on page 405

[:SOURce<hw>]:BB:EUTRa:DL:NIOT:ALLoc<ch0>:CCODing:NSF?

Queries the number of NPDSCH subframes (N_{SF}).

Return values:

<NumSF> integer
Range: 1 to 100
*RST: 1

Example: See [Example "NPDCCH and NPDSCH DCI-based configuration \(DCI format N1\)"](#) on page 803.

Usage: Query only

Manual operation: See ["Number of NPDSCH Subframes \(\$N_{SF}\$ \)"](#) on page 405

[:SOURce<hw>]:BB:EUTRa:DL:NIOT:ALLoc<ch0>:CCODing:TBSI <TBSindex>

Sets the transport block size index.

Parameters:

<TBSindex> integer
Range: 0 to 15
*RST: 0

Example: See [Example "NPDCCH and NPDSCH DCI-based configuration \(DCI format N1\)"](#) on page 803.

Manual operation: See ["Transport Block Size Index \(\$I_{TBS}\$ \)"](#) on page 405

[:SOURce<hw>]:BB:EUTRa:DL:NIOT:ALLoc<ch0>:CCODing:TBSize?

Queries the size of the transport block/payload in bits.

Return values:

<TranBlckSize> integer
Range: 16 to 1500
*RST: 16

Example: See [Example "NPBCH and SIB1-NB configuration"](#) on page 807.

Usage: Query only

Manual operation: See ["Transport Block Size/Payload \(DL\)"](#) on page 402
See ["Transport Block Size/Payload \(DL\)"](#) on page 405

[:SOURce<hw>]:BB:EUTRa:DL:NIOT:CCODing:MIB <MibState>

Enables transmission of MIB data.

Parameters:

<MibState> 1 | ON | 0 | OFF
*RST: 1

Example: See [Example"NPBCH and SIB1-NB configuration"](#) on page 807.

Manual operation: See ["MIB \(including SFN\)"](#) on page 400

[:SOURCE<hw>]:BB:EUTRa:DL:NIOT:CCODing:MSPare <MibSpareBits>

Sets the 11 spare bits in the NPBCH transmission.

Parameters:

<MibSpareBits> 11-bits

Example: See [Example"NPBCH and SIB1-NB configuration"](#) on page 807.

Manual operation: See ["MIB Spare Bits"](#) on page 402

[:SOURCE<hw>]:BB:EUTRa:DL:NIOT:CCODing:NCID?

Queries the NCell ID.

Return values:

<NCellId> integer
Range: 0 to 503

Example: See [Example"NPBCH and SIB1-NB configuration"](#) on page 807.

Usage: Query only

Manual operation: See ["NCell ID"](#) on page 401

[:SOURCE<hw>]:BB:EUTRa:DL:NIOT:CCODing:RSIB?

Queries the number of repetitions of the NDPSCCH that carries SIB1-NB.

Return values:

<RepetitionSIB1> integer
Range: 0 to 16
*RST: 0

Example: See [Example"NPBCH and SIB1-NB configuration"](#) on page 807.

Usage: Query only

Manual operation: See ["NPDSCH repetition carrying SIB1"](#) on page 401

[:SOURCE<hw>]:BB:EUTRa:DL:NIOT:CCODing:SIB <SchedulingSIB1>

Sets the parameter scheduling info SIB1.

Parameters:

<SchedulingSIB1> integer
Range: 0 to 15
*RST: 0

Example: See [Example"NPBCH and SIB1-NB configuration"](#) on page 807.

Manual operation: See ["Scheduling SIB1"](#) on page 400

[:SOURCE<hw>]:BB:EUTRa:DL:NIOT:CCODing:SOFFset <SfnOffset>

Sets the start SFN value.

Parameters:

<SfnOffset> float
 Range: 0 to 1020
 Increment: 4
 *RST: 0

Example: See [Example"NPBCH and SIB1-NB configuration"](#) on page 807.

Manual operation: See ["SFN Offset"](#) on page 400

[:SOURCE<hw>]:BB:EUTRa:DL:NIOT:CCODing:STFSib1?

Queries the first frame in that the NPDSCH transmission carrying SIB1-NB is allocated.

Return values:

<SIB1StartFrame> integer
 Range: 0 to 11
 *RST: 0

Example: See [Example"NPBCH and SIB1-NB configuration"](#) on page 807.

Usage: Query only

Manual operation: See ["Starting Frame carrying SIB1"](#) on page 401

10.27.2.4 NB-LoT user configuration

[:SOURCE<hw>]:BB:EUTRa:DL:USER<ch>:RELease	863
[:SOURCE<hw>]:BB:EUTRa:DL:USER<ch>:NIOT:RMAX	864
[:SOURCE<hw>]:BB:EUTRa:DL:USER<ch>:NIOT:STSFrame	864
[:SOURCE<hw>]:BB:EUTRa:DL:USER<ch>:NIOT:SSOFFset	864

[:SOURCE<hw>]:BB:EUTRa:DL:USER<ch>:RELease <Release>

Sets the 3GPP release version the UE supports.

Parameters:

<Release> R89 | LADV | EM_A | NIOT | EM_B
 *RST: R89 (in LTE/eMTC/NB-LoT mode)/
 EM_A (in eMTC/NB-LoT mode)
 EM_A = eMTC CE: A and EM_B = eMTC CE: B

Options: R89 requires R&S SMM-K55
 LADV requires R&S SMM-K85
 EM_A|NIOT|EM_B require R&S SMM-K115

Manual operation: See ["3GPP Release"](#) on page 132

[:SOURce<hw>]:BB:EUTRa:DL:USER<ch>:NIOT:RMAX <MaxRepNPDCCH>

Sets the maximum number NPDCCH is repeated R_{Max} .

Parameters:

<MaxRepNPDCCH> R1 | R2 | R4 | R8 | R16 | R32 | R64 | R128 | R256 | R512 |
R1024 | R2048
*RST: R1

Example: See [Example "NB-LoT UE configuration"](#) on page 802.

Manual operation: See ["Max. Repetitions of NPDCCH \(Rmax\) \(UE-specific search space\)"](#) on page 379

[:SOURce<hw>]:BB:EUTRa:DL:USER<ch>:NIOT:STSFrame <SearchSpStartSF>

Sets the search space start subframe (G).

Parameters:

<SearchSpStartSF> S1_5 | S2 | S4 | S8 | S16 | S32 | S48 | S64
*RST: S4

Example: See [Example "NB-LoT UE configuration"](#) on page 802.

Manual operation: See ["Search Space Start Subframe \(G\)"](#) on page 379

[:SOURce<hw>]:BB:EUTRa:DL:USER<ch>:NIOT:SSOffset <SearchSpaceOffs>

Shifts the search space start.

Parameters:

<SearchSpaceOffs> O0 | O1_8 | O1_4 | O3_8
*RST: O0

Example: See [Example "NB-LoT UE configuration"](#) on page 802.

Manual operation: See ["Search Space Offset \(\$\alpha_{offset}\$ \)"](#) on page 379

10.27.2.5 eMTC DCI configuration

[:SOURce<hw>]:BB:EUTRa:DL:EMTC:DCI:NALLoc.....	865
[:SOURce<hw>]:BB:EUTRa:DL:EMTC:DCI:AWARound.....	865
[:SOURce<hw>]:BB:EUTRa:DL:EMTC:DCI:ALLoc<ch0>:USER.....	866
[:SOURce<hw>]:BB:EUTRa:DL:EMTC:DCI:ALLoc<ch0>:UEID?.....	866
[:SOURce<hw>]:BB:EUTRa:DL:EMTC:DCI:ALLoc<ch0>:MPDCchset.....	866
[:SOURce<hw>]:BB:EUTRa:DL:EMTC:DCI:ALLoc<ch0>:FMT.....	867
[:SOURce<hw>]:BB:EUTRa:DL:EMTC:DCI:ALLoc<ch0>:SSP.....	867
[:SOURce<hw>]:BB:EUTRa:DL:EMTC:DCI:ALLoc<ch0>:STSFrame.....	867
[:SOURce<hw>]:BB:EUTRa:DL:EMTC:DCI:ALLoc<ch0>:PDCCh.....	867
[:SOURce<hw>]:BB:EUTRa:DL:EMTC:DCI:ALLoc<ch0>:CCES?.....	868
[:SOURce<hw>]:BB:EUTRa:DL:EMTC:DCI:ALLoc<ch0>:IDCCe.....	868
[:SOURce<hw>]:BB:EUTRa:DL:EMTC:DCI:ALLoc<ch0>:BITS?.....	868

[SOURce<hw>]:BB:EUTRa:DL:EMTC:DCI:ALLoc<ch0>:NDCCes?	868
[SOURce<hw>]:BB:EUTRa:DL:EMTC:DCI:ALLoc<ch0>:CONFLict?	869
[SOURce<hw>]:BB:EUTRa:DL:EMTC:DCI:ALLoc<ch0>:TBS?	869
[SOURce<hw>]:BB:EUTRa:DL:EMTC:DCI:ALLoc<ch0>:REPMpdccch?	869
[SOURce<hw>]:BB:EUTRa:DL:EMTC:DCI:ALLoc<ch0>:REPPdsch?	870
[SOURce<hw>]:BB:EUTRa:DL:EMTC:DCI:ALLoc<ch0>:PDSHopping?	870
[SOURce<hw>]:BB:EUTRa:DL:EMTC:DCI:ALLoc<ch0>:STRV?	870
[SOURce<hw>]:BB:EUTRa:DL:EMTC:DCI:ALLoc<ch0>:TCMD	870
[SOURce<hw>]:BB:EUTRa:DL:EMTC:DCI:ALLoc<ch0>:PFRHopp	871
[SOURce<hw>]:BB:EUTRa:DL:EMTC:DCI:ALLoc<ch0>:RBAF?	871
[SOURce<hw>]:BB:EUTRa:DL:EMTC:DCI:ALLoc<ch0>:RBA	871
[SOURce<hw>]:BB:EUTRa:DL:EMTC:DCI:ALLoc<ch0>:MCS	871
[SOURce<hw>]:BB:EUTRa:DL:EMTC:DCI:ALLoc<ch0>:NREP	872
[SOURce<hw>]:BB:EUTRa:DL:EMTC:DCI:ALLoc<ch0>:HARQ	872
[SOURce<hw>]:BB:EUTRa:DL:EMTC:DCI:ALLoc<ch0>:NDINd	872
[SOURce<hw>]:BB:EUTRa:DL:EMTC:DCI:ALLoc<ch0>:RVER	872
[SOURce<hw>]:BB:EUTRa:DL:EMTC:DCI:ALLoc<ch0>:TPCPusch	873
[SOURce<hw>]:BB:EUTRa:DL:EMTC:DCI:ALLoc<ch0>:ULINdex	873
[SOURce<hw>]:BB:EUTRa:DL:EMTC:DCI:ALLoc<ch0>:DAINdex	873
[SOURce<hw>]:BB:EUTRa:DL:EMTC:DCI:ALLoc<ch0>:CSIRequest	874
[SOURce<hw>]:BB:EUTRa:DL:EMTC:DCI:ALLoc<ch0>:SRSRequest	874
[SOURce<hw>]:BB:EUTRa:DL:EMTC:DCI:ALLoc<ch0>:SFRNumber	874
[SOURce<hw>]:BB:EUTRa:DL:EMTC:DCI:ALLoc<ch0>:UEMode	874
[SOURce<hw>]:BB:EUTRa:DL:EMTC:DCI:ALLoc<ch0>:HRESoffset	875
[SOURce<hw>]:BB:EUTRa:DL:EMTC:DCI:ALLoc<ch0>:APSI	875
[SOURce<hw>]:BB:EUTRa:DL:EMTC:DCI:ALLoc<ch0>:PMIConfirm	875
[SOURce<hw>]:BB:EUTRa:DL:EMTC:DCI:ALLoc<ch0>:TPMPrec	875
[SOURce<hw>]:BB:EUTRa:DL:EMTC:DCI:ALLoc<ch0>:PRAPreamble	876
[SOURce<hw>]:BB:EUTRa:DL:EMTC:DCI:ALLoc<ch0>:PRAMask	876
[SOURce<hw>]:BB:EUTRa:DL:EMTC:DCI:ALLoc<ch0>:PRASStart	876
[SOURce<hw>]:BB:EUTRa:DL:EMTC:DCI:ALLoc<ch0>:PAGNg	876
[SOURce<hw>]:BB:EUTRa:DL:EMTC:DCI:ALLoc<ch0>:DIINfo	877

[SOURce<hw>]:BB:EUTRa:DL:EMTC:DCI:NALLoc <DciNumberAlloc>

Sets the number of configurable DCIs.

Parameters:

<DciNumberAlloc> integer
 Range: 0 to 400
 *RST: 0

Example: See [Example "MPDCCH and PDSCH DCI-based configuration \(DCI format 6-1A\)"](#) on page 816.

Manual operation: See ["Number of DCI Allocations"](#) on page 434

[SOURce<hw>]:BB:EUTRa:DL:EMTC:DCI:AWARound <AllocWrapAround>

If enabled, the PDSCH allocations are relocated at the beginning of the ARB sequence to ensure a consistent signal.

Parameters:

<AllocWrapAround> 1 | ON | 0 | OFF
 *RST: 0

Example:

SOURce1:BB:EUTRa:DL:EMTC:DCI:AWARound 1

[:SOURce<hw>]:BB:EUTRa:DL:EMTC:DCI:ALLoc<ch0>:USER <DciUser>

Selects the user the DCI is dedicated to.

Parameters:

<DciUser> USER1 | USER2 | USER3 | USER4 | PRNTi | RARNti
USER1|USER2|USER3|USER4
 Available are only eMTC users ([:SOURce<hw>]:BB:EUTRa:DL:USER<ch>:RELease EM_A|EM_B).
PRNTi|RARNti
 Selects a group of users.
 *RST: USER1

Example: See [Example"DCI format 6-2 configuration"](#) on page 820.

Manual operation: See ["User"](#) on page 434

[:SOURce<hw>]:BB:EUTRa:DL:EMTC:DCI:ALLoc<ch0>:UEID?

Queries the UE_ID of the selected user or the n_RNTI for the selected DCI.

Return values:

<DciUeID> integer
 Range: 0 to 65535
 *RST: 0

Example: See [Example"MPDCCH and PDSCH DCI-based configuration \(DCI format 6-1A\)"](#) on page 816.

Usage: Query only

Manual operation: See ["UE_ID/n_RNTI"](#) on page 435

[:SOURce<hw>]:BB:EUTRa:DL:EMTC:DCI:ALLoc<ch0>:MPDCchset <DciMpdccSet>

Selects the MPDCCH set by which the DCI is carried.

Parameters:

<DciMpdccSet> MPD1 | MPD2
 *RST: MPD1

Example: See [Example"MPDCCH and PDSCH DCI-based configuration \(DCI format 6-1A\)"](#) on page 816.

Manual operation: See ["MPDCCH Set"](#) on page 435

[:SOURce<hw>]:BB:EUTRa:DL:EMTC:DCI:ALLoc<ch0>:FMT <DciFormat>

Sets the DCI format for the selected allocation.

Parameters:

<DciFormat> F3 | F3A | F60A | F60B | F61A | F61B | F62
 *RST: F60A

Example: See [Example"MPDCCH and PDSCH DCI-based configuration \(DCI format 6-1A\)"](#) on page 816.

Manual operation: See ["DCI Format"](#) on page 435

[:SOURce<hw>]:BB:EUTRa:DL:EMTC:DCI:ALLoc<ch0>:SSP <DciSearchSpace>

Sets the search space for the selected DCI.

Parameters:

<DciSearchSpace> UE | T1CM | T2CM | T0CM
 *RST: UE

Example: See [Example"MPDCCH and PDSCH DCI-based configuration \(DCI format 6-1A\)"](#) on page 816.

Manual operation: See ["Search Space"](#) on page 435

[:SOURce<hw>]:BB:EUTRa:DL:EMTC:DCI:ALLoc<ch0>:STSFrame <DciStartSf>

Sets the next valid starting subframe for the particular MPDCCH.

Parameters:

<DciStartSf> integer
 Range: 1 to 1E6
 *RST: 1

Example: See [Example"MPDCCH and PDSCH DCI-based configuration \(DCI format 6-1A\)"](#) on page 816.

Manual operation: See ["Start Subframe"](#) on page 443

[:SOURce<hw>]:BB:EUTRa:DL:EMTC:DCI:ALLoc<ch0>:PDCCh <DciPdcchFmt>

Selects one of the five MPDCCH formats

Parameters:

<DciPdcchFmt> 0 | 1 | 2 | 3 | 4 | 5
 The available values depend on the search space.
 *RST: 0

Example: See [Example"MPDCCH and PDSCH DCI-based configuration \(DCI format 6-1A\)"](#) on page 816.

Manual operation: See ["MPDCCH Format"](#) on page 444

[:SOURce<hw>]:BB:EUTRa:DL:EMTC:DCI:ALLoc<ch0>:CCES?

Queries the number of consecutive control channel elements (ECCE) on that MPDCCH is transmitted.

Return values:

<DciNumCCEs> integer
 Range: 1 to 24
 *RST: 1

Example: See [Example"MPDCCH and PDSCH DCI-based configuration \(DCI format 6-1A\)"](#) on page 816.

Usage: Query only

Manual operation: See ["Number ECCEs"](#) on page 444

[:SOURce<hw>]:BB:EUTRa:DL:EMTC:DCI:ALLoc<ch0>:IDCCe <DciCCEIndex>

For UE-specific search space, sets the ECCE start index.

Parameters:

<DciCCEIndex> integer
 Range: 0 to 24
 *RST: 0

Example: See [Example"MPDCCH and PDSCH DCI-based configuration \(DCI format 6-1A\)"](#) on page 816.

Manual operation: See ["ECCE Index"](#) on page 444

[:SOURce<hw>]:BB:EUTRa:DL:EMTC:DCI:ALLoc<ch0>:BITS?

Queries the resulting bit data as selected with the DCI format parameters.

Return values:

<DciBitData> string

Example: See [Example"MPDCCH and PDSCH DCI-based configuration \(DCI format 6-1A\)"](#) on page 816.

Usage: Query only

Manual operation: See ["Bit Data"](#) on page 436

[:SOURce<hw>]:BB:EUTRa:DL:EMTC:DCI:ALLoc<ch0>:NDCCes?

Queries the number of dummy ECCEs that are appended to the corresponding MPDCCH.

Return values:

<NoDummyCCEs> integer
 Range: 0 to 1E5
 *RST: 25

Example: See [Example"MPDCCH and PDSCH DCI-based configuration \(DCI format 6-1A\)"](#) on page 816.

Usage: Query only

Manual operation: See ["No. Dummy ECCEs"](#) on page 444

[:SOURCE<hw>]:BB:EUTRa:DL:EMTC:DCI:ALLoc<ch0>:CONFLict?

Queries whether a conflict between allocations occurs.

Return values:

<Conflict> 1 | ON | 0 | OFF
*RST: 0

Example: SOURCE1:BB:EUTRa:DL:EMTC:DCI:ALLoc2:CONFLict?
// 0

Usage: Query only

Manual operation: See ["Conflict"](#) on page 444

[:SOURCE<hw>]:BB:EUTRa:DL:EMTC:DCI:ALLoc<ch0>:TBS?

Queries the resulting transport block size.

Return values:

<DciTranBlkSize> integer
Range: 0 to 2000
*RST: 0

Example: See [Example"MPDCCH and PDSCH DCI-based configuration \(DCI format 6-1A\)"](#) on page 816.

Usage: Query only

Manual operation: See ["Transport Block Size"](#) on page 443

[:SOURCE<hw>]:BB:EUTRa:DL:EMTC:DCI:ALLoc<ch0>:REPMpdccH?

Queries the resulting number of MPDCCH repetitions.

Return values:

<DciRepMPDCCH> integer
Range: 1 to 256
*RST: 0

Example: See [Example"MPDCCH and PDSCH DCI-based configuration \(DCI format 6-1A\)"](#) on page 816.

Usage: Query only

Manual operation: See ["Repetitions of MPDCCH"](#) on page 443

[[:SOURce<hw>]:BB:EUTRa:DL:EMTC:DCI:ALLoc<ch0>:REPPdsch?

Queries the resulting number of PDSCH repetitions.

Return values:

<DciRepPDSCH> integer
Range: 1 to 2048
*RST: 0

Example: See [Example"MPDCCH and PDSCH DCI-based configuration \(DCI format 6-1A\)"](#) on page 816.

Usage: Query only

Manual operation: See ["Repetitions of PDSCH"](#) on page 443

[[:SOURce<hw>]:BB:EUTRa:DL:EMTC:DCI:ALLoc<ch0>:PDSHopping?

Queries if PDSCH hopping is enabled or not.

Return values:

<DciPDSCHHopping> 1 | ON | 0 | OFF
*RST: 0

Example: See [Example"MPDCCH and PDSCH DCI-based configuration \(DCI format 6-1A\)"](#) on page 816.

Usage: Query only

Manual operation: See ["PDSCH Hopping"](#) on page 443

[[:SOURce<hw>]:BB:EUTRa:DL:EMTC:DCI:ALLoc<ch0>:STRV?

Queries the starting redundancy version (RV).

Return values:

<DciStartingRV> integer
Range: 0 to 3
*RST: 0

Example: See [Example"MPDCCH and PDSCH DCI-based configuration \(DCI format 6-1A\)"](#) on page 816.

Usage: Query only

Manual operation: See ["Starting Redundancy Version"](#) on page 443

[[:SOURce<hw>]:BB:EUTRa:DL:EMTC:DCI:ALLoc<ch0>:TCMD <TpcCmd3>

Sets the TCP command field of the DCI format 3/3A.

Parameters:

<TpcCmd3> 64 bits

Example: SOURCE1:BB:EUTRa:DL:EMTC:DCI:ALLoc0:FMT F3
SOURCE1:BB:EUTRa:DL:EMTC:DCI:ALLoc0:TCMD #H0,64

Manual operation: See ["DCI Format 3/3A"](#) on page 436

[:SOURCE<hw>]:BB:EUTRa:DL:EMTC:DCI:ALLoc<ch0>:PFRHopp
<DciPuschFreqHop>

Sets the DCI format 6-0A and 6-1A filed frequency hopping flag that applies to PUSCH and PDSCH respectively.

Parameters:

<DciPuschFreqHop> 1 | ON | 0 | OFF
*RST: 0

Example: See [Example"MPDCCH and PDSCH DCI-based configuration \(DCI format 6-1A\)"](#) on page 816.

[:SOURCE<hw>]:BB:EUTRa:DL:EMTC:DCI:ALLoc<ch0>:RBAF?

If [:SOURCE<hw>] :BB:EUTRa:DL:BW on page 584 BW20_00 and [:SOURCE<hw>] :BB:EUTRa:DL:EMTC:WBCFg on page 823 BW20 sets the DCI format 6-1A field resource block assignment index.

Return values:

<DciPuschRBAF> 1 | ON | 0 | OFF
*RST: 0

Example: SOURCE1:BB:EUTRa:DL:EMTC:DCI:ALLoc1:RBAF 1

Usage: Query only

Options: R&S SMM-K143

[:SOURCE<hw>]:BB:EUTRa:DL:EMTC:DCI:ALLoc<ch0>:RBA <DciRBA>

Sets the DCI filed resource block assignment.

Parameters:

<DciRBA> integer
Range: 0 to depends on the installed options*
*RST: 0
max = 2047 (R&S SMM-K115)
max = 4095 (R&S SMM-K143)

Example: See [Example"MPDCCH and PDSCH DCI-based configuration \(DCI format 6-1A\)"](#) on page 816.

[:SOURCE<hw>]:BB:EUTRa:DL:EMTC:DCI:ALLoc<ch0>:MCS <DciMCS>

Sets the DCI field modulation and coding scheme.

Parameters:

<DciMCS> integer
 Range: 0 to 15
 *RST: 0

Example: See [Example"MPDCCH and PDSCH DCI-based configuration \(DCI format 6-1A\)"](#) on page 816.

[:SOURCE<hw>]:BB:EUTRa:DL:EMTC:DCI:ALLoc<ch0>:NREP <DciRepNum>

Sets the DCI field repetition number.

Parameters:

<DciRepNum> integer
 Range: 0 to 3
 *RST: 0

Example: See [Example"MPDCCH and PDSCH DCI-based configuration \(DCI format 6-1A\)"](#) on page 816.

[:SOURCE<hw>]:BB:EUTRa:DL:EMTC:DCI:ALLoc<ch0>:HARQ
 <DciHarqProcNum>

Sets the DCI field HARQ process number.

Parameters:

<DciHarqProcNum> integer
 In FDD mode: 0 to 7
 In TDD mode: 0 to 15
 Range: 0 to 15
 *RST: 0

Example: See [Example"MPDCCH and PDSCH DCI-based configuration \(DCI format 6-1A\)"](#) on page 816.

[:SOURCE<hw>]:BB:EUTRa:DL:EMTC:DCI:ALLoc<ch0>:NDIND <DciNewDataInd>

Sets the DCI field new data indicator.

Parameters:

<DciNewDataInd> 1 | ON | 0 | OFF
 *RST: 0

Example: See [Example"MPDCCH and PDSCH DCI-based configuration \(DCI format 6-1A\)"](#) on page 816.

[:SOURCE<hw>]:BB:EUTRa:DL:EMTC:DCI:ALLoc<ch0>:RVER <DciRedVersion>

Sets the DCI field redundancy version.

Parameters:

<DciRedVersion> integer
 Range: 0 to 3
 *RST: 0

Example: See [Example"MPDCCH and PDSCH DCI-based configuration \(DCI format 6-1A\)"](#) on page 816.

[:SOURce<hw>]:BB:EUTRa:DL:EMTC:DCI:ALLoc<ch0>:TPCPusch
 <DciTpcCmdPusch>

Sets the DCI field TPC command for scheduled PUSCH.

Parameters:

<DciTpcCmdPusch> integer
 Range: 0 to 3
 *RST: 0

Example: See [Example"MPDCCH and PDSCH DCI-based configuration \(DCI format 6-1A\)"](#) on page 816.

[:SOURce<hw>]:BB:EUTRa:DL:EMTC:DCI:ALLoc<ch0>:ULIndex <DciUlIndex>

In TDD mode and if UL/DL Configuration 0 is used, sets the DCI field UL index.

Parameters:

<DciUlIndex> integer
 Range: 0 to 3
 *RST: 0

Example:

```
SOURce1:BB:EUTRa:DUPLexing TDD
SOURce1:BB:EUTRa:TDD:UDConf 0
SOURce1:BB:EUTRa:DL:EMTC:DCI:ALLoc0:FMT F60A
SOURce1:BB:EUTRa:DL:EMTC:DCI:ALLoc0:ULIndex 1
SOURce1:BB:EUTRa:DL:EMTC:DCI:ALLoc0:DAIndex 1
```

[:SOURce<hw>]:BB:EUTRa:DL:EMTC:DCI:ALLoc<ch0>:DAIndex
 <DLAssignIndex>

In TDD mode and if UL/DL Configuration 0 is used, sets the DCI field downlink assignment index (DAI).

Parameters:

<DLAssignIndex> integer
 Range: 0 to 3
 *RST: 0

Example: See [\[:SOURce<hw>\]:BB:EUTRa:DL:EMTC:DCI:ALLoc<ch0>:ULIndex](#) on page 873.

[:SOURce<hw>]:BB:EUTRa:DL:EMTC:DCI:ALLoc<ch0>:CSIRequest
 <DciCSIRequest>

Sets the DCI field CSI request.

Parameters:

<DciCSIRequest> 1 | ON | 0 | OFF
 *RST: 0

Example: See [Example"MPDCCH and PDSCH DCI-based configuration \(DCI format 6-1A\)"](#) on page 816.

[:SOURce<hw>]:BB:EUTRa:DL:EMTC:DCI:ALLoc<ch0>:SRSRequest
 <DciSRSRequest>

Sets the DCI field SRS request.

Parameters:

<DciSRSRequest> 1 | ON | 0 | OFF
 *RST: 0

Example: See [Example"MPDCCH and PDSCH DCI-based configuration \(DCI format 6-1A\)"](#) on page 816.

[:SOURce<hw>]:BB:EUTRa:DL:EMTC:DCI:ALLoc<ch0>:SFRNumber
 <DciSfRepNumber>

If [:SOURce<hw>]:BB:EUTRa:DL:USER<ch>:EPDCch:CELL<st0>:SET<dir>:REPmpdcch ≥ 2, sets the DCI field DCI subframe repetition number.

Parameters:

<DciSfRepNumber> integer
 Range: 0 to 3
 *RST: 0

Example: See [Example"MPDCCH and PDSCH DCI-based configuration \(DCI format 6-1A\)"](#) on page 816.

[:SOURce<hw>]:BB:EUTRa:DL:EMTC:DCI:ALLoc<ch0>:UEMode <UEMode>

Sets the DCI field mode and defines if the DCI format 6-1A/B is used for PDSCH or PRACH.

Parameters:

<UEMode> STD | PRACH
 *RST: STD

Example: See [Example"MPDCCH and PDSCH DCI-based configuration \(DCI format 6-1A\)"](#) on page 816.

[:SOURCE<hw>]:BB:EUTRa:DL:EMTC:DCI:ALLoc<ch0>:HRESoffset
 <DciHarqResOffs>

Sets the DCI field HARQ-ACK resource offset.

Parameters:

<DciHarqResOffs> integer
 Range: 0 to 3
 *RST: 0

Example: See [Example"MPDCCH and PDSCH DCI-based configuration \(DCI format 6-1A\)"](#) on page 816.

[:SOURCE<hw>]:BB:EUTRa:DL:EMTC:DCI:ALLoc<ch0>:APSI <DciAPsSI>

For users working in transmission mode TM9 and if UE-specific search space is used, sets the DCI format 6-1A field antenna ports and scrambling identity.

Parameters:

<DciAPsSI> integer
 Range: 0 to 3
 *RST: 0

Example:

```
SOURCE1:BB:EUTRa:DL:USER1:TXM TM9
SOURCE1:BB:EUTRa:DL:EMTC:DCI:ALLoc0:FMT F61A
SOURCE1:BB:EUTRa:DL:EMTC:DCI:ALLoc0:APSI 1
```

[:SOURCE<hw>]:BB:EUTRa:DL:EMTC:DCI:ALLoc<ch0>:PMIConfirm
 <DciPmiConfirm>

Sets the DCI field PMI confirmation for precoding.

Parameters:

<DciPmiConfirm> 1 | ON | 0 | OFF
 *RST: 0

Example: See [Example"MPDCCH and PDSCH DCI-based configuration \(DCI format 6-1A\)"](#) on page 816.

[:SOURCE<hw>]:BB:EUTRa:DL:EMTC:DCI:ALLoc<ch0>:TPMPrec <DciTpmiPrec>

Sets the DCI field TPMI information for precoding.

Parameters:

<DciTpmiPrec> integer
 Range: 0 to 15
 *RST: 0

Example: See [Example"MPDCCH and PDSCH DCI-based configuration \(DCI format 6-1A\)"](#) on page 816.

[:SOURCE<hw>]:BB:EUTRa:DL:EMTC:DCI:ALLoc<ch0>:PRAPreamble
 <DciPrachPreambl>

Sets the DCI field preamble index.

Parameters:

<DciPrachPreambl> integer
 Range: 0 to 63
 *RST: 0

Example:

```
SOURce1:BB:EUTRa:DL:EMTC:DCI:ALLoc0:FMT F61A
SOURce1:BB:EUTRa:DL:EMTC:DCI:ALLoc0:UEMode PRACH
SOURce1:BB:EUTRa:DL:EMTC:DCI:ALLoc0:RBA 1
SOURce1:BB:EUTRa:DL:EMTC:DCI:ALLoc0:PRAPreamble 8
SOURce1:BB:EUTRa:DL:EMTC:DCI:ALLoc0:PRAMask 5
SOURce1:BB:EUTRa:DL:EMTC:DCI:ALLoc0:PRASStart 1
```

[:SOURCE<hw>]:BB:EUTRa:DL:EMTC:DCI:ALLoc<ch0>:PRAMask
 <DciPrachMaskIdx>

Sets the DCI field PRACH mask index.

Parameters:

<DciPrachMaskIdx> integer
 Range: 0 to 15
 *RST: 0

Example:

See [:SOURCE<hw>]:BB:EUTRa:DL:EMTC:DCI:ALLoc<ch0>:PRAPreamble on page 876.

[:SOURCE<hw>]:BB:EUTRa:DL:EMTC:DCI:ALLoc<ch0>:PRASStart
 <DciPrachStartCe>

Sets the DCI field starting CE level.

Parameters:

<DciPrachStartCe> integer
 Range: 0 to 3
 *RST: 0

Example:

See [:SOURCE<hw>]:BB:EUTRa:DL:EMTC:DCI:ALLoc<ch0>:PRAPreamble on page 876.

[:SOURCE<hw>]:BB:EUTRa:DL:EMTC:DCI:ALLoc<ch0>:PAGNg <DciPaging>

Sets the DCI bit that defines if the DCI format 6-2 is used for paging or for direct indication.

Parameters:

<DciPaging> 1 | ON | 0 | OFF
 *RST: 0

Firmware/software: See [Example"DCI format 6-2 configuration"](#) on page 820.

[:SOURce<hw>]:BB:EUTRa:DL:EMTC:DCI:ALLoc<ch0>:DIInfo <DciDiInfo>

Sets the DCI field direct indication information.

Parameters:

<DciDiInfo> integer
 Range: 0 to 255
 *RST: 0

Example: See [Example"DCI format 6-2 configuration"](#) on page 820 .

10.27.2.6 eMTC allocations

[:SOURce<hw>]:BB:EUTRa:DL:EMTC:NALLoc?	877
[:SOURce<hw>]:BB:EUTRa:DL:EMTC:ALLoc<ch0>:CONType?	877
[:SOURce<hw>]:BB:EUTRa:DL:EMTC:ALLoc<ch0>:MODulation?	878
[:SOURce<hw>]:BB:EUTRa:DL:EMTC:ALLoc<ch0>:STSFframe?	878
[:SOURce<hw>]:BB:EUTRa:DL:EMTC:ALLoc<ch0>:ABSFrames?	878
[:SOURce<hw>]:BB:EUTRa:DL:EMTC:ALLoc<ch0>:STNB?	879
[:SOURce<hw>]:BB:EUTRa:DL:EMTC:ALLoc<ch0>:STSYmbol?	879
[:SOURce<hw>]:BB:EUTRa:DL:EMTC:ALLoc<ch0>:NORB?	879
[:SOURce<hw>]:BB:EUTRa:DL:EMTC:ALLoc<ch0>:OVRB?	879
[:SOURce<hw>]:BB:EUTRa:DL:EMTC:ALLoc<ch0>:PHYSbits?	880
[:SOURce<hw>]:BB:EUTRa:DL:EMTC:ALLoc<ch0>:DATA	880
[:SOURce<hw>]:BB:EUTRa:DL:EMTC:ALLoc<ch0>:DSElect	880
[:SOURce<hw>]:BB:EUTRa:DL:EMTC:ALLoc<ch0>:PATtern	881
[:SOURce<hw>]:BB:EUTRa:DL:EMTC:ALLoc<ch0>:POWer	881
[:SOURce<hw>]:BB:EUTRa:DL:EMTC:ALLoc<ch0>:STATe?	881
[:SOURce<hw>]:BB:EUTRa:DL:EMTC:ALLoc<ch0>:CONFLict?	882

[:SOURce<hw>]:BB:EUTRa:DL:EMTC:NALLoc?

Queries the number of automatically configured allocations.

Return values:

<NoAlloc> integer
 Range: 0 to 100
 *RST: 1

Example: See [Example"MPDCCH and PDSCH DCI-based configuration \(DCI format 6-1A\)"](#) on page 816.

Usage: Query only

[:SOURce<hw>]:BB:EUTRa:DL:EMTC:ALLoc<ch0>:CONType?

Queries the channel type.

Return values:

<ContentType> MPD1 | MPD2 | PSIB | PDSCh | PBCH
 *RST: PDSCh

Example: See [Example"MPDCCH and PDSCH DCI-based configuration \(DCI format 6-1A\)"](#) on page 816.

Usage: Query only

Manual operation: See ["Content Type"](#) on page 445

[:SOURCE<hw>]:BB:EUTRa:DL:EMTC:ALLoc<ch0>:MODulation?

Queries the used modulation scheme.

Return values:

<Modulation> QAM16 | QPSK
 *RST: QPSK

Example: See [Example"MPDCCH and PDSCH DCI-based configuration \(DCI format 6-1A\)"](#) on page 816.

Usage: Query only

Manual operation: See ["Modulation"](#) on page 446

[:SOURCE<hw>]:BB:EUTRa:DL:EMTC:ALLoc<ch0>:STSFrame?

Queries the first subframe where the channel can be allocated.

Return values:

<StartSf> integer
 Range: 0 to 39
 *RST: 0

Example: See [Example"MPDCCH and PDSCH DCI-based configuration \(DCI format 6-1A\)"](#) on page 816.

Usage: Query only

Manual operation: See ["Start SF"](#) on page 446

[:SOURCE<hw>]:BB:EUTRa:DL:EMTC:ALLoc<ch0>:ABSFrames?

Queries the number of absolute subframes.

Return values:

<NumAbsSf> integer
 Range: 0 to 39
 *RST: 0

Example: See [Example"MPDCCH and PDSCH DCI-based configuration \(DCI format 6-1A\)"](#) on page 816.

Usage: Query only
Manual operation: See ["Num. Abs. SF"](#) on page 447

[:SOURCE<hw>]:BB:EUTRa:DL:EMTC:ALLoc<ch0>:STNB?

Queries the first narrowband where the channel can be allocated.

Return values:

<StartNarrowBand> integer
 Range: 0 to 15
 *RST: 0

Example: See [Example"MPDCCH and PDSCH DCI-based configuration \(DCI format 6-1A\)"](#) on page 816.

Usage: Query only
Manual operation: See ["Start NB"](#) on page 447

[:SOURCE<hw>]:BB:EUTRa:DL:EMTC:ALLoc<ch0>:STSYmbol?

Queries the first symbol where the channel can be allocated.

Return values:

<StartSymbol> 1 | 2 | 3 | 4
 *RST: 1

Example: See [Example"MPDCCH and PDSCH DCI-based configuration \(DCI format 6-1A\)"](#) on page 816.

Usage: Query only
Manual operation: See ["Start Symbol"](#) on page 447

[:SOURCE<hw>]:BB:EUTRa:DL:EMTC:ALLoc<ch0>:NORB?

Queries the number of resource blocks the allocation spans.

Return values:

<NumberResBlk> integer
 Range: 1 to 6
 *RST: 1

Example: See [Example"MPDCCH and PDSCH DCI-based configuration \(DCI format 6-1A\)"](#) on page 816.

Usage: Query only
Manual operation: See ["No. RB"](#) on page 447

[:SOURCE<hw>]:BB:EUTRa:DL:EMTC:ALLoc<ch0>:OVRB?

Queries the start resource block of the selected allocation.

Return values:

<OffsetVRB> integer
 Range: 0 to 5
 *RST: 0

Example: See [Example"MPDCCH and PDSCH DCI-based configuration \(DCI format 6-1A\)"](#) on page 816.

Usage: Query only

Manual operation: See ["Offset VRB"](#) on page 447

[:SOURCE<hw>]:BB:EUTRa:DL:EMTC:ALLOc<ch0>:PHYSbits?

Queries the allocation size in bits.

Return values:

<PhysBits> integer
 Range: 0 to 4032
 *RST: 0

Example: See [Example"MPDCCH and PDSCH DCI-based configuration \(DCI format 6-1A\)"](#) on page 816.

Usage: Query only

Manual operation: See ["Phys. Bits"](#) on page 447
 See ["Number of Physical Bits"](#) on page 451
 See ["Number of Physical Bits"](#) on page 457

[:SOURCE<hw>]:BB:EUTRa:DL:EMTC:ALLOc<ch0>:DATA <DataSource>

Queries the data source or sets the data source for the following allocations:

- PBCH if MIB is disabled
- PDSCH SIB1-BR allocation
- PDSCH allocations configured for P-RNTI or RA-RNTI.

Parameters:

<DataSource> USER1 | USER2 | USER3 | USER4 | PN9 | PN11 | PN15 |
 PN16 | PN20 | PN21 | PN23 | PATtern | DLISt | ZERO | ONE |
 MIB | PRNTi | RARNti | SIBBr
 *RST: MIB

Example: See [Example"MPDCCH and PDSCH DCI-based configuration \(DCI format 6-1A\)"](#) on page 816.

Manual operation: See ["Data Source"](#) on page 447

[:SOURCE<hw>]:BB:EUTRa:DL:EMTC:ALLOc<ch0>:DSElect <DataList>

Selects an existing data list file from the default directory or from the specific directory.

Parameters:

<DataList> string
 Filename incl. file extension or complete file path

Example:

See [Example"MPDCCH and PDSCH DCI-based configuration \(DCI format 6-1A\)"](#) on page 816.

```
SOURce1:BB:EUTRa:DL:EMTC:DCI:ALLoc0:USER PRNT
SOURce1:BB:EUTRa:DL:EMTC:ALLoc3:DATA DLIS
SOURce1:BB:EUTRa:DL:EMTC:ALLoc3:DSElect "/var/user/IoT.dm_igd"
```

Manual operation: See ["Data Source"](#) on page 447

[:SOURce<hw>]:BB:EUTRa:DL:EMTC:ALLoc<ch0>:PATtern <Pattern>, <BitCount>

Sets a bit pattern as data source.

Parameters:

<Pattern> numeric
 *RST: #H0

<BitCount> integer
 Range: 1 to 64
 *RST: 1

Example:

```
SOURce1:BB:EUTRa:DL:EMTC:DCI:ALLoc0:USER PRNT
SOURce1:BB:EUTRa:DL:EMTC:ALLoc3:DATA PATT
SOURce1:BB:EUTRa:DL:EMTC:ALLoc3:PATtern #H735,12
```

Manual operation: See ["Data Source"](#) on page 447

[:SOURce<hw>]:BB:EUTRa:DL:EMTC:ALLoc<ch0>:POWer <Power>

Sets the power of the selected allocation.

Parameters:

<Power> float
 Range: -80 to 10
 Increment: 0.01
 *RST: 0

Example:

See [Example"MPDCCH and PDSCH DCI-based configuration \(DCI format 6-1A\)"](#) on page 816.

Manual operation: See ["p A"](#) on page 448

[:SOURce<hw>]:BB:EUTRa:DL:EMTC:ALLoc<ch0>:STATe?

Queries whether the allocation is activated.

Return values:

<State> 1 | ON | 0 | OFF
 *RST: 0

Example: See [Example"MPDCCH and PDSCH DCI-based configuration \(DCI format 6-1A\)"](#) on page 816.

Usage: Query only

Manual operation: See ["State"](#) on page 448

[:SOURce<hw>]:BB:EUTRa:DL:EMTC:ALLoc<ch0>:CONFLICT?

Queries if there is a conflict between the allocations.

Return values:

<Conflict> 1 | ON | 0 | OFF
 *RST: 0

Example: See [Example"MPDCCH and PDSCH DCI-based configuration \(DCI format 6-1A\)"](#) on page 816.

Usage: Query only

Manual operation: See ["Conflict"](#) on page 448

10.27.2.7 PBCH and PDSCH enhanced settings

[:SOURce<hw>]:BB:EUTRa:DL:EMTC:ALLoc<ch0>:PRECoding:SCHEME.....	883
[:SOURce<hw>]:BB:EUTRa:DL:EMTC:ALLoc<ch0>:CODWords?.....	883
[:SOURce<hw>]:BB:EUTRa:DL:EMTC:ALLoc<ch0>:PRECoding:NOLayers?.....	883
[:SOURce<hw>]:BB:EUTRa:DL:EMTC:ALLoc<ch0>:PRECoding:CCD.....	884
[:SOURce<hw>]:BB:EUTRa:DL:EMTC:ALLoc<ch0>:PRECoding:CBIndex.....	884
[:SOURce<hw>]:BB:EUTRa:DL:EMTC:ALLoc<ch0>:PRECoding:TRScheme?.....	884
[:SOURce<hw>]:BB:EUTRa:DL:EMTC:ALLoc<ch0>:PRECoding:AP?.....	885
[:SOURce<hw>]:BB:EUTRa:DL:EMTC:ALLoc<ch0>:PRECoding:SCID?.....	886
[:SOURce<hw>]:BB:EUTRa:DL:EMTC:ALLoc<ch0>:PRECoding:APM?.....	886
[:SOURce<hw>]:BB:EUTRa:DL:EMTC:ALLoc<ch0>:PRECoding:DAFormat.....	886
[:SOURce<hw>]:BB:EUTRa:DL:EMTC:ALLoc<ch0>:PRECoding:AP<dir0>:BB<st0>: REAL?.....	886
[:SOURce<hw>]:BB:EUTRa:DL:EMTC:ALLoc<ch0>:PRECoding:AP<dir0>:BB<st0>: IMAGinary?.....	887
[:SOURce<hw>]:BB:EUTRa:DL:EMTC:ALLoc<ch0>:SCRambling:STATE.....	887
[:SOURce<hw>]:BB:EUTRa:DL:EMTC:ALLoc<ch0>:SCRambling:UEID?.....	888
[:SOURce<hw>]:BB:EUTRa:DL:EMTC:ALLoc<ch0>:CCODing:STATE.....	888
[:SOURce<hw>]:BB:EUTRa:DL:EMTC:ALLoc<ch0>:CCODing:TBSIZE?.....	888
[:SOURce<hw>]:BB:EUTRa:DL:EMTC:ALLoc<ch0>:CCODing:TBSI.....	889
[:SOURce<hw>]:BB:EUTRa:DL:EMTC:ALLoc<ch0>:CCODing:MIB.....	889
[:SOURce<hw>]:BB:EUTRa:DL:EMTC:ALLoc<ch0>:CCODing:SIB.....	889
[:SOURce<hw>]:BB:EUTRa:DL:EMTC:ALLoc<ch0>:CCODing:RSIB?.....	890

[:SOURce<hw>]:BB:EUTRa:DL:EMTC:ALLOc<ch0>:CCODing:MSPare.....890
 [:SOURce<hw>]:BB:EUTRa:DL:EMTC:ALLOc<ch0>:CCODing:SOFFset..... 890
 [:SOURce<hw>]:BB:EUTRa:DL:EMTC:ALLOc<ch0>:CCODing:SRPeriod..... 890

[:SOURce<hw>]:BB:EUTRa:DL:EMTC:ALLOc<ch0>:PRECoding:SCHEME
 <PrecMultAntSche>

Selects the precoding scheme.

Parameters:

<PrecMultAntSche> NONE | SPM | TXD | BF
 *RST: NONE

Example: See [Example"MPDCCH and PDSCH DCI-based configuration \(DCI format 6-1A\)"](#) on page 816.

Manual operation: See ["Precoding Scheme"](#) on page 450
 See ["Precoding Scheme"](#) on page 453

[:SOURce<hw>]:BB:EUTRa:DL:EMTC:ALLOc<ch0>:CODWords?

Queries the number of the codewords.

Return values:

<CodeWord> CW11 | CW12
 *RST: CW11

Example: See [\[:SOURce<hw>\]:BB:EUTRa:DL:EMTC:ALLOc<ch0>:PRECoding:TRSCHEME?](#) on page 884.

Usage: Query only

Manual operation: See ["Codeword"](#) on page 454

[:SOURce<hw>]:BB:EUTRa:DL:EMTC:ALLOc<ch0>:PRECoding:NOLayers?

Queries the number of layers for the selected allocation.

Return values:

<PrecLayCnt> integer
 Range: 1 to 2
 *RST: 1

Example: See [Example"MPDCCH and PDSCH DCI-based configuration \(DCI format 6-1A\)"](#) on page 816.

Usage: Query only

Manual operation: See ["Number of Layers"](#) on page 450
 See ["Number of Layers"](#) on page 454

[:SOURCE<hw>]:BB:EUTRa:DL:EMTC:ALLoc<ch0>:PRECoding:CCD
 <CycDelDiv>

Sets the cyclic delay diversity for the selected allocation.

Parameters:

<CycDelDiv> NOCDd | LADelay
 *RST: NOCDd

Example: See [Example"MPDCCH and PDSCH DCI-based configuration \(DCI format 6-1A\)"](#) on page 816.

Manual operation: See ["Cyclic Delay Diversity"](#) on page 454

[:SOURCE<hw>]:BB:EUTRa:DL:EMTC:ALLoc<ch0>:PRECoding:CBIndex
 <PrecCodeBookIdx>

Sets the codebook index.

Parameters:

<PrecCodeBookIdx> integer
 Range: 0 to 15
 *RST: 0

Example: See [Example"MPDCCH and PDSCH DCI-based configuration \(DCI format 6-1A\)"](#) on page 816.

Manual operation: See ["Codebook Index"](#) on page 454

[:SOURCE<hw>]:BB:EUTRa:DL:EMTC:ALLoc<ch0>:PRECoding:TRScheme?

Queries the transmission scheme.

Return values:

<TranScheme> TM9
 *RST: TM9

Example:

```
// Transmission antennas and antenna port mapping
SOURCE1:BB:EUTRa:DL:MIMO:CONFIguration TX2
SOURCE1:BB:EUTRa:DL:MIMO:ANTenna ANT1

SOURCE1:BB:EUTRa:STDMode IOT
SOURCE1:BB:EUTRa:DL:USER4:RELease EM_A
SOURCE1:BB:EUTRa:DL:USER4:UEC?
// M1
SOURCE1:BB:EUTRa:DL:USER4:CELL0:TXM M9

SOURCE1:BB:EUTRa:DL:EMTC:DCI:NALLoc 1
SOURCE1:BB:EUTRa:DL:EMTC:DCI:ALLoc0:USER USER4
SOURCE1:BB:EUTRa:DL:EMTC:DCI:ALLoc0:FMT F61A

SOURCE1:BB:EUTRa:DL:EMTC:NALLoc?
// 4
// PDSCH allocation not carrying SIB-BR is the fourth allocation
SOURCE1:BB:EUTRa:DL:EMTC:ALLoc3:CONType?
// PDSCH

SOURCE1:BB:EUTRa:DL:EMTC:ALLoc3:PRECoding:SCHEME?
// BF
// because User 1 uses Tx mode TM9
SOURCE1:BB:EUTRa:DL:EMTC:ALLoc3:PRECoding:TRSCHEME?
// TM9
SOURCE1:BB:EUTRa:DL:EMTC:ALLoc3:CODWords?
SOURCE1:BB:EUTRa:DL:EMTC:ALLoc3:PRECoding:NOLayers?
// 1
SOURCE1:BB:EUTRa:DL:EMTC:ALLoc3:PRECoding:AP?
// AP7
SOURCE1:BB:EUTRa:DL:EMTC:ALLoc3:PRECoding:SCID?
// 0
SOURCE1:BB:EUTRa:DL:EMTC:ALLoc3:PRECoding:APM?
// FW
```

Usage: Query only

Manual operation: See "[Transmission Scheme](#)" on page 454

[:SOURCE<hw>] : BB : EUTRa : DL : EMTC : ALLoc<ch0> : PRECoding : AP ?

Queries the used antenna ports.

Return values:

```
<AntPorts> AP7 | AP5 | AP8 | AP78 | AP79 | AP710 | AP711 | AP712 |
AP713 | AP714 | AP107 | AP108 | AP109 | AP110 | AP107108 |
AP107109
*RST: AP7
```

Example: See [:SOURCE<hw>] : BB : EUTRa : DL : EMTC : ALLoc<ch0> : PRECoding : TRSCHEME ? on page 884.

Usage: Query only

Manual operation: See ["Antenna Ports"](#) on page 454

[:SOURce<hw>]:BB:EUTRa:DL:EMTC:ALLoc<ch0>:PRECoding:SCID?

Queries the scrambling identity.

Return values:

<ScramIdent> integer
 Range: 0 to 1
 *RST: 0

Example: See [Example"MPDCCH and PDSCH DCI-based configuration \(DCI format 6-1A\)"](#) on page 816.

Usage: Query only

Manual operation: See ["Scrambling Identity n_SCID"](#) on page 455

[:SOURce<hw>]:BB:EUTRa:DL:EMTC:ALLoc<ch0>:PRECoding:APM?

Queries the antenna port mapping method.

Return values:

<AntPortMap> CB | RCB | FW
 CB = codebook
 RCB = random codebook
 FW = fixed weights
 *RST: CB

Example: See [\[:SOURce<hw>\]:BB:EUTRa:DL:EMTC:ALLoc<ch0>:PRECoding:TRSScheme?](#) on page 884.

Usage: Query only

Manual operation: See ["Antenna Port Mapping"](#) on page 455

**[:SOURce<hw>]:BB:EUTRa:DL:EMTC:ALLoc<ch0>:PRECoding:DAFormat
 <CoordMapMode>**

Switches between the cartesian and cylindrical coordinates representation.

Parameters:

<CoordMapMode> CARTesian | CYLindrical
 *RST: CARTesian

Manual operation: See ["Mapping Coordinates"](#) on page 455

**[:SOURce<hw>]:BB:EUTRa:DL:EMTC:ALLoc<ch0>:PRECoding:AP<dir0>:
 BB<st0>:REAL?**

Defines the mapping of the antenna ports to the physical antennas.

Suffix:

<dir0> 5 | 7 to 14
antenna port

Return values:

<DataReal> float
The REAL (Magnitude) and IMAGinary (Phase) values are interdependent. Their value ranges change depending on each other and so that the resulting complex value is as follows:
 $|\text{REAL} + j * \text{IMAGinary}| \leq 1$
Otherwise, the values are normalized to Magnitude = 1.
Range: -1 to 1
Increment: 0.001
*RST: 0

Usage: Query only

Manual operation: See "[Mapping Table](#)" on page 455

[:SOURce<hw>]:BB:EUTRa:DL:EMTC:ALLoc<ch0>:PRECoding:AP<dir0>:BB<st0>:IMAGinary?

Defines the mapping of the antenna ports to the physical antennas.

Suffix:

<dir0> 5 | 7 to 14
antenna port

Return values:

<DataImag> float
The REAL (Magnitude) and IMAGinary (Phase) values are interdependent. Their value ranges change depending on each other and so that the resulting complex value is as follows:
 $|\text{REAL} + j * \text{IMAGinary}| \leq 1$
Otherwise, the values are normalized to Magnitude = 1.
Range: -1 to 360
Increment: 0.001
*RST: 0

Usage: Query only

Manual operation: See "[Mapping Table](#)" on page 455

[:SOURce<hw>]:BB:EUTRa:DL:EMTC:ALLoc<ch0>:SCRambling:STATE<ScramState>

Enables scrambling.

Parameters:

<ScramState> 1 | ON | 0 | OFF
*RST: 1

Example: See [Example"MPDCCH and PDSCH DCI-based configuration \(DCI format 6-1A\)"](#) on page 816.

Manual operation: See ["Scrambling State"](#) on page 450
See ["Scrambling State"](#) on page 456

[:SOURCE<hw>]:BB:EUTRa:DL:EMTC:ALLoc<ch0>:SCRambling:UEID?

Queries the user equipment identifier (n_RNTI) or UE ID of the user to which the PDSCH transmission is intended.

Return values:

<UEID> integer
Range: 0 to 65535
*RST: 0

Example: See [Example"MPDCCH and PDSCH DCI-based configuration \(DCI format 6-1A\)"](#) on page 816.

Usage: Query only

Manual operation: See ["UE ID/n_RNTI"](#) on page 450
See ["UE ID/n_RNTI"](#) on page 456

[:SOURCE<hw>]:BB:EUTRa:DL:EMTC:ALLoc<ch0>:CCODing:STATe <ChanCodState>

Enables channel coding.

Parameters:

<ChanCodState> 1 | ON | 0 | OFF
*RST: 1

Example: See [Example"MPDCCH and PDSCH DCI-based configuration \(DCI format 6-1A\)"](#) on page 816.

Manual operation: See ["Channel Coding State"](#) on page 450
See ["Channel Coding State"](#) on page 456

[:SOURCE<hw>]:BB:EUTRa:DL:EMTC:ALLoc<ch0>:CCODing:TBSize?

Queries the size of the transport block/payload in bits.

Return values:

<ChanCodTranBlck> integer
Range: 34 to 1E4
*RST: 16

Example: See [Example"MPDCCH and PDSCH DCI-based configuration \(DCI format 6-1A\)"](#) on page 816.

Usage: Query only

Manual operation: See ["Transport Block Size/Payload \(DL\)"](#) on page 452
See ["Transport Block Size/Payload \(DL\)"](#) on page 457

[:SOURce<hw>]:BB:EUTRa:DL:EMTC:ALLoc<ch0>:CCODing:TBSI
<ChanCodTBSIndex>

Queries the resulting transport block size index.

Parameters:

<ChanCodTBSIndex> integer

Range: 34 to 34

*RST: 34

Example: See [Example"MPDCCH and PDSCH DCI-based configuration \(DCI format 6-1A\)"](#) on page 816.

Manual operation: See ["Transport Block Size \$I_{TBS}\$ "](#) on page 457

[:SOURce<hw>]:BB:EUTRa:DL:EMTC:ALLoc<ch0>:CCODing:MIB
<ChanCodMibState>

Enables transmission of real MIB (master information block) data.

Parameters:

<ChanCodMibState> 1 | ON | 0 | OFF

*RST: 1

Example: See [Example"PBCH and SIB1-BR configuration"](#) on page 818.

Manual operation: See ["MIB \(including SFN\)"](#) on page 451

[:SOURce<hw>]:BB:EUTRa:DL:EMTC:ALLoc<ch0>:CCODing:SIB
<SchedulingSIB1>

Sets the parameter `schedulingInfoSIB1-RB` and defines the PDSCH number of repetitions.

Query the resulting number of repetitions with the command `[:SOURce<hw>]:BB:EUTRa:DL:EMTC:ALLoc<ch0>:CCODing:RSIB?`.

Parameters:

<SchedulingSIB1> integer

Range: 0 to 18

*RST: 0

Example: See [Example"PBCH and SIB1-BR configuration"](#) on page 818.

Manual operation: See ["Scheduling Info SIB1-RB"](#) on page 452

[:SOURce<hw>]:BB:EUTRa:DL:EMTC:ALLoc<ch0>:CCODing:RSIB?

Queries the number of PDSCH repetitions $N_{\text{Rep}}^{\text{PDSCH}}$, as defined with the command [:SOURce<hw>]:BB:EUTRa:DL:EMTC:ALLoc<ch0>:CCODing:SIB.

Return values:

<PDSCHRepSIB1> integer
 Range: 0 to 11
 *RST: 0

Example: See [Example"PBCH and SIB1-BR configuration"](#) on page 818.

Usage: Query only

Manual operation: See ["PDSCH Repetitions SIB1-RB"](#) on page 452

**[:SOURce<hw>]:BB:EUTRa:DL:EMTC:ALLoc<ch0>:CCODing:MSpare
<MibSpareBits>**

Sets the spare bits in the PBCH transmission.

Parameters:

<MibSpareBits> 5 bits

Example: See [Example"PBCH and SIB1-BR configuration"](#) on page 818.

Manual operation: See ["MIB Spare Bits"](#) on page 452

**[:SOURce<hw>]:BB:EUTRa:DL:EMTC:ALLoc<ch0>:CCODing:SOFFset
<ChanCodSfnOffse>**

Sets the start SFN value.

Parameters:

<ChanCodSfnOffse> float
 Range: 0 to 1020
 Increment: 4
 *RST: 0

Example: See [Example"PBCH and SIB1-BR configuration"](#) on page 818.

Manual operation: See ["SFN Offset"](#) on page 451

**[:SOURce<hw>]:BB:EUTRa:DL:EMTC:ALLoc<ch0>:CCODing:SRPeriod
<SfnRestPeriod>**

Determines the time span after which the SFN (System Frame Number) restarts.

Parameters:

<SfnRestPeriod> PERSlength | PER3gpp
 PER3gpp = "3GPP (1024 Frames)"
 PERSlength = SFN restart period to the ARB sequence length
 *RST: PERSlength

- Example:** See [Example"PBCH and SIB1-BR configuration"](#) on page 818.
- Options:** R&S SMM-K84
- Manual operation:** See ["SFN Restart Period"](#) on page 451

10.27.2.8 MPDCCH configuration

This section lists the MPDCCH-specific commands; for description of the commands common to EPDCCH and MPDCCH, see [Chapter 10.22, "EPDCCH"](#), on page 738.

Example: Configuring the MPDCCH sets

```
SOURcel:BB:EUTRa:DUPLexing FDD
SOURcel:BB:EUTRa:LINK DOWN
SOURcel:BB:EUTRa:STDMoDe IOT

// enable an eMTC UE, e.g. supporting eMTC CE Mode A
SOURcel:BB:EUTRa:DL:USER1:RELease EM_A

SOURcel:BB:EUTRa:DL:USER1:EPDCch1:STATe 1
SOURcel:BB:EUTRa:DL:USER1:EPDCch1:SET1:STATe 1
SOURcel:BB:EUTRa:DL:USER1:EPDCch1:SET2:STATe 1

SOURcel:BB:EUTRa:DL:USER1:EPDCch:CELL0:SET1:TTYP LOC
SOURcel:BB:EUTRa:DL:USER1:EPDCch:CELL0:SET1:PRBS PRB2
SOURcel:BB:EUTRa:DL:USER1:EPDCch:CELL0:SET1:RBA 2
SOURcel:BB:EUTRa:DL:USER1:EPDCch:CELL0:SET1:NID 22
SOURcel:BB:EUTRa:DL:USER1:EPDCch:CELL0:SET1:POWEr 0
SOURcel:BB:EUTRa:DL:USER1:EPDCch:CELL0:SET1:HOPPIng 1
SOURcel:BB:EUTRa:DL:USER1:EPDCch:CELL0:SET1:STNB 1
SOURcel:BB:EUTRa:DL:USER1:EPDCch:CELL0:SET1:REPMdcch 16
SOURcel:BB:EUTRa:DL:USER1:EPDCch:CELL0:SET1:STSF S1

// MPDCCH allocations are configured automatically,
// depending on the eMTC DCI configuration

[:SOURce<hw>]:BB:EUTRa:DL:USER<ch>:EPDCch:CELL<st0>:SET<dir>:HOPPIng.....891
[:SOURce<hw>]:BB:EUTRa:DL:USER<ch>:EPDCch:CELL<st0>:SET<dir>:REPMdcch..... 892
[:SOURce<hw>]:BB:EUTRa:DL:USER<ch>:EPDCch:CELL<st0>:SET<dir>:STNB..... 892
[:SOURce<hw>]:BB:EUTRa:DL:USER<ch>:EPDCch:CELL<st0>:SET<dir>:STSF.....892
```

**[:SOURce<hw>]:BB:EUTRa:DL:USER<ch>:EPDCch:CELL<st0>:SET<dir>:
HOPPIng <Hopping>**

Enables MPDCCH hopping.

Parameters:

<Hopping> 1 | ON | 0 | OFF
*RST: 0

Example: See [Example"Configuring the MPDCCH sets"](#) on page 815.

Options: R&S SMM-K115
Manual operation: See ["Hopping"](#) on page 151

[:SOURCE<hw>]:BB:EUTRa:DL:USER<ch>:EPDCch:CELL<st0>:SET<dir>:REPMpdccch <MaxRepMPDCCH>

Sets the maximum number the MPDCCH is repeated.

Parameters:
 <MaxRepMPDCCH> 1 | 2 | 4 | 8 | 16 | 32 | 64 | 128 | 256
 *RST: 1

Example: See [Example"Configuring the MPDCCH sets"](#) on page 815.

Options: R&S SMM-K115
Manual operation: See ["Max. Repetitions MPDCCH \(Rmax\)"](#) on page 151

[:SOURCE<hw>]:BB:EUTRa:DL:USER<ch>:EPDCch:CELL<st0>:SET<dir>:STNB <StartingNB>

Sets the first narrowbands in which MPDCCH is allocated.

Parameters:
 <StartingNB> integer
 Range: 0 to 15
 *RST: 0

Example: See [Example"Configuring the MPDCCH sets"](#) on page 815.

Options: R&S SMM-K115
Manual operation: See ["Starting NB"](#) on page 151

[:SOURCE<hw>]:BB:EUTRa:DL:USER<ch>:EPDCch:CELL<st0>:SET<dir>:STSF <SearchSpStartSf>

Sets the first subframe of the search space.

Parameters:
 <SearchSpStartSf> S1 | S1_5 | S2 | S2_5 | S5 | S8 | S10 | S20 | S4
 *RST: S1

Example: See [Example"Configuring the MPDCCH sets"](#) on page 815.

Options: R&S SMM-K115
Manual operation: See ["Search Space Start Subframe"](#) on page 152

10.27.3 General IoT uplink

<code>[:SOURce<hw>]:BB:EUTRa:UL:EMTC:NNBands?</code>	893
<code>[:SOURce<hw>]:BB:EUTRa:UL:EMTC:NWBands?</code>	894
<code>[:SOURce<hw>]:BB:EUTRa:UL:EMTC:WBCFg</code>	894
<code>[:SOURce<hw>]:BB:EUTRa:UL:EMTC:RSYMBOL</code>	894
<code>[:SOURce<hw>]:BB:EUTRa:UL:NIOT:SUBConfig</code>	894
<code>[:SOURce<hw>]:BB:EUTRa:UL:NIOT:VALid:SUBFrame<dir></code>	895
<code>[:SOURce<hw>]:BB:EUTRa:UL:EMTC:VALid:SUBFrame<dir></code>	895
<code>[:SOURce<hw>]:BB:EUTRa:UL:PUSCh:NHOPping</code>	895
<code>[:SOURce<hw>]:BB:EUTRa:UL:PUSCh:NHOFFset</code>	895
<code>[:SOURce<hw>]:BB:EUTRa:UL:REFSig:DRS:GHOPping</code>	895
<code>[:SOURce<hw>]:BB:EUTRa:UL:REFSig:DRS:DSEQshift</code>	896
<code>[:SOURce<hw>]:BB:EUTRa:UL:REFSig:DRS:TTCShift</code>	896
<code>[:SOURce<hw>]:BB:EUTRa:UL:REFSig:DRS:STCShift</code>	896
<code>[:SOURce<hw>]:BB:EUTRa:UL:REFSig:DRS:USEBase</code>	896
<code>[:SOURce<hw>]:BB:EUTRa:UL:REFSig:DRS:TTBSequence</code>	897
<code>[:SOURce<hw>]:BB:EUTRa:UL:REFSig:DRS:STBSequence</code>	897
<code>[:SOURce<hw>]:BB:EUTRa:UL:REFSig:DRS:TWBSequence</code>	897
<code>[:SOURce<hw>]:BB:EUTRa:UL:PRACH:NIOT:PFMT</code>	897
<code>[:SOURce<hw>]:BB:EUTRa:UL:PRACH:NIOT:CFG<ch0>:PERD</code>	898
<code>[:SOURce<hw>]:BB:EUTRa:UL:PRACH:NIOT:CFG<ch0>:STTM</code>	898
<code>[:SOURce<hw>]:BB:EUTRa:UL:PRACH:NIOT:CFG<ch0>:REP</code>	898
<code>[:SOURce<hw>]:BB:EUTRa:UL:PRACH:NIOT:CFG<ch0>:SUBC</code>	898
<code>[:SOURce<hw>]:BB:EUTRa:UL:PRACH:NIOT:CFG<ch0>:SCOF</code>	899
<code>[:SOURce<hw>]:BB:EUTRa:UL:PRACH:EMTC:RSET</code>	899
<code>[:SOURce<hw>]:BB:EUTRa:UL:PRACH:EMTC:HOFf</code>	899
<code>[:SOURce<hw>]:BB:EUTRa:UL:PRACH:EMTC:CELV<ch0>:CONFIg</code>	900
<code>[:SOURce<hw>]:BB:EUTRa:UL:PRACH:EMTC:CELV<ch0>:HOPPIg</code>	900
<code>[:SOURce<hw>]:BB:EUTRa:UL:PRACH:EMTC:CELV<ch0>:REPetit</code>	900
<code>[:SOURce<hw>]:BB:EUTRa:UL:PRACH:EMTC:CELV<ch0>:FOFFset</code>	900
<code>[:SOURce<hw>]:BB:EUTRa:UL:PRACH:EMTC:CELV<ch0>:SSFPeriod</code>	901

`[:SOURce<hw>]:BB:EUTRa:UL:EMTC:NNBands?`

Queries the number of eMTC narrowbands N_{RB}^{UL} available within the selected channel bandwidth.

Return values:

<NumNarrowbands> integer
 Range: 0 to 18
 *RST: 1

Example: See [Example "eMTC PUSCH configuration"](#) on page 820.

Usage: Query only

Manual operation: See ["Number of eMTC Narrowbands"](#) on page 227

[[:SOURce<hw>]:BB:EUTRa:UL:EMTC:NWBands?

Queries the number of widebands.

Return values:

<NumWideBands> integer
Range: 0 to 4
*RST: 1

Example: See [Example "eMTC widebands configuration"](#) on page 814.

Usage: Query only

Options: R&S SMM-K143

Manual operation: See ["Number of eMTC Widebands"](#) on page 228

[[:SOURce<hw>]:BB:EUTRa:UL:EMTC:WBCFg <WBConfig>

If enabled, the available channel bandwidth is split into eMTC widebands.

Parameters:

<WBConfig> 1 | ON | 0 | OFF
*RST: 0

Example: See [Example "eMTC widebands configuration"](#) on page 814.

Options: R&S SMM-K143

Manual operation: See ["Wideband Config"](#) on page 228

[[:SOURce<hw>]:BB:EUTRa:UL:EMTC:RSYMBOL <RetuningSymbol>

Sets the number of retuning symbols.

Parameters:

<RetuningSymbol> integer
Range: 0 to 2
*RST: 2

Example: See [Example "eMTC widebands configuration"](#) on page 814.

Options: R&S SMM-K143

Manual operation: See ["Retuning Symbols"](#) on page 232

[[:SOURce<hw>]:BB:EUTRa:UL:NIOT:SUBConfig <SfConfig>

Sets the number of subframes in the bitmap.

Parameters:

<SfConfig> N10 | N40
*RST: N10

Options: R&S SMM-K146

[:SOURce<hw>]:BB:EUTRa:UL:NIOT:VALid:SUBFrame<dir> <ValidSubframe>
[:SOURce<hw>]:BB:EUTRa:UL:EMTC:VALid:SUBFrame<dir> <ValidSubFrames>

Sets a subframe as valid and used for eMTC transmission.

Suffix:

<dir> 0 to 9
 Subframe number

Parameters:

<ValidSubFrames> 1 | ON | 0 | OFF
 *RST: 1

Example: See [Example "eMTC PUSCH configuration"](#) on page 820.

Manual operation: See ["Valid Subframes"](#) on page 232

[:SOURce<hw>]:BB:EUTRa:UL:PUSCh:NHOPping <NBHopping>

Enables narrowband hopping.

Parameters:

<NBHopping> 1 | ON | 0 | OFF
 *RST: 1

Example: See [Example "eMTC PUSCH configuration"](#) on page 820.

Manual operation: See ["Narrowband Hopping"](#) on page 460

[:SOURce<hw>]:BB:EUTRa:UL:PUSCh:NHOFFset <NBHoppingOffset>

Sets the narrowband hopping offset.

Parameters:

<NBHoppingOffset> integer
 Range: 1 to 16
 *RST: 3

Example: See [Example "eMTC PUSCH configuration"](#) on page 820.

Manual operation: See ["Hopping Offset"](#) on page 460

[:SOURce<hw>]:BB:EUTRa:UL:REFSig:DRS:GHOPping <GroupHopping>

Enables NDRS group hopping.

Parameters:

<GroupHopping> 1 | ON | 0 | OFF
 *RST: 0

Example: See [Example "NPUSCH and NDRS configuration"](#) on page 810.

Manual operation: See ["Group Hopping"](#) on page 409

[:SOURce<hw>]:BB:EUTRa:UL:REFSig:DRS:DSEQshift <DeltaSeqShift>

Sets the delta sequence shift for NPUSCH required for the calculation of the NDRS group hopping pattern.

Parameters:

<DeltaSeqShift> integer
 Range: 0 to 29
 *RST: 0

Example: See [Example "NPUSCH and NDRS configuration"](#) on page 810.

Manual operation: See ["Delta Sequence Shift for NPUSCH"](#) on page 409

[:SOURce<hw>]:BB:EUTRa:UL:REFSig:DRS:TTCShift <ThreeToneCycShi>

Sets the three tone cyclic shift.

Parameters:

<ThreeToneCycShi> integer
 Range: 0 to 2
 *RST: 0

Example: See [Example "NPUSCH and NDRS configuration"](#) on page 810.

Manual operation: See ["Three/Six-Tone Cyclic Shift"](#) on page 409

[:SOURce<hw>]:BB:EUTRa:UL:REFSig:DRS:STCShift <SixToneCycShift>

Sets the six tone cyclic shift.

Parameters:

<SixToneCycShift> integer
 Range: 0 to 3
 *RST: 0

Example: See [Example "NPUSCH and NDRS configuration"](#) on page 810.

Manual operation: See ["Three/Six-Tone Cyclic Shift"](#) on page 409

[:SOURce<hw>]:BB:EUTRa:UL:REFSig:DRS:USEBase <UseBaseSequence>

Enables using base sequences for the generation of the NB-IoT DMRS sequence hopping pattern.

Parameters:

<UseBaseSequence> 1 | ON | 0 | OFF
 *RST: 0

Example: See [Example "NPUSCH and NDRS configuration"](#) on page 810.

Manual operation: See ["Use Base Sequences"](#) on page 409

[:SOURce<hw>]:BB:EUTRa:UL:REFSig:DRS:TTBSequence <ThreeToneBaseSq>

Sets the three tone base sequence.

Parameters:

<ThreeToneBaseSq> integer
 Range: 0 to 12
 *RST: 0

Example: See [Example"NPUSCH and NDRS configuration"](#) on page 810.

Manual operation: See ["Three/Six/Twelve-Tone Base Sequence"](#) on page 410

[:SOURce<hw>]:BB:EUTRa:UL:REFSig:DRS:STBSequence <SixToneBaseSeq>

Sets the six tone base sequence.

Parameters:

<SixToneBaseSeq> integer
 Range: 0 to 14
 *RST: 0

Example: See [Example"NPUSCH and NDRS configuration"](#) on page 810.

Manual operation: See ["Three/Six/Twelve-Tone Base Sequence"](#) on page 410

[:SOURce<hw>]:BB:EUTRa:UL:REFSig:DRS:TWBSequence <TwelveToneBaseS>

Sets the 12 tone base sequence.

Parameters:

<TwelveToneBaseS> integer
 Range: 0 to 30
 *RST: 0

Example: See [Example"NPUSCH and NDRS configuration"](#) on page 810.

Manual operation: See ["Three/Six/Twelve-Tone Base Sequence"](#) on page 410

[:SOURce<hw>]:BB:EUTRa:UL:PRACH:NIOT:PFMT <PreambleFormat>

Select the preamble format.

Parameters:

<PreambleFormat> F0 | F1 | 0 | 1 | F2 | F0A | F1A
 0 | 1 backward compatibility; use F0 | F1 instead.
 *RST: 0

Example: See [Example"NPRACH configuration"](#) on page 812.

Options: 2|0A|1A require R&S SMM-K146

Manual operation: See ["Preamble Format"](#) on page 424

[:SOURCE<hw>]:BB:EUTRa:UL:PRACH:NIOT:CFG<ch0>:PERD <Periodicity>

Sets NPRACH periodicity.

Parameters:

<Periodicity> 40 | 80 | 160 | 240 | 320 | 640 | 1280 | 2560 | 5120 | 10240
*RST: 40

Example: See [Example"NPRACH configuration"](#) on page 812.

Options: 5120|10240 require R&S SMM-K146

Manual operation: See ["Periodicity, ms"](#) on page 424

[:SOURCE<hw>]:BB:EUTRa:UL:PRACH:NIOT:CFG<ch0>:STTM <StartTime>

Sets the start time of the specific NPRACH configuration.

Parameters:

<StartTime> 8 | 16 | 64 | 128 | 32 | 256 | 512 | 1024 | 10 | 20 | 40 | 80 | 160 | 320 | 640 | 1280 | 2560 | 5120
*RST: 8

Example: See [Example"NPRACH configuration"](#) on page 812.

Options: 10|20|40|80|160|320|640|1280|2560|5120 require R&S SMM-K146

Manual operation: See ["Starting Time, ms"](#) on page 424

[:SOURCE<hw>]:BB:EUTRa:UL:PRACH:NIOT:CFG<ch0>:REP <Repetitions>

Queries the number of NPRACH repetitions per preamble attempt.

Parameters:

<Repetitions> R1 | R2 | R4 | R8 | R16 | R32 | R64 | R128 | R192 | R256 | R384 | R512 | R768 | R1024 | R1536 | R2048 | R12 | R24
*RST: R1

Example: See [Example"NPRACH configuration"](#) on page 812.

Options: R192|R256|R384|R512|R768|R1024|R1536|R2048|R12|R24 require R&S SMM-K146

Manual operation: See ["Number of Repetitions"](#) on page 425

[:SOURCE<hw>]:BB:EUTRa:UL:PRACH:NIOT:CFG<ch0>:SUBC <Subcarriers>

Sets the number of NPRACH subcarriers.

Parameters:

<Subcarriers> 12 | 24 | 36 | 48
*RST: 12

Example: See [Example"NPRACH configuration"](#) on page 812.

Manual operation: See ["Number of Subcarriers"](#) on page 425

[:SOURCE<hw>]:BB:EUTRa:UL:PRACH:NIOT:CFG<ch0>:SCOF <SubcarrierOffse>

Sets the NPRACH subcarrier offset.

Parameters:

<SubcarrierOffse> 0 | 2 | 12 | 18 | 24 | 34 | 36 | 6 | 42 | 48 | 54 | 60 | 72 | 78 | 84 |
90 | 102 | 108
*RST: 0

Example: See [Example"NPRACH configuration"](#) on page 812.

Options: 6|42|48|54|60|72|78|84|90|102|108 require R&S SMM-K146

Manual operation: See ["Subcarrier Offset"](#) on page 425

[:SOURCE<hw>]:BB:EUTRa:UL:PRACH:EMTC:RSET <RestrictedSet>

Enables using the restricted set.

Parameters:

<RestrictedSet> URES | ARES | BRES | OFF | ON
URES|OFF
Unrestricted preamble set.
ARES|ON
Restricted set type A.
BRES
Restricted set type B.
*RST: URES

Example: See [Example"eMTC PRACH configuration"](#) on page 822.

Manual operation: See ["Restricted Set"](#) on page 479

[:SOURCE<hw>]:BB:EUTRa:UL:PRACH:EMTC:HOFF <HoppingOffset>

Sets a PRACH hopping offset as number of resource blocks (RB).

Parameters:

<HoppingOffset> integer
Range: 1 to 110
*RST: 0

Example: See [Example"eMTC PRACH configuration"](#) on page 822.

Manual operation: See ["Hopping Offset"](#) on page 479

[:SOURce<hw>]:BB:EUTRa:UL:PRACH:EMTC:CELV<ch0>:CONFig <Config>

Selects the PRACH configuration index.

Parameters:

<Config> integer
 Range: 0 to 63
 *RST: 0

Example: See [Example "eMTC PRACH configuration"](#) on page 822.

Manual operation: See ["PRACH Configuration"](#) on page 479

[:SOURce<hw>]:BB:EUTRa:UL:PRACH:EMTC:CELV<ch0>:HOPPIng <Hopping>

Enables frequency hopping.

Parameters:

<Hopping> 1 | ON | 0 | OFF
 *RST: 0

Example: See [Example "eMTC PRACH configuration"](#) on page 822.

Manual operation: See ["Hopping"](#) on page 480

[:SOURce<hw>]:BB:EUTRa:UL:PRACH:EMTC:CELV<ch0>:REPetit <Repetitions>

Sets the PRACH number of repetitions.

Parameters:

<Repetitions> R1 | R2 | R4 | R8 | R16 | R32 | R64 | R128
 *RST: R1

Example: See [Example "eMTC PRACH configuration"](#) on page 822.

Manual operation: See ["Number of Repetitions"](#) on page 480

**[:SOURce<hw>]:BB:EUTRa:UL:PRACH:EMTC:CELV<ch0>:FOFFset
 <FrequencyOffset>**

Sets a frequency offset in terms of resource blocks.

Parameters:

<FrequencyOffset> integer
 Range: 0 to 94
 *RST: 0

Example: See [Example "eMTC PRACH configuration"](#) on page 822.

Manual operation: See ["Freq. Offsets"](#) on page 480

[:SOURce<hw>]:BB:EUTRa:UL:PRACH:EMTC:CELV<ch0>:SSFPeriod
 <StartSfPeriod>

Sets the starting subframe periodicity.

Parameters:

<StartSfPeriod> NONE | 4 | 2 | 8 | 16 | 32 | 64 | 128 | 256
 *RST: NONE

Example: See [Example "eMTC PRACH configuration"](#) on page 822.

Manual operation: See ["Starting SF Periodicity"](#) on page 480

10.27.4 IoT UE configuration

[:SOURce<hw>]:BB:EUTRa:UL:UE<st>:NIOT:GHDisable.....	903
[:SOURce<hw>]:BB:EUTRa:UL:UE<st>:NIOT:SCSPacing.....	903
[:SOURce<hw>]:BB:EUTRa:UL:UE<st>:NIOT:RBIndex.....	903
[:SOURce<hw>]:BB:EUTRa:UL:UE<st>:NIOT:DFReq.....	904
[:SOURce<hw>]:BB:EUTRa:UL:UE<st>:NIOT:MODE.....	904
[:SOURce<hw>]:BB:EUTRa:UL:UE<st>:NIOT:NTRansmiss.....	904
[:SOURce<hw>]:BB:EUTRa:UL:UE<st>:NIOT:TRANS<ch>:FORMat.....	904
[:SOURce<hw>]:BB:EUTRa:UL:UE<st>:NIOT:TRANS<ch>:MODulation.....	905
[:SOURce<hw>]:BB:EUTRa:UL:UE<st>:NIOT:TRANS<ch>:STSFrame.....	905
[:SOURce<hw>]:BB:EUTRa:UL:UE<st>:NIOT:TRANS<ch>:REPetitions.....	905
[:SOURce<hw>]:BB:EUTRa:UL:UE<st>:NIOT:TRANS<ch>:NRUNits.....	905
[:SOURce<hw>]:BB:EUTRa:UL:UE<st>:NIOT:TRANS<ch>:SIRF.....	906
[:SOURce<hw>]:BB:EUTRa:UL:UE<st>:NIOT:TRANS<ch>:NSCarriers?.....	906
[:SOURce<hw>]:BB:EUTRa:UL:UE<st>:NIOT:TRANS<ch>:NSLTs?.....	906
[:SOURce<hw>]:BB:EUTRa:UL:UE<st>:NIOT:TRANS<ch>:STSCarrier?.....	907
[:SOURce<hw>]:BB:EUTRa:UL:UE<st>:NIOT:TRANS<ch>:STSLot?.....	907
[:SOURce<hw>]:BB:EUTRa:UL:UE<st>:NIOT:TRANS<ch>:POWER.....	907
[:SOURce<hw>]:BB:EUTRa:UL:UE<st>:NIOT:ARB:SUGGested?.....	907
[:SOURce<hw>]:BB:EUTRa:UL:UE<st>:NIOT:NPSSim.....	908
[:SOURce<hw>]:BB:EUTRa:UL:UE<st>:NIOT:TRANS<ch>:HARQ:BITS?.....	908
[:SOURce<hw>]:BB:EUTRa:UL:UE<st>:NIOT:TRANS<ch>:HARQ:CBITS?.....	908
[:SOURce<hw>]:BB:EUTRa:UL:UE<st>:NIOT:TRANS<ch>:HARQ:PATtern.....	909
[:SOURce<hw>]:BB:EUTRa:UL:UE<st>:NIOT:TRANS<ch>:HARQ:SR.....	909
[:SOURce<hw>]:BB:EUTRa:UL:UE<st>:NIOT:TRANS<ch>:PUSCh:ESUPport.....	909
[:SOURce<hw>]:BB:EUTRa:UL:UE<st>:NIOT:TRANS<ch>:PUSCh:ETBS.....	909
[:SOURce<hw>]:BB:EUTRa:UL:UE<st>:NIOT:TRANS<ch>:PUSCh:ETRSize.....	910
[:SOURce<hw>]:BB:EUTRa:UL:UE<st>:NIOT:TRANS<ch>:PUSCh:PHYSbits?.....	910
[:SOURce<hw>]:BB:EUTRa:UL:UE<st>:NIOT:TRANS<ch>:PUSCh:RUIIndex?.....	910
[:SOURce<hw>]:BB:EUTRa:UL:UE<st>:NIOT:TRANS<ch>:PUSCh:RVIndex.....	911
[:SOURce<hw>]:BB:EUTRa:UL:UE<st>:NIOT:TRANS<ch>:PUSCh:TBIIndex.....	911
[:SOURce<hw>]:BB:EUTRa:UL:UE<st>:NIOT:TRANS<ch>:PUSCh:TBSIZE?.....	911
[:SOURce<hw>]:BB:EUTRa:UL:UE<st>:NIOT:FRC:TYPE.....	912
[:SOURce<hw>]:BB:EUTRa:UL:UE<st>:NIOT:FRC:STATE.....	912
[:SOURce<hw>]:BB:EUTRa:UL:UE<st>:NIOT:FRC:ALResunits?.....	912
[:SOURce<hw>]:BB:EUTRa:UL:UE<st>:NIOT:FRC:BPRResunit?.....	912

[SOURce<hw>]:BB:EUTRa:UL:UE<st>:NIOT:FRC:MODulation?	913
[SOURce<hw>]:BB:EUTRa:UL:UE<st>:NIOT:FRC:NNPRep	913
[SOURce<hw>]:BB:EUTRa:UL:UE<st>:NIOT:FRC:NOSCarriers?	913
[SOURce<hw>]:BB:EUTRa:UL:UE<st>:NIOT:FRC:PASize?	913
[SOURce<hw>]:BB:EUTRa:UL:UE<st>:NIOT:FRC:SCSPacing?	914
[SOURce<hw>]:BB:EUTRa:UL:UE<st>:NIOT:FRC:TBSSIndex?	914
[SOURce<hw>]:BB:EUTRa:UL:UE<st>:PRACH:NIOT:MOD	914
[SOURce<hw>]:BB:EUTRa:UL:UE<st>:PRACH:NIOT:PRATtempts	914
[SOURce<hw>]:BB:EUTRa:UL:UE<st>:PRACH:NIOT:RBID	915
[SOURce<hw>]:BB:EUTRa:UL:UE<st>:PRACH:NIOT:DFReq	915
[SOURce<hw>]:BB:EUTRa:UL:UE<st>:PRACH:ATT<ch0>:NIOT:CONFig	915
[SOURce<hw>]:BB:EUTRa:UL:UE<st>:PRACH:ATT<ch0>:NIOT:SFS Tart	915
[SOURce<hw>]:BB:EUTRa:UL:UE<st>:PRACH:ATT<ch0>:NIOT:INIT	916
[SOURce<hw>]:BB:EUTRa:UL:UE<st>:PRACH:ATT<ch0>:NIOT:STRT?	916
[SOURce<hw>]:BB:EUTRa:UL:UE<st>:PRACH:ATT<ch0>:NIOT:POWer	916
[SOURce<hw>]:BB:EUTRa:UL:UE<st>:PRACH:NIOT:ARB:SUGGested?	916
[SOURce<hw>]:BB:EUTRa:UL:UE<st>:NIOT:FRC:TYPE	917
[SOURce<hw>]:BB:EUTRa:UL:UE<st>:NIOT:FRC:STATe	917
[SOURce<hw>]:BB:EUTRa:UL:UE<st>:NIOT:FRC:ALResunits?	917
[SOURce<hw>]:BB:EUTRa:UL:UE<st>:NIOT:FRC:MODulation?	918
[SOURce<hw>]:BB:EUTRa:UL:UE<st>:NIOT:FRC:PASize?	918
[SOURce<hw>]:BB:EUTRa:UL:UE<st>:NIOT:FRC:TBSSIndex?	918
[SOURce<hw>]:BB:EUTRa:UL:UE<st>:NIOT:FRC:SCSPacing?	918
[SOURce<hw>]:BB:EUTRa:UL:UE<st>:NIOT:FRC:PASize?	919
[SOURce<hw>]:BB:EUTRa:UL:UE<st>:NIOT:FRC:NOSCarriers?	919
[SOURce<hw>]:BB:EUTRa:UL:UE<st>:NIOT:FRC:NNPRep	919
[SOURce<hw>]:BB:EUTRa:UL:UE<st>:NIOT:FRC:BPResunit?	919
[SOURce<hw>]:BB:EUTRa:UL:UE<st>:EMTC:CELevel	920
[SOURce<hw>]:BB:EUTRa:UL:UE<st>:EMTC:HOPP	920
[SOURce<hw>]:BB:EUTRa:UL:UE<st>:EMTC:NTRansmiss	920
[SOURce<hw>]:BB:EUTRa:UL:UE<st>:EMTC:TRANs<ch>:CONTEnt	920
[SOURce<hw>]:BB:EUTRa:UL:UE<st>:EMTC:TRANs<ch>:MODulation	921
[SOURce<hw>]:BB:EUTRa:UL:UE<st>:EMTC:TRANs<ch>:FORMat	921
[SOURce<hw>]:BB:EUTRa:UL:UE<st>:EMTC:TRANs<ch>:STsFrame	921
[SOURce<hw>]:BB:EUTRa:UL:UE<st>:EMTC:TRANs<ch>:ASFRame?	921
[SOURce<hw>]:BB:EUTRa:UL:UE<st>:EMTC:TRANs<ch>:REPetitions	922
[SOURce<hw>]:BB:EUTRa:UL:UE<st>:EMTC:TRANs<ch>:STNBand	922
[SOURce<hw>]:BB:EUTRa:UL:UE<st>:EMTC:TRANs<ch>:NRBLocks	922
[SOURce<hw>]:BB:EUTRa:UL:UE<st>:EMTC:TRANs<ch>:RBOFFset	922
[SOURce<hw>]:BB:EUTRa:UL:UE<st>:EMTC:TRANs<ch>:STWBand	923
[SOURce<hw>]:BB:EUTRa:UL:UE<st>:EMTC:TRANs<ch>:WBRBOffset	923
[SOURce<hw>]:BB:EUTRa:UL:UE<st>:EMTC:TRANs<ch>:WRBLocks	923
[SOURce<hw>]:BB:EUTRa:UL:UE<st>:EMTC:TRANs<ch>:POWer	924
[SOURce<hw>]:BB:EUTRa:UL:UE<st>:EMTC:ARB:SUGGested?	924
[SOURce<hw>]:BB:EUTRa:UL:UE<st>:EMTC:TRANs<ch>:DRS:CYCShift?	924
[SOURce<hw>]:BB:EUTRa:UL:UE<st>:EMTC:TRANs<ch>:NDMRs?	924
[SOURce<hw>]:BB:EUTRa:UL:UE<st>:EMTC:TRANs<ch>:PUSCh:CQI:BITS	925
[SOURce<hw>]:BB:EUTRa:UL:UE<st>:EMTC:TRANs<ch>:PUSCh:CQI:PATtern	925
[SOURce<hw>]:BB:EUTRa:UL:UE<st>:EMTC:TRANs<ch>:PUSCh:CQI:CBITs?	925
[SOURce<hw>]:BB:EUTRa:UL:UE<st>:EMTC:TRANs<ch>:HARQ:MODE	926

<code>[:SOURce<hw>]:BB:EUTRa:UL:UE<st>:EMTC:TRANs<ch>:ULSch:BITS?</code>	926
<code>[:SOURce<hw>]:BB:EUTRa:UL:UE<st>:EMTC:TRANs<ch>:CCODing:TBSiZe</code>	926
<code>[:SOURce<hw>]:BB:EUTRa:UL:UE<st>:EMTC:TRANs<ch>:NAPused?</code>	926
<code>[:SOURce<hw>]:BB:EUTRa:UL:UE<st>:EMTC:TRANs<ch>:NPUCch</code>	927
<code>[:SOURce<hw>]:BB:EUTRa:UL:UE<st>:EMTC:TRANs<ch>:HARQ:BITS</code>	927
<code>[:SOURce<hw>]:BB:EUTRa:UL:UE<st>:EMTC:TRANs<ch>:HARQ:CBITs?</code>	927
<code>[:SOURce<hw>]:BB:EUTRa:UL:UE<st>:EMTC:TRANs<ch>:HARQ:PATtern</code>	927
<code>[:SOURce<hw>]:BB:EUTRa:UL:UE<st>:EMTC:TRANs<ch>:PHYSbits?</code>	928
<code>[:SOURce<hw>]:BB:EUTRa:UL:UE<st>:EMTC:TRANs<ch>:CCODing:RVIndex</code>	928
<code>[:SOURce<hw>]:BB:EUTRa:UL:UE<st>:EMTC:TRANs<ch>:PUCCh:HARQ:PATtern</code>	928
<code>[:SOURce<hw>]:BB:EUTRa:UL:UE<st>:EMTC:TRANs<ch>:PUCCh:CQI:BITS</code>	929
<code>[:SOURce<hw>]:BB:EUTRa:UL:UE<st>:EMTC:TRANs<ch>:PUCCh:CQI:PATtern</code>	929
<code>[:SOURce<hw>]:BB:EUTRa:UL:UE<st>:EMTC:TRANs<ch>:PUCCh:CQI:CBITs?</code>	929
<code>[:SOURce<hw>]:BB:EUTRa:UL:UE<st>:PRACH:EMTC:PRATtempts</code>	930
<code>[:SOURce<hw>]:BB:EUTRa:UL:UE<st>:PRACH:ATT<ch0>:EMTC:CELV</code>	930
<code>[:SOURce<hw>]:BB:EUTRa:UL:UE<st>:PRACH:ATT<ch0>:EMTC:SFSTart</code>	930
<code>[:SOURce<hw>]:BB:EUTRa:UL:UE<st>:PRACH:ATT<ch0>:EMTC:FRIndex</code>	930
<code>[:SOURce<hw>]:BB:EUTRa:UL:UE<st>:PRACH:ATT<ch0>:EMTC:NCSConf</code>	931
<code>[:SOURce<hw>]:BB:EUTRa:UL:UE<st>:PRACH:ATT<ch0>:EMTC:RSEquence</code>	931
<code>[:SOURce<hw>]:BB:EUTRa:UL:UE<st>:PRACH:ATT<ch0>:EMTC:SINdex</code>	931
<code>[:SOURce<hw>]:BB:EUTRa:UL:UE<st>:PRACH:ATT<ch0>:EMTC:DT</code>	931
<code>[:SOURce<hw>]:BB:EUTRa:UL:UE<st>:PRACH:ATT<ch0>:EMTC:POWer</code>	932
<code>[:SOURce<hw>]:BB:EUTRa:UL:UE<st>:PRACH:EMTC:ARB:SUGGested?</code>	932

`[:SOURce<hw>]:BB:EUTRa:UL:UE<st>:NIOT:GHDisable <NbiotDisGH>`

Disables NDRS group hopping for the selected UE.

Parameters:

`<NbiotDisGH>` 1 | ON | 0 | OFF
 *RST: 0

Example: See [Example"NPUSCH and NDRS configuration"](#) on page 810.

Manual operation: See ["Disable Group Hopping"](#) on page 410

`[:SOURce<hw>]:BB:EUTRa:UL:UE<st>:NIOT:SCSPacing <SubcarrSpacing>`

Sets the subcarrier spacing.

Parameters:

`<SubcarrSpacing>` S15 | S375
 *RST: S15

Example: See [Example"NPUSCH and NDRS configuration"](#) on page 810.

Manual operation: See ["Subcarrier Spacing"](#) on page 414

`[:SOURce<hw>]:BB:EUTRa:UL:UE<st>:NIOT:RBIndex <ResBlkIndex>`

Sets the resource block number in that the NB-LoT transmissions are allocated.

Parameters:

<ResBlkIndex> integer
 Range: Depends on other values
 *RST: 20

Example: See [Example"NPUSCH and NDRS configuration"](#) on page 810.

Manual operation: See ["Resource Block Index"](#) on page 414

[:SOURce<hw>]:BB:EUTRa:UL:UE<st>:NIOT:DFReq <DeltaFreq>

Sets the frequency offset between the NB-IoT carrier and the LTE center frequency.

Parameters:

<DeltaFreq> float
 Range: -1E7 to 1E7
 Increment: 1000
 Default unit: MHz

Example: See [Example"NPUSCH and NDRS configuration"](#) on page 810.

Manual operation: See ["Delta Frequency to DC, MHz"](#) on page 414

[:SOURce<hw>]:BB:EUTRa:UL:UE<st>:NIOT:MODE <Mode>

Selects the operating mode.

Parameters:

<Mode> INBD | ALON | GBD
 *RST: INBD

Example: See [Example"NPUSCH and NDRS configuration"](#) on page 810.

Manual operation: See ["Mode"](#) on page 415

[:SOURce<hw>]:BB:EUTRa:UL:UE<st>:NIOT:NTRansmiss <NumTransmission>

Sets the number of NPUSCH transmissions.

Parameters:

<NumTransmission> integer
 Range: 1 to 20
 *RST: 1

Example: See [Example"NPUSCH and NDRS configuration"](#) on page 810.

Manual operation: See ["Number of Transmissions"](#) on page 415

[:SOURce<hw>]:BB:EUTRa:UL:UE<st>:NIOT:TRANs<ch>:FORMat <Format>

Sets the NPUSCH transmission format.

Parameters:

<Format> F1 | F2
 *RST: F1

Example: See [Example"NPUSCH and NDRS configuration"](#) on page 810.

Manual operation: See ["NPUSCH Format"](#) on page 415

[:SOURCE<hw>]:BB:EUTRa:UL:UE<st>:NIOT:TRANs<ch>:MODulation
 <Modulation>

Sets the modulation scheme for the NPUSCH transmission.

Parameters:

<Modulation> QPSK | PI2Bpsk | PI4Qpsk | QAM16
 *RST: PI2Bpsk

Example: See [Example"NPUSCH and NDRS configuration"](#) on page 810.

Manual operation: See ["Modulation"](#) on page 415

[:SOURCE<hw>]:BB:EUTRa:UL:UE<st>:NIOT:TRANs<ch>:STSFrame
 <StartSubframe>

Sets the NPUSCH starting subframe.

Parameters:

<StartSubframe> integer
 Range: 0 to 10000
 *RST: 0

Example: See [Example"NPUSCH and NDRS configuration"](#) on page 810.

Manual operation: See ["Starting Subframe \(SF\)"](#) on page 415

[:SOURCE<hw>]:BB:EUTRa:UL:UE<st>:NIOT:TRANs<ch>:REPetitions
 <Repetitions>

Sets the number of repetitions.

Parameters:

<Repetitions> R1 | R2 | R4 | R8 | R16 | R32 | R64 | R128
 *RST: R1

Example: See [Example"NPUSCH and NDRS configuration"](#) on page 810.

Manual operation: See ["Repetitions"](#) on page 416

[:SOURCE<hw>]:BB:EUTRa:UL:UE<st>:NIOT:TRANs<ch>:NRUNits
 <ResourceUnits>

Sets the number of allocated resource units.

Parameters:

<ResourceUnits> RU1 | RU2 | RU3 | RU4 | RU5 | RU6 | RU8 | RU10
 *RST: RU1

Example: See [Example"NPUSCH and NDRS configuration"](#) on page 810.

Manual operation: See ["Number of Resource Units N_{RU}"](#) on page 416

[:SOURCE<hw>]:BB:EUTRa:UL:UE<st>:NIOT:TRANS<ch>:SIRF
 <SCarrIndAckNack>

Sets the subcarrier indication field.

Parameters:

<SCarrIndAckNack> integer
 Range: 0 to 47
 *RST: 0

Example: See [Example"NPUSCH and NDRS configuration"](#) on page 810.

Manual operation: See ["Subcarrier Indication or ACK/NACK Resource Field"](#) on page 416

[:SOURCE<hw>]:BB:EUTRa:UL:UE<st>:NIOT:TRANS<ch>:NSCarriers?

Queries the allocated number of subcarriers.

Return values:

<NumSubcarriers> integer
 Range: 0 to 63
 *RST: 0

Example: See [Example"NPUSCH and NDRS configuration"](#) on page 810.

Usage: Query only

Manual operation: See ["Number of Subcarriers"](#) on page 417

[:SOURCE<hw>]:BB:EUTRa:UL:UE<st>:NIOT:TRANS<ch>:NSLTs?

Queries the allocated number of slots per RU.

Return values:

<NumSlots> integer
 Range: 1 to 16
 *RST: 0

Example: See [Example"NPUSCH and NDRS configuration"](#) on page 810.

Usage: Query only

Manual operation: See ["Slots"](#) on page 417

[[:SOURce<hw>]:BB:EUTRa:UL:UE<st>:NIOT:TRANs<ch>:STSCarrier?

Queries the starting subcarrier.

Return values:

<NbiotStartSc>	integer
Range:	0 to 1000
*RST:	0

Example: See [Example"NPUSCH and NDRS configuration"](#) on page 810.

Usage: Query only

Manual operation: See ["Starting Subcarrier"](#) on page 417

[[:SOURce<hw>]:BB:EUTRa:UL:UE<st>:NIOT:TRANs<ch>:STSlot?

Queries the starting slot.

Return values:

<StartSlot>	integer
Range:	0 to 2E5
*RST:	0

Example: See [Example"NPUSCH and NDRS configuration"](#) on page 810.

Usage: Query only

Manual operation: See ["Starting Slot"](#) on page 416

[[:SOURce<hw>]:BB:EUTRa:UL:UE<st>:NIOT:TRANs<ch>:POWER <Power>

Sets the power of the NPUSCH transmission.

Parameters:

<Power>	float
Range:	-80 to 10
Increment:	0.001
*RST:	0

Example: See [Example"NPUSCH and NDRS configuration"](#) on page 810.

Manual operation: See ["Power, dB"](#) on page 418

[[:SOURce<hw>]:BB:EUTRa:UL:UE<st>:NIOT:ARB:SUGGested?

Queries the ARB sequence length that is required for the selected NPUSCH transmissions.

Return values:

<NbiotSuggSeqLen>	integer
Range:	0 to 1E4
*RST:	0

Example: See [Example"NPUSCH and NDRS configuration"](#) on page 810.
Usage: Query only
Manual operation: See ["Suggested"](#) on page 418

[:SOURCE<hw>]:BB:EUTRa:UL:UE<st>:NIOT:NPSSim <NPuschAllSymb>

Enables simultaneous transmission of NPUSCH and SRS.

Parameters:

<NPuschAllSymb> 1 | ON | 0 | OFF

*RST: 1

Example: See [Example"NPUSCH and NDRS configuration"](#) on page 810.

Manual operation: See ["NPUSCH + SRS simultaneous Tx"](#) on page 262

[:SOURCE<hw>]:BB:EUTRa:UL:UE<st>:NIOT:TRANS<ch>:HARQ:BITS?

Queries the number of used ACK/NACK bits.

NPUSCH format F2 uses 1 ACK/NACK bit.

Return values:

<NbiotAnBits> integer

Range: 1 to 1

*RST: 0

Example: See [Example"NPUSCH and NDRS configuration"](#) on page 810.

Usage: Query only

Manual operation: See ["Number of A/N Bits"](#) on page 421

[:SOURCE<hw>]:BB:EUTRa:UL:UE<st>:NIOT:TRANS<ch>:HARQ:CBITS?

Queries the number of coded bits.

NPUSCH format F2 uses 16 coded bits.

Return values:

<NbiotCodANBits> integer

Range: 16 to 16

*RST: 0

Example: See [Example"NPUSCH and NDRS configuration"](#) on page 810.

Usage: Query only

Manual operation: See ["Number of Coded A/N Bits"](#) on page 421

[:SOURce<hw>]:BB:EUTRa:UL:UE<st>:NIOT:TRANs<ch>:HARQ:PATtern
 <NbiotANPat>, <BitCount>

Set the ACK/ANCK pattern.

Parameters:

<NbiotANPat> numeric
 *RST: #H0

<BitCount> integer
 Range: 1 to 1
 *RST: 1

Example: See [Example"NPUSCH and NDRS configuration"](#) on page 810.

Manual operation: See ["ACK/NACK Pattern"](#) on page 421

[:SOURce<hw>]:BB:EUTRa:UL:UE<st>:NIOT:TRANs<ch>:HARQ:SR
 <NbSchedulingReq>

If enabled, the SR symbols are block-wise multiplied with the C_{SR} sequence.

Parameters:

<NbSchedulingReq> 1 | ON | 0 | OFF
 *RST: 0

Example: See [Example"NPUSCH and NDRS configuration"](#) on page 810.

Options: R&S SMM-K146

Manual operation: See ["Scheduling Request \(SR\) Support"](#) on page 421

[:SOURce<hw>]:BB:EUTRa:UL:UE<st>:NIOT:TRANs<ch>:PUSCh:ESUPport
 <EdtSupport>

Enables or disables early data transmission.

Parameters:

<EdtSupport> 1 | ON | 0 | OFF
 *RST: 0

Example: See [Example"NPUSCH and NDRS configuration"](#) on page 810

Options: R&S SMM-K146

Manual operation: See ["Early Data Transmission \(EDT\) Support"](#) on page 420

[:SOURce<hw>]:BB:EUTRa:UL:UE<st>:NIOT:TRANs<ch>:PUSCh:ETBS <EdtTbs>

Sets the maximum transport block size for early data transmission in UL.

Parameters:

<EdtTbs> 88 | 328 | 408 | 504 | 584 | 680 | 808 | 936 | 1000
 *RST: 88
 Default unit: bit

Example: See [Example"NPUSCH and NDRS configuration"](#) on page 810

Options: R&S SMM-K146

Manual operation: See ["EDT-TBS"](#) on page 420

[:SOURCE<hw>]:BB:EUTRa:UL:UE<st>:NIOT:TRANs<ch>:PUSCh:ETRSIZE
 <EdtTranBlckSize>

Specifies the used transport block size for early data transmission in UL.

Parameters:

<EdtTranBlckSize> 88 | 328 | 408 | 456 | 504 | 536 | 584 | 680 | 712 | 776 | 808 |
 936 | 1000
 *RST: 88
 Default unit: bit

Example: See [Example"NPUSCH and NDRS configuration"](#) on page 810

Options: R&S SMM-K146

Manual operation: See ["EDT-TBS"](#) on page 420

[:SOURCE<hw>]:BB:EUTRa:UL:UE<st>:NIOT:TRANs<ch>:PUSCh:PHYSbits?

Queries the number of physical bits of the selected NPUSCH transmission.

Return values:

<NBiotPhysBits> integer
 Range: 1 to 1E5
 *RST: 0

Example: See [Example"NPUSCH and NDRS configuration"](#) on page 810.

Usage: Query only

Manual operation: See ["Total Number of Physical Bits"](#) on page 419

[:SOURCE<hw>]:BB:EUTRa:UL:UE<st>:NIOT:TRANs<ch>:PUSCh:RUIndex?

Queries the resource unit (RU) field index.

Return values:

<NbiotRuFind> integer
 Range: 1 to 16
 *RST: 0

Example: See [Example"NPUSCH and NDRS configuration"](#) on page 810.

Usage: Query only
Manual operation: See "[Resource Unit Field Index \$I_{RU}\$](#) " on page 419

[:SOURCE<hw>]:BB:EUTRa:UL:UE<st>:NIOT:TRANS<ch>:PUSCh:RVIndex
 <NbiotRVIdx>

Sets the starting redundancy version index.

Parameters:

<NbiotRVIdx> integer
 Range: 0 to 2
 *RST: 0

Example: See [Example"NPUSCH and NDRS configuration"](#) on page 810.

Manual operation: See "[Starting Redundancy Version Index \(rv_ix\)](#)" on page 420

[:SOURCE<hw>]:BB:EUTRa:UL:UE<st>:NIOT:TRANS<ch>:PUSCh:TBIndex
 <NbiotTBSIdx>

Sets the transport block size index.

Parameters:

<NbiotTBSIdx> integer
 Range: 0 to 12
 *RST: 0

Example: See [Example"NPUSCH and NDRS configuration"](#) on page 810.

Manual operation: See "[Transport Block Size Index \$I_{TBS}\$](#) " on page 420

[:SOURCE<hw>]:BB:EUTRa:UL:UE<st>:NIOT:TRANS<ch>:PUSCh:TBSize?

Queries the transport block size.

Return values:

<NbiotTBSize> integer
 Max transport block size depends on the installed options
 Option:R&S SMM-K115: Max = 1000
 Option:R&S SMM-K143: Max = 2536
 Range: 16 to max
 *RST: 0

Example: See [Example"NPUSCH and NDRS configuration"](#) on page 810.

Usage: Query only

Manual operation: See "[Transport Block Size/Payload](#)" on page 421

[:SOURce<hw>]:BB:EUTRa:UL:UE<st>:NIOT:FRC:TYPE <FrcID>

Selects the FRC.

Parameters:

<FrcID> A141 | A142 | A143 | A151 | A144 | A152 | A161 | A162 | A163 |
 A164 | A165 | A241 | A242 | A243 | A244 | A245 | A246 | A247
 *RST: A141

Example: See [Example"Using FRC"](#) on page 812.

Manual operation: See ["FRC"](#) on page 406

[:SOURce<hw>]:BB:EUTRa:UL:UE<st>:NIOT:FRC:STATE <State>

Enables the FRC.

Parameters:

<State> 1 | ON | 0 | OFF
 *RST: 0

Example: See [Example"Using FRC"](#) on page 812.

Manual operation: See ["FRC State"](#) on page 406

[:SOURce<hw>]:BB:EUTRa:UL:UE<st>:NIOT:FRC:ALResunits?

Queries the number of allocated resource units.

Return values:

<AllocResUnits> integer
 Range: 1 to 2
 *RST: 2

Example: See [Example"Using FRC"](#) on page 812.

Usage: Query only

Manual operation: See ["Allocated Resource Units"](#) on page 408

[:SOURce<hw>]:BB:EUTRa:UL:UE<st>:NIOT:FRC:BPResunit?

Queries the number of bits per resource unit.

Return values:

<BitsPerResUnit> integer
 Range: 96 to 288
 *RST: 96

Example: See [Example"Using FRC"](#) on page 812.

Usage: Query only

Manual operation: See ["Total Number of Bits per Resource Unit"](#) on page 408

[:SOURce<hw>]:BB:EUTRa:UL:UE<st>:NIOT:FRC:MODulation?

Queries the modulation scheme.

Return values:

<Modulation> QPSK | PI2Bpsk | PI4Qpsk
*RST: PI2Bpsk

Example: See [Example"Using FRC"](#) on page 812.

Usage: Query only

Manual operation: See ["Modulation"](#) on page 407

[:SOURce<hw>]:BB:EUTRa:UL:UE<st>:NIOT:FRC:NNPRep <NoNPUSCHRep>

Queries the number of NPUSCH repetitions.

Parameters:

<NoNPUSCHRep> 1 | 2 | 16 | 64
*RST: 1

Example: See [Example"Using FRC"](#) on page 812.

Manual operation: See ["Number of NPUSCH Repetitions"](#) on page 407

[:SOURce<hw>]:BB:EUTRa:UL:UE<st>:NIOT:FRC:NOSCarriers?

Queries the number of allocated subcarriers.

Return values:

<NoSubCarriers> integer
Range: 1 to 12
*RST: 1

Example: See [Example"Using FRC"](#) on page 812.

Usage: Query only

Manual operation: See ["Number of Allocated Subcarriers"](#) on page 407

[:SOURce<hw>]:BB:EUTRa:UL:UE<st>:NIOT:FRC:PASize?

Queries the payload size.

Return values:

<PayloadSize> integer
Range: 32 to 136
*RST: 32

Example: See [Example"Using FRC"](#) on page 812.

Usage: Query only

Manual operation: See ["Payload Size"](#) on page 407

[:SOURce<hw>]:BB:EUTRa:UL:UE<st>:NIOT:FRC:SCSPacing?

Queries the subcarrier spacing.

Return values:

<SubCarrSpacing> S15 | S375
*RST: S15

Example: See [Example"Using FRC"](#) on page 812.

Usage: Query only

Manual operation: See ["Subcarriers Spacing"](#) on page 407

[:SOURce<hw>]:BB:EUTRa:UL:UE<st>:NIOT:FRC:TBSSIndex?

Queries the transport block size index.

Return values:

<TBSSizeIndex> integer
Range: 0 to 9
*RST: 0

Example: See [Example"Using FRC"](#) on page 812.

Usage: Query only

Manual operation: See ["Transport Block Size Index I_{TBS}"](#) on page 407

[:SOURce<hw>]:BB:EUTRa:UL:UE<st>:PRACH:NIOT:MOD <Mode>

Selects the operating mode.

Parameters:

<Mode> INBD | ALON | GBD
*RST: INBD

Example: See [Example"NPRACH configuration"](#) on page 812.

Manual operation: See ["Mode"](#) on page 425

**[:SOURce<hw>]:BB:EUTRa:UL:UE<st>:PRACH:NIOT:PRATtempts
<PreambleAttempt>**

Sets the number of preamble attempts.

Parameters:

<PreambleAttempt> integer
Range: 0 to 30
*RST: 0

Example: See [Example"NPRACH configuration"](#) on page 812.

Manual operation: See ["Number of Preamble Attempts"](#) on page 426

[:SOURce<hw>]:BB:EUTRa:UL:UE<st>:PRACH:NIOT:RBID <RbIndex>

Sets the resource block in that the NPRACH is allocated.

Parameters:

<RbIndex> integer
 Range: 0 to 100
 *RST: 0

Example: See [Example"NPRACH configuration"](#) on page 812.

Manual operation: See ["Resource Block Index"](#) on page 425

[:SOURce<hw>]:BB:EUTRa:UL:UE<st>:PRACH:NIOT:DFReq <DeltaFreq>

Sets the frequency offset between the NB-IoT carrier and the LTE center frequency.

Parameters:

<DeltaFreq> float
 Range: -1E7 to 1E7
 Increment: 1000
 Default unit: MHz

Example: See [Example"NPRACH configuration"](#) on page 812.

Manual operation: See ["Delta Frequency to DC, MHz"](#) on page 426

**[:SOURce<hw>]:BB:EUTRa:UL:UE<st>:PRACH:ATT<ch0>:NIOT:CONFig
 <Configuration>**

Selects the NPRACH configuration.

Parameters:

<Configuration> integer
 Range: 0 to 2
 *RST: 0

Example: See [Example"NPRACH configuration"](#) on page 812.

Manual operation: See ["NPRACH Configuration"](#) on page 426

**[:SOURce<hw>]:BB:EUTRa:UL:UE<st>:PRACH:ATT<ch0>:NIOT:SFStart
 <StartingSf>**

Sets the starting subframe.

Parameters:

<StartingSf> integer
 Range: 0 to 1E4
 *RST: 8

Example: See [Example"NPRACH configuration"](#) on page 812.

Manual operation: See ["Starting Subframe"](#) on page 426

[:SOURce<hw>]:BB:EUTRa:UL:UE<st>:PRACH:ATT<ch0>:NIOT:INIT <Ninit>

Sets the subcarrier index.

Parameters:

<Ninit> integer
 Range: 0 to 47
 *RST: 0

Example: See [Example"NPRACH configuration"](#) on page 812.

Manual operation: See ["n_{int}"](#) on page 427

[:SOURce<hw>]:BB:EUTRa:UL:UE<st>:PRACH:ATT<ch0>:NIOT:STRT?

Queries the value n_{start} .

Return values:

<Nstart> integer
 Range: 0 to 47
 *RST: 0

Example: See [Example"NPRACH configuration"](#) on page 812.

Usage: Query only

Manual operation: See ["n_{start}"](#) on page 427

[:SOURce<hw>]:BB:EUTRa:UL:UE<st>:PRACH:ATT<ch0>:NIOT:POWER <Power>

Sets the preamble attempt power relative to the UE power.

Parameters:

<Power> float
 Range: -80.000 to 10.000
 Increment: 0.001
 *RST: 0

Example: See [Example"NPRACH configuration"](#) on page 812.

Manual operation: See ["Power"](#) on page 427

[:SOURce<hw>]:BB:EUTRa:UL:UE<st>:PRACH:NIOT:ARB:SUGGested?

Queries the ARB sequence length that is required for the selected NPRACH transmissions.

Return values:

<PracNbiotSugg> integer
 Range: 0 to 1E4
 *RST: 0

Example: See [Example"NPRACH configuration"](#) on page 812.

Usage: Query only

Manual operation: See ["ARB Sequece Length > Sugested"](#) on page 427

[:SOURce<hw>]:BB:EUTRa:UL:UE<st>:NIOT:FRC:TYPE <FrcID>

Selects the FRC.

Parameters:

<FrcID> A141 | A142 | A143 | A151 | A144 | A152 | A161 | A162 | A163 |
 A164 | A165 | A241 | A242 | A243 | A244 | A245 | A246 | A247
 *RST: A141

Example: See [Example"Using FRC"](#) on page 812.

Manual operation: See ["FRC"](#) on page 406

[:SOURce<hw>]:BB:EUTRa:UL:UE<st>:NIOT:FRC:STATE <State>

Enables the FRC.

Parameters:

<State> 1 | ON | 0 | OFF
 *RST: 0

Example: See [Example"Using FRC"](#) on page 812.

Manual operation: See ["FRC State"](#) on page 406

[:SOURce<hw>]:BB:EUTRa:UL:UE<st>:NIOT:FRC:ALResunits?

Queries the number of allocated resource units.

Return values:

<AllocResUnits> integer
 Range: 1 to 2
 *RST: 2

Example: See [Example"Using FRC"](#) on page 812.

Usage: Query only

Manual operation: See ["Allocated Resource Units"](#) on page 408

[:SOURCE<hw>]:BB:EUTRa:UL:UE<st>:NIOT:FRC:MODulation?

Queries the modulation scheme.

Return values:

<Modulation> QPSK | PI2Bpsk | PI4Qpsk
*RST: PI2Bpsk

Example: See [Example"Using FRC"](#) on page 812.

Usage: Query only

Manual operation: See ["Modulation"](#) on page 407

[:SOURCE<hw>]:BB:EUTRa:UL:UE<st>:NIOT:FRC:PASize?

Queries the payload size.

Return values:

<PayloadSize> integer
Range: 32 to 136
*RST: 32

Example: See [Example"Using FRC"](#) on page 812.

Usage: Query only

Manual operation: See ["Payload Size"](#) on page 407

[:SOURCE<hw>]:BB:EUTRa:UL:UE<st>:NIOT:FRC:TBSSindex?

Queries the transport block size index.

Return values:

<TBSSizeIndex> integer
Range: 0 to 9
*RST: 0

Example: See [Example"Using FRC"](#) on page 812.

Usage: Query only

Manual operation: See ["Transport Block Size Index I_{TBS}"](#) on page 407

[:SOURCE<hw>]:BB:EUTRa:UL:UE<st>:NIOT:FRC:SCSPacing?

Queries the subcarrier spacing.

Return values:

<SubCarrSpacing> S15 | S375
*RST: S15

Example: See [Example"Using FRC"](#) on page 812.

Usage: Query only

Manual operation: See ["Subcarriers Spacing"](#) on page 407

[:SOURCE<hw>]:BB:EUTRa:UL:UE<st>:NIOT:FRC:PASize?

Queries the payload size.

Return values:

<PayloadSize> integer
 Range: 32 to 136
 *RST: 32

Example: See [Example"Using FRC"](#) on page 812.

Usage: Query only

Manual operation: See ["Payload Size"](#) on page 407

[:SOURCE<hw>]:BB:EUTRa:UL:UE<st>:NIOT:FRC:NOSCarriers?

Queries the number of allocated subcarriers.

Return values:

<NoSubCarriers> integer
 Range: 1 to 12
 *RST: 1

Example: See [Example"Using FRC"](#) on page 812.

Usage: Query only

Manual operation: See ["Number of Allocated Subcarriers"](#) on page 407

[:SOURCE<hw>]:BB:EUTRa:UL:UE<st>:NIOT:FRC:NNPRep <NoNPUSCHRep>

Queries the number of NPUSCH repetitions.

Parameters:

<NoNPUSCHRep> 1 | 2 | 16 | 64
 *RST: 1

Example: See [Example"Using FRC"](#) on page 812.

Manual operation: See ["Number of NPUSCH Repetitions"](#) on page 407

[:SOURCE<hw>]:BB:EUTRa:UL:UE<st>:NIOT:FRC:BPResunit?

Queries the number of bits per resource unit.

Return values:

<BitsPerResUnit> integer
 Range: 96 to 288
 *RST: 96

- Example:** See [Example"Using FRC"](#) on page 812.
- Usage:** Query only
- Manual operation:** See ["Total Number of Bits per Resource Unit"](#) on page 408

[:SOURce<hw>]:BB:EUTRa:UL:UE<st>:EMTC:CELevel <CeLevel>

Set the coverage extension level (CE).

Parameters:

<CeLevel> CE01 | CE23
*RST: CE01

Example: See [Example"eMTC PUSCH configuration"](#) on page 820.

Manual operation: See ["CE Level"](#) on page 461

[:SOURce<hw>]:BB:EUTRa:UL:UE<st>:EMTC:HOPP <HoppingInterval>

Sets the narrowband hopping interval.

Parameters:

<HoppingInterval> H1 | H2 | H4 | H5 | H8 | H10 | H16 | H20 | H40
*RST: 1

Example: See [Example"eMTC PUSCH configuration"](#) on page 820.

Manual operation: See ["Narrowband Hopping Interval"](#) on page 462

[:SOURce<hw>]:BB:EUTRa:UL:UE<st>:EMTC:NTRansmiss <NumTransmission>

Sets the number of PUSCH and PUCCH eMTC transmission for the selected UE.

Parameters:

<NumTransmission> integer
Range: 1 to 20
*RST: 1

Example: See [Example"eMTC PUSCH configuration"](#) on page 820.

Manual operation: See ["Number of Transmissions"](#) on page 462

**[:SOURce<hw>]:BB:EUTRa:UL:UE<st>:EMTC:TRANs<ch>:CONTent
<ContentType>**

Sets the channel type.

Parameters:

<ContentType> PUSCh | PUCCh
*RST: PUSCh

Example: See [Example"eMTC PUSCH configuration"](#) on page 820.

Manual operation: See ["Content"](#) on page 462

[:SOURCE<hw>]:BB:EUTRa:UL:UE<st>:EMTC:TRANS<ch>:MODulation
<Modulation>

Sets the modulation scheme of the PUSCH transmission.

Parameters:

<Modulation> QPSK | QAM16 | QAM64
*RST: QPSK

Example: See [Example"eMTC PUSCH configuration"](#) on page 820.

Manual operation: See ["Modulation/Format"](#) on page 462

[:SOURCE<hw>]:BB:EUTRa:UL:UE<st>:EMTC:TRANS<ch>:FORMat <Format>

Sets the PUCCH format.

Parameters:

<Format> F1 | F1A | F1B | F2 | F2A | F2B
*RST: F1

Example: See [Example"eMTC PUCCH configuration"](#) on page 822.

Manual operation: See ["Modulation/Format"](#) on page 462
See ["Format"](#) on page 475

[:SOURCE<hw>]:BB:EUTRa:UL:UE<st>:EMTC:TRANS<ch>:STSFrame
<StartSubframe>

Sets the subframe number in that the PUSCH/PUCCH allocation is scheduled for the first time.

Parameters:

<StartSubframe> integer
Range: 0 to 10000
*RST: 0

Example: See [Example"eMTC PUSCH configuration"](#) on page 820.

Manual operation: See ["Start Subframe"](#) on page 463

[:SOURCE<hw>]:BB:EUTRa:UL:UE<st>:EMTC:TRANS<ch>:ASFFrame?

Queries the number of absolute subframes.

Return values:

<NumAbsSubframe> integer
Range: 1 to 10000
*RST: 1

- Example:** See [Example "eMTC PUSCH configuration"](#) on page 820.
- Usage:** Query only
- Manual operation:** See ["No. Absolute Subframes"](#) on page 464

[:SOURce<hw>]:BB:EUTRa:UL:UE<st>:EMTC:TRANs<ch>:REPetitions
 <Repetitions>

Sets the number of repetitions.

Parameters:

<Repetitions> R1 | R2 | R4 | R8 | R16 | R32 | R64 | R128 | R192 | R256 |
 R384 | R512 | R768 | R1024 | R1536 | R2048 | R12 | R24
 *RST: 1

- Example:** See [Example "eMTC PUSCH configuration"](#) on page 820.
- Manual operation:** See ["Repetitions"](#) on page 463

[:SOURce<hw>]:BB:EUTRa:UL:UE<st>:EMTC:TRANs<ch>:STNBand
 <StartNarrowBand>

Sets the start NB of the PSUCH/PUCCH transmission.

Parameters:

<StartNarrowBand> integer
 Range: 0 to number of available narrowbands
 *RST: 0

- Example:** See [Example "eMTC PUSCH configuration"](#) on page 820.
- Manual operation:** See ["Start Narrowband"](#) on page 464

[:SOURce<hw>]:BB:EUTRa:UL:UE<st>:EMTC:TRANs<ch>:NRBLoCks
 <NumberResBlocks>

Sets the number of used resource blocks (RB) within one narrowband.

Parameters:

<NumberResBlocks> integer
 Range: 1 to 6
 *RST: 1

- Example:** See [Example "eMTC PUSCH configuration"](#) on page 820.
- Manual operation:** See ["No. RB"](#) on page 464

[:SOURce<hw>]:BB:EUTRa:UL:UE<st>:EMTC:TRANs<ch>:RBOFfset
 <ResBlockOffset>

For allocations that span less than 6 RB, this parameter shifts the allocated RBs within the NB.

Parameters:

<ResBlockOffset> integer
 Range: 0 to 5
 *RST: 0

Example: See [Example "eMTC PUSCH configuration"](#) on page 820.

Manual operation: See ["Offset VRB"](#) on page 465

[:SOURCE<hw>]:BB:EUTRa:UL:UE<st>:EMTC:TRANS<ch>:STWBand
 <StartWideBand>

Sets the first wideband used for the PSUCH/PUCCH transmission.

Parameters:

<StartWideBand> integer
 *RST: 1

Example: See [Example "eMTC widebands configuration"](#) on page 814.

Options: R&S SMM-K143

Manual operation: See ["Start Wideband"](#) on page 465

[:SOURCE<hw>]:BB:EUTRa:UL:UE<st>:EMTC:TRANS<ch>:WBRBoffset
 <WideBandRBOffs>

Shifts the selected number of resource blocks within the wideband.

Parameters:

<WideBandRBOffs> OS0 | OS3 | OS6 | OS9 | OS12 | OS15 | OS18 | OS21

Example: See [Example "eMTC widebands configuration"](#) on page 814.

Options: R&S SMM-K143

Manual operation: See ["Offset VRB"](#) on page 465

[:SOURCE<hw>]:BB:EUTRa:UL:UE<st>:EMTC:TRANS<ch>:WRBLocks
 <NumberRBWB>

Sets the number of used resource blocks (RB) within one wideband.

Parameters:

<NumberRBWB> CN3 | CN6 | CN9 | CN12 | CN15 | CN18 | CN21 | CN24
 *RST: CN3

Example: See [Example "eMTC widebands configuration"](#) on page 814.

Options: R&S SMM-K143

Manual operation: See ["No. RB"](#) on page 465

[[:SOURce<hw>]:BB:EUTRa:UL:UE<st>:EMTC:TRANs<ch>:POWer <Power>

Sets the power of the eMTC PUSCH and PUCCH transmission

Parameters:

<Power> float
 Range: -80 to 10
 Increment: 0.001
 *RST: 0

Example: See [Example "eMTC PUSCH configuration"](#) on page 820.

Manual operation: See ["Power, dB"](#) on page 465

[[:SOURce<hw>]:BB:EUTRa:UL:UE<st>:EMTC:ARB:SUGGested?

Queries the ARB sequence length that is required for the selected PUSCH transmissions.

Return values:

<Suggested> integer
 Range: 0 to 10000
 *RST: 0

Example: See [Example "eMTC PUSCH configuration"](#) on page 820.

Usage: Query only

Manual operation: See ["Suggested"](#) on page 418

[[:SOURce<hw>]:BB:EUTRa:UL:UE<st>:EMTC:TRANs<ch>:DRS:CYCShift?

Sets the cyclic shift field.

Return values:

<Cyclicshift> integer
 Range: 0 to 7
 *RST: 0

Example: See [Example "eMTC PUSCH configuration"](#) on page 820.

Usage: Query only

Manual operation: See ["Cyclic Shift Filed"](#) on page 467

[[:SOURce<hw>]:BB:EUTRa:UL:UE<st>:EMTC:TRANs<ch>:NDMRs?

Queries the parameter $n(2)_{\text{DMRS},\lambda}$ (Layer λ).

Return values:

<Ndmrs> integer
 Range: 0 to 10
 *RST: 0

- Example:** See [Example"eMTC PUSCH configuration"](#) on page 820.
- Usage:** Query only
- Manual operation:** See ["n\(2\)_DMRS,0 \(Layer 0\)"](#) on page 467

[:SOURce<hw>]:BB:EUTRa:UL:UE<st>:EMTC:TRANS<ch>:PUSCh:CQI:BITS
 <NumCQIBits>

Sets the number of CQI bits before channel coding.

Parameters:

<NumCQIBits> integer
 Range: 0 to 1024
 *RST: 10

- Example:** See [Example"eMTC PUCCH configuration"](#) on page 822.
- Manual operation:** See ["Number of CQI Bits"](#) on page 469

[:SOURce<hw>]:BB:EUTRa:UL:UE<st>:EMTC:TRANS<ch>:PUSCh:CQI:PATTERN
 <EmtcCqiPat>, <BitCount>

Sets the CQI pattern for the PUSCH.

The length of the pattern is determined by the number of CQI bits as set with the command [\[:SOURce<hw>\]:BB:EUTRa:UL:UE<st>:EMTC:TRANS<ch>:PUSCh:CQI:BITS](#).

Parameters:

<EmtcCqiPat> numeric
 *RST: #H0

<BitCount> integer
 Range: 1 to 1024
 *RST: 1

- Example:** See [Example"eMTC PUSCH configuration"](#) on page 820.
- Manual operation:** See ["CQI Pattern"](#) on page 469

[:SOURce<hw>]:BB:EUTRa:UL:UE<st>:EMTC:TRANS<ch>:PUSCh:CQI:CBITs?

Queries the number of coded CQI bits.

Return values:

<NumCodedCQIBits> integer
 Range: 0 to 1E5
 *RST: 20

- Example:** See [Example"eMTC PUSCH configuration"](#) on page 820.
- Usage:** Query only

Manual operation: See ["Number of Coded CQI Bits"](#) on page 469

[:SOURCE<hw>]:BB:EUTRa:UL:UE<st>:EMTC:TRANs<ch>:HARQ:MODE <Mode>

Sets the ACK/NACK mode.

Parameters:

<Mode> MUX
*RST: MUX

Example: See [Example"eMTC PUSCH configuration"](#) on page 820.

Manual operation: See ["ACK/NACK Mode"](#) on page 468

[:SOURCE<hw>]:BB:EUTRa:UL:UE<st>:EMTC:TRANs<ch>:ULSCH:BITS?

Queries the number of physical bits used for UL-SCH transmission.

Return values:

<PhysBitULSCH> integer
Range: 0 to 1E5
*RST: 1500

Example: See [Example"eMTC PUSCH configuration"](#) on page 820.

Usage: Query only

Manual operation: See ["Number of Coded UL-SCH Bits"](#) on page 470

**[:SOURCE<hw>]:BB:EUTRa:UL:UE<st>:EMTC:TRANs<ch>:CCODing:TBSIZE
<TranspBlockSize>**

Sets the size of the transport block.

Parameters:

<TranspBlockSize> integer
Range: 1 to 1E5
*RST: 16

Example: See [Example"eMTC PUSCH configuration"](#) on page 820.

Manual operation: See ["Transport Block Size/Payload"](#) on page 470

[:SOURCE<hw>]:BB:EUTRa:UL:UE<st>:EMTC:TRANs<ch>:NAPused?

Queries the number of antenna ports used for transmissions of the selected PUCCH format.

Return values:

<NumAntennaPorts> integer
Range: 1 to 1
*RST: 1

- Example:** See [Example "eMTC PUCCH configuration"](#) on page 822.
- Usage:** Query only
- Manual operation:** See ["Number of Used Antenna Port"](#) on page 475

[:SOURce<hw>]:BB:EUTRa:UL:UE<st>:EMTC:TRANS<ch>:NPUCch
 <NPucchAP100>

Sets the PUCCH resource index.

Parameters:

<NPucchAP100> integer
 Range: 0 to 65535
 *RST: 0

- Example:** See [Example "eMTC PUCCH configuration"](#) on page 822.
- Manual operation:** See ["n_PUCCH Antenna Port 100"](#) on page 476

[:SOURce<hw>]:BB:EUTRa:UL:UE<st>:EMTC:TRANS<ch>:HARQ:BITS <Bits>

Sets the number of ACK/NACK bits.

Parameters:

<Bits> integer
 Range: 0 to 20
 *RST: 1

- Example:** See [Example "eMTC PUSCH configuration"](#) on page 820.
- Manual operation:** See ["Number of A/N Bits"](#) on page 468

[:SOURce<hw>]:BB:EUTRa:UL:UE<st>:EMTC:TRANS<ch>:HARQ:CBITs?

Queries the number of coded ACK/NACK bits.

Return values:

<Codedbits> integer
 Range: 0 to 1E5
 *RST: 20

- Example:** See [Example "eMTC PUSCH configuration"](#) on page 820.
- Usage:** Query only
- Manual operation:** See ["Number of Coded A/N Bits"](#) on page 469

[:SOURce<hw>]:BB:EUTRa:UL:UE<st>:EMTC:TRANS<ch>:HARQ:PATtern
 <EmtcAckNackPat>, <BitCount>

Sets the ACK/NACK pattern for the PUSCH.

Parameters:

<EmtcAckNackPat> numeric
 *RST: #H0

<BitCount> integer
 Range: 1 to 64
 *RST: 1

Example: See [Example"eMTC PUSCH configuration"](#) on page 820.

Manual operation: See ["ACK/NACK Pattern"](#) on page 468

[:SOURCE<hw>]:BB:EUTRa:UL:UE<st>:EMTC:TRANs<ch>:PHYSbits?

Queries the number of physical bits of the selected PUSCH transmission.

Return values:

<PuscPhysBits> integer
 Range: 1 to 1E5
 *RST: 0

Example: See [Example"eMTC PUSCH configuration"](#) on page 820.

Usage: Query only

Manual operation: See ["Total Number of Physical Bits"](#) on page 470

[:SOURCE<hw>]:BB:EUTRa:UL:UE<st>:EMTC:TRANs<ch>:CCODing:RVIndex <RedundVersIndex>

Sets the redundancy version index.

Parameters:

<RedundVersIndex> integer
 Range: 0 to 3
 *RST: 0

Example: See [Example"eMTC PUSCH configuration"](#) on page 820.

Manual operation: See ["Starting Redundancy Version Index \(rv_idx\)"](#) on page 470

[:SOURCE<hw>]:BB:EUTRa:UL:UE<st>:EMTC:TRANs<ch>:PUCCh:HARQ: PATTERN <EmtcAckNackPat>, <BitCount>

Sets the PUCCH ACK/NACK pattern.

Parameters:

<EmtcAckNackPat> numeric
 *RST: #H0

<BitCount> integer
 Range: 1 to 64
 *RST: 1

Example: See [Example"eMTC PUCCH configuration"](#) on page 822.

Manual operation: See ["A/N Pattern"](#) on page 476

[:SOURCE<hw>]:BB:EUTRa:UL:UE<st>:EMTC:TRANS<ch>:PUCCh:CQI:BITS
<NumCQIBits>

Sets the number of CQI bits before channel coding.

Parameters:

<NumCQIBits> integer
Range: 0 to 1024
*RST: 10

Example: See [Example"eMTC PUCCH configuration"](#) on page 822.

Manual operation: See ["Number of CQI Bits"](#) on page 476

[:SOURCE<hw>]:BB:EUTRa:UL:UE<st>:EMTC:TRANS<ch>:PUCCh:CQI:PATtern
<Pattern>, <BitCount>

Sets the CQI pattern for the PUCCH.

Parameters:

<Pattern> numeric
*RST: #H0
<BitCount> integer
Range: 1 to 13
*RST: 1

Example: See [Example"eMTC PUCCH configuration"](#) on page 822.

Manual operation: See ["CQI Pattern"](#) on page 476

[:SOURCE<hw>]:BB:EUTRa:UL:UE<st>:EMTC:TRANS<ch>:PUCCh:CQI:CBITS?

Queries the number of coded CQI bits.

Return values:

<NumCodedCQIBits> integer
Range: 0 to 1E5
*RST: 20

Example: See [Example"eMTC PUCCH configuration"](#) on page 822.

Usage: Query only

Manual operation: See ["Number of Coded CQI Bits"](#) on page 476

[:SOURce<hw>]:BB:EUTRa:UL:UE<st>:PRACH:EMTC:PRATtempts
 <PreambleAttempt>

Sets the number of preamble attempts.

Parameters:

<PreambleAttempt> integer
 Range: 0 to 40
 *RST: 0

Example: See [Example "eMTC PRACH configuration"](#) on page 822.

Manual operation: See ["Number of Preamble Attempts"](#) on page 480

[:SOURce<hw>]:BB:EUTRa:UL:UE<st>:PRACH:ATT<ch0>:EMTC:CELV <CeLevel>

Sets the CE level.

Parameters:

<CeLevel> integer
 Range: 0 to 3
 *RST: 0

Example: See [Example "eMTC PRACH configuration"](#) on page 822.

Manual operation: See ["CE Level"](#) on page 480

[:SOURce<hw>]:BB:EUTRa:UL:UE<st>:PRACH:ATT<ch0>:EMTC:SFStart
 <StartingSf>

Sets the starting subframe.

Parameters:

<StartingSf> integer
 Range: 0 to 1E5
 *RST: 1

Example: See [Example "eMTC PRACH configuration"](#) on page 822.

Manual operation: See ["Starting Subframe"](#) on page 481

[:SOURce<hw>]:BB:EUTRa:UL:UE<st>:PRACH:ATT<ch0>:EMTC:FRIndex
 <FreqResIndex>

For "Duplexing > TDD", sets the frequency resource index.

Parameters:

<FreqResIndex> integer
 Range: 0 to 1E5
 *RST: 0

Example:

SOURce1:BB:EUTRa:DUPLexing TDD
 SOURce1:BB:EUTRa:UL:UE2:PRACH:ATT0:EMTC:FRIndex 10

Manual operation: See ["Frequency Resource Index"](#) on page 481

[:SOURCE<hw>]:BB:EUTRa:UL:UE<st>:PRACH:ATT<ch0>:EMTC:NCSConf
 <NcsConfig>

Selects the Ncs configuration.

Parameters:

<NcsConfig> integer
 For detail on the value range, see [Table 5-50](#).
 Range: 0 to 15
 *RST: 0

Example: See [Example "eMTC PRACH configuration"](#) on page 822.

Manual operation: See ["Ncs Configuration"](#) on page 481

[:SOURCE<hw>]:BB:EUTRa:UL:UE<st>:PRACH:ATT<ch0>:EMTC:RSEquence
 <RootSequence>

Sets the logical root sequence index.

Parameters:

<RootSequence> integer
 Range: 0 to 838
 *RST: 0

Example: See [Example "eMTC PRACH configuration"](#) on page 822.

Manual operation: See ["Logical Root Sequence Index"](#) on page 481

[:SOURCE<hw>]:BB:EUTRa:UL:UE<st>:PRACH:ATT<ch0>:EMTC:SINdex
 <SequenceIndex>

Sets the sequence index *v*.

Parameters:

<SequenceIndex> integer
 Range: 0 to 63
 *RST: 0

Example: See [Example "eMTC PRACH configuration"](#) on page 822.

Manual operation: See ["Sequence Index \(v\)"](#) on page 482

[:SOURCE<hw>]:BB:EUTRa:UL:UE<st>:PRACH:ATT<ch0>:EMTC:DT <DeltaTime>

Sets the parameter Delta_t in us.

Parameters:

<DeltaTime> float
 Range: -500 to 500
 Increment: 0.01
 *RST: 0

Example: See [Example"eMTC PRACH configuration"](#) on page 822.

Manual operation: See ["Delta t /us"](#) on page 482

[:SOURce<hw>]:BB:EUTRa:UL:UE<st>:PRACH:ATT<ch0>:EMTC:POWer <Power>

Sets the preamble attempt power relative to the UE power.

Parameters:

<Power> float
 Range: -80.000 to 10.000
 Increment: 0.001
 *RST: 0

Example: See [Example"eMTC PRACH configuration"](#) on page 822.

Manual operation: See ["Power, dB"](#) on page 482

[:SOURce<hw>]:BB:EUTRa:UL:UE<st>:PRACH:EMTC:ARB:SUGGested?

Queries the ARB sequence length that is required for the PRACH configuration.

Return values:

<Suggested> integer
 Range: 0 to 10000
 *RST: 0

Example: See [Example"eMTC PRACH configuration"](#) on page 822.

Usage: Query only

Manual operation: See ["ARB Sequece Length > Sugested"](#) on page 482

10.28 Test case wizard remote-control commands

The signal generator gives you the opportunity to generate predefined settings which enable tests on base stations in conformance with the 3G standard EUTRA/LTE. It offers a selection of predefined settings according to Test Cases in TS 36.141. The settings take effect only after execution of command `[:SOURce<hw>] :BB:EUTRa:TCW:APPLysettings`.

<code>[:SOURce<hw>]:BB:EUTRa:TCW:APPLysettings</code>	933
<code>[:SOURce<hw>]:BB:EUTRa:TCW:AWGN:PLEVel?</code>	934
<code>[:SOURce<hw>]:BB:EUTRa:TCW:FA:FRALlocation</code>	934
<code>[:SOURce<hw>]:BB:EUTRa:TCW:FA:RBALlocation</code>	934

Test case wizard remote-control commands

[SOURce<hw>]:BB:EUTRa:TCW:GS:SPEC.....	934
[SOURce<hw>]:BB:EUTRa:TCW:GS:RELease.....	934
[SOURce<hw>]:BB:EUTRa:TCW:GS:MARKErconfig.....	935
[SOURce<hw>]:BB:EUTRa:TCW:GS:BSCLeass.....	935
[SOURce<hw>]:BB:EUTRa:TCW:GS:SIGRout.....	935
[SOURce<hw>]:BB:EUTRa:TCW:GS:TRIGgerconfig.....	936
[SOURce<hw>]:BB:EUTRa:TCW:IS2:CHBW?.....	936
[SOURce<hw>]:BB:EUTRa:TCW:IS:CHBW?.....	936
[SOURce<hw>]:BB:EUTRa:TCW:IS:CLID.....	936
[SOURce<hw>]:BB:EUTRa:TCW:IS2:DUPLex.....	936
[SOURce<hw>]:BB:EUTRa:TCW:IS:DUPLex.....	936
[SOURce<hw>]:BB:EUTRa:TCW:IS2:IFTYpe?.....	937
[SOURce<hw>]:BB:EUTRa:TCW:IS:IFTYpe.....	937
[SOURce<hw>]:BB:EUTRa:TCW:IS:NRBLock?.....	937
[SOURce<hw>]:BB:EUTRa:TCW:IS:NTAOffset.....	937
[SOURce<hw>]:BB:EUTRa:TCW:IS:OCEDge.....	937
[SOURce<hw>]:BB:EUTRa:TCW:IS:OVRB?.....	938
[SOURce<hw>]:BB:EUTRa:TCW:IS2:PLEVel?.....	938
[SOURce<hw>]:BB:EUTRa:TCW:IS3:PLEVel?.....	938
[SOURce<hw>]:BB:EUTRa:TCW:IS:PLEVel?.....	938
[SOURce<hw>]:BB:EUTRa:TCW:IS2:RFFRequency.....	938
[SOURce<hw>]:BB:EUTRa:TCW:IS:RFFRequency.....	938
[SOURce<hw>]:BB:EUTRa:TCW:IS:TDDConfig.....	938
[SOURce<hw>]:BB:EUTRa:TCW:IS:TMODeL?.....	939
[SOURce<hw>]:BB:EUTRa:TCW:IS:UEID.....	939
[SOURce<hw>]:BB:EUTRa:TCW:TC.....	939
[SOURce<hw>]:BB:EUTRa:TCW:WS:CHBW.....	940
[SOURce<hw>]:BB:EUTRa:TCW:WS:CLID.....	940
[SOURce<hw>]:BB:EUTRa:TCW:WS:CYCPrefix.....	940
[SOURce<hw>]:BB:EUTRa:TCW:WS:DUPLex.....	940
[SOURce<hw>]:BB:EUTRa:TCW:WS:FRC.....	940
[SOURce<hw>]:BB:EUTRa:TCW:WS:NTAOffset.....	941
[SOURce<hw>]:BB:EUTRa:TCW:WS:OUPLevel.....	941
[SOURce<hw>]:BB:EUTRa:TCW:MUE:OVRB.....	941
[SOURce<hw>]:BB:EUTRa:TCW:SUE:OVRB.....	941
[SOURce<hw>]:BB:EUTRa:TCW:WS:OVRB.....	941
[SOURce<hw>]:BB:EUTRa:TCW:WS:PLEVel?.....	941
[SOURce<hw>]:BB:EUTRa:TCW:WS:RFFRequency.....	942
[SOURce<hw>]:BB:EUTRa:TCW:WS:TDDConfig.....	942
[SOURce<hw>]:BB:EUTRa:TCW:MUE:UEID.....	942
[SOURce<hw>]:BB:EUTRa:TCW:SUE:UEID.....	942
[SOURce<hw>]:BB:EUTRa:TCW:WS:UEID.....	942

[SOURce<hw>]:BB:EUTRa:TCW:APPLysettings

Activates the current settings of the test case wizard.

Note: The settings of the selected test case become active only after executing this command.

Usage: Event

Manual operation: See ["Apply Settings"](#) on page 508

[:SOURCE<hw>]:BB:EUTRa:TCW:AWGN:PLEVel?

Queries the AWGN power level.

Return values:

<PowerLevel> string

Usage: Query only

Manual operation: See ["Power Level"](#) on page 524

[:SOURCE<hw>]:BB:EUTRa:TCW:FA:FRAllocation <FrequencyAlloc>

[:SOURCE<hw>]:BB:EUTRa:TCW:FA:RBAllocation <ResBlockAlloc>

Determines the frequency position of the wanted and interfering signal.

Parameters:

<ResBlockAlloc> HIGHer | LOWer
*RST: HIGHer

Manual operation: See ["Frequency Allocation of the Interfering signal"](#) on page 505

[:SOURCE<hw>]:BB:EUTRa:TCW:GS:SPEC <GsSpec>

Selects the 3GPP test specification used as a guideline for the test cases.

Parameters:

<GsSpec> TS36141
*RST: TS36141

Example: SOURCE1:BB:EUTRa:TCW:GS:SPEC TS36141

Manual operation: See ["Test Specification"](#) on page 502

[:SOURCE<hw>]:BB:EUTRa:TCW:GS:RELease <Release>

Sets the 3GPP test specification used as a guideline for the test cases.

Parameters:

<Release> REL8 | REL9 | REL10 | REL11
*RST: REL8

Manual operation: See ["Release"](#) on page 503

[:SOURCE<hw>]:BB:EUTRa:TCW:GS:MARKerconfig <MarkerConfig>

Selects the marker configuration. The marker can be used to synchronize the measuring equipment to the signal generator.

Parameters:

<MarkerConfig> UNCHanged | FRAME

FRAME

The marker settings are customized for the selected test case. "Radio Frame Start" markers are output; the marker delays are set equal to zero.

UNCHanged

The current marker settings of the signal generator are retained unchanged.

*RST: FRAME

Manual operation: See "[Marker Configuration](#)" on page 504

[:SOURCE<hw>]:BB:EUTRa:TCW:GS:BSCLass <BsClass>

Sets the base station class.

Parameters:

<BsClass> WIDE | LOCAL | HOME | MEDIUM

*RST: WIDE

Example:

```
SOURCE1:BB:EUTRa:TCW:GS:RELease REL10
SOURCE1:BB:EUTRa:TCW:TC TS36141_TC72
SOURCE1:BB:EUTRa:TCW:GS:BSCLass LOCAL
SOURCE1:BB:EUTRa:TCW:WS:PLevel?
Response: "-98.10 dBm"
```

Manual operation: See "[Base Station Class](#)" on page 503

[:SOURCE<hw>]:BB:EUTRa:TCW:GS:SIGRout <SignalRouting>

Selects the signal routing for baseband A signal which usually represents the wanted signal.

Parameters:

<SignalRouting> PORTA

*RST: PORTA

Example:

```
SOURCE1:BB:EUTRa:TCW:GS:SIGRout PORTA
```

[:SOURce<hw>]:BB:EUTRa:TCW:GS:TRIGgerconfig <TriggerConfig>

Selects the trigger configuration. The trigger is used to synchronize the signal generator to the other equipment.

Parameters:

<TriggerConfig> UNCHanged | AAUTo

UNCHanged

The current trigger settings of the signal generator are retained unchanged.

AAUTo

The trigger settings are customized for the selected test case. The trigger setting "Armed Auto" with external trigger source is used; the trigger delay is set to zero. Thus, the base station frame timing is able to synchronize the signal generator by a periodic trigger.

*RST: AAUTo

Manual operation: See "[Trigger Configuration](#)" on page 504

[:SOURce<hw>]:BB:EUTRa:TCW:IS2:CHBW?

[:SOURce<hw>]:BB:EUTRa:TCW:IS:CHBW?

Queries the channel bandwidth of the interfering signal in MHz: 20, 10, 5, 3, 1.4, 15, or 0.2 MHz.

Return values:

<ChanBandwidth> BW20_00 | BW10_00 | BW5_00 | BW3_00 | BW1_40 |
BW15_00 | BW00_20

Usage: Query only

Manual operation: See "[Channel Bandwidth](#)" on page 514
See "[Channel Bandwidth](#)" on page 520

[:SOURce<hw>]:BB:EUTRa:TCW:IS:CLID <CellID>

Sets the Cell ID for the interfering signal.

Parameters:

<CellID> integer
Range: 0 to 503
*RST: 1

Manual operation: See "[Cell ID](#)" on page 521

[:SOURce<hw>]:BB:EUTRa:TCW:IS2:DUPLex <Duplexing>

[:SOURce<hw>]:BB:EUTRa:TCW:IS:DUPLex <Duplex>

Selects whether TDD or FDD duplexing mode is used.

Parameters:

<Duplex> TDD | FDD
 *RST: FDD

Manual operation: See ["Duplexing"](#) on page 514
 See ["Duplexing"](#) on page 520

[:SOURCE<hw>]:BB:EUTRa:TCW:IS2:IFTYpe?

[:SOURCE<hw>]:BB:EUTRa:TCW:IS:IFTYpe <InterfererType>

Selects the type of the interfering signal:

- For **Blocking** tests, the interfering signal can be an in-band EUTRA/LTE signal (EUTra) or out-of-band CW signal (CW).
- For **Receiver Intermodulation** tests, the first interfering signal can be an EUTRA/LTE signal (EUTra) or narrowband EUTRA signal (NEUTra). The second interfering signal is always a CW signal (CW).

Parameters:

<InterfererType> NEUTra | EUTra | CW | UTRA
 *RST: EUTra

Manual operation: See ["Interferer Type"](#) on page 519

[:SOURCE<hw>]:BB:EUTRa:TCW:IS:NRBLoCk?

Queries the number of RBs used by the LTE interfering signal.

Return values:

<NumResBlock> integer
 Range: 3 to 25
 *RST: 3

Usage: Query only

Manual operation: See ["Number of Resource Blocks"](#) on page 521

[:SOURCE<hw>]:BB:EUTRa:TCW:IS:NTAOffseT <SigAdvNTAoffset>

Sets the parameter $N_{TAoffset}$.

Parameters:

<SigAdvNTAoffset> NTA624 | NTA0
 *RST: NTA624

Manual operation: See ["Signal Advance N_TA_offset"](#) on page 520

[:SOURCE<hw>]:BB:EUTRa:TCW:IS:OCEDge <OffsChannelEdge>

Defines the offset of the interfering signal center frequency relative to edge of the wanted channel bandwidth.

Parameters:

<OffsChannelEdge> OCE12_5 | OCE7_5 | OCE2_5
 *RST: OCE2_5

Manual operation: See ["Offset to Channel Edge"](#) on page 513

[:SOURce<hw>]:BB:EUTRa:TCW:IS:OVRB?

Queries the offset VRB.

Return values:

<OffsetVRB> integer
 Range: 0 to 75
 *RST: 0

Usage: Query only

Manual operation: See ["Offset VRB"](#) on page 521

[:SOURce<hw>]:BB:EUTRa:TCW:IS2:PLEVel?**[:SOURce<hw>]:BB:EUTRa:TCW:IS3:PLEVel?****[:SOURce<hw>]:BB:EUTRa:TCW:IS:PLEVel?**

Queries the power level of the interfering signal.

Return values:

<PowerLevel> string

Usage: Query only

Manual operation: See ["Power Level/Power Level P-CPICH"](#) on page 514
 See ["Power Level"](#) on page 521

[:SOURce<hw>]:BB:EUTRa:TCW:IS2:RFFrequency <RfFrequency>**[:SOURce<hw>]:BB:EUTRa:TCW:IS:RFFrequency <RfFrequency>**

Queries the center frequency of the interfering signal.

Parameters:

<RfFrequency> integer
 Range: 100E3 to 6E9
 *RST: 1.95E9

Manual operation: See ["RF Frequency"](#) on page 513
 See ["RF Frequency"](#) on page 519

[:SOURce<hw>]:BB:EUTRa:TCW:IS:TDDConfig <TddConfig>

For TDD mode, selects the UL/DL Configuration number.

Parameters:

<TddConfig> integer
 Range: 0 to 6
 *RST: 0

Manual operation: See ["TDD UL/DL Configuration"](#) on page 520

[[:SOURce<hw>]:BB:EUTRa:TCW:IS:TModel?

Queries the test model. The interfering signal is generated according to E-TM1.1 test model.

Return values:

<TestModel> TM1_1

Usage: Query only

Manual operation: See ["Test Model"](#) on page 514

[[:SOURce<hw>]:BB:EUTRa:TCW:IS:UEID <UE_ID_nRNTI>

Sets the UE ID/n_RNTI for the interfering signal.

Parameters:

<UE_ID_nRNTI> integer
 Range: 0 to 65535
 *RST: 1

Manual operation: See ["UE ID/n_RNTI"](#) on page 521

[[:SOURce<hw>]:BB:EUTRa:TCW:TC <TestCase>

Selects the test case.

Parameters:

<TestCase> TS36141_TC839 | TS36141_TC834 | TS36141_TC835 |
 TS36141_TC836 | TS36141_TC67 | TS36141_TC72 |
 TS36141_TC73 | TS36141_TC74 | TS36141_TC75A |
 TS36141_TC75B | TS36141_TC76 | TS36141_TC78 |
 TS36141_TC821 | TS36141_TC822 | TS36141_TC823 |
 TS36141_TC824 | TS36141_TC831 | TS36141_TC832 |
 TS36141_TC833 | TS36141_TC841 | TS36141_TC838 |
 TS36141_TC837 | TS36141_TC826 | TS36141_TC826A |
 TS36141_TC827 | TS36141_TC829 | TS36141_TC8310 |
 TS36141_TC8311 | TS36141_TC8312 | TS36141_TC8313 |
 TS36141_TC851 | TS36141_TC852 | TS36141_TC853
 *RST: TS36141_TC72

Manual operation: See ["Test Case"](#) on page 503

[:SOURce<hw>]:BB:EUTRa:TCW:WS:CHBW <ChanBandwidth>

Selects the channel bandwidth in MHz: 20, 10, 5, 3, 1.4, 15, or 0.2 MHz.

Parameters:

<ChanBandwidth> BW20_00 | BW10_00 | BW5_00 | BW3_00 | BW1_40 |
 BW15_00 | BW00_20
 *RST: BW1_40

Manual operation: See "[Channel Bandwidth](#)" on page 506

[:SOURce<hw>]:BB:EUTRa:TCW:WS:CLID <CellId>

Sets the Cell ID.

Parameters:

<CellId> integer
 Range: 0 to 503
 *RST: 150

Manual operation: See "[Cell ID](#)" on page 507

[:SOURce<hw>]:BB:EUTRa:TCW:WS:CYCPrefix <CyclicPrefix>

Selects normal or extended cyclic prefix.

Parameters:

<CyclicPrefix> EXTended | NORMal
 *RST: NORMal

Manual operation: See "[Cyclic Prefix](#)" on page 507

[:SOURce<hw>]:BB:EUTRa:TCW:WS:DUPLex <Duplex>

Selects whether TDD or FDD duplexing mode is used.

Parameters:

<Duplex> TDD | FDD
 *RST: FDD

Manual operation: See "[Duplexing](#)" on page 506

[:SOURce<hw>]:BB:EUTRa:TCW:WS:FRC <FRC>

Queries the fixed reference channel used.

Parameters:

<FRC> A11 | A12 | A13 | A14 | A15 | A21 | A22 | A23 | A31 | A32 | A33 |
 A34 | A35 | A36 | A37 | A41 | A42 | A43 | A44 | A45 | A46 | A47 |
 A48 | A51 | A52 | A53 | A54 | A55 | A56 | A57 | A71 | A72 | A73 |
 A74 | A75 | A76 | A81 | A82 | A83 | A84 | A85 | A86 | UE11 |
 UE12 | UE21 | UE22 | UE3
 *RST: A11

Example:

SOURce1:BB:EUTRa:TCW:WS:FRC?

Manual operation: See ["FRC"](#) on page 507

[:SOURce<hw>]:BB:EUTRa:TCW:WS:NTAOffset <SigAdvNTAoffset>

Sets the parameter $N_{TAoffset}$.

Parameters:

<SigAdvNTAoffset> NTA624 | NTA0
 *RST: NTA624

Manual operation: See ["Signal Advance N_TA_offset"](#) on page 506

[:SOURce<hw>]:BB:EUTRa:TCW:WS:OUPLevel <OutPowerLevel>

The settings of the selected test case become active only after selecting "Apply Settings".

Parameters:

<OutPowerLevel> float
 Range: -115 to 0
 Increment: 0.01
 *RST: -30

Manual operation: See ["Output Power Level"](#) on page 516

[:SOURce<hw>]:BB:EUTRa:TCW:MUE:OVRB <OffsetVRB>

[:SOURce<hw>]:BB:EUTRa:TCW:SUE:OVRB <OffsetVRB>

[:SOURce<hw>]:BB:EUTRa:TCW:WS:OVRB <OffsetVRB>

Sets the number of RB the allocated RB(s) are shifted with.

Parameters:

<OffsetVRB> integer
 Range: 0 to 75
 *RST: 0

Manual operation: See ["Offset VRB"](#) on page 507

[:SOURce<hw>]:BB:EUTRa:TCW:WS:PLEVel?

Queries the Power Level.

Return values:

<PowerLevel> string

Usage: Query only

Manual operation: See "[Power Level](#)" on page 507

[:SOURce<hw>]:BB:EUTRa:TCW:WS:RFFrequency <RfFrequency>

Sets the RF frequency of the wanted signal.

Parameters:

<RfFrequency> integer

Range: 100E3 to 6E9

*RST: 1.95E9

Manual operation: See "[RF Frequency](#)" on page 506

[:SOURce<hw>]:BB:EUTRa:TCW:WS:TDDConfig <TddConfig>

For TDD mode, selects the UL/DL Configuration number.

Parameters:

<TddConfig> integer

Range: 0 to 6

*RST: 0

Manual operation: See "[TDD UL/DL Configuration](#)" on page 506

[:SOURce<hw>]:BB:EUTRa:TCW:MUE:UEID <UE_ID_nRNTI>

[:SOURce<hw>]:BB:EUTRa:TCW:SUE:UEID <UE_ID_nRNTI>

[:SOURce<hw>]:BB:EUTRa:TCW:WS:UEID <UE_ID_nRNTI>

Sets the UE ID/n_RNTI.

Parameters:

<UE_ID_nRNTI> integer

Range: 0 to 65535

*RST: 1

Manual operation: See "[UE ID/n_RNTI](#)" on page 507

Annex

A Conflict handling

In [TS 36.211](#), physical signals and physical channels are defined for the EUTRA/LTE system. Therefore the available resources in the time-frequency domain are shared by the different signals and different kinds of allocations (comparable to the different channel types in the 3GPP FDD mode).

A.1 Downlink

R&S SMM100A supports the following types of downlink signals and channels:

- Reference signals
- Primary synchronization signal (PSS)
- Secondary synchronization signal (SSS)
- Physical broadcast channel (PBCH)
- Physical Downlink Control Channel (PDCCH), including PCFICH and PHICH
- Physical Downlink Shared Channel (PDSCH)

Due to the concept of the R&S SMM100A, different situations can appear that need clarification. If several signals and/or channels (of the same or different type) partly share resources, a decision has to be made what bits are mapped to the affected subcarriers. The general rule here is that the signal or channel with higher priority is transmitted completely while the affected subcarriers are stamped out of the lower priority signal or channel. Note that this reduces the number of available physical bits of a signal/channel.



The actual size of a certain allocation is displayed in the column physical bits of the resource allocation table.

The following picture shows the priorities of the different signal and channel types.

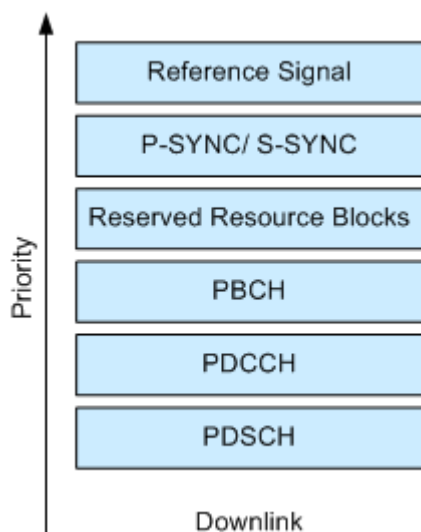

Figure A-1: Priority of different allocations, channels and signals in the downlink

- Overlapping of signals and/or channels with different priorities
In case signals or channels of different priorities overlap, no conflict is indicated in the resource allocation table, as the signal with the higher priority is transmitted completely.
- Overlapping of allocations with the same priority
If different allocations of the same priority are overlapping, the one with the lower allocation index (i.e. which comes first) in the resource allocation table is treated with higher priority. In this case, the reduced allocation is marked in the conflict column of the resource allocation table.



There is no way to configure a signal with overlapping reference signal and P-SYNC/S-SYNC.



If PRS and MBSFN are configured to be in the same subframe, MBSFN is skipped and PRS is transmitted solely.

If a PDSCH is configured to overlap partially with the PRS bandwidth in a PRS subframe, the PRS in these resource blocks is skipped then (see [Example"Overlapping PDSCH, PRS and MBSFN"](#) on page 105).

A.2 Uplink

In the uplink implementation of the R&S SMM100A, you can configure different user equipment (UEs) to use the same physical resources. The signals of the different UEs are added, nevertheless a conflict is indicated in the resource allocation table.

Although a conflict is also displayed if the PUSCH and PUCCH allocations of one UE are overlapping, the signals of both allocations are added. However, a conflict can

occur between the sounding reference signal of a certain UE and the PUSCH of another UE.

A.3 DCI conflict handling

In the R&S SMM100A, you can configure multiple scheduling messages with their corresponding PDCCHs per subframe. Using the DCI table in the [Chapter 4.3, "DL frame configuration settings"](#), on page 127 dialog, you can set appropriate CCE index and define the position of the DCI/PDCCH inside the multiplexed bitstream.

Because the number of CCEs for each PDCCH vary, the 3GPP specification [TS 36.211](#), chapter 6.8.1 defines some restriction on the aggregation of CCEs. An aggregation of eight CCEs for instance can only start on CCE numbers evenly dividable by eight. The same principle applies to the other aggregation levels. In this implementation, if the restriction is not fulfilled or two CCEs are overlapping, a conflict is displayed for the DCI/PDCCH with the greater number. This DCI/PDCCH is not considered by the multiplexing, i.e. it is not transmitted.

The R&S SMM100A provides the operations "Append", "Insert", "Delete", "Up", "Down" and "Resolve Conf." for flexibly configuration of valid DCIs and for resolving of conflicts.

Example:

This example is based on a DCI table of a control channel with a total "Number of CCEs = 26".

The "DCI Table" indicates a conflict in the second DCI/PDCCH. The reason for this conflict is that the CCEs allocated for the second DCI/PDCCH are overlapping with the CCEs used by the first one. The second DCI/PDCCH is ignored by the multiplexing.

	User	UE_ID n_RNTI	Cell Index	CIF	(E)PDCCH	DCI Format	Search Space	Content	(E)PDCCH Format	Number (E)CCEs	(E)CCE Index	No.Dummy (E)CCEs	Conflict
0	User1	0	0	-	PDCCH	0	Common	Config...	2	4	0	4	
1	User1	0	0	-	PDCCH	1A	UE-Spec	Config...	0	1	1	-	!
2	User2	250	0	-	PDCCH	0	UE-Spec	Config...	1	2	16	8	
3	RA_RNTI	1	0	-	PDCCH	1C	Common	Config...	2	4	8	4	

One of the ways to overcome this problem and to resolve the DCI conflict is to use the [Resolve Conflicts](#) function of the software. The built-in algorithm reassigns automatically the CCE values depending on the configured "Search Space"; previously configured CCE values are not maintained. The calculated signal is suitable for receiver tests that demand conflict free CCEs but have no requirements on explicit CCE values. If the conflict cannot be resolved automatically, the values remain unchanged.

If however there is a requirement for CCE indexes with explicit values, you can perform the corrections manually. In this particular example, you can set the CCE index of the third DCI/PDCCH to 4.

	User	UE_ID n_RNTI	Cell Index	CIF	(E)PDCCH	DCI Format	Search Space	Content	(E)PDCCH Format	Number (E)CCEs	(E)CCE Index	No.Dummy (E)CCEs	Conflict
0	User1	0	0	-	PDCCH	0	Common	Config...	2	4	4	0	
1	User1	0	0	-	PDCCH	1A	UE-Spec	Config...	0	1	1	2	
2	User2	250	0	-	PDCCH	0	UE-Spec	Config...	1	2	16	8	
3	RA_RNTI	1	0	-	PDCCH	1C	Common	Config...	2	4	8	4	

The CCEs used by the two subsequent DCIs/PDCCHs are not overlapping and the two DCIs/PDCCHs are configured to be transmitted consecutive, i.e. there is no gap between them ("No. Dummy CCEs" = 0).

The [Figure A-2](#) shows the resulting PDCCH after multiplexing.

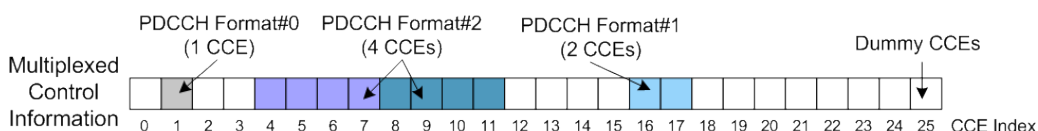

Figure A-2: PDCCH multiplexing (example)



If "Activate Carrier Aggregation > On", the parameter **DCI Table** determines the component carrier the corresponding User is mapped to. For this reason, there is no DCI conflict, if in the example above the second DCI belongs to a User enabled on an SCell.

	User	UE_ID n_RNTI	Cell Index	CIF	(E)PDCCH	DCI Format	Search Space	Content	(E)PDCCH Format	Number (E)CCEs	(E)CCE Index	No.Dummy (E)CCEs	Conflict
0	User1	0	0	-	PDCCH	0	Common	Config...	2	4	0	4	
1	User1	0	0	-	PDCCH	1A	UE-Spec	Config...	0	1	1	24	
2	User2	250	0	-	PDCCH	0	UE-Spec	Config...	1	2	16	8	
3	RA_RNTI	1	0	-	PDCCH	1C	Common	Config...	2	4	8	4	

B Subframes handling

The following sections explain the subframes handling concept and implementation in the R&S SMM100A.

B.1 Copy/paste subframe

The required EUTRA/LTE test signal consists of several subframes, possibly with the same or similar settings.

In these cases, you can:

- Copy and paste settings from one subframe to another.
- Configure a subset of subframes manually and use them periodically
See [Chapter B.2, "Number of configurable subframes"](#), on page 948

Consider, however, that with both methods only subset of settings are inherited.

Both methods maintain the following settings:

- Cyclic prefix length
- Structure of PDCCH and PDSCH allocations
- Structure of PUSCH and PUCCH allocations

The following settings are not considered:

- P-SYNC/S-SYNC
The P-SYNC/S-SYNC are global setting ("General DL Settings" dialog) and therefore cannot be overwritten by the configuration of one particular frame
- PBCH
The PBCH is transmitted in subframe#0 only
- PRACH and sounding reference signals
The SRS and the PRACH are settings dedicated to the individual user equipment ([User equipment configuration](#) dialog)

Copying allocations from a subframe without P-SYNC/S-SYNC/PBCH to one with P-SYNC/S-SYNC/PBCH and vice versa can lead to conflict situations. In this case, the internal algorithm applies the rules discussed in [Chapter A, "Conflict handling"](#), on page 943.

However, it can happen that allocations which are identical in terms of scheduled resource blocks have a different number of physical bits available in the different subframes. This situation occurs due to the out stamping of overlapping subcarriers.

B.2 Number of configurable subframes

As described in [Chapter B.1, "Copy/paste subframe"](#), on page 948, you can simplify the configuration of the EUTRA/LTE test signal if you define a small number of subframes manually ("Number of Configurable Subframes") and use them periodically.

Internally, the R&S SMM100A applies the [Copy/paste subframe](#) functionality and the same subset of settings are inherited.

B.3 Four configurable frames in uplink and downlink direction

The R&S SMM100A supports the configuration of up to four frames in uplink and downlink direction. However, there is a limitation for the maximum number of the real configurable subframes in these four frames depending on the transmission direction and several other parameters.

B.3.1 Uplink direction

The maximum number of configurable subframes changes as function of the parameters in the following way:

- For **disabled** Realtime Feedback
 - In FDD duplexing mode, the maximum number of configurable subframes is 40 subframes, where the maximum number of 40 subframes is available for sequence lengths of at least four frames
 - In a TDD frame, only the uplink subframes are enabled for configuration. The maximum number of the configurable subframes is determined by the selected "UL/DL Configuration" and the possible values are listed in the corresponding column in the cross-reference table below.

The current subframe to be configured is selected by means of the parameter [Subframe](#).



The configurable range ("Number of configurable uplink subframes") can be selected independently for the individual user equipment (UE). Furthermore, for LTE-A UEs, the range can be selected independently for the PUCCH and the PUSCH channel.

Subframes behind the configurable range of the corresponding UE or channel are indicated as read-only.

Four configurable frames in uplink and downlink direction

Table B-1: Value range for the parameter Number of Configurable UL Subframes

"Duplexing mode"	"UL/DL Configuration"	UL subframes in the first four frames (see Figure 2-5)	Number of UL subframes per frame	Number of HARQ processes	Value range for the parameter "Number of Configurable UL Subframes"	
					Disabled realtime feedback	Enabled realtime feedback
TDD	0	2, 3, 4, 7, 8, 9, 12, 13, 14, 17, 18, 19, 22, 23, 24, 27, 28, 29, 32, 33, 34, 37, 38, 39	6	7	1 to 24	1, 7
	1	2, 3, 7, 8, 12, 13, 17, 18, 22, 23, 27, 28, 32, 33, 37, 38	4	4	1 to 16	1, 2, 4
	2	2, 7, 12, 17, 22, 27, 32, 37	2	2	1 to 8	1, 2
	3	2, 3, 4, 12, 13, 14, 22, 23, 24, 32, 33, 34	3	3	1 to 12	1, 3
	4	2, 3, 12, 13, 22, 23, 32, 33	2	2	1 to 8	1, 2
	5	2, 12, 22, 32	1	1	1 to 4	1
	6	2, 3, 4, 7, 8, 12, 13, 14, 17, 18, 22, 23, 24, 27, 28, 32, 33, 34, 37, 38	5	6	1 to 20	1, 2, 3, 6
FDD	-	0 .. 39	10	8	1 to 40	1, 2, 4, 8

Four configurable frames in uplink and downlink direction

Example:

- For selected FDD duplexing mode and "**Number of Configurable Uplink Subframes = 13**", "Subframes = 0 to 12" are configurable. Subframes from 13 on are read-only.
- For selected TDD duplexing mode and "UL/DL Configuration = 6", the "Number of Configurable Uplink Subframes = 1 to 20". (See [Table B-1](#)).
If for instance the "Number of Configurable Uplink Subframes = 10", the following ten subframes are configurable: 2, 3, 4, 7, 8, 12, 13, 14, 17, 18.
These subframes are the first ten uplink subframes. All other subframes (downlink subframes, special subframes and subframes from 19 on) are read-only.

B.3.2 Downlink direction

In downlink direction, the maximum number of the real configurable subframes depends on the selected [General settings](#) mode (TDD or FDD), [TDD frame structure settings](#). In downlink direction, the special subframes are also configurable (in addition to the downlink subframes).

The subframe to be configured is selected by means of the parameter "Subframe Selection". The maximum value for this parameter is then determined by the number of the last configurable subframe (see also [Table B-2](#)).

Table B-2: Value range for the parameter Number of Configurable DL Subframes

Duplexing mode	UL/DL Configuration	DL and special subframes in the first four frames (see Figure 2-5)	Number of DL and special subframes per frame	Value range for the parameter "Number of Configurable DL Subframes"
TDD	0	0, 1, 5, 6, 10, 11, 15, 16, 20, 21, 25, 26, 30, 31, 35, 36	4	1 to 16
	1	0, 1, 4, 5, 6, 9 10, 11, 14, 15, 16, 19 20, 21, 24, 25, 26, 29, 30, 31, 34, 35, 36, 39	6	1 to 24
	2	0, 1, 3, 4, 5, 6, 8, 9 10, 11, 13, 14, 15, 16, 18, 19 20, 21, 23, 24, 25, 26, 28, 29, 30, 31, 33, 34, 35, 36, 38, 39	8	1 to 32
	3	0, 1, 5, 6, 7, 8, 9 10, 11, 15, 16, 17, 18, 19 20, 21, 25, 26, 27, 28, 29, 30, 31, 35, 36, 37, 38, 39	7	1 to 28

Four configurable frames in uplink and downlink direction

Duplexing mode	UL/DL Configuration	DL and special subframes in the first four frames (see Figure 2-5)	Number of DL and special subframes per frame	Value range for the parameter "Number of Configurable DL Subframes"
	4	0, 1, 4, 5, 6, 7, 8, 9 10, 11, 14, 15, 16, 17, 18, 19 20, 21, 24, 25, 26, 27, 28, 29, 30, 31, 34, 35, 36, 37, 38, 39	8	1 to 32
	5	0, 1, 3, 4, 5, 6, 7, 8, 9 10, 11, 13, 14, 15, 16, 17, 18, 19 20, 21, 23, 24, 25, 26, 27, 28, 29, 30, 31, 33, 34, 35, 36, 37, 38, 39	9	1 to 36
	6	0, 1, 5, 6, 9 10, 11, 15, 16, 19, 20, 21, 25, 26, 29, 30, 31, 35, 36, 39	5	1 to 20
FDD	-	0 .. 39	10	1 to 40

Glossary: 3GPP specifications, references

Symbols

[17]: Rohde&Schwarz

C. Gessner, "Long Term Evolution. A concise introduction to LTE and its measurement requirements", ISBN 978-3-939837-11-4, First edition 2011

1MA166: Rohde&Schwarz

Application Note [1MA166](#) "Testing LTE-Advanced"

1MA169: Rohde&Schwarz

White Paper [1MA169](#) "LTE-Advanced Technology Introduction"

1MA232: Rohde&Schwarz

White Paper [1MA232](#) "LTE-Advanced (3GPP Rel. 11) Technology Introduction"

1MA252: Rohde&Schwarz

White Paper [1MA252](#) "LTE-Advanced (3GPP Rel. 12) Technology Introduction"

1MA266: Rohde&Schwarz

White Paper [1MA266](#) "Narrowband Internet of Things"

1MA296: Rohde&Schwarz

White Paper [1MA296](#) "Narrowband Internet of Things Measurements"

T

TR 25.892: "Feasibility study for Orthogonal Frequency Division Multiplexing (OFDM) for UTRAN enhancement"

TR 25.913: "Requirements for Evolved UTRA (E-UTRA) and Evolved UTRAN (E-UTRAN)"

TR 36.912 V 9.1.0: "Technical Specification Group Radio Access Network; Feasibility study for further advancements for E-UTRA (LTE-Advanced), Release 9", December 2009

TS 25.141: "Base Station (BS) conformance testing (FDD)"

TS 36.101: "Evolved Universal Terrestrial Radio Access (E-UTRA); User Equipment (UE) radio transmission and reception"

TS 36.104: "Evolved Universal Terrestrial Radio Access (E-UTRA); Base Station (BS) radio transmission and reception"

TS 36.106: "Evolved Universal Terrestrial Radio Access (E-UTRA); FDD repeater radio transmission and reception"

TS 36.113: "Evolved Universal Terrestrial Radio Access (E-UTRA); Base Station (BS) and repeater ElectroMagnetic Compatibility (EMC)"

TS 36.124: "Evolved Universal Terrestrial Radio Access (E-UTRA); ElectroMagnetic Compatibility (EMC) requirements for mobile terminals and ancillary equipment"

TS 36.133: "Evolved Universal Terrestrial Radio Access (E-UTRA); Requirements for support of radio resource management"

TS 36.141: "Evolved Universal Terrestrial Radio Access (E-UTRA); Base Station (BS) conformance testing"

TS 36.143: "Evolved Universal Terrestrial Radio Access (E-UTRA); FDD repeater conformance testing"

TS 36.211: "Evolved Universal Terrestrial Radio Access (E-UTRA); Physical Channels and Modulation"

TS 36.212: "Evolved Universal Terrestrial Radio Access (E-UTRA); Multiplexing and channel coding"

TS 36.213: "Evolved Universal Terrestrial Radio Access (E-UTRA); Physical layer procedures"

TS 36.214: "Evolved Universal Terrestrial Radio Access (E-UTRA); Physical layer; Measurements"

TS 36.306: "Evolved Universal Terrestrial Radio Access (E-UTRA); User Equipment (UE) radio access capabilities"

TS 36.331: "Evolved Universal Terrestrial Radio Access (E-UTRA); Radio Resource Control (RRC); Protocol specification"

TS 36.355: "Evolved Universal Terrestrial Radio Access (E-UTRA); LTE Positioning Protocol (LPP)"

TS 36.521: "Evolved Universal Terrestrial Radio Access (E-UTRA); User Equipment (UE) conformance specification; Radio transmission and reception; Part 1, 2, 3"

TS 36.523: "Evolved Universal Terrestrial Radio Access (E-UTRA); User Equipment (UE) conformance specification; Part 1, 2, 3"

List of commands

[:SOURce]:BB:EUTRa:VERSion?	560
[:SOURce<hw>]:BB:EUTRa:CLIPping:LEVel	565
[:SOURce<hw>]:BB:EUTRa:CLIPping:MODE	565
[:SOURce<hw>]:BB:EUTRa:CLIPping:STATe	565
[:SOURce<hw>]:BB:EUTRa:CLOCK:MODE	569
[:SOURce<hw>]:BB:EUTRa:CLOCK:SOURce	568
[:SOURce<hw>]:BB:EUTRa:DL:BUR	604
[:SOURce<hw>]:BB:EUTRa:DL:BW	584
[:SOURce<hw>]:BB:EUTRa:DL:CA:CELL<ch0>:BB	625
[:SOURce<hw>]:BB:EUTRa:DL:CA:CELL<ch0>:BW	625
[:SOURce<hw>]:BB:EUTRa:DL:CA:CELL<ch0>:CIF	626
[:SOURce<hw>]:BB:EUTRa:DL:CA:CELL<ch0>:DFReq	626
[:SOURce<hw>]:BB:EUTRa:DL:CA:CELL<ch0>:DUPLexing	626
[:SOURce<hw>]:BB:EUTRa:DL:CA:CELL<ch0>:ID	626
[:SOURce<hw>]:BB:EUTRa:DL:CA:CELL<ch0>:INDEX	627
[:SOURce<hw>]:BB:EUTRa:DL:CA:CELL<ch0>:PHICH:DUration	629
[:SOURce<hw>]:BB:EUTRa:DL:CA:CELL<ch0>:PHICH:NGParameter	629
[:SOURce<hw>]:BB:EUTRa:DL:CA:CELL<ch0>:POFFset	628
[:SOURce<hw>]:BB:EUTRa:DL:CA:CELL<ch0>:PSTart	628
[:SOURce<hw>]:BB:EUTRa:DL:CA:CELL<ch0>:SCINdex	628
[:SOURce<hw>]:BB:EUTRa:DL:CA:CELL<ch0>:SPSConf	627
[:SOURce<hw>]:BB:EUTRa:DL:CA:CELL<ch0>:STATe	629
[:SOURce<hw>]:BB:EUTRa:DL:CA:CELL<ch0>:TDElay	628
[:SOURce<hw>]:BB:EUTRa:DL:CA:CELL<ch0>:UDConf	627
[:SOURce<hw>]:BB:EUTRa:DL:CA:STATe	625
[:SOURce<hw>]:BB:EUTRa:DL:CARRier<ch>:NIOT:CELL	834
[:SOURce<hw>]:BB:EUTRa:DL:CARRier<ch>:NIOT:CIDGroup	835
[:SOURce<hw>]:BB:EUTRa:DL:CARRier<ch>:NIOT:CRSSeq	834
[:SOURce<hw>]:BB:EUTRa:DL:CARRier<ch>:NIOT:DFReq	834
[:SOURce<hw>]:BB:EUTRa:DL:CARRier<ch>:NIOT:GBRBidx	835
[:SOURce<hw>]:BB:EUTRa:DL:CARRier<ch>:NIOT:MODE	833
[:SOURce<hw>]:BB:EUTRa:DL:CARRier<ch>:NIOT:NVSF	835
[:SOURce<hw>]:BB:EUTRa:DL:CARRier<ch>:NIOT:RBIDx	834
[:SOURce<hw>]:BB:EUTRa:DL:CARRier<ch>:NIOT:SF<st0>:VALSf	836
[:SOURce<hw>]:BB:EUTRa:DL:CARRier<ch>:NIOT:SFALI	836
[:SOURce<hw>]:BB:EUTRa:DL:CARRier<ch>:NIOT:SFNN	836
[:SOURce<hw>]:BB:EUTRa:DL:CARRier<ch>:NIOT:STATe	838
[:SOURce<hw>]:BB:EUTRa:DL:CONF:MODE	580
[:SOURce<hw>]:BB:EUTRa:DL:CONSubframes	605
[:SOURce<hw>]:BB:EUTRa:DL:CPC	588
[:SOURce<hw>]:BB:EUTRa:DL:CSETtings:RARNti	588
[:SOURce<hw>]:BB:EUTRa:DL:CSIS[:CELL<ch0>]:CDMType	636
[:SOURce<hw>]:BB:EUTRa:DL:CSIS[:CELL<ch0>]:CONFig[<st>]	631
[:SOURce<hw>]:BB:EUTRa:DL:CSIS[:CELL<ch0>]:DWPTs	634
[:SOURce<hw>]:BB:EUTRa:DL:CSIS[:CELL<ch0>]:FRDensity[<st>]	636
[:SOURce<hw>]:BB:EUTRa:DL:CSIS[:CELL<ch0>]:NAP	631
[:SOURce<hw>]:BB:EUTRa:DL:CSIS[:CELL<ch0>]:NCFG	635

[SOURce<hw>]:BB:EUTRa:DL:CSIS[:CELL<ch0>]:POW.....	631
[SOURce<hw>]:BB:EUTRa:DL:CSIS[:CELL<ch0>]:SCID.....	635
[SOURce<hw>]:BB:EUTRa:DL:CSIS[:CELL<ch0>]:SFDelta?.....	632
[SOURce<hw>]:BB:EUTRa:DL:CSIS[:CELL<ch0>]:SFI.....	632
[SOURce<hw>]:BB:EUTRa:DL:CSIS[:CELL<ch0>]:SFT?.....	632
[SOURce<hw>]:BB:EUTRa:DL:CSIS[:CELL<ch0>]:STATe.....	632
[SOURce<hw>]:BB:EUTRa:DL:CSIS[:CELL<ch0>]:TRANscomb[<st>].....	636
[SOURce<hw>]:BB:EUTRa:DL:CSIS[:CELL<ch0>][:ZPRS<st0>]:ZP.....	633
[SOURce<hw>]:BB:EUTRa:DL:CSIS[:CELL<ch0>][:ZPRS<st0>]:ZPDelta?.....	633
[SOURce<hw>]:BB:EUTRa:DL:CSIS[:CELL<ch0>][:ZPRS<st0>]:ZPI.....	634
[SOURce<hw>]:BB:EUTRa:DL:CSIS[:CELL<ch0>][:ZPRS<st0>]:ZPT?.....	634
[SOURce<hw>]:BB:EUTRa:DL:DRS:CELL<ch0>:CDSTate.....	640
[SOURce<hw>]:BB:EUTRa:DL:DRS:CELL<ch0>:CSIRs<st>:NZConfig.....	643
[SOURce<hw>]:BB:EUTRa:DL:DRS:CELL<ch0>:CSIRs<st>:NZQoffset.....	644
[SOURce<hw>]:BB:EUTRa:DL:DRS:CELL<ch0>:CSIRs<st>:NZSCid.....	642
[SOURce<hw>]:BB:EUTRa:DL:DRS:CELL<ch0>:CSIRs<st>:NZSFOffset.....	643
[SOURce<hw>]:BB:EUTRa:DL:DRS:CELL<ch0>:CSIRs<st>:ZP.....	641
[SOURce<hw>]:BB:EUTRa:DL:DRS:CELL<ch0>:CSIRs<st>:ZPDelta?.....	642
[SOURce<hw>]:BB:EUTRa:DL:DRS:CELL<ch0>:CSIRs<st>:ZPI.....	641
[SOURce<hw>]:BB:EUTRa:DL:DRS:CELL<ch0>:CSIRs<st>:ZPT?.....	642
[SOURce<hw>]:BB:EUTRa:DL:DRS:CELL<ch0>:DURation.....	640
[SOURce<hw>]:BB:EUTRa:DL:DRS:CELL<ch0>:NZPNum.....	641
[SOURce<hw>]:BB:EUTRa:DL:DRS:CELL<ch0>:OFFSet.....	639
[SOURce<hw>]:BB:EUTRa:DL:DRS:CELL<ch0>:PATtern.....	640
[SOURce<hw>]:BB:EUTRa:DL:DRS:CELL<ch0>:PERiodicity.....	639
[SOURce<hw>]:BB:EUTRa:DL:DRS:CELL<ch0>:STATe.....	639
[SOURce<hw>]:BB:EUTRa:DL:DRS:CELL<ch0>:ZPNum.....	640
[SOURce<hw>]:BB:EUTRa:DL:DUMD:DATA.....	743
[SOURce<hw>]:BB:EUTRa:DL:DUMD:DSElect.....	743
[SOURce<hw>]:BB:EUTRa:DL:DUMD:MODulation.....	742
[SOURce<hw>]:BB:EUTRa:DL:DUMD:OPSubframes.....	744
[SOURce<hw>]:BB:EUTRa:DL:DUMD:PATtern.....	744
[SOURce<hw>]:BB:EUTRa:DL:DUMD:POWer.....	743
[SOURce<hw>]:BB:EUTRa:DL:EMTC:ALLoc<ch0>:ABSFrames?.....	878
[SOURce<hw>]:BB:EUTRa:DL:EMTC:ALLoc<ch0>:CCODing:MIB.....	889
[SOURce<hw>]:BB:EUTRa:DL:EMTC:ALLoc<ch0>:CCODing:MSPare.....	890
[SOURce<hw>]:BB:EUTRa:DL:EMTC:ALLoc<ch0>:CCODing:RSIB?.....	890
[SOURce<hw>]:BB:EUTRa:DL:EMTC:ALLoc<ch0>:CCODing:SIB.....	889
[SOURce<hw>]:BB:EUTRa:DL:EMTC:ALLoc<ch0>:CCODing:SOFFset.....	890
[SOURce<hw>]:BB:EUTRa:DL:EMTC:ALLoc<ch0>:CCODing:SRPeriod.....	890
[SOURce<hw>]:BB:EUTRa:DL:EMTC:ALLoc<ch0>:CCODing:STATe.....	888
[SOURce<hw>]:BB:EUTRa:DL:EMTC:ALLoc<ch0>:CCODing:TBSI.....	889
[SOURce<hw>]:BB:EUTRa:DL:EMTC:ALLoc<ch0>:CCODing:TBSIze?.....	888
[SOURce<hw>]:BB:EUTRa:DL:EMTC:ALLoc<ch0>:CODWords?.....	883
[SOURce<hw>]:BB:EUTRa:DL:EMTC:ALLoc<ch0>:CONFLict?.....	882
[SOURce<hw>]:BB:EUTRa:DL:EMTC:ALLoc<ch0>:CONType?.....	877
[SOURce<hw>]:BB:EUTRa:DL:EMTC:ALLoc<ch0>:DATA.....	880
[SOURce<hw>]:BB:EUTRa:DL:EMTC:ALLoc<ch0>:DSElect.....	880
[SOURce<hw>]:BB:EUTRa:DL:EMTC:ALLoc<ch0>:MODulation?.....	878
[SOURce<hw>]:BB:EUTRa:DL:EMTC:ALLoc<ch0>:NORB?.....	879

[SOURce<hw>]:BB:EUTRa:DL:EMTC:ALLoc<ch0>:OVRB?	879
[SOURce<hw>]:BB:EUTRa:DL:EMTC:ALLoc<ch0>:PATtern	881
[SOURce<hw>]:BB:EUTRa:DL:EMTC:ALLoc<ch0>:PHYsbits?	880
[SOURce<hw>]:BB:EUTRa:DL:EMTC:ALLoc<ch0>:POWer	881
[SOURce<hw>]:BB:EUTRa:DL:EMTC:ALLoc<ch0>:PRECoding:AP?	885
[SOURce<hw>]:BB:EUTRa:DL:EMTC:ALLoc<ch0>:PRECoding:AP<dir0>:BB<st0>:IMAGinary?	887
[SOURce<hw>]:BB:EUTRa:DL:EMTC:ALLoc<ch0>:PRECoding:AP<dir0>:BB<st0>:REAL?	886
[SOURce<hw>]:BB:EUTRa:DL:EMTC:ALLoc<ch0>:PRECoding:APM?	886
[SOURce<hw>]:BB:EUTRa:DL:EMTC:ALLoc<ch0>:PRECoding:CBIndex	884
[SOURce<hw>]:BB:EUTRa:DL:EMTC:ALLoc<ch0>:PRECoding:CCD	884
[SOURce<hw>]:BB:EUTRa:DL:EMTC:ALLoc<ch0>:PRECoding:DAFormat	886
[SOURce<hw>]:BB:EUTRa:DL:EMTC:ALLoc<ch0>:PRECoding:NOLayers?	883
[SOURce<hw>]:BB:EUTRa:DL:EMTC:ALLoc<ch0>:PRECoding:SCHEME	883
[SOURce<hw>]:BB:EUTRa:DL:EMTC:ALLoc<ch0>:PRECoding:SCID?	886
[SOURce<hw>]:BB:EUTRa:DL:EMTC:ALLoc<ch0>:PRECoding:TRSCHEME?	884
[SOURce<hw>]:BB:EUTRa:DL:EMTC:ALLoc<ch0>:SCRambling:STATE	887
[SOURce<hw>]:BB:EUTRa:DL:EMTC:ALLoc<ch0>:SCRambling:UEID?	888
[SOURce<hw>]:BB:EUTRa:DL:EMTC:ALLoc<ch0>:STATE?	881
[SOURce<hw>]:BB:EUTRa:DL:EMTC:ALLoc<ch0>:STNB?	879
[SOURce<hw>]:BB:EUTRa:DL:EMTC:ALLoc<ch0>:STSFrame?	878
[SOURce<hw>]:BB:EUTRa:DL:EMTC:ALLoc<ch0>:STSYmbol?	879
[SOURce<hw>]:BB:EUTRa:DL:EMTC:BMP:PBCHrep	839
[SOURce<hw>]:BB:EUTRa:DL:EMTC:BMP:SElectall DESelectall	839
[SOURce<hw>]:BB:EUTRa:DL:EMTC:BMP:SIBBr	839
[SOURce<hw>]:BB:EUTRa:DL:EMTC:BMP:START	839
[SOURce<hw>]:BB:EUTRa:DL:EMTC:BMP:SUBFrames	838
[SOURce<hw>]:BB:EUTRa:DL:EMTC:BMP:VALSubframes<ch>	840
[SOURce<hw>]:BB:EUTRa:DL:EMTC:DCI:ALLoc<ch0>:APSI	875
[SOURce<hw>]:BB:EUTRa:DL:EMTC:DCI:ALLoc<ch0>:BITS?	868
[SOURce<hw>]:BB:EUTRa:DL:EMTC:DCI:ALLoc<ch0>:CCES?	868
[SOURce<hw>]:BB:EUTRa:DL:EMTC:DCI:ALLoc<ch0>:CONFLict?	869
[SOURce<hw>]:BB:EUTRa:DL:EMTC:DCI:ALLoc<ch0>:CSIRequest	874
[SOURce<hw>]:BB:EUTRa:DL:EMTC:DCI:ALLoc<ch0>:DAIndex	873
[SOURce<hw>]:BB:EUTRa:DL:EMTC:DCI:ALLoc<ch0>:DIInfo	877
[SOURce<hw>]:BB:EUTRa:DL:EMTC:DCI:ALLoc<ch0>:FMT	867
[SOURce<hw>]:BB:EUTRa:DL:EMTC:DCI:ALLoc<ch0>:HARQ	872
[SOURce<hw>]:BB:EUTRa:DL:EMTC:DCI:ALLoc<ch0>:HRESoffset	875
[SOURce<hw>]:BB:EUTRa:DL:EMTC:DCI:ALLoc<ch0>:IDCCe	868
[SOURce<hw>]:BB:EUTRa:DL:EMTC:DCI:ALLoc<ch0>:MCS	871
[SOURce<hw>]:BB:EUTRa:DL:EMTC:DCI:ALLoc<ch0>:MPDCchset	866
[SOURce<hw>]:BB:EUTRa:DL:EMTC:DCI:ALLoc<ch0>:NDCCes?	868
[SOURce<hw>]:BB:EUTRa:DL:EMTC:DCI:ALLoc<ch0>:NDINd	872
[SOURce<hw>]:BB:EUTRa:DL:EMTC:DCI:ALLoc<ch0>:NREP	872
[SOURce<hw>]:BB:EUTRa:DL:EMTC:DCI:ALLoc<ch0>:PAGNg	876
[SOURce<hw>]:BB:EUTRa:DL:EMTC:DCI:ALLoc<ch0>:PDCCh	867
[SOURce<hw>]:BB:EUTRa:DL:EMTC:DCI:ALLoc<ch0>:PDSHopping?	870
[SOURce<hw>]:BB:EUTRa:DL:EMTC:DCI:ALLoc<ch0>:PFRHopp	871
[SOURce<hw>]:BB:EUTRa:DL:EMTC:DCI:ALLoc<ch0>:PMIConfirm	875
[SOURce<hw>]:BB:EUTRa:DL:EMTC:DCI:ALLoc<ch0>:PRAMask	876
[SOURce<hw>]:BB:EUTRa:DL:EMTC:DCI:ALLoc<ch0>:PRAPreamble	876

[SOURce<hw>]:BB:EUTRa:DL:EMTC:DCI:ALLoc<ch0>:PRASStart.....	876
[SOURce<hw>]:BB:EUTRa:DL:EMTC:DCI:ALLoc<ch0>:RBA.....	871
[SOURce<hw>]:BB:EUTRa:DL:EMTC:DCI:ALLoc<ch0>:RBAF?.....	871
[SOURce<hw>]:BB:EUTRa:DL:EMTC:DCI:ALLoc<ch0>:REPMpdccch?.....	869
[SOURce<hw>]:BB:EUTRa:DL:EMTC:DCI:ALLoc<ch0>:REPPdsch?.....	870
[SOURce<hw>]:BB:EUTRa:DL:EMTC:DCI:ALLoc<ch0>:RVER.....	872
[SOURce<hw>]:BB:EUTRa:DL:EMTC:DCI:ALLoc<ch0>:SFRNumber.....	874
[SOURce<hw>]:BB:EUTRa:DL:EMTC:DCI:ALLoc<ch0>:SRSRequest.....	874
[SOURce<hw>]:BB:EUTRa:DL:EMTC:DCI:ALLoc<ch0>:SSP.....	867
[SOURce<hw>]:BB:EUTRa:DL:EMTC:DCI:ALLoc<ch0>:STRV?.....	870
[SOURce<hw>]:BB:EUTRa:DL:EMTC:DCI:ALLoc<ch0>:STSFrame.....	867
[SOURce<hw>]:BB:EUTRa:DL:EMTC:DCI:ALLoc<ch0>:TBS?.....	869
[SOURce<hw>]:BB:EUTRa:DL:EMTC:DCI:ALLoc<ch0>:TCMD.....	870
[SOURce<hw>]:BB:EUTRa:DL:EMTC:DCI:ALLoc<ch0>:TCPusch.....	873
[SOURce<hw>]:BB:EUTRa:DL:EMTC:DCI:ALLoc<ch0>:TPMPrec.....	875
[SOURce<hw>]:BB:EUTRa:DL:EMTC:DCI:ALLoc<ch0>:UEID?.....	866
[SOURce<hw>]:BB:EUTRa:DL:EMTC:DCI:ALLoc<ch0>:UEMode.....	874
[SOURce<hw>]:BB:EUTRa:DL:EMTC:DCI:ALLoc<ch0>:ULIndex.....	873
[SOURce<hw>]:BB:EUTRa:DL:EMTC:DCI:ALLoc<ch0>:USER.....	866
[SOURce<hw>]:BB:EUTRa:DL:EMTC:DCI:AWARound.....	865
[SOURce<hw>]:BB:EUTRa:DL:EMTC:DCI:NALLoc.....	865
[SOURce<hw>]:BB:EUTRa:DL:EMTC:NALLoc?.....	877
[SOURce<hw>]:BB:EUTRa:DL:EMTC:NB:HOFFset.....	840
[SOURce<hw>]:BB:EUTRa:DL:EMTC:NB:HOPping.....	840
[SOURce<hw>]:BB:EUTRa:DL:EMTC:NB:IVLA.....	841
[SOURce<hw>]:BB:EUTRa:DL:EMTC:NB:IVLB.....	841
[SOURce<hw>]:BB:EUTRa:DL:EMTC:NB:NNBands?.....	840
[SOURce<hw>]:BB:EUTRa:DL:EMTC:NB:PHOPping.....	841
[SOURce<hw>]:BB:EUTRa:DL:EMTC:NB:PSTNb.....	841
[SOURce<hw>]:BB:EUTRa:DL:EMTC:NB:RHOPping.....	841
[SOURce<hw>]:BB:EUTRa:DL:EMTC:NB:RSTNb.....	841
[SOURce<hw>]:BB:EUTRa:DL:EMTC:NNBands?.....	823
[SOURce<hw>]:BB:EUTRa:DL:EMTC:NWBands?.....	824
[SOURce<hw>]:BB:EUTRa:DL:EMTC:SSP:MPD1.....	842
[SOURce<hw>]:BB:EUTRa:DL:EMTC:SSP:MPD2.....	842
[SOURce<hw>]:BB:EUTRa:DL:EMTC:SSP:PDSA.....	842
[SOURce<hw>]:BB:EUTRa:DL:EMTC:SSP:PDSB.....	842
[SOURce<hw>]:BB:EUTRa:DL:EMTC:SSP:STSF.....	842
[SOURce<hw>]:BB:EUTRa:DL:EMTC:WBCFg.....	823
[SOURce<hw>]:BB:EUTRa:DL:FFT.....	585
[SOURce<hw>]:BB:EUTRa:DL:LAA:CEIndex.....	644
[SOURce<hw>]:BB:EUTRa:DL:LAA:CELL<ch0>:BURSt<st0>:C1Mode.....	646
[SOURce<hw>]:BB:EUTRa:DL:LAA:CELL<ch0>:BURSt<st0>:DURation.....	645
[SOURce<hw>]:BB:EUTRa:DL:LAA:CELL<ch0>:BURSt<st0>:ENSFrame?.....	646
[SOURce<hw>]:BB:EUTRa:DL:LAA:CELL<ch0>:BURSt<st0>:EPDCch.....	647
[SOURce<hw>]:BB:EUTRa:DL:LAA:CELL<ch0>:BURSt<st0>:LSFSymbols.....	646
[SOURce<hw>]:BB:EUTRa:DL:LAA:CELL<ch0>:BURSt<st0>:STSFrame.....	645
[SOURce<hw>]:BB:EUTRa:DL:LAA:CELL<ch0>:BURSt<st0>:STSLot.....	645
[SOURce<hw>]:BB:EUTRa:DL:LAA:CELL<ch0>:NUMBursts.....	644
[SOURce<hw>]:BB:EUTRa:DL:LGS?.....	586

[SOURce<hw>]:BB:EUTRa:DL:MBSFn:AI:ID.....	615
[SOURce<hw>]:BB:EUTRa:DL:MBSFn:AI:MCCH:AVAL?.....	615
[SOURce<hw>]:BB:EUTRa:DL:MBSFn:AI:MCCH:DATA.....	615
[SOURce<hw>]:BB:EUTRa:DL:MBSFn:AI:MCCH:DLIST.....	615
[SOURce<hw>]:BB:EUTRa:DL:MBSFn:AI:MCCH:MCS.....	616
[SOURce<hw>]:BB:EUTRa:DL:MBSFn:AI:MCCH:MODulation?.....	616
[SOURce<hw>]:BB:EUTRa:DL:MBSFn:AI:MCCH:MPER.....	616
[SOURce<hw>]:BB:EUTRa:DL:MBSFn:AI:MCCH:NOFFset.....	616
[SOURce<hw>]:BB:EUTRa:DL:MBSFn:AI:MCCH:NPATern.....	617
[SOURce<hw>]:BB:EUTRa:DL:MBSFn:AI:MCCH:NRC.....	617
[SOURce<hw>]:BB:EUTRa:DL:MBSFn:AI:MCCH:NSI.....	617
[SOURce<hw>]:BB:EUTRa:DL:MBSFn:AI:MCCH:OFFS.....	618
[SOURce<hw>]:BB:EUTRa:DL:MBSFn:AI:MCCH:PATern.....	618
[SOURce<hw>]:BB:EUTRa:DL:MBSFn:AI:MCCH:RPER.....	618
[SOURce<hw>]:BB:EUTRa:DL:MBSFn:AI:MCCH:STATe.....	618
[SOURce<hw>]:BB:EUTRa:DL:MBSFn:AI:MCCH:TBSize?.....	619
[SOURce<hw>]:BB:EUTRa:DL:MBSFn:AI:NIND.....	619
[SOURce<hw>]:BB:EUTRa:DL:MBSFn:AI:NMRL.....	619
[SOURce<hw>]:BB:EUTRa:DL:MBSFn:MODE.....	620
[SOURce<hw>]:BB:EUTRa:DL:MBSFn:MTCH:CSAP.....	620
[SOURce<hw>]:BB:EUTRa:DL:MBSFn:MTCH:NPMChs.....	620
[SOURce<hw>]:BB:EUTRa:DL:MBSFn:PMCH<ch0>:DATA.....	621
[SOURce<hw>]:BB:EUTRa:DL:MBSFn:PMCH<ch0>:DLIST.....	621
[SOURce<hw>]:BB:EUTRa:DL:MBSFn:PMCH<ch0>:MCS.....	622
[SOURce<hw>]:BB:EUTRa:DL:MBSFn:PMCH<ch0>:MCSTwo.....	621
[SOURce<hw>]:BB:EUTRa:DL:MBSFn:PMCH<ch0>:MOD?.....	622
[SOURce<hw>]:BB:EUTRa:DL:MBSFn:PMCH<ch0>:PATern.....	621
[SOURce<hw>]:BB:EUTRa:DL:MBSFn:PMCH<ch0>:SAENd.....	623
[SOURce<hw>]:BB:EUTRa:DL:MBSFn:PMCH<ch0>:SASart.....	623
[SOURce<hw>]:BB:EUTRa:DL:MBSFn:PMCH<ch0>:SPERiod.....	622
[SOURce<hw>]:BB:EUTRa:DL:MBSFn:PMCH<ch0>:STATe.....	620
[SOURce<hw>]:BB:EUTRa:DL:MBSFn:RHOA.....	623
[SOURce<hw>]:BB:EUTRa:DL:MBSFn:SC:AMODE.....	623
[SOURce<hw>]:BB:EUTRa:DL:MBSFn:SC:AOFFset.....	623
[SOURce<hw>]:BB:EUTRa:DL:MBSFn:SC:APER.....	624
[SOURce<hw>]:BB:EUTRa:DL:MBSFn:SC:AVAL.....	624
[SOURce<hw>]:BB:EUTRa:DL:MBSFn:UEC.....	624
[SOURce<hw>]:BB:EUTRa:DL:MIMO:ANTenna.....	581
[SOURce<hw>]:BB:EUTRa:DL:MIMO:APM:CS:AP<dir0>:ROW<st0>:IMAGinary.....	582
[SOURce<hw>]:BB:EUTRa:DL:MIMO:APM:CS:AP<dir0>:ROW<st0>:REAL.....	582
[SOURce<hw>]:BB:EUTRa:DL:MIMO:APM:CS:CELL:BB<st0>.....	581
[SOURce<hw>]:BB:EUTRa:DL:MIMO:APM:MAPCoordinates.....	581
[SOURce<hw>]:BB:EUTRa:DL:MIMO:CONFiguration.....	581
[SOURce<hw>]:BB:EUTRa:DL:MIMO:NIOT:CONFig.....	831
[SOURce<hw>]:BB:EUTRa:DL:NIOT:ALLoc<ch0>:CCODing:ISF?.....	860
[SOURce<hw>]:BB:EUTRa:DL:NIOT:ALLoc<ch0>:CCODing:NSF?.....	861
[SOURce<hw>]:BB:EUTRa:DL:NIOT:ALLoc<ch0>:CCODing:STATe.....	860
[SOURce<hw>]:BB:EUTRa:DL:NIOT:ALLoc<ch0>:CCODing:TBSI.....	861
[SOURce<hw>]:BB:EUTRa:DL:NIOT:ALLoc<ch0>:CCODing:TBSize?.....	861
[SOURce<hw>]:BB:EUTRa:DL:NIOT:ALLoc<ch0>:CONFlit?.....	857

[SOURce<hw>]:BB:EUTRa:DL:NIOT:ALLOc<ch0>:CONType?	855
[SOURce<hw>]:BB:EUTRa:DL:NIOT:ALLOc<ch0>:DATA	856
[SOURce<hw>]:BB:EUTRa:DL:NIOT:ALLOc<ch0>:DSElect	857
[SOURce<hw>]:BB:EUTRa:DL:NIOT:ALLOc<ch0>:MODulation?	855
[SOURce<hw>]:BB:EUTRa:DL:NIOT:ALLOc<ch0>:PATtern	857
[SOURce<hw>]:BB:EUTRa:DL:NIOT:ALLOc<ch0>:PHYSbits?	856
[SOURce<hw>]:BB:EUTRa:DL:NIOT:ALLOc<ch0>:POWER	856
[SOURce<hw>]:BB:EUTRa:DL:NIOT:ALLOc<ch0>:PRECoding:NOLayers?	858
[SOURce<hw>]:BB:EUTRa:DL:NIOT:ALLOc<ch0>:PRECoding:SCHEME	858
[SOURce<hw>]:BB:EUTRa:DL:NIOT:ALLOc<ch0>:SCRambling:LEGacy:STATe	860
[SOURce<hw>]:BB:EUTRa:DL:NIOT:ALLOc<ch0>:SCRambling:SRoT	859
[SOURce<hw>]:BB:EUTRa:DL:NIOT:ALLOc<ch0>:SCRambling:STATe	859
[SOURce<hw>]:BB:EUTRa:DL:NIOT:ALLOc<ch0>:SCRambling:UEID?	859
[SOURce<hw>]:BB:EUTRa:DL:NIOT:ALLOc<ch0>:SFList?	855
[SOURce<hw>]:BB:EUTRa:DL:NIOT:ALLOc<ch0>:STATe?	857
[SOURce<hw>]:BB:EUTRa:DL:NIOT:ALLOc<ch0>:STSYmbol	855
[SOURce<hw>]:BB:EUTRa:DL:NIOT:CCODing:MIB	861
[SOURce<hw>]:BB:EUTRa:DL:NIOT:CCODing:MSParE	862
[SOURce<hw>]:BB:EUTRa:DL:NIOT:CCODing:NCID?	862
[SOURce<hw>]:BB:EUTRa:DL:NIOT:CCODing:RSIB?	862
[SOURce<hw>]:BB:EUTRa:DL:NIOT:CCODing:SIB	862
[SOURce<hw>]:BB:EUTRa:DL:NIOT:CCODing:SOFFset	863
[SOURce<hw>]:BB:EUTRa:DL:NIOT:CCODing:STFSib1?	863
[SOURce<hw>]:BB:EUTRa:DL:NIOT:DCI:ALLOc<ch0>:BITS?	847
[SOURce<hw>]:BB:EUTRa:DL:NIOT:DCI:ALLOc<ch0>:CCES?	846
[SOURce<hw>]:BB:EUTRa:DL:NIOT:DCI:ALLOc<ch0>:CONFLict?	846
[SOURce<hw>]:BB:EUTRa:DL:NIOT:DCI:ALLOc<ch0>:DIST	854
[SOURce<hw>]:BB:EUTRa:DL:NIOT:DCI:ALLOc<ch0>:FMT	845
[SOURce<hw>]:BB:EUTRa:DL:NIOT:DCI:ALLOc<ch0>:HACK	847
[SOURce<hw>]:BB:EUTRa:DL:NIOT:DCI:ALLOc<ch0>:HPNMber	851
[SOURce<hw>]:BB:EUTRa:DL:NIOT:DCI:ALLOc<ch0>:IDCCe	846
[SOURce<hw>]:BB:EUTRa:DL:NIOT:DCI:ALLOc<ch0>:IDELay	847
[SOURce<hw>]:BB:EUTRa:DL:NIOT:DCI:ALLOc<ch0>:IRU	847
[SOURce<hw>]:BB:EUTRa:DL:NIOT:DCI:ALLOc<ch0>:MCSCHEME	848
[SOURce<hw>]:BB:EUTRa:DL:NIOT:DCI:ALLOc<ch0>:NDINd	848
[SOURce<hw>]:BB:EUTRa:DL:NIOT:DCI:ALLOc<ch0>:NDINd	851
[SOURce<hw>]:BB:EUTRa:DL:NIOT:DCI:ALLOc<ch0>:NPDCch:FMT	845
[SOURce<hw>]:BB:EUTRa:DL:NIOT:DCI:ALLOc<ch0>:NPDCch:OIND	848
[SOURce<hw>]:BB:EUTRa:DL:NIOT:DCI:ALLOc<ch0>:NPDCch:REP?	848
[SOURce<hw>]:BB:EUTRa:DL:NIOT:DCI:ALLOc<ch0>:NPDSch:IREP	849
[SOURce<hw>]:BB:EUTRa:DL:NIOT:DCI:ALLOc<ch0>:NPDSch:ISF	849
[SOURce<hw>]:BB:EUTRa:DL:NIOT:DCI:ALLOc<ch0>:NPDSch:NREP?	849
[SOURce<hw>]:BB:EUTRa:DL:NIOT:DCI:ALLOc<ch0>:NPDSch:NSF?	850
[SOURce<hw>]:BB:EUTRa:DL:NIOT:DCI:ALLOc<ch0>:NPRach:SCINd	850
[SOURce<hw>]:BB:EUTRa:DL:NIOT:DCI:ALLOc<ch0>:NPRach:SNUMber	850
[SOURce<hw>]:BB:EUTRa:DL:NIOT:DCI:ALLOc<ch0>:NPUSch:IREP	850
[SOURce<hw>]:BB:EUTRa:DL:NIOT:DCI:ALLOc<ch0>:NRUNits?	851
[SOURce<hw>]:BB:EUTRa:DL:NIOT:DCI:ALLOc<ch0>:PAG	852
[SOURce<hw>]:BB:EUTRa:DL:NIOT:DCI:ALLOc<ch0>:RVERsion	852
[SOURce<hw>]:BB:EUTRa:DL:NIOT:DCI:ALLOc<ch0>:SCINd	852

[SOURce<hw>]:BB:EUTRa:DL:NIOT:DCI:ALLoc<ch0>:SFRPt.....	852
[SOURce<hw>]:BB:EUTRa:DL:NIOT:DCI:ALLoc<ch0>:SIME.....	853
[SOURce<hw>]:BB:EUTRa:DL:NIOT:DCI:ALLoc<ch0>:SINF.....	853
[SOURce<hw>]:BB:EUTRa:DL:NIOT:DCI:ALLoc<ch0>:SSP.....	845
[SOURce<hw>]:BB:EUTRa:DL:NIOT:DCI:ALLoc<ch0>:STSFrame.....	845
[SOURce<hw>]:BB:EUTRa:DL:NIOT:DCI:ALLoc<ch0>:TBSZ?.....	853
[SOURce<hw>]:BB:EUTRa:DL:NIOT:DCI:ALLoc<ch0>:UEID?.....	844
[SOURce<hw>]:BB:EUTRa:DL:NIOT:DCI:ALLoc<ch0>:USER.....	844
[SOURce<hw>]:BB:EUTRa:DL:NIOT:DCI:AWARound.....	844
[SOURce<hw>]:BB:EUTRa:DL:NIOT:DCI:NALLoc.....	844
[SOURce<hw>]:BB:EUTRa:DL:NIOT:GAP:CONFig:STATe.....	832
[SOURce<hw>]:BB:EUTRa:DL:NIOT:GAP:DURation:COEFficient.....	833
[SOURce<hw>]:BB:EUTRa:DL:NIOT:GAP:PERiodicity.....	833
[SOURce<hw>]:BB:EUTRa:DL:NIOT:GAP:THReshold.....	833
[SOURce<hw>]:BB:EUTRa:DL:NIOT:ID?.....	835
[SOURce<hw>]:BB:EUTRa:DL:NIOT:LTECell:STATe.....	832
[SOURce<hw>]:BB:EUTRa:DL:NIOT:NALLoc?.....	854
[SOURce<hw>]:BB:EUTRa:DL:NIOT:NPRS:BMP:CONF.....	827
[SOURce<hw>]:BB:EUTRa:DL:NIOT:NPRS:BMP:VALSubframes<ch>.....	827
[SOURce<hw>]:BB:EUTRa:DL:NIOT:NPRS:CONF.....	826
[SOURce<hw>]:BB:EUTRa:DL:NIOT:NPRS:ID.....	826
[SOURce<hw>]:BB:EUTRa:DL:NIOT:NPRS:MTIA.....	827
[SOURce<hw>]:BB:EUTRa:DL:NIOT:NPRS:MTIB.....	827
[SOURce<hw>]:BB:EUTRa:DL:NIOT:NPRS:PERiod.....	828
[SOURce<hw>]:BB:EUTRa:DL:NIOT:NPRS:POW.....	826
[SOURce<hw>]:BB:EUTRa:DL:NIOT:NPRS:SEIN.....	826
[SOURce<hw>]:BB:EUTRa:DL:NIOT:NPRS:SFNM.....	828
[SOURce<hw>]:BB:EUTRa:DL:NIOT:NPRS:STATe.....	825
[SOURce<hw>]:BB:EUTRa:DL:NIOT:NPRS:STSFrame.....	828
[SOURce<hw>]:BB:EUTRa:DL:NIOT:PAG:RMAX.....	837
[SOURce<hw>]:BB:EUTRa:DL:NIOT:PUNcTure.....	832
[SOURce<hw>]:BB:EUTRa:DL:NIOT:RAND:RMAX.....	837
[SOURce<hw>]:BB:EUTRa:DL:NIOT:RAND:SSOffset.....	837
[SOURce<hw>]:BB:EUTRa:DL:NIOT:RAND:STSFrame.....	837
[SOURce<hw>]:BB:EUTRa:DL:NIOT:WUS:ACD.....	829
[SOURce<hw>]:BB:EUTRa:DL:NIOT:WUS:MAXDuration.....	829
[SOURce<hw>]:BB:EUTRa:DL:NIOT:WUS:POW.....	829
[SOURce<hw>]:BB:EUTRa:DL:NIOT:WUS:PSF?.....	830
[SOURce<hw>]:BB:EUTRa:DL:NIOT:WUS:SF.....	830
[SOURce<hw>]:BB:EUTRa:DL:NIOT:WUS:STATe.....	830
[SOURce<hw>]:BB:EUTRa:DL:NIOT:WUS:TO.....	831
[SOURce<hw>]:BB:EUTRa:DL:NORB.....	585
[SOURce<hw>]:BB:EUTRa:DL:OCCBandwidth?.....	586
[SOURce<hw>]:BB:EUTRa:DL:OCCSubcarriers?.....	586
[SOURce<hw>]:BB:EUTRa:DL:PBCH:MIB.....	648
[SOURce<hw>]:BB:EUTRa:DL:PBCH:MSPare.....	649
[SOURce<hw>]:BB:EUTRa:DL:PBCH:RATBa.....	589
[SOURce<hw>]:BB:EUTRa:DL:PBCH:SOFFset.....	648
[SOURce<hw>]:BB:EUTRa:DL:PBCH:SRPeriod.....	648
[SOURce<hw>]:BB:EUTRa:DL:PDCCh:RATBa.....	589

[SOURce<hw>]:BB:EUTRa:DL:PDsch:PB.....	588
[SOURce<hw>]:BB:EUTRa:DL:PDsch:RATBa.....	589
[SOURce<hw>]:BB:EUTRa:DL:PRSS:BW.....	589
[SOURce<hw>]:BB:EUTRa:DL:PRSS:Cl.....	589
[SOURce<hw>]:BB:EUTRa:DL:PRSS:DPRS?.....	590
[SOURce<hw>]:BB:EUTRa:DL:PRSS:MIPattern.....	591
[SOURce<hw>]:BB:EUTRa:DL:PRSS:NPRS.....	590
[SOURce<hw>]:BB:EUTRa:DL:PRSS:POW.....	590
[SOURce<hw>]:BB:EUTRa:DL:PRSS:STATe.....	591
[SOURce<hw>]:BB:EUTRa:DL:PRSS:TPRS?.....	591
[SOURce<hw>]:BB:EUTRa:DL:REFSig:EPRE?.....	583
[SOURce<hw>]:BB:EUTRa:DL:REFSig:NIOT:POWer.....	824
[SOURce<hw>]:BB:EUTRa:DL:REFSig:POWer.....	583
[SOURce<hw>]:BB:EUTRa:DL:RGS?.....	586
[SOURce<hw>]:BB:EUTRa:DL:RSTFrame.....	605
[SOURce<hw>]:BB:EUTRa:DL:SRATe?.....	585
[SOURce<hw>]:BB:EUTRa:DL:SYNC:NIOT:NPPWr.....	825
[SOURce<hw>]:BB:EUTRa:DL:SYNC:NIOT:NSPW.....	825
[SOURce<hw>]:BB:EUTRa:DL:SYNC:NIOT:TXAntenna.....	824
[SOURce<hw>]:BB:EUTRa:DL:SYNC:PPOWer.....	584
[SOURce<hw>]:BB:EUTRa:DL:SYNC:SPOWer.....	584
[SOURce<hw>]:BB:EUTRa:DL:SYNC:TXAntenna.....	584
[SOURce<hw>]:BB:EUTRa:DL:ULCPc.....	588
[SOURce<hw>]:BB:EUTRa:DL:USER<ch>:APM:CBCI.....	729
[SOURce<hw>]:BB:EUTRa:DL:USER<ch>:APM:CBIndex[<dir>].....	730
[SOURce<hw>]:BB:EUTRa:DL:USER<ch>:APM:CBUA.....	729
[SOURce<hw>]:BB:EUTRa:DL:USER<ch>:APM:CELL.....	729
[SOURce<hw>]:BB:EUTRa:DL:USER<ch>:APM:MAPCoordinates.....	730
[SOURce<hw>]:BB:EUTRa:DL:USER<ch>:APM:MODE.....	731
[SOURce<hw>]:BB:EUTRa:DL:USER<ch>:APM[:LAYer<user>]:AP<dir0>:BB<st0>:IMAGinary.....	731
[SOURce<hw>]:BB:EUTRa:DL:USER<ch>:APM[:LAYer<user>]:AP<dir0>:BB<st0>:REAL.....	731
[SOURce<hw>]:BB:EUTRa:DL:USER<ch>:AS:APPLY.....	694
[SOURce<hw>]:BB:EUTRa:DL:USER<ch>:AS:ARBLen?.....	692
[SOURce<hw>]:BB:EUTRa:DL:USER<ch>:AS:ASLength.....	692
[SOURce<hw>]:BB:EUTRa:DL:USER<ch>:AS:DL:AFSeq.....	692
[SOURce<hw>]:BB:EUTRa:DL:USER<ch>:AS:DL:CELL<st0>:APPend.....	700
[SOURce<hw>]:BB:EUTRa:DL:USER<ch>:AS:DL:CELL<st0>:DELete.....	701
[SOURce<hw>]:BB:EUTRa:DL:USER<ch>:AS:DL:CELL<st0>:FMCS.....	694
[SOURce<hw>]:BB:EUTRa:DL:USER<ch>:AS:DL:CELL<st0>:INSert.....	700
[SOURce<hw>]:BB:EUTRa:DL:USER<ch>:AS:DL:CELL<st0>:MCsMode.....	694
[SOURce<hw>]:BB:EUTRa:DL:USER<ch>:AS:DL:CELL<st0>:RESet.....	701
[SOURce<hw>]:BB:EUTRa:DL:USER<ch>:AS:DL:CELL<st0>:RVCSequence.....	695
[SOURce<hw>]:BB:EUTRa:DL:USER<ch>:AS:DL:CELL<st0>:SELelement.....	700
[SOURce<hw>]:BB:EUTRa:DL:USER<ch>:AS:DL:CELL<st0>:SEQelem<dir0>:CONFLict?.....	698
[SOURce<hw>]:BB:EUTRa:DL:USER<ch>:AS:DL:CELL<st0>:SEQelem<dir0>:HARQ.....	695
[SOURce<hw>]:BB:EUTRa:DL:USER<ch>:AS:DL:CELL<st0>:SEQelem<dir0>:PDRE.....	696
[SOURce<hw>]:BB:EUTRa:DL:USER<ch>:AS:DL:CELL<st0>:SEQelem<dir0>:SUBFrame.....	697
[SOURce<hw>]:BB:EUTRa:DL:USER<ch>:AS:DL:CELL<st0>:SEQelem<dir0>:TB1:MCS.....	697
[SOURce<hw>]:BB:EUTRa:DL:USER<ch>:AS:DL:CELL<st0>:SEQelem<dir0>:TB1:NDI.....	697
[SOURce<hw>]:BB:EUTRa:DL:USER<ch>:AS:DL:CELL<st0>:SEQelem<dir0>:TB1:RLCCounter.....	698

[SOURce<hw>]:BB:EUTRa:DL:USER<ch>:AS:DL:CELL<st0>:SEQelem<dir0>:TB1:RV.....	698
[SOURce<hw>]:BB:EUTRa:DL:USER<ch>:AS:DL:CELL<st0>:SEQelem<dir0>:TB2:MCS.....	697
[SOURce<hw>]:BB:EUTRa:DL:USER<ch>:AS:DL:CELL<st0>:SEQelem<dir0>:TB2:NDI.....	697
[SOURce<hw>]:BB:EUTRa:DL:USER<ch>:AS:DL:CELL<st0>:SEQelem<dir0>:TB2:RLCCounter.....	698
[SOURce<hw>]:BB:EUTRa:DL:USER<ch>:AS:DL:CELL<st0>:SEQelem<dir0>:TB2:RV.....	698
[SOURce<hw>]:BB:EUTRa:DL:USER<ch>:AS:DL:CELL<st0>:SLENgth?.....	696
[SOURce<hw>]:BB:EUTRa:DL:USER<ch>:AS:DL:CELL<st0>:TCR.....	695
[SOURce<hw>]:BB:EUTRa:DL:USER<ch>:AS:DL:CELL<st0>:TMOD.....	695
[SOURce<hw>]:BB:EUTRa:DL:USER<ch>:AS:DL:CELL<st0>:URLCounter.....	698
[SOURce<hw>]:BB:EUTRa:DL:USER<ch>:AS:DL:INDI.....	693
[SOURce<hw>]:BB:EUTRa:DL:USER<ch>:AS:DL:NHIDs.....	692
[SOURce<hw>]:BB:EUTRa:DL:USER<ch>:AS:DL:NHTRans.....	693
[SOURce<hw>]:BB:EUTRa:DL:USER<ch>:AS:DL:SKPRocess.....	693
[SOURce<hw>]:BB:EUTRa:DL:USER<ch>:AS:DL[CELL<ccidx>]:USUBframe<dir0>.....	694
[SOURce<hw>]:BB:EUTRa:DL:USER<ch>:AS:UL:AFSeq.....	692
[SOURce<hw>]:BB:EUTRa:DL:USER<ch>:AS:UL:CELL<st0>:APPend.....	700
[SOURce<hw>]:BB:EUTRa:DL:USER<ch>:AS:UL:CELL<st0>:DElete.....	701
[SOURce<hw>]:BB:EUTRa:DL:USER<ch>:AS:UL:CELL<st0>:INSert.....	700
[SOURce<hw>]:BB:EUTRa:DL:USER<ch>:AS:UL:CELL<st0>:RESet.....	701
[SOURce<hw>]:BB:EUTRa:DL:USER<ch>:AS:UL:CELL<st0>:SElement.....	700
[SOURce<hw>]:BB:EUTRa:DL:USER<ch>:AS:UL:CELL<st0>:SEQelem<dir0>:CONFLict?.....	698
[SOURce<hw>]:BB:EUTRa:DL:USER<ch>:AS:UL:CELL<st0>:SEQelem<dir0>:NDI.....	697
[SOURce<hw>]:BB:EUTRa:DL:USER<ch>:AS:UL:CELL<st0>:SEQelem<dir0>:PTPC.....	699
[SOURce<hw>]:BB:EUTRa:DL:USER<ch>:AS:UL:CELL<st0>:SEQelem<dir0>:RBA.....	699
[SOURce<hw>]:BB:EUTRa:DL:USER<ch>:AS:UL:CELL<st0>:SEQelem<dir0>:SUBFrame.....	697
[SOURce<hw>]:BB:EUTRa:DL:USER<ch>:AS:UL:CELL<st0>:SEQelem<dir0>:ULINdex.....	699
[SOURce<hw>]:BB:EUTRa:DL:USER<ch>:AS:UL:CELL<st0>:SLENgth?.....	696
[SOURce<hw>]:BB:EUTRa:DL:USER<ch>:AS:UL:CELL<st0>:VULTxpow.....	700
[SOURce<hw>]:BB:EUTRa:DL:USER<ch>:AS:UL:INDI.....	693
[SOURce<hw>]:BB:EUTRa:DL:USER<ch>:AS:UL:NHTRans.....	693
[SOURce<hw>]:BB:EUTRa:DL:USER<ch>:ASRS:STATe.....	734
[SOURce<hw>]:BB:EUTRa:DL:USER<ch>:CA:STATe.....	728
[SOURce<hw>]:BB:EUTRa:DL:USER<ch>:CAW:STATe.....	734
[SOURce<hw>]:BB:EUTRa:DL:USER<ch>:CCODing:STATe.....	732
[SOURce<hw>]:BB:EUTRa:DL:USER<ch>:CELL<st0>:DMRS:STATe.....	736
[SOURce<hw>]:BB:EUTRa:DL:USER<ch>:CELL<st0>:MCS.....	735
[SOURce<hw>]:BB:EUTRa:DL:USER<ch>:CELL<st0>:SEOL:STATe.....	736
[SOURce<hw>]:BB:EUTRa:DL:USER<ch>:CELL<st0>:TBAL.....	735
[SOURce<hw>]:BB:EUTRa:DL:USER<ch>:CELL<st0>:TXM.....	728
[SOURce<hw>]:BB:EUTRa:DL:USER<ch>:DATA.....	732
[SOURce<hw>]:BB:EUTRa:DL:USER<ch>:DSElect.....	733
[SOURce<hw>]:BB:EUTRa:DL:USER<ch>:EIMTarti.....	734
[SOURce<hw>]:BB:EUTRa:DL:USER<ch>:EPDCch:CELL<st0>:SET<dir>:HOPPing.....	891
[SOURce<hw>]:BB:EUTRa:DL:USER<ch>:EPDCch:CELL<st0>:SET<dir>:NID.....	741
[SOURce<hw>]:BB:EUTRa:DL:USER<ch>:EPDCch:CELL<st0>:SET<dir>:POWER.....	742
[SOURce<hw>]:BB:EUTRa:DL:USER<ch>:EPDCch:CELL<st0>:SET<dir>:PRBS.....	741
[SOURce<hw>]:BB:EUTRa:DL:USER<ch>:EPDCch:CELL<st0>:SET<dir>:RBA.....	741
[SOURce<hw>]:BB:EUTRa:DL:USER<ch>:EPDCch:CELL<st0>:SET<dir>:REPMpdcc.....	892
[SOURce<hw>]:BB:EUTRa:DL:USER<ch>:EPDCch:CELL<st0>:SET<dir>:STATe.....	740
[SOURce<hw>]:BB:EUTRa:DL:USER<ch>:EPDCch:CELL<st0>:SET<dir>:STNB.....	892

[SOURce<hw>]:BB:EUTRa:DL:USER<ch>:EPDCch:CELL<st0>:SET<dir>:STSF	892
[SOURce<hw>]:BB:EUTRa:DL:USER<ch>:EPDCch:CELL<st0>:SET<dir>:TTYP	740
[SOURce<hw>]:BB:EUTRa:DL:USER<ch>:EPDCch:CELL<st0>:STATE	740
[SOURce<hw>]:BB:EUTRa:DL:USER<ch>:INITpattern	733
[SOURce<hw>]:BB:EUTRa:DL:USER<ch>:MCSTwo:STATE	735
[SOURce<hw>]:BB:EUTRa:DL:USER<ch>:NIOT:RMAX	864
[SOURce<hw>]:BB:EUTRa:DL:USER<ch>:NIOT:SSOFFset	864
[SOURce<hw>]:BB:EUTRa:DL:USER<ch>:NIOT:STSFrame	864
[SOURce<hw>]:BB:EUTRa:DL:USER<ch>:PA	734
[SOURce<hw>]:BB:EUTRa:DL:USER<ch>:PATtern	733
[SOURce<hw>]:BB:EUTRa:DL:USER<ch>:RELease	863
[SOURce<hw>]:BB:EUTRa:DL:USER<ch>:SCRambling:CELL<st>:DMRS:ID1	738
[SOURce<hw>]:BB:EUTRa:DL:USER<ch>:SCRambling:CELL<st>:DMRS:ID2	738
[SOURce<hw>]:BB:EUTRa:DL:USER<ch>:SCRambling:CELL<st>:DMRS:USE	737
[SOURce<hw>]:BB:EUTRa:DL:USER<ch>:SCRambling:STATE	737
[SOURce<hw>]:BB:EUTRa:DL:USER<ch>:SPS:CRNTi	745
[SOURce<hw>]:BB:EUTRa:DL:USER<ch>:SPS:SACTivation	745
[SOURce<hw>]:BB:EUTRa:DL:USER<ch>:SPS:SINTerval	745
[SOURce<hw>]:BB:EUTRa:DL:USER<ch>:SPS:SRELease	745
[SOURce<hw>]:BB:EUTRa:DL:USER<ch>:SPS:STATE	744
[SOURce<hw>]:BB:EUTRa:DL:USER<ch>:STATE	727
[SOURce<hw>]:BB:EUTRa:DL:USER<ch>:STHP:STATE	736
[SOURce<hw>]:BB:EUTRa:DL:USER<ch>:TALIndex:STATE	736
[SOURce<hw>]:BB:EUTRa:DL:USER<ch>:TXM	728
[SOURce<hw>]:BB:EUTRa:DL:USER<ch>:UEC	728
[SOURce<hw>]:BB:EUTRa:DL:USER<ch>:UEID	732
[SOURce<hw>]:BB:EUTRa:DL:USER<ch>:ULCA<st0>:STATE	729
[SOURce<hw>]:BB:EUTRa:DL[:CELL<ccid>]:[:SUBF<st0>]:ALLoc<ch0>:PUSCh:PRECoding:CBUA	652
[SOURce<hw>]:BB:EUTRa:DL[:PLCI]:CID	587
[SOURce<hw>]:BB:EUTRa:DL[:PLCI]:CIDGroup	587
[SOURce<hw>]:BB:EUTRa:DL[:PLCI]:PLID	587
[SOURce<hw>]:BB:EUTRa:DL[:SUBF<st0>]:ALCount	606
[SOURce<hw>]:BB:EUTRa:DL[:SUBF<st0>]:ALLoc<ch0>:CAW	649
[SOURce<hw>]:BB:EUTRa:DL[:SUBF<st0>]:ALLoc<ch0>:CODWords	606
[SOURce<hw>]:BB:EUTRa:DL[:SUBF<st0>]:ALLoc<ch0>[:CW<user>]:AOC	609
[SOURce<hw>]:BB:EUTRa:DL[:SUBF<st0>]:ALLoc<ch0>[:CW<user>]:CCODing:ISBSize	649
[SOURce<hw>]:BB:EUTRa:DL[:SUBF<st0>]:ALLoc<ch0>[:CW<user>]:CCODing:RVINdex	650
[SOURce<hw>]:BB:EUTRa:DL[:SUBF<st0>]:ALLoc<ch0>[:CW<user>]:CCODing:STATE	650
[SOURce<hw>]:BB:EUTRa:DL[:SUBF<st0>]:ALLoc<ch0>[:CW<user>]:CCODing:TBSize	650
[SOURce<hw>]:BB:EUTRa:DL[:SUBF<st0>]:ALLoc<ch0>[:CW<user>]:CONFLICT	612
[SOURce<hw>]:BB:EUTRa:DL[:SUBF<st0>]:ALLoc<ch0>[:CW<user>]:CONType?	611
[SOURce<hw>]:BB:EUTRa:DL[:SUBF<st0>]:ALLoc<ch0>[:CW<user>]:DATA	609
[SOURce<hw>]:BB:EUTRa:DL[:SUBF<st0>]:ALLoc<ch0>[:CW<user>]:DSElect	610
[SOURce<hw>]:BB:EUTRa:DL[:SUBF<st0>]:ALLoc<ch0>[:CW<user>]:GAP	607
[SOURce<hw>]:BB:EUTRa:DL[:SUBF<st0>]:ALLoc<ch0>[:CW<user>]:MODulation	606
[SOURce<hw>]:BB:EUTRa:DL[:SUBF<st0>]:ALLoc<ch0>[:CW<user>]:PATtern	610
[SOURce<hw>]:BB:EUTRa:DL[:SUBF<st0>]:ALLoc<ch0>[:CW<user>]:PHYSbits?	609
[SOURce<hw>]:BB:EUTRa:DL[:SUBF<st0>]:ALLoc<ch0>[:CW<user>]:POWER	611
[SOURce<hw>]:BB:EUTRa:DL[:SUBF<st0>]:ALLoc<ch0>[:CW<user>]:PRECoding:AP	651
[SOURce<hw>]:BB:EUTRa:DL[:SUBF<st0>]:ALLoc<ch0>[:CW<user>]:PRECoding:APM	651

[SOURce<hw>]:BB:EUTRa:DL[:SUBF<st0>]:ALLoc<ch0>[:CW<user>]:PRECoding:CBINdex[<dir>].....	652
[SOURce<hw>]:BB:EUTRa:DL[:SUBF<st0>]:ALLoc<ch0>[:CW<user>]:PRECoding:CDD.....	653
[SOURce<hw>]:BB:EUTRa:DL[:SUBF<st0>]:ALLoc<ch0>[:CW<user>]:PRECoding:DAFormat.....	653
[SOURce<hw>]:BB:EUTRa:DL[:SUBF<st0>]:ALLoc<ch0>[:CW<user>]:PRECoding:NOLayers.....	653
[SOURce<hw>]:BB:EUTRa:DL[:SUBF<st0>]:ALLoc<ch0>[:CW<user>]:PRECoding:SCHeme.....	654
[SOURce<hw>]:BB:EUTRa:DL[:SUBF<st0>]:ALLoc<ch0>[:CW<user>]:PRECoding:SCID.....	654
[SOURce<hw>]:BB:EUTRa:DL[:SUBF<st0>]:ALLoc<ch0>[:CW<user>]:PRECoding:TRSCHEME.....	655
[SOURce<hw>]:BB:EUTRa:DL[:SUBF<st0>]:ALLoc<ch0>[:CW<user>]:RBCount.....	607
[SOURce<hw>]:BB:EUTRa:DL[:SUBF<st0>]:ALLoc<ch0>[:CW<user>]:RBOffset.....	608
[SOURce<hw>]:BB:EUTRa:DL[:SUBF<st0>]:ALLoc<ch0>[:CW<user>]:SCRambling:STATE.....	655
[SOURce<hw>]:BB:EUTRa:DL[:SUBF<st0>]:ALLoc<ch0>[:CW<user>]:SCRambling:UEID.....	655
[SOURce<hw>]:BB:EUTRa:DL[:SUBF<st0>]:ALLoc<ch0>[:CW<user>]:STATE.....	612
[SOURce<hw>]:BB:EUTRa:DL[:SUBF<st0>]:ALLoc<ch0>[:CW<user>]:SYMCount.....	608
[SOURce<hw>]:BB:EUTRa:DL[:SUBF<st0>]:ALLoc<ch0>[:CW<user>]:SYMOffset.....	608
[SOURce<hw>]:BB:EUTRa:DL[:SUBF<st0>]:CYCPrefix.....	605
[SOURce<hw>]:BB:EUTRa:DL[:SUBF<st0>]:ENCC:PCFich:CREGion.....	660
[SOURce<hw>]:BB:EUTRa:DL[:SUBF<st0>]:ENCC:PCFich:POWER.....	659
[SOURce<hw>]:BB:EUTRa:DL[:SUBF<st0>]:ENCC:PDCCh:ALRegs.....	665
[SOURce<hw>]:BB:EUTRa:DL[:SUBF<st0>]:ENCC:PDCCh:AVCCes.....	663
[SOURce<hw>]:BB:EUTRa:DL[:SUBF<st0>]:ENCC:PDCCh:AVRegs.....	663
[SOURce<hw>]:BB:EUTRa:DL[:SUBF<st0>]:ENCC:PDCCh:BITS.....	663
[SOURce<hw>]:BB:EUTRa:DL[:SUBF<st0>]:ENCC:PDCCh:DATA.....	665
[SOURce<hw>]:BB:EUTRa:DL[:SUBF<st0>]:ENCC:PDCCh:DCRegs:DATA.....	667
[SOURce<hw>]:BB:EUTRa:DL[:SUBF<st0>]:ENCC:PDCCh:DCRegs:DSElect.....	667
[SOURce<hw>]:BB:EUTRa:DL[:SUBF<st0>]:ENCC:PDCCh:DCRegs:PATtern.....	667
[SOURce<hw>]:BB:EUTRa:DL[:SUBF<st0>]:ENCC:PDCCh:DCRegs:TRSource.....	666
[SOURce<hw>]:BB:EUTRa:DL[:SUBF<st0>]:ENCC:PDCCh:DREGs.....	665
[SOURce<hw>]:BB:EUTRa:DL[:SUBF<st0>]:ENCC:PDCCh:DSElect.....	666
[SOURce<hw>]:BB:EUTRa:DL[:SUBF<st0>]:ENCC:PDCCh:EXTC:APPend.....	668
[SOURce<hw>]:BB:EUTRa:DL[:SUBF<st0>]:ENCC:PDCCh:EXTC:CONFLict?.....	669
[SOURce<hw>]:BB:EUTRa:DL[:SUBF<st0>]:ENCC:PDCCh:EXTC:DELete.....	668
[SOURce<hw>]:BB:EUTRa:DL[:SUBF<st0>]:ENCC:PDCCh:EXTC:DOWN.....	669
[SOURce<hw>]:BB:EUTRa:DL[:SUBF<st0>]:ENCC:PDCCh:EXTC:INSert.....	668
[SOURce<hw>]:BB:EUTRa:DL[:SUBF<st0>]:ENCC:PDCCh:EXTC:ITEM<ch0>:CELL.....	672
[SOURce<hw>]:BB:EUTRa:DL[:SUBF<st0>]:ENCC:PDCCh:EXTC:ITEM<ch0>:CINdex.....	673
[SOURce<hw>]:BB:EUTRa:DL[:SUBF<st0>]:ENCC:PDCCh:EXTC:ITEM<ch0>:CONFLict?.....	675
[SOURce<hw>]:BB:EUTRa:DL[:SUBF<st0>]:ENCC:PDCCh:EXTC:ITEM<ch0>:DCIConf:APLayer.....	675
[SOURce<hw>]:BB:EUTRa:DL[:SUBF<st0>]:ENCC:PDCCh:EXTC:ITEM<ch0>:DCIConf:BITData?.....	676
[SOURce<hw>]:BB:EUTRa:DL[:SUBF<st0>]:ENCC:PDCCh:EXTC:ITEM<ch0>:DCIConf:CIField.....	676
[SOURce<hw>]:BB:EUTRa:DL[:SUBF<st0>]:ENCC:PDCCh:EXTC:ITEM<ch0>:DCIConf:CSDMrs.....	678
[SOURce<hw>]:BB:EUTRa:DL[:SUBF<st0>]:ENCC:PDCCh:EXTC:ITEM<ch0>:DCIConf:CSIRequest.....	678
[SOURce<hw>]:BB:EUTRa:DL[:SUBF<st0>]:ENCC:PDCCh:EXTC:ITEM<ch0>:DCIConf:DLAindex.....	678
[SOURce<hw>]:BB:EUTRa:DL[:SUBF<st0>]:ENCC:PDCCh:EXTC:ITEM<ch0>:DCIConf:DPOffset.....	679
[SOURce<hw>]:BB:EUTRa:DL[:SUBF<st0>]:ENCC:PDCCh:EXTC:ITEM<ch0>:DCIConf:F1AMode.....	676
[SOURce<hw>]:BB:EUTRa:DL[:SUBF<st0>]:ENCC:PDCCh:EXTC:ITEM<ch0>:DCIConf:GAP.....	679
[SOURce<hw>]:BB:EUTRa:DL[:SUBF<st0>]:ENCC:PDCCh:EXTC:ITEM<ch0>:DCIConf:HACK.....	680
[SOURce<hw>]:BB:EUTRa:DL[:SUBF<st0>]:ENCC:PDCCh:EXTC:ITEM<ch0>:DCIConf:HPN.....	679
[SOURce<hw>]:BB:EUTRa:DL[:SUBF<st0>]:ENCC:PDCCh:EXTC:ITEM<ch0>:DCIConf:LAASubframe..	647
[SOURce<hw>]:BB:EUTRa:DL[:SUBF<st0>]:ENCC:PDCCh:EXTC:ITEM<ch0>:DCIConf:MCSR.....	680
[SOURce<hw>]:BB:EUTRa:DL[:SUBF<st0>]:ENCC:PDCCh:EXTC:ITEM<ch0>:DCIConf:NDI.....	681

[;SOURce<hw>]:BB:EUTRa:DL[:SUBF<st0>]:ENCC:PDCCh:EXTC:ITEM<ch0>:DCIConf:PDRE.....	681
[;SOURce<hw>]:BB:EUTRa:DL[:SUBF<st0>]:ENCC:PDCCh:EXTC:ITEM<ch0>:DCIConf:PFHopping.....	682
[;SOURce<hw>]:BB:EUTRa:DL[:SUBF<st0>]:ENCC:PDCCh:EXTC:ITEM<ch0>:DCIConf:PMI.....	682
[;SOURce<hw>]:BB:EUTRa:DL[:SUBF<st0>]:ENCC:PDCCh:EXTC:ITEM<ch0>:DCIConf:PRACH: MINDex.....	677
[;SOURce<hw>]:BB:EUTRa:DL[:SUBF<st0>]:ENCC:PDCCh:EXTC:ITEM<ch0>:DCIConf:PRACH: PRINdex.....	677
[;SOURce<hw>]:BB:EUTRa:DL[:SUBF<st0>]:ENCC:PDCCh:EXTC:ITEM<ch0>:DCIConf:PREInfo.....	682
[;SOURce<hw>]:BB:EUTRa:DL[:SUBF<st0>]:ENCC:PDCCh:EXTC:ITEM<ch0>:DCIConf:RAH.....	683
[;SOURce<hw>]:BB:EUTRa:DL[:SUBF<st0>]:ENCC:PDCCh:EXTC:ITEM<ch0>:DCIConf:RAHR.....	683
[;SOURce<hw>]:BB:EUTRa:DL[:SUBF<st0>]:ENCC:PDCCh:EXTC:ITEM<ch0>:DCIConf:RAType.....	684
[;SOURce<hw>]:BB:EUTRa:DL[:SUBF<st0>]:ENCC:PDCCh:EXTC:ITEM<ch0>:DCIConf:RBA.....	684
[;SOURce<hw>]:BB:EUTRa:DL[:SUBF<st0>]:ENCC:PDCCh:EXTC:ITEM<ch0>:DCIConf:RV.....	684
[;SOURce<hw>]:BB:EUTRa:DL[:SUBF<st0>]:ENCC:PDCCh:EXTC:ITEM<ch0>:DCIConf:SID.....	686
[;SOURce<hw>]:BB:EUTRa:DL[:SUBF<st0>]:ENCC:PDCCh:EXTC:ITEM<ch0>:DCIConf:SRSRequest....	684
[;SOURce<hw>]:BB:EUTRa:DL[:SUBF<st0>]:ENCC:PDCCh:EXTC:ITEM<ch0>:DCIConf:SWAPflag.....	685
[;SOURce<hw>]:BB:EUTRa:DL[:SUBF<st0>]:ENCC:PDCCh:EXTC:ITEM<ch0>:DCIConf:TB1:MCS.....	685
[;SOURce<hw>]:BB:EUTRa:DL[:SUBF<st0>]:ENCC:PDCCh:EXTC:ITEM<ch0>:DCIConf:TB1:NDI.....	685
[;SOURce<hw>]:BB:EUTRa:DL[:SUBF<st0>]:ENCC:PDCCh:EXTC:ITEM<ch0>:DCIConf:TB1:RV.....	686
[;SOURce<hw>]:BB:EUTRa:DL[:SUBF<st0>]:ENCC:PDCCh:EXTC:ITEM<ch0>:DCIConf:TB2:MCS.....	685
[;SOURce<hw>]:BB:EUTRa:DL[:SUBF<st0>]:ENCC:PDCCh:EXTC:ITEM<ch0>:DCIConf:TB2:NDI.....	685
[;SOURce<hw>]:BB:EUTRa:DL[:SUBF<st0>]:ENCC:PDCCh:EXTC:ITEM<ch0>:DCIConf:TB2:RV.....	686
[;SOURce<hw>]:BB:EUTRa:DL[:SUBF<st0>]:ENCC:PDCCh:EXTC:ITEM<ch0>:DCIConf:TPCC.....	687
[;SOURce<hw>]:BB:EUTRa:DL[:SUBF<st0>]:ENCC:PDCCh:EXTC:ITEM<ch0>:DCIConf:TPCInstr.....	687
[;SOURce<hw>]:BB:EUTRa:DL[:SUBF<st0>]:ENCC:PDCCh:EXTC:ITEM<ch0>:DCIConf:TPMI.....	687
[;SOURce<hw>]:BB:EUTRa:DL[:SUBF<st0>]:ENCC:PDCCh:EXTC:ITEM<ch0>:DCIConf:ULDLconf.....	688
[;SOURce<hw>]:BB:EUTRa:DL[:SUBF<st0>]:ENCC:PDCCh:EXTC:ITEM<ch0>:DCIConf:ULINdex.....	688
[;SOURce<hw>]:BB:EUTRa:DL[:SUBF<st0>]:ENCC:PDCCh:EXTC:ITEM<ch0>:DCIConf:VRBA.....	689
[;SOURce<hw>]:BB:EUTRa:DL[:SUBF<st0>]:ENCC:PDCCh:EXTC:ITEM<ch0>:DCIFmt.....	671
[;SOURce<hw>]:BB:EUTRa:DL[:SUBF<st0>]:ENCC:PDCCh:EXTC:ITEM<ch0>:NCCes?.....	672
[;SOURce<hw>]:BB:EUTRa:DL[:SUBF<st0>]:ENCC:PDCCh:EXTC:ITEM<ch0>:NDCCes?.....	673
[;SOURce<hw>]:BB:EUTRa:DL[:SUBF<st0>]:ENCC:PDCCh:EXTC:ITEM<ch0>:PDCChType.....	673
[;SOURce<hw>]:BB:EUTRa:DL[:SUBF<st0>]:ENCC:PDCCh:EXTC:ITEM<ch0>:PFMT.....	672
[;SOURce<hw>]:BB:EUTRa:DL[:SUBF<st0>]:ENCC:PDCCh:EXTC:ITEM<ch0>:SESPace.....	674
[;SOURce<hw>]:BB:EUTRa:DL[:SUBF<st0>]:ENCC:PDCCh:EXTC:ITEM<ch0>:UEID.....	671
[;SOURce<hw>]:BB:EUTRa:DL[:SUBF<st0>]:ENCC:PDCCh:EXTC:ITEM<ch0>:USER.....	674
[;SOURce<hw>]:BB:EUTRa:DL[:SUBF<st0>]:ENCC:PDCCh:EXTC:RESet.....	670
[;SOURce<hw>]:BB:EUTRa:DL[:SUBF<st0>]:ENCC:PDCCh:EXTC:SITem.....	668
[;SOURce<hw>]:BB:EUTRa:DL[:SUBF<st0>]:ENCC:PDCCh:EXTC:SOLVe?.....	670
[;SOURce<hw>]:BB:EUTRa:DL[:SUBF<st0>]:ENCC:PDCCh:EXTC:UITems.....	670
[;SOURce<hw>]:BB:EUTRa:DL[:SUBF<st0>]:ENCC:PDCCh:EXTC:UP.....	669
[;SOURce<hw>]:BB:EUTRa:DL[:SUBF<st0>]:ENCC:PDCCh:FORMat.....	664
[;SOURce<hw>]:BB:EUTRa:DL[:SUBF<st0>]:ENCC:PDCCh:NOPDcchs.....	664
[;SOURce<hw>]:BB:EUTRa:DL[:SUBF<st0>]:ENCC:PDCCh:PATtern.....	666
[;SOURce<hw>]:BB:EUTRa:DL[:SUBF<st0>]:ENCC:PDCCh:POWer.....	662
[;SOURce<hw>]:BB:EUTRa:DL[:SUBF<st0>]:ENCC:PHICh:CELL<ch0>:ANPattern<gr0>.....	661
[;SOURce<hw>]:BB:EUTRa:DL[:SUBF<st0>]:ENCC:PHICh:PMODE.....	660
[;SOURce<hw>]:BB:EUTRa:DL[:SUBF<st0>]:ENCC:PHICh:POWer.....	661
[;SOURce<hw>]:BB:EUTRa:DL[:SUBF<st0>]:ENCC:PHICh[:CELL<ccidx>]:GROup<gr0>: ITEM<user0>:POW.....	662

[SOURce<hw>]:BB:EUTRa:DL[:SUBF<st0>]:ENCC:PHICH[:CELL<ccid>]:NOGRoups.....	661
[SOURce<hw>]:BB:EUTRa:DL[:SUBF<st0>]:ENCC:PRECoding:NOLayers?.....	659
[SOURce<hw>]:BB:EUTRa:DL[:SUBF<st0>]:ENCC:PRECoding:SCHEME.....	659
[SOURce<hw>]:BB:EUTRa:DL[:SUBF<st0>]:ENCC:SCRambling:STATE.....	658
[SOURce<hw>]:BB:EUTRa:DL[:SUBF<st0>]:ENCC:STATE.....	658
[SOURce<hw>]:BB:EUTRa:DL[:SUBF<st0>]:USER<ch>:PHYSbits?.....	612
[SOURce<hw>]:BB:EUTRa:DUPLexing.....	556
[SOURce<hw>]:BB:EUTRa:FILTer:AUTO?.....	563
[SOURce<hw>]:BB:EUTRa:FILTer:MODE.....	561
[SOURce<hw>]:BB:EUTRa:FILTer:PARAmeter:APCO25.....	562
[SOURce<hw>]:BB:EUTRa:FILTer:PARAmeter:COSSine.....	562
[SOURce<hw>]:BB:EUTRa:FILTer:PARAmeter:COSSine:COFS.....	562
[SOURce<hw>]:BB:EUTRa:FILTer:PARAmeter:GAUSSs.....	562
[SOURce<hw>]:BB:EUTRa:FILTer:PARAmeter:LPASSs.....	562
[SOURce<hw>]:BB:EUTRa:FILTer:PARAmeter:LPASSEVM.....	562
[SOURce<hw>]:BB:EUTRa:FILTer:PARAmeter:LTE:COFFactor.....	563
[SOURce<hw>]:BB:EUTRa:FILTer:PARAmeter:LTE:COFS.....	562
[SOURce<hw>]:BB:EUTRa:FILTer:PARAmeter:LTE:OPTimization.....	563
[SOURce<hw>]:BB:EUTRa:FILTer:PARAmeter:LTE:ROFFactor.....	563
[SOURce<hw>]:BB:EUTRa:FILTer:PARAmeter:PGAuss.....	562
[SOURce<hw>]:BB:EUTRa:FILTer:PARAmeter:RCOSSine.....	562
[SOURce<hw>]:BB:EUTRa:FILTer:PARAmeter:SPHase.....	562
[SOURce<hw>]:BB:EUTRa:FILTer:PARAmeter:USER.....	564
[SOURce<hw>]:BB:EUTRa:FILTer:TYPE.....	561
[SOURce<hw>]:BB:EUTRa:LINK.....	557
[SOURce<hw>]:BB:EUTRa:POWC:LEVReference.....	567
[SOURce<hw>]:BB:EUTRa:POWC:REFChannel.....	567
[SOURce<hw>]:BB:EUTRa:POWC:REFSubframe?.....	568
[SOURce<hw>]:BB:EUTRa:POWC:RUE?.....	568
[SOURce<hw>]:BB:EUTRa:PRESet.....	557
[SOURce<hw>]:BB:EUTRa:SETTing:CATalog.....	558
[SOURce<hw>]:BB:EUTRa:SETTing:DEL.....	558
[SOURce<hw>]:BB:EUTRa:SETTing:LOAD.....	558
[SOURce<hw>]:BB:EUTRa:SETTing:STORe.....	559
[SOURce<hw>]:BB:EUTRa:SETTing:TMOD:DL.....	559
[SOURce<hw>]:BB:EUTRa:SETTing:TMOD:TDD.....	559
[SOURce<hw>]:BB:EUTRa:SLENgth.....	559
[SOURce<hw>]:BB:EUTRa:SRATe:VARiation.....	564
[SOURce<hw>]:BB:EUTRa:STATE.....	556
[SOURce<hw>]:BB:EUTRa:STDMoDe.....	557
[SOURce<hw>]:BB:EUTRa:SUSLen.....	559
[SOURce<hw>]:BB:EUTRa:TCW:APPLysettings.....	933
[SOURce<hw>]:BB:EUTRa:TCW:AWGN:PLEVel?.....	934
[SOURce<hw>]:BB:EUTRa:TCW:FA:FRALlocation.....	934
[SOURce<hw>]:BB:EUTRa:TCW:FA:RBALlocation.....	934
[SOURce<hw>]:BB:EUTRa:TCW:GS:BSCLass.....	935
[SOURce<hw>]:BB:EUTRa:TCW:GS:MARKerconfig.....	935
[SOURce<hw>]:BB:EUTRa:TCW:GS:RELease.....	934
[SOURce<hw>]:BB:EUTRa:TCW:GS:SIGRout.....	935
[SOURce<hw>]:BB:EUTRa:TCW:GS:SPEC.....	934

[SOURce<hw>]:BB:EUTRa:TCW:GS:TRIGgerconfig.....	936
[SOURce<hw>]:BB:EUTRa:TCW:IS:CHBW?.....	936
[SOURce<hw>]:BB:EUTRa:TCW:IS:CLID.....	936
[SOURce<hw>]:BB:EUTRa:TCW:IS:DUPLex.....	936
[SOURce<hw>]:BB:EUTRa:TCW:IS:IFTYpe.....	937
[SOURce<hw>]:BB:EUTRa:TCW:IS:NRBLock?.....	937
[SOURce<hw>]:BB:EUTRa:TCW:IS:NTAOffset.....	937
[SOURce<hw>]:BB:EUTRa:TCW:IS:OCEDge.....	937
[SOURce<hw>]:BB:EUTRa:TCW:IS:OVRB?.....	938
[SOURce<hw>]:BB:EUTRa:TCW:IS:PLEVel?.....	938
[SOURce<hw>]:BB:EUTRa:TCW:IS:RFFRequency.....	938
[SOURce<hw>]:BB:EUTRa:TCW:IS:TDDConfig.....	938
[SOURce<hw>]:BB:EUTRa:TCW:IS:TMODeL?.....	939
[SOURce<hw>]:BB:EUTRa:TCW:IS:UEID.....	939
[SOURce<hw>]:BB:EUTRa:TCW:IS2:CHBW?.....	936
[SOURce<hw>]:BB:EUTRa:TCW:IS2:DUPLex.....	936
[SOURce<hw>]:BB:EUTRa:TCW:IS2:IFTYpe?.....	937
[SOURce<hw>]:BB:EUTRa:TCW:IS2:PLEVel?.....	938
[SOURce<hw>]:BB:EUTRa:TCW:IS2:RFFRequency.....	938
[SOURce<hw>]:BB:EUTRa:TCW:IS3:PLEVel?.....	938
[SOURce<hw>]:BB:EUTRa:TCW:MUE:OVRB.....	941
[SOURce<hw>]:BB:EUTRa:TCW:MUE:UEID.....	942
[SOURce<hw>]:BB:EUTRa:TCW:SUE:OVRB.....	941
[SOURce<hw>]:BB:EUTRa:TCW:SUE:UEID.....	942
[SOURce<hw>]:BB:EUTRa:TCW:TC.....	939
[SOURce<hw>]:BB:EUTRa:TCW:WS:CHBW.....	940
[SOURce<hw>]:BB:EUTRa:TCW:WS:CLID.....	940
[SOURce<hw>]:BB:EUTRa:TCW:WS:CYCPrefix.....	940
[SOURce<hw>]:BB:EUTRa:TCW:WS:DUPLex.....	940
[SOURce<hw>]:BB:EUTRa:TCW:WS:FRC.....	940
[SOURce<hw>]:BB:EUTRa:TCW:WS:NTAOffset.....	941
[SOURce<hw>]:BB:EUTRa:TCW:WS:OUPLevel.....	941
[SOURce<hw>]:BB:EUTRa:TCW:WS:OVRB.....	941
[SOURce<hw>]:BB:EUTRa:TCW:WS:PLEVel?.....	941
[SOURce<hw>]:BB:EUTRa:TCW:WS:RFFRequency.....	942
[SOURce<hw>]:BB:EUTRa:TCW:WS:TDDConfig.....	942
[SOURce<hw>]:BB:EUTRa:TCW:WS:UEID.....	942
[SOURce<hw>]:BB:EUTRa:TDD:SPSCConf.....	578
[SOURce<hw>]:BB:EUTRa:TDD:UDConf.....	579
[SOURce<hw>]:BB:EUTRa:TDD:UPTS.....	579
[SOURce<hw>]:BB:EUTRa:TDW:STATe.....	566
[SOURce<hw>]:BB:EUTRa:TDW:TRTime.....	566
[SOURce<hw>]:BB:EUTRa:TIMC:NTAoffset.....	569
[SOURce<hw>]:BB:EUTRa:TRIGger:ARM:EXECute.....	571
[SOURce<hw>]:BB:EUTRa:TRIGger:DELay:UNIT.....	571
[SOURce<hw>]:BB:EUTRa:TRIGger:EXECute.....	571
[SOURce<hw>]:BB:EUTRa:TRIGger:EXTernal:RDELay?.....	575
[SOURce<hw>]:BB:EUTRa:TRIGger:EXTernal:SYNChronize:OUTPut.....	572
[SOURce<hw>]:BB:EUTRa:TRIGger:EXTernal:TDELay.....	575
[SOURce<hw>]:BB:EUTRa:TRIGger:OUTPut<ch>:DELay.....	577

[SOURce<hw>]:BB:EUTRa:TRIGger:OUTPut<ch>:DINSec?	578
[SOURce<hw>]:BB:EUTRa:TRIGger:OUTPut<ch>:FOFFset	577
[SOURce<hw>]:BB:EUTRa:TRIGger:OUTPut<ch>:MODE	576
[SOURce<hw>]:BB:EUTRa:TRIGger:OUTPut<ch>:OFFTime	577
[SOURce<hw>]:BB:EUTRa:TRIGger:OUTPut<ch>:ONTime	577
[SOURce<hw>]:BB:EUTRa:TRIGger:OUTPut<ch>:PERiod	577
[SOURce<hw>]:BB:EUTRa:TRIGger:OUTPut<ch>:ROFFset	577
[SOURce<hw>]:BB:EUTRa:TRIGger:RMODE?	572
[SOURce<hw>]:BB:EUTRa:TRIGger:SLENgth	572
[SOURce<hw>]:BB:EUTRa:TRIGger:SLUNit	572
[SOURce<hw>]:BB:EUTRa:TRIGger:SOURce	571
[SOURce<hw>]:BB:EUTRa:TRIGger:TIME:DATE	573
[SOURce<hw>]:BB:EUTRa:TRIGger:TIME:TIME	573
[SOURce<hw>]:BB:EUTRa:TRIGger:TIME[:STATE]	574
[SOURce<hw>]:BB:EUTRa:TRIGger[:EXTeRnal]:DELay	574
[SOURce<hw>]:BB:EUTRa:TRIGger[:EXTeRnal]:INHibit	574
[SOURce<hw>]:BB:EUTRa:UL:BW	593
[SOURce<hw>]:BB:EUTRa:UL:CA:CELL<ch0>:BW	708
[SOURce<hw>]:BB:EUTRa:UL:CA:CELL<ch0>:CSRS	709
[SOURce<hw>]:BB:EUTRa:UL:CA:CELL<ch0>:DFReq	708
[SOURce<hw>]:BB:EUTRa:UL:CA:CELL<ch0>:DMRS	709
[SOURce<hw>]:BB:EUTRa:UL:CA:CELL<ch0>:DUPLexing	708
[SOURce<hw>]:BB:EUTRa:UL:CA:CELL<ch0>:ID	707
[SOURce<hw>]:BB:EUTRa:UL:CA:CELL<ch0>:INDex	707
[SOURce<hw>]:BB:EUTRa:UL:CA:CELL<ch0>:SPSConf	709
[SOURce<hw>]:BB:EUTRa:UL:CA:CELL<ch0>:STATe	710
[SOURce<hw>]:BB:EUTRa:UL:CA:CELL<ch0>:SUConfiguration	709
[SOURce<hw>]:BB:EUTRa:UL:CA:CELL<ch0>:TDELay	710
[SOURce<hw>]:BB:EUTRa:UL:CA:CELL<ch0>:UDConf	708
[SOURce<hw>]:BB:EUTRa:UL:CA:STATe	707
[SOURce<hw>]:BB:EUTRa:UL:CPC	596
[SOURce<hw>]:BB:EUTRa:UL:DLCPc	596
[SOURce<hw>]:BB:EUTRa:UL:EMTC:NNBands?	893
[SOURce<hw>]:BB:EUTRa:UL:EMTC:NWBands?	894
[SOURce<hw>]:BB:EUTRa:UL:EMTC:RSYMBOL	894
[SOURce<hw>]:BB:EUTRa:UL:EMTC:VALid:SUBFrame<dir>	895
[SOURce<hw>]:BB:EUTRa:UL:EMTC:WBCFg	894
[SOURce<hw>]:BB:EUTRa:UL:FFT	594
[SOURce<hw>]:BB:EUTRa:UL:LGS?	594
[SOURce<hw>]:BB:EUTRa:UL:NIOT:SUBConfig	894
[SOURce<hw>]:BB:EUTRa:UL:NIOT:VALid:SUBFrame<dir>	895
[SOURce<hw>]:BB:EUTRa:UL:NORB	593
[SOURce<hw>]:BB:EUTRa:UL:OCCBandwidth?	594
[SOURce<hw>]:BB:EUTRa:UL:OCCSubcarriers?	594
[SOURce<hw>]:BB:EUTRa:UL:PRACH:CONFIguration	600
[SOURce<hw>]:BB:EUTRa:UL:PRACH:EMTC:CELV<ch0>:CONFIg	900
[SOURce<hw>]:BB:EUTRa:UL:PRACH:EMTC:CELV<ch0>:FOFFset	900
[SOURce<hw>]:BB:EUTRa:UL:PRACH:EMTC:CELV<ch0>:HOPPing	900
[SOURce<hw>]:BB:EUTRa:UL:PRACH:EMTC:CELV<ch0>:REPetit	900
[SOURce<hw>]:BB:EUTRa:UL:PRACH:EMTC:CELV<ch0>:SSFPeriod	901

[SOURce<hw>]:BB:EUTRa:UL:PRACH:EMTC:HOFF.....	899
[SOURce<hw>]:BB:EUTRa:UL:PRACH:EMTC:RSET.....	899
[SOURce<hw>]:BB:EUTRa:UL:PRACH:FOFFset.....	600
[SOURce<hw>]:BB:EUTRa:UL:PRACH:NIOT:CFG<ch0>:PERD.....	898
[SOURce<hw>]:BB:EUTRa:UL:PRACH:NIOT:CFG<ch0>:REP.....	898
[SOURce<hw>]:BB:EUTRa:UL:PRACH:NIOT:CFG<ch0>:SCOF.....	899
[SOURce<hw>]:BB:EUTRa:UL:PRACH:NIOT:CFG<ch0>:STTM.....	898
[SOURce<hw>]:BB:EUTRa:UL:PRACH:NIOT:CFG<ch0>:SUBC.....	898
[SOURce<hw>]:BB:EUTRa:UL:PRACH:NIOT:PFMT.....	897
[SOURce<hw>]:BB:EUTRa:UL:PRACH:RSET.....	600
[SOURce<hw>]:BB:EUTRa:UL:PUCCh:DESHift.....	602
[SOURce<hw>]:BB:EUTRa:UL:PUCCh:N1CS.....	602
[SOURce<hw>]:BB:EUTRa:UL:PUCCh:N1EMax?.....	603
[SOURce<hw>]:BB:EUTRa:UL:PUCCh:N1NMax?.....	603
[SOURce<hw>]:BB:EUTRa:UL:PUCCh:N2Max?.....	603
[SOURce<hw>]:BB:EUTRa:UL:PUCCh:N2RB.....	602
[SOURce<hw>]:BB:EUTRa:UL:PUCCh:N3Max?.....	604
[SOURce<hw>]:BB:EUTRa:UL:PUCCh:N4Max?.....	604
[SOURce<hw>]:BB:EUTRa:UL:PUCCh:N5Max?.....	604
[SOURce<hw>]:BB:EUTRa:UL:PUCCh:NORB.....	601
[SOURce<hw>]:BB:EUTRa:UL:PUSCh:FHMode.....	600
[SOURce<hw>]:BB:EUTRa:UL:PUSCh:FHOFFset.....	601
[SOURce<hw>]:BB:EUTRa:UL:PUSCh:NHOFFset.....	895
[SOURce<hw>]:BB:EUTRa:UL:PUSCh:NHOPping.....	895
[SOURce<hw>]:BB:EUTRa:UL:PUSCh:NOSM.....	601
[SOURce<hw>]:BB:EUTRa:UL:REFSig:DMRS.....	598
[SOURce<hw>]:BB:EUTRa:UL:REFSig:DRS:DSEQshift.....	896
[SOURce<hw>]:BB:EUTRa:UL:REFSig:DRS:GHOPping.....	895
[SOURce<hw>]:BB:EUTRa:UL:REFSig:DRS:STBSequence.....	897
[SOURce<hw>]:BB:EUTRa:UL:REFSig:DRS:STCShift.....	896
[SOURce<hw>]:BB:EUTRa:UL:REFSig:DRS:TTBSequence.....	897
[SOURce<hw>]:BB:EUTRa:UL:REFSig:DRS:TTCShift.....	896
[SOURce<hw>]:BB:EUTRa:UL:REFSig:DRS:TWBSequence.....	897
[SOURce<hw>]:BB:EUTRa:UL:REFSig:DRS:USEBase.....	896
[SOURce<hw>]:BB:EUTRa:UL:REFSig:DSSHift.....	597
[SOURce<hw>]:BB:EUTRa:UL:REFSig:GRPHopping.....	597
[SOURce<hw>]:BB:EUTRa:UL:REFSig:SEQHopping.....	597
[SOURce<hw>]:BB:EUTRa:UL:REFSig:SRS:ANSTx.....	598
[SOURce<hw>]:BB:EUTRa:UL:REFSig:SRS:CSRS.....	598
[SOURce<hw>]:BB:EUTRa:UL:REFSig:SRS:DSFC?.....	599
[SOURce<hw>]:BB:EUTRa:UL:REFSig:SRS:MUPTs.....	598
[SOURce<hw>]:BB:EUTRa:UL:REFSig:SRS:SUConfiguration.....	599
[SOURce<hw>]:BB:EUTRa:UL:REFSig:SRS:TSFC?.....	599
[SOURce<hw>]:BB:EUTRa:UL:RGS?.....	595
[SOURce<hw>]:BB:EUTRa:UL:RSTFrame.....	703
[SOURce<hw>]:BB:EUTRa:UL:SOFFset.....	596
[SOURce<hw>]:BB:EUTRa:UL:SRAtE?.....	593
[SOURce<hw>]:BB:EUTRa:UL:UE<st>:APMap:AP10Map:ROW<bbid>.....	769
[SOURce<hw>]:BB:EUTRa:UL:UE<st>:APMap:AP20Map:ROW<bbid>.....	769
[SOURce<hw>]:BB:EUTRa:UL:UE<st>:APMap:AP21Map:ROW<bbid>.....	769

[SOURce<hw>]:BB:EUTRa:UL:UE<st>:APMap:AP40Map:ROW<bbid>.....	769
[SOURce<hw>]:BB:EUTRa:UL:UE<st>:APMap:AP41Map:ROW<bbid>.....	769
[SOURce<hw>]:BB:EUTRa:UL:UE<st>:APMap:AP42Map:ROW<bbid>.....	769
[SOURce<hw>]:BB:EUTRa:UL:UE<st>:APMap:AP43Map:ROW<bbid>.....	769
[SOURce<hw>]:BB:EUTRa:UL:UE<st>:APMap:AP100Map:ROW<bbid>.....	769
[SOURce<hw>]:BB:EUTRa:UL:UE<st>:APMap:AP200Map:ROW<bbid>.....	769
[SOURce<hw>]:BB:EUTRa:UL:UE<st>:APMap:AP201Map:ROW<bbid>.....	769
[SOURce<hw>]:BB:EUTRa:UL:UE<st>:APMap:AP1000Map:ROW<bbid>.....	769
[SOURce<hw>]:BB:EUTRa:UL:UE<st>:APMap:AP1010Map:ROW<bbid>.....	769
[SOURce<hw>]:BB:EUTRa:UL:UE<st>:APMap:AP1020Map:ROW<bbid>.....	769
[SOURce<hw>]:BB:EUTRa:UL:UE<st>:CELL<dir0>:POFFset.....	770
[SOURce<hw>]:BB:EUTRa:UL:UE<st>:CID.....	749
[SOURce<hw>]:BB:EUTRa:UL:UE<st>:CONSubframes:PUCCh.....	702
[SOURce<hw>]:BB:EUTRa:UL:UE<st>:CONSubframes:PUSCh.....	702
[SOURce<hw>]:BB:EUTRa:UL:UE<st>:DACRestart.....	747
[SOURce<hw>]:BB:EUTRa:UL:UE<st>:EMTC:ARB:SUGGested?.....	924
[SOURce<hw>]:BB:EUTRa:UL:UE<st>:EMTC:CELevel.....	920
[SOURce<hw>]:BB:EUTRa:UL:UE<st>:EMTC:HOPP.....	920
[SOURce<hw>]:BB:EUTRa:UL:UE<st>:EMTC:NTRansmiss.....	920
[SOURce<hw>]:BB:EUTRa:UL:UE<st>:EMTC:TRANS<ch>:ASFRframe?.....	921
[SOURce<hw>]:BB:EUTRa:UL:UE<st>:EMTC:TRANS<ch>:CCODing:RVINdex.....	928
[SOURce<hw>]:BB:EUTRa:UL:UE<st>:EMTC:TRANS<ch>:CCODing:TBSize.....	926
[SOURce<hw>]:BB:EUTRa:UL:UE<st>:EMTC:TRANS<ch>:CONTenT.....	920
[SOURce<hw>]:BB:EUTRa:UL:UE<st>:EMTC:TRANS<ch>:DRS:CYCShift?.....	924
[SOURce<hw>]:BB:EUTRa:UL:UE<st>:EMTC:TRANS<ch>:FORMat.....	921
[SOURce<hw>]:BB:EUTRa:UL:UE<st>:EMTC:TRANS<ch>:HARQ:BITS.....	927
[SOURce<hw>]:BB:EUTRa:UL:UE<st>:EMTC:TRANS<ch>:HARQ:CBITS?.....	927
[SOURce<hw>]:BB:EUTRa:UL:UE<st>:EMTC:TRANS<ch>:HARQ:MODE.....	926
[SOURce<hw>]:BB:EUTRa:UL:UE<st>:EMTC:TRANS<ch>:HARQ:PATtern.....	927
[SOURce<hw>]:BB:EUTRa:UL:UE<st>:EMTC:TRANS<ch>:MODulation.....	921
[SOURce<hw>]:BB:EUTRa:UL:UE<st>:EMTC:TRANS<ch>:NAPused?.....	926
[SOURce<hw>]:BB:EUTRa:UL:UE<st>:EMTC:TRANS<ch>:NDMRs?.....	924
[SOURce<hw>]:BB:EUTRa:UL:UE<st>:EMTC:TRANS<ch>:NPUCch.....	927
[SOURce<hw>]:BB:EUTRa:UL:UE<st>:EMTC:TRANS<ch>:NRBLocks.....	922
[SOURce<hw>]:BB:EUTRa:UL:UE<st>:EMTC:TRANS<ch>:PHYSbits?.....	928
[SOURce<hw>]:BB:EUTRa:UL:UE<st>:EMTC:TRANS<ch>:POWer.....	924
[SOURce<hw>]:BB:EUTRa:UL:UE<st>:EMTC:TRANS<ch>:PUCCh:CQI:BITS.....	929
[SOURce<hw>]:BB:EUTRa:UL:UE<st>:EMTC:TRANS<ch>:PUCCh:CQI:CBITS?.....	929
[SOURce<hw>]:BB:EUTRa:UL:UE<st>:EMTC:TRANS<ch>:PUCCh:CQI:PATtern.....	929
[SOURce<hw>]:BB:EUTRa:UL:UE<st>:EMTC:TRANS<ch>:PUCCh:HARQ:PATtern.....	928
[SOURce<hw>]:BB:EUTRa:UL:UE<st>:EMTC:TRANS<ch>:PUSCh:CQI:BITS.....	925
[SOURce<hw>]:BB:EUTRa:UL:UE<st>:EMTC:TRANS<ch>:PUSCh:CQI:CBITS?.....	925
[SOURce<hw>]:BB:EUTRa:UL:UE<st>:EMTC:TRANS<ch>:PUSCh:CQI:PATtern.....	925
[SOURce<hw>]:BB:EUTRa:UL:UE<st>:EMTC:TRANS<ch>:RBOFFset.....	922
[SOURce<hw>]:BB:EUTRa:UL:UE<st>:EMTC:TRANS<ch>:REPetitions.....	922
[SOURce<hw>]:BB:EUTRa:UL:UE<st>:EMTC:TRANS<ch>:STNBand.....	922
[SOURce<hw>]:BB:EUTRa:UL:UE<st>:EMTC:TRANS<ch>:STSFrame.....	921
[SOURce<hw>]:BB:EUTRa:UL:UE<st>:EMTC:TRANS<ch>:STWBand.....	923
[SOURce<hw>]:BB:EUTRa:UL:UE<st>:EMTC:TRANS<ch>:ULSch:BITS?.....	926
[SOURce<hw>]:BB:EUTRa:UL:UE<st>:EMTC:TRANS<ch>:WBRBOffset.....	923

[SOURce<hw>]:BB:EUTRa:UL:UE<st>:EMTC:TRANs<ch>:WRBLocks.....	923
[SOURce<hw>]:BB:EUTRa:UL:UE<st>:ID.....	748
[SOURce<hw>]:BB:EUTRa:UL:UE<st>:MODE.....	748
[SOURce<hw>]:BB:EUTRa:UL:UE<st>:NIOT:ARB:SUGGested?.....	907
[SOURce<hw>]:BB:EUTRa:UL:UE<st>:NIOT:DFReq.....	904
[SOURce<hw>]:BB:EUTRa:UL:UE<st>:NIOT:FRC:ALResunits?.....	912
[SOURce<hw>]:BB:EUTRa:UL:UE<st>:NIOT:FRC:ALResunits?.....	917
[SOURce<hw>]:BB:EUTRa:UL:UE<st>:NIOT:FRC:BPResunit?.....	912
[SOURce<hw>]:BB:EUTRa:UL:UE<st>:NIOT:FRC:BPResunit?.....	919
[SOURce<hw>]:BB:EUTRa:UL:UE<st>:NIOT:FRC:MODulation?.....	913
[SOURce<hw>]:BB:EUTRa:UL:UE<st>:NIOT:FRC:MODulation?.....	918
[SOURce<hw>]:BB:EUTRa:UL:UE<st>:NIOT:FRC:NNPRep.....	913
[SOURce<hw>]:BB:EUTRa:UL:UE<st>:NIOT:FRC:NNPRep.....	919
[SOURce<hw>]:BB:EUTRa:UL:UE<st>:NIOT:FRC:NOSCarriers?.....	913
[SOURce<hw>]:BB:EUTRa:UL:UE<st>:NIOT:FRC:NOSCarriers?.....	919
[SOURce<hw>]:BB:EUTRa:UL:UE<st>:NIOT:FRC:PASize?.....	913
[SOURce<hw>]:BB:EUTRa:UL:UE<st>:NIOT:FRC:PASize?.....	918
[SOURce<hw>]:BB:EUTRa:UL:UE<st>:NIOT:FRC:PASize?.....	919
[SOURce<hw>]:BB:EUTRa:UL:UE<st>:NIOT:FRC:SCSPacing?.....	914
[SOURce<hw>]:BB:EUTRa:UL:UE<st>:NIOT:FRC:SCSPacing?.....	918
[SOURce<hw>]:BB:EUTRa:UL:UE<st>:NIOT:FRC:STATE.....	912
[SOURce<hw>]:BB:EUTRa:UL:UE<st>:NIOT:FRC:STATE.....	917
[SOURce<hw>]:BB:EUTRa:UL:UE<st>:NIOT:FRC:TBSSindex?.....	914
[SOURce<hw>]:BB:EUTRa:UL:UE<st>:NIOT:FRC:TBSSindex?.....	918
[SOURce<hw>]:BB:EUTRa:UL:UE<st>:NIOT:FRC:TYPE.....	912
[SOURce<hw>]:BB:EUTRa:UL:UE<st>:NIOT:FRC:TYPE.....	917
[SOURce<hw>]:BB:EUTRa:UL:UE<st>:NIOT:GHDisable.....	903
[SOURce<hw>]:BB:EUTRa:UL:UE<st>:NIOT:MODE.....	904
[SOURce<hw>]:BB:EUTRa:UL:UE<st>:NIOT:NPSSim.....	908
[SOURce<hw>]:BB:EUTRa:UL:UE<st>:NIOT:NTRansmiss.....	904
[SOURce<hw>]:BB:EUTRa:UL:UE<st>:NIOT:RBIndex.....	903
[SOURce<hw>]:BB:EUTRa:UL:UE<st>:NIOT:SCSPacing.....	903
[SOURce<hw>]:BB:EUTRa:UL:UE<st>:NIOT:TRANs<ch>:FORMat.....	904
[SOURce<hw>]:BB:EUTRa:UL:UE<st>:NIOT:TRANs<ch>:HARQ:BITS?.....	908
[SOURce<hw>]:BB:EUTRa:UL:UE<st>:NIOT:TRANs<ch>:HARQ:CBITs?.....	908
[SOURce<hw>]:BB:EUTRa:UL:UE<st>:NIOT:TRANs<ch>:HARQ:PATtern.....	909
[SOURce<hw>]:BB:EUTRa:UL:UE<st>:NIOT:TRANs<ch>:HARQ:SR.....	909
[SOURce<hw>]:BB:EUTRa:UL:UE<st>:NIOT:TRANs<ch>:MODulation.....	905
[SOURce<hw>]:BB:EUTRa:UL:UE<st>:NIOT:TRANs<ch>:NRUNits.....	905
[SOURce<hw>]:BB:EUTRa:UL:UE<st>:NIOT:TRANs<ch>:NSCarriers?.....	906
[SOURce<hw>]:BB:EUTRa:UL:UE<st>:NIOT:TRANs<ch>:NSLTs?.....	906
[SOURce<hw>]:BB:EUTRa:UL:UE<st>:NIOT:TRANs<ch>:POWer.....	907
[SOURce<hw>]:BB:EUTRa:UL:UE<st>:NIOT:TRANs<ch>:PUSCh:ESUPport.....	909
[SOURce<hw>]:BB:EUTRa:UL:UE<st>:NIOT:TRANs<ch>:PUSCh:ETBS.....	909
[SOURce<hw>]:BB:EUTRa:UL:UE<st>:NIOT:TRANs<ch>:PUSCh:ETRSize.....	910
[SOURce<hw>]:BB:EUTRa:UL:UE<st>:NIOT:TRANs<ch>:PUSCh:PHYSbits?.....	910
[SOURce<hw>]:BB:EUTRa:UL:UE<st>:NIOT:TRANs<ch>:PUSCh:RUIndex?.....	910
[SOURce<hw>]:BB:EUTRa:UL:UE<st>:NIOT:TRANs<ch>:PUSCh:RVIndex.....	911
[SOURce<hw>]:BB:EUTRa:UL:UE<st>:NIOT:TRANs<ch>:PUSCh:TBIndex.....	911
[SOURce<hw>]:BB:EUTRa:UL:UE<st>:NIOT:TRANs<ch>:PUSCh:TBSsize?.....	911

[SOURce<hw>]:BB:EUTRa:UL:UE<st>:NIOT:TRANs<ch>:REPetitions.....	905
[SOURce<hw>]:BB:EUTRa:UL:UE<st>:NIOT:TRANs<ch>:SIRF.....	906
[SOURce<hw>]:BB:EUTRa:UL:UE<st>:NIOT:TRANs<ch>:STSCarrier?.....	907
[SOURce<hw>]:BB:EUTRa:UL:UE<st>:NIOT:TRANs<ch>:STSFrame.....	905
[SOURce<hw>]:BB:EUTRa:UL:UE<st>:NIOT:TRANs<ch>:STSLot?.....	907
[SOURce<hw>]:BB:EUTRa:UL:UE<st>:OCID:STATe.....	749
[SOURce<hw>]:BB:EUTRa:UL:UE<st>:POWer.....	748
[SOURce<hw>]:BB:EUTRa:UL:UE<st>:PRACH:ATT<ch0>:EMTC:CELV.....	930
[SOURce<hw>]:BB:EUTRa:UL:UE<st>:PRACH:ATT<ch0>:EMTC:DT.....	931
[SOURce<hw>]:BB:EUTRa:UL:UE<st>:PRACH:ATT<ch0>:EMTC:FRINdex.....	930
[SOURce<hw>]:BB:EUTRa:UL:UE<st>:PRACH:ATT<ch0>:EMTC:NCSConf.....	931
[SOURce<hw>]:BB:EUTRa:UL:UE<st>:PRACH:ATT<ch0>:EMTC:POWer.....	932
[SOURce<hw>]:BB:EUTRa:UL:UE<st>:PRACH:ATT<ch0>:EMTC:RSEQuence.....	931
[SOURce<hw>]:BB:EUTRa:UL:UE<st>:PRACH:ATT<ch0>:EMTC:SFSTart.....	930
[SOURce<hw>]:BB:EUTRa:UL:UE<st>:PRACH:ATT<ch0>:EMTC:SINDeX.....	931
[SOURce<hw>]:BB:EUTRa:UL:UE<st>:PRACH:ATT<ch0>:NIOT:CONFIg.....	915
[SOURce<hw>]:BB:EUTRa:UL:UE<st>:PRACH:ATT<ch0>:NIOT:INIT.....	916
[SOURce<hw>]:BB:EUTRa:UL:UE<st>:PRACH:ATT<ch0>:NIOT:POWer.....	916
[SOURce<hw>]:BB:EUTRa:UL:UE<st>:PRACH:ATT<ch0>:NIOT:SFSTart.....	915
[SOURce<hw>]:BB:EUTRa:UL:UE<st>:PRACH:ATT<ch0>:NIOT:STRT?.....	916
[SOURce<hw>]:BB:EUTRa:UL:UE<st>:PRACH:CFRames?.....	753
[SOURce<hw>]:BB:EUTRa:UL:UE<st>:PRACH:EMTC:ARB:SUGGested?.....	932
[SOURce<hw>]:BB:EUTRa:UL:UE<st>:PRACH:EMTC:PRATtempts.....	930
[SOURce<hw>]:BB:EUTRa:UL:UE<st>:PRACH:NIOT:ARB:SUGGested?.....	916
[SOURce<hw>]:BB:EUTRa:UL:UE<st>:PRACH:NIOT:DFReq.....	915
[SOURce<hw>]:BB:EUTRa:UL:UE<st>:PRACH:NIOT:MOD.....	914
[SOURce<hw>]:BB:EUTRa:UL:UE<st>:PRACH:NIOT:PRATtempts.....	914
[SOURce<hw>]:BB:EUTRa:UL:UE<st>:PRACH:NIOT:RBID.....	915
[SOURce<hw>]:BB:EUTRa:UL:UE<st>:PRACH:PRFormat?.....	753
[SOURce<hw>]:BB:EUTRa:UL:UE<st>:PRACH:PRState.....	752
[SOURce<hw>]:BB:EUTRa:UL:UE<st>:PRACH:PRTT.....	753
[SOURce<hw>]:BB:EUTRa:UL:UE<st>:PRACH:SUBF<ch0>:DT.....	755
[SOURce<hw>]:BB:EUTRa:UL:UE<st>:PRACH:SUBF<ch0>:FRINdex.....	754
[SOURce<hw>]:BB:EUTRa:UL:UE<st>:PRACH:SUBF<ch0>:NCSConf.....	754
[SOURce<hw>]:BB:EUTRa:UL:UE<st>:PRACH:SUBF<ch0>:POWer.....	754
[SOURce<hw>]:BB:EUTRa:UL:UE<st>:PRACH:SUBF<ch0>:RBOFfset.....	754
[SOURce<hw>]:BB:EUTRa:UL:UE<st>:PRACH:SUBF<ch0>:RSEQuence.....	755
[SOURce<hw>]:BB:EUTRa:UL:UE<st>:PRACH:SUBF<ch0>:SINDeX.....	755
[SOURce<hw>]:BB:EUTRa:UL:UE<st>:PRACH:SUBF<ch0>:STATe.....	756
[SOURce<hw>]:BB:EUTRa:UL:UE<st>:PUCCh:F1Naport.....	762
[SOURce<hw>]:BB:EUTRa:UL:UE<st>:PUCCh:F2Naport.....	762
[SOURce<hw>]:BB:EUTRa:UL:UE<st>:PUCCh:F3Naport.....	762
[SOURce<hw>]:BB:EUTRa:UL:UE<st>:PUCCh:F4Naport?.....	761
[SOURce<hw>]:BB:EUTRa:UL:UE<st>:PUCCh:F5Naport?.....	761
[SOURce<hw>]:BB:EUTRa:UL:UE<st>:RELease.....	747
[SOURce<hw>]:BB:EUTRa:UL:UE<st>:SL:ALLoc<ch0>:CCODing:STATe.....	796
[SOURce<hw>]:BB:EUTRa:UL:UE<st>:SL:ALLoc<ch0>:CCODing:TBSI?.....	796
[SOURce<hw>]:BB:EUTRa:UL:UE<st>:SL:ALLoc<ch0>:CCODing:TBSiZe?.....	797
[SOURce<hw>]:BB:EUTRa:UL:UE<st>:SL:ALLoc<ch0>:CONFIct?.....	795
[SOURce<hw>]:BB:EUTRa:UL:UE<st>:SL:ALLoc<ch0>:CONTeNt?.....	793

[SOURce<hw>]:BB:EUTRa:UL:UE<st>:SL:ALLoc<ch0>:CYCShift.....	796
[SOURce<hw>]:BB:EUTRa:UL:UE<st>:SL:ALLoc<ch0>:DISCtype.....	793
[SOURce<hw>]:BB:EUTRa:UL:UE<st>:SL:ALLoc<ch0>:MODulation?.....	794
[SOURce<hw>]:BB:EUTRa:UL:UE<st>:SL:ALLoc<ch0>:NPDSch.....	794
[SOURce<hw>]:BB:EUTRa:UL:UE<st>:SL:ALLoc<ch0>:PHYSbits?.....	794
[SOURce<hw>]:BB:EUTRa:UL:UE<st>:SL:ALLoc<ch0>:POWer.....	795
[SOURce<hw>]:BB:EUTRa:UL:UE<st>:SL:ALLoc<ch0>:PSDPeriod.....	793
[SOURce<hw>]:BB:EUTRa:UL:UE<st>:SL:ALLoc<ch0>:SCRambling:STATe.....	796
[SOURce<hw>]:BB:EUTRa:UL:UE<st>:SL:ALLoc<ch0>:SF?.....	794
[SOURce<hw>]:BB:EUTRa:UL:UE<st>:SL:ALLoc<ch0>:STATe.....	795
[SOURce<hw>]:BB:EUTRa:UL:UE<st>:SL:DATA.....	778
[SOURce<hw>]:BB:EUTRa:UL:UE<st>:SL:DSElect.....	778
[SOURce<hw>]:BB:EUTRa:UL:UE<st>:SL:MODE.....	777
[SOURce<hw>]:BB:EUTRa:UL:UE<st>:SL:NALLoc.....	792
[SOURce<hw>]:BB:EUTRa:UL:UE<st>:SL:NSCI.....	787
[SOURce<hw>]:BB:EUTRa:UL:UE<st>:SL:PATtern.....	778
[SOURce<hw>]:BB:EUTRa:UL:UE<st>:SL:RCTRI:CPERiod.....	779
[SOURce<hw>]:BB:EUTRa:UL:UE<st>:SL:RCTRI:OFFSetind.....	779
[SOURce<hw>]:BB:EUTRa:UL:UE<st>:SL:RCTRI:PRBNumber.....	780
[SOURce<hw>]:BB:EUTRa:UL:UE<st>:SL:RCTRI:PRBStart.....	780
[SOURce<hw>]:BB:EUTRa:UL:UE<st>:SL:RCTRI:PRENd.....	780
[SOURce<hw>]:BB:EUTRa:UL:UE<st>:SL:RCTRI:SFBMp.....	780
[SOURce<hw>]:BB:EUTRa:UL:UE<st>:SL:RDATa:HOPPpingparam.....	785
[SOURce<hw>]:BB:EUTRa:UL:UE<st>:SL:RDATa:NSUBbands.....	785
[SOURce<hw>]:BB:EUTRa:UL:UE<st>:SL:RDATa:OFFSetind.....	779
[SOURce<hw>]:BB:EUTRa:UL:UE<st>:SL:RDATa:PRBNumber.....	780
[SOURce<hw>]:BB:EUTRa:UL:UE<st>:SL:RDATa:PRBStart.....	780
[SOURce<hw>]:BB:EUTRa:UL:UE<st>:SL:RDATa:PRENd.....	780
[SOURce<hw>]:BB:EUTRa:UL:UE<st>:SL:RDATa:RBOffset.....	786
[SOURce<hw>]:BB:EUTRa:UL:UE<st>:SL:RDATa:SFBMp.....	780
[SOURce<hw>]:BB:EUTRa:UL:UE<st>:SL:RDATa:TRPTsubset.....	785
[SOURce<hw>]:BB:EUTRa:UL:UE<st>:SL:RDISc:CPERiod.....	779
[SOURce<hw>]:BB:EUTRa:UL:UE<st>:SL:RDISc:N1PDsch.....	781
[SOURce<hw>]:BB:EUTRa:UL:UE<st>:SL:RDISc:N2PDsch.....	782
[SOURce<hw>]:BB:EUTRa:UL:UE<st>:SL:RDISc:N3PDsch.....	782
[SOURce<hw>]:BB:EUTRa:UL:UE<st>:SL:RDISc:NREPetitions.....	781
[SOURce<hw>]:BB:EUTRa:UL:UE<st>:SL:RDISc:NRETrans.....	781
[SOURce<hw>]:BB:EUTRa:UL:UE<st>:SL:RDISc:OFFSetind.....	779
[SOURce<hw>]:BB:EUTRa:UL:UE<st>:SL:RDISc:PRBNumber.....	780
[SOURce<hw>]:BB:EUTRa:UL:UE<st>:SL:RDISc:PRBStart.....	780
[SOURce<hw>]:BB:EUTRa:UL:UE<st>:SL:RDISc:PRENd.....	780
[SOURce<hw>]:BB:EUTRa:UL:UE<st>:SL:RDISc:PRINdex.....	785
[SOURce<hw>]:BB:EUTRa:UL:UE<st>:SL:RDISc:SFBMp.....	780
[SOURce<hw>]:BB:EUTRa:UL:UE<st>:SL:RDISc:SFINdex.....	784
[SOURce<hw>]:BB:EUTRa:UL:UE<st>:SL:REStart.....	778
[SOURce<hw>]:BB:EUTRa:UL:UE<st>:SL:RMC:ARBLocks?.....	798
[SOURce<hw>]:BB:EUTRa:UL:UE<st>:SL:RMC:MODulation?.....	798
[SOURce<hw>]:BB:EUTRa:UL:UE<st>:SL:RMC:PAYSize?.....	798
[SOURce<hw>]:BB:EUTRa:UL:UE<st>:SL:RMC:PHYSbits?.....	798
[SOURce<hw>]:BB:EUTRa:UL:UE<st>:SL:RMC:RMC.....	797

[SOURce<hw>]:BB:EUTRa:UL:UE<st>:SL:RMC:STATe.....	797
[SOURce<hw>]:BB:EUTRa:UL:UE<st>:SL:SCI<ch0>:BITData?.....	789
[SOURce<hw>]:BB:EUTRa:UL:UE<st>:SL:SCI<ch0>:FHFLag.....	790
[SOURce<hw>]:BB:EUTRa:UL:UE<st>:SL:SCI<ch0>:FORMat.....	788
[SOURce<hw>]:BB:EUTRa:UL:UE<st>:SL:SCI<ch0>:FREQresloc.....	791
[SOURce<hw>]:BB:EUTRa:UL:UE<st>:SL:SCI<ch0>:GRID.....	791
[SOURce<hw>]:BB:EUTRa:UL:UE<st>:SL:SCI<ch0>:MCS.....	790
[SOURce<hw>]:BB:EUTRa:UL:UE<st>:SL:SCI<ch0>:NPSCch.....	788
[SOURce<hw>]:BB:EUTRa:UL:UE<st>:SL:SCI<ch0>:PRIRity.....	791
[SOURce<hw>]:BB:EUTRa:UL:UE<st>:SL:SCI<ch0>:PSCPeriod.....	788
[SOURce<hw>]:BB:EUTRa:UL:UE<st>:SL:SCI<ch0>:RBAHoppalloc.....	790
[SOURce<hw>]:BB:EUTRa:UL:UE<st>:SL:SCI<ch0>:RREServation.....	792
[SOURce<hw>]:BB:EUTRa:UL:UE<st>:SL:SCI<ch0>:SF?.....	788
[SOURce<hw>]:BB:EUTRa:UL:UE<st>:SL:SCI<ch0>:STARTsf.....	789
[SOURce<hw>]:BB:EUTRa:UL:UE<st>:SL:SCI<ch0>:SUBChannel.....	789
[SOURce<hw>]:BB:EUTRa:UL:UE<st>:SL:SCI<ch0>:TAINd.....	791
[SOURce<hw>]:BB:EUTRa:UL:UE<st>:SL:SCI<ch0>:TIMGap.....	792
[SOURce<hw>]:BB:EUTRa:UL:UE<st>:SL:SCI<ch0>:TRP.....	790
[SOURce<hw>]:BB:EUTRa:UL:UE<st>:SL:SCI<ch0>:TXINdex.....	792
[SOURce<hw>]:BB:EUTRa:UL:UE<st>:SL:SCI<ch0>:TXMode.....	787
[SOURce<hw>]:BB:EUTRa:UL:UE<st>:SL:STATe.....	777
[SOURce<hw>]:BB:EUTRa:UL:UE<st>:SL:SYNC:INCoverage.....	786
[SOURce<hw>]:BB:EUTRa:UL:UE<st>:SL:SYNC:OFFSetind.....	787
[SOURce<hw>]:BB:EUTRa:UL:UE<st>:SL:SYNC:SLSSid.....	787
[SOURce<hw>]:BB:EUTRa:UL:UE<st>:SL:SYNC:STATe.....	786
[SOURce<hw>]:BB:EUTRa:UL:UE<st>:SL:V2X:ADJC.....	783
[SOURce<hw>]:BB:EUTRa:UL:UE<st>:SL:V2X:BITHigh.....	783
[SOURce<hw>]:BB:EUTRa:UL:UE<st>:SL:V2X:BITLow.....	782
[SOURce<hw>]:BB:EUTRa:UL:UE<st>:SL:V2X:BMPLength.....	782
[SOURce<hw>]:BB:EUTRa:UL:UE<st>:SL:V2X:OFFSet.....	779
[SOURce<hw>]:BB:EUTRa:UL:UE<st>:SL:V2X:SRBSubchan.....	784
[SOURce<hw>]:BB:EUTRa:UL:UE<st>:SL:V2X:SUBChannels.....	784
[SOURce<hw>]:BB:EUTRa:UL:UE<st>:SL:V2X:SUBSize.....	784
[SOURce<hw>]:BB:EUTRa:UL:UE<st>:STATe.....	748
[SOURce<hw>]:BB:EUTRa:UL:UE<st>[:CELL<ccid>]:FRC:ALRB.....	749
[SOURce<hw>]:BB:EUTRa:UL:UE<st>[:CELL<ccid>]:FRC:MODulation?.....	750
[SOURce<hw>]:BB:EUTRa:UL:UE<st>[:CELL<ccid>]:FRC:N2DMrs.....	750
[SOURce<hw>]:BB:EUTRa:UL:UE<st>[:CELL<ccid>]:FRC:PASize?.....	750
[SOURce<hw>]:BB:EUTRa:UL:UE<st>[:CELL<ccid>]:FRC:STATe.....	751
[SOURce<hw>]:BB:EUTRa:UL:UE<st>[:CELL<ccid>]:FRC:TNOBits?.....	751
[SOURce<hw>]:BB:EUTRa:UL:UE<st>[:CELL<ccid>]:FRC:TYPE.....	751
[SOURce<hw>]:BB:EUTRa:UL:UE<st>[:CELL<ccid>]:FRC:VRBoffset.....	752
[SOURce<hw>]:BB:EUTRa:UL:UE<st>[:CELL<ccid>]:PUSCh:CCODing:ICQioffset.....	759
[SOURce<hw>]:BB:EUTRa:UL:UE<st>[:CELL<ccid>]:PUSCh:CCODing:IHARqoffset.....	759
[SOURce<hw>]:BB:EUTRa:UL:UE<st>[:CELL<ccid>]:PUSCh:CCODing:IRloffset.....	760
[SOURce<hw>]:BB:EUTRa:UL:UE<st>[:CELL<ccid>]:PUSCh:CCODing:MODE.....	759
[SOURce<hw>]:BB:EUTRa:UL:UE<st>[:CELL<ccid>]:PUSCh:CCODing:OCQimin.....	760
[SOURce<hw>]:BB:EUTRa:UL:UE<st>[:CELL<ccid>]:PUSCh:CCODing:STATe.....	758
[SOURce<hw>]:BB:EUTRa:UL:UE<st>[:CELL<ccid>]:PUSCh:DATA.....	756
[SOURce<hw>]:BB:EUTRa:UL:UE<st>[:CELL<ccid>]:PUSCh:DSElect.....	757

[SOURce<hw>]:BB:EUTRa:UL:UE<st>[:CELL<ccidx>]:PUSCh:INITpattern.....	757
[SOURce<hw>]:BB:EUTRa:UL:UE<st>[:CELL<ccidx>]:PUSCh:NAPort.....	758
[SOURce<hw>]:BB:EUTRa:UL:UE<st>[:CELL<ccidx>]:PUSCh:PATtern.....	756
[SOURce<hw>]:BB:EUTRa:UL:UE<st>[:CELL<ccidx>]:PUSCh:SCRambling:STATe.....	758
[SOURce<hw>]:BB:EUTRa:UL:UE<st>[:CELL<ccidx>]:PUSCh:TXMode.....	757
[SOURce<hw>]:BB:EUTRa:UL:UE<st>[:CELL<ccidx>]:PUSCh:UPPTs:LDMRs.....	761
[SOURce<hw>]:BB:EUTRa:UL:UE<st>[:CELL<ccidx>]:PUSCh:UPPTs:NSYM.....	761
[SOURce<hw>]:BB:EUTRa:UL:UE<st>[:CELL<ccidx>]:PUSCh:UPPTs:STATe.....	760
[SOURce<hw>]:BB:EUTRa:UL:UE<st>[:CELL<ccidx>]:REFSig:DRS:DWOCc.....	762
[SOURce<hw>]:BB:EUTRa:UL:UE<st>[:CELL<ccidx>]:REFSig:DRS:ENHanced.....	763
[SOURce<hw>]:BB:EUTRa:UL:UE<st>[:CELL<ccidx>]:REFSig:DRS:POWoffset.....	762
[SOURce<hw>]:BB:EUTRa:UL:UE<st>[:CELL<ccidx>]:REFSig:SRS:BHOP.....	766
[SOURce<hw>]:BB:EUTRa:UL:UE<st>[:CELL<ccidx>]:REFSig:SRS:POWoffset.....	764
[SOURce<hw>]:BB:EUTRa:UL:UE<st>[:CELL<ccidx>]:REFSig:SRS:STATe.....	763
[SOURce<hw>]:BB:EUTRa:UL:UE<st>[:CELL<ccidx>]:REFSig:SRS:TT0.....	763
[SOURce<hw>]:BB:EUTRa:UL:UE<st>[:CELL<ccidx>]:REFSig:SRS[<srsidx>]:BSRS.....	766
[SOURce<hw>]:BB:EUTRa:UL:UE<st>[:CELL<ccidx>]:REFSig:SRS[<srsidx>]:CYCShift.....	765
[SOURce<hw>]:BB:EUTRa:UL:UE<st>[:CELL<ccidx>]:REFSig:SRS[<srsidx>]:ISRS.....	767
[SOURce<hw>]:BB:EUTRa:UL:UE<st>[:CELL<ccidx>]:REFSig:SRS[<srsidx>]:NAPort.....	764
[SOURce<hw>]:BB:EUTRa:UL:UE<st>[:CELL<ccidx>]:REFSig:SRS[<srsidx>]:NKTC.....	768
[SOURce<hw>]:BB:EUTRa:UL:UE<st>[:CELL<ccidx>]:REFSig:SRS[<srsidx>]:NRRc.....	769
[SOURce<hw>]:BB:EUTRa:UL:UE<st>[:CELL<ccidx>]:REFSig:SRS[<srsidx>]:NTRans.....	765
[SOURce<hw>]:BB:EUTRa:UL:UE<st>[:CELL<ccidx>]:REFSig:SRS[<srsidx>]:SUBF<subfidx>.....	766
[SOURce<hw>]:BB:EUTRa:UL:UE<st>[:CELL<ccidx>]:REFSig:SRS[<srsidx>]:TOFFset?.....	768
[SOURce<hw>]:BB:EUTRa:UL:UE<st>[:CELL<ccidx>]:REFSig:SRS[<srsidx>]:TRComb.....	768
[SOURce<hw>]:BB:EUTRa:UL:UE<st>[:CELL<ccidx>]:REFSig:SRS[<srsidx>]:TSRS?.....	767
[SOURce<hw>]:BB:EUTRa:UL:UE<st>[:CELL<ccidx>]:REFSig:SRS[<srsidx>]:UPPTsadd.....	765
[SOURce<hw>]:BB:EUTRa:UL[:CELL<ccidx>][:SUBF<st0>]:ALLoc<ch0>:PUSCh:CODWords.....	712
[SOURce<hw>]:BB:EUTRa:UL[:CELL<ccidx>][:SUBF<st0>]:ALLoc<ch0>:PUSCh:CONFLict?.....	706
[SOURce<hw>]:BB:EUTRa:UL[:CELL<ccidx>][:SUBF<st0>]:ALLoc<ch0>:PUSCh:CQI:BITS.....	718
[SOURce<hw>]:BB:EUTRa:UL[:CELL<ccidx>][:SUBF<st0>]:ALLoc<ch0>:PUSCh:CQI:CBITs?.....	717
[SOURce<hw>]:BB:EUTRa:UL[:CELL<ccidx>][:SUBF<st0>]:ALLoc<ch0>:PUSCh:CQI:CODWord?.....	719
[SOURce<hw>]:BB:EUTRa:UL[:CELL<ccidx>][:SUBF<st0>]:ALLoc<ch0>:PUSCh:CQI:PATtern.....	718
[SOURce<hw>]:BB:EUTRa:UL[:CELL<ccidx>][:SUBF<st0>]:ALLoc<ch0>:PUSCh:DRS:CYCShift.....	715
[SOURce<hw>]:BB:EUTRa:UL[:CELL<ccidx>][:SUBF<st0>]:ALLoc<ch0>:PUSCh:DRS:NDMRs<layer>?.....	713
[SOURce<hw>]:BB:EUTRa:UL[:CELL<ccidx>][:SUBF<st0>]:ALLoc<ch0>:PUSCh:FHOP:IIHBits.....	715
[SOURce<hw>]:BB:EUTRa:UL[:CELL<ccidx>][:SUBF<st0>]:ALLoc<ch0>:PUSCh:FHOP:STATe.....	714
[SOURce<hw>]:BB:EUTRa:UL[:CELL<ccidx>][:SUBF<st0>]:ALLoc<ch0>:PUSCh:FHOP:TYPE?.....	714
[SOURce<hw>]:BB:EUTRa:UL[:CELL<ccidx>][:SUBF<st0>]:ALLoc<ch0>:PUSCh:HARQ:BITS.....	716
[SOURce<hw>]:BB:EUTRa:UL[:CELL<ccidx>][:SUBF<st0>]:ALLoc<ch0>:PUSCh:HARQ:MODE.....	716
[SOURce<hw>]:BB:EUTRa:UL[:CELL<ccidx>][:SUBF<st0>]:ALLoc<ch0>:PUSCh:HARQ:NBUNDled.....	716
[SOURce<hw>]:BB:EUTRa:UL[:CELL<ccidx>][:SUBF<st0>]:ALLoc<ch0>:PUSCh:HARQ:PATtern.....	717
[SOURce<hw>]:BB:EUTRa:UL[:CELL<ccidx>][:SUBF<st0>]:ALLoc<ch0>:PUSCh:MAPPing.....	714
[SOURce<hw>]:BB:EUTRa:UL[:CELL<ccidx>][:SUBF<st0>]:ALLoc<ch0>:PUSCh:POWer.....	706
[SOURce<hw>]:BB:EUTRa:UL[:CELL<ccidx>][:SUBF<st0>]:ALLoc<ch0>:PUSCh:PRECoding:CBINdex.....	713
[SOURce<hw>]:BB:EUTRa:UL[:CELL<ccidx>][:SUBF<st0>]:ALLoc<ch0>:PUSCh:PRECoding:NAPused.....	713
[SOURce<hw>]:BB:EUTRa:UL[:CELL<ccidx>][:SUBF<st0>]:ALLoc<ch0>:PUSCh:PRECoding: NOLayers.....	712
[SOURce<hw>]:BB:EUTRa:UL[:CELL<ccidx>][:SUBF<st0>]:ALLoc<ch0>:PUSCh:PRECoding:SCHeme.....	712
[SOURce<hw>]:BB:EUTRa:UL[:CELL<ccidx>][:SUBF<st0>]:ALLoc<ch0>:PUSCh:RI:BITS.....	719

[:SOURce<hw>]:BB:EUTRa:UL[:CELL<ccid>][:SUBF<st0>]:ALLoc<ch0>:PUSCh:RI:PATteRn.....	720
[:SOURce<hw>]:BB:EUTRa:UL[:CELL<ccid>][:SUBF<st0>]:ALLoc<ch0>:PUSCh:SET<user>:RBCouNt..	704
[:SOURce<hw>]:BB:EUTRa:UL[:CELL<ccid>][:SUBF<st0>]:ALLoc<ch0>:PUSCh:SET<user>:VRBOffset	704
[:SOURce<hw>]:BB:EUTRa:UL[:CELL<ccid>][:SUBF<st0>]:ALLoc<ch0>:PUSCh:STATe.....	706
[:SOURce<hw>]:BB:EUTRa:UL[:CELL<ccid>][:SUBF<st0>]:ALLoc<ch0>[:CW<cwid>]:PUSCh: CCODing:RVINdex.....	721
[:SOURce<hw>]:BB:EUTRa:UL[:CELL<ccid>][:SUBF<st0>]:ALLoc<ch0>[:CW<cwid>]:PUSCh: CCODing:TBSiZe.....	721
[:SOURce<hw>]:BB:EUTRa:UL[:CELL<ccid>][:SUBF<st0>]:ALLoc<ch0>[:CW<cwid>]:PUSCh: HARQ:CBITs?.....	717
[:SOURce<hw>]:BB:EUTRa:UL[:CELL<ccid>][:SUBF<st0>]:ALLoc<ch0>[:CW<cwid>]:PUSCh: PHYSbits?.....	705
[:SOURce<hw>]:BB:EUTRa:UL[:CELL<ccid>][:SUBF<st0>]:ALLoc<ch0>[:CW<cwid>]:PUSCh:RI: CBITs?.....	719
[:SOURce<hw>]:BB:EUTRa:UL[:CELL<ccid>][:SUBF<st0>]:ALLoc<ch0>[:CW<cwid>]:PUSCh: ULSCh:BITs?.....	720
[:SOURce<hw>]:BB:EUTRa:UL[:CELL<ccid>][:SUBF<st0>]:ALLoc<ch0>[:CW<cwid>][:PUSCh]: MODulation.....	703
[:SOURce<hw>]:BB:EUTRa:UL[:CELL<ccid>][:SUBF<st0>]:SLOT<user0>:ALLoc<ch0>:PUSCh: SET<gr>:RBOffset?.....	705
[:SOURce<hw>]:BB:EUTRa:UL[:PLCI]:CID.....	595
[:SOURce<hw>]:BB:EUTRa:UL[:PLCI]:CIDGroup.....	595
[:SOURce<hw>]:BB:EUTRa:UL[:PLCI]:PLID.....	596
[:SOURce<hw>]:BB:EUTRa:UL[:SUBF<st0>]:ALLoc<ch0>:CONFlit?.....	706
[:SOURce<hw>]:BB:EUTRa:UL[:SUBF<st0>]:ALLoc<ch0>:CONType.....	703
[:SOURce<hw>]:BB:EUTRa:UL[:SUBF<st0>]:ALLoc<ch0>:POWer.....	706
[:SOURce<hw>]:BB:EUTRa:UL[:SUBF<st0>]:ALLoc<ch0>:PUCCh:CONFlit?.....	706
[:SOURce<hw>]:BB:EUTRa:UL[:SUBF<st0>]:ALLoc<ch0>:PUCCh:CQI:BITs.....	724
[:SOURce<hw>]:BB:EUTRa:UL[:SUBF<st0>]:ALLoc<ch0>:PUCCh:CQI:CBITs?.....	724
[:SOURce<hw>]:BB:EUTRa:UL[:SUBF<st0>]:ALLoc<ch0>:PUCCh:CQI:PATteRn.....	724
[:SOURce<hw>]:BB:EUTRa:UL[:SUBF<st0>]:ALLoc<ch0>:PUCCh:CYCShifT.....	725
[:SOURce<hw>]:BB:EUTRa:UL[:SUBF<st0>]:ALLoc<ch0>:PUCCh:DMR1.....	726
[:SOURce<hw>]:BB:EUTRa:UL[:SUBF<st0>]:ALLoc<ch0>:PUCCh:DMR2?.....	726
[:SOURce<hw>]:BB:EUTRa:UL[:SUBF<st0>]:ALLoc<ch0>:PUCCh:HARQ:BITs.....	723
[:SOURce<hw>]:BB:EUTRa:UL[:SUBF<st0>]:ALLoc<ch0>:PUCCh:HARQ:CBITs?.....	723
[:SOURce<hw>]:BB:EUTRa:UL[:SUBF<st0>]:ALLoc<ch0>:PUCCh:HARQ:PATteRn.....	723
[:SOURce<hw>]:BB:EUTRa:UL[:SUBF<st0>]:ALLoc<ch0>:PUCCh:MRB.....	725
[:SOURce<hw>]:BB:EUTRa:UL[:SUBF<st0>]:ALLoc<ch0>:PUCCh:NAPused?.....	722
[:SOURce<hw>]:BB:EUTRa:UL[:SUBF<st0>]:ALLoc<ch0>:PUCCh:NOC.....	725
[:SOURce<hw>]:BB:EUTRa:UL[:SUBF<st0>]:ALLoc<ch0>:PUCCh:NPAR<ap>.....	722
[:SOURce<hw>]:BB:EUTRa:UL[:SUBF<st0>]:ALLoc<ch0>:PUCCh:PHYSbits?.....	705
[:SOURce<hw>]:BB:EUTRa:UL[:SUBF<st0>]:ALLoc<ch0>:PUCCh:POWer.....	706
[:SOURce<hw>]:BB:EUTRa:UL[:SUBF<st0>]:ALLoc<ch0>:PUCCh:RBCouNt?.....	704
[:SOURce<hw>]:BB:EUTRa:UL[:SUBF<st0>]:ALLoc<ch0>:PUCCh:STATe.....	706
[:SOURce<hw>]:BB:EUTRa:UL[:SUBF<st0>]:ALLoc<ch0>:PUSCh:ULSCh:BITs<cw>?.....	721
[:SOURce<hw>]:BB:EUTRa:UL[:SUBF<st0>]:ALLoc<ch0>:RBCouNt.....	704
[:SOURce<hw>]:BB:EUTRa:UL[:SUBF<st0>]:ALLoc<ch0>:STATe.....	706
[:SOURce<hw>]:BB:EUTRa:UL[:SUBF<st0>]:ALLoc<ch0>:VRBOffset.....	704
[:SOURce<hw>]:BB:EUTRa:UL[:SUBF<st0>]:ALLoc<ch0>[:CW<cwid>]:PHYSbits?.....	705
[:SOURce<hw>]:BB:EUTRa:UL[:SUBF<st0>]:ALLoc<ch0>[:PUCCh]:FORMat.....	703

[:SOURCE<hw>]:BB:EUTRa:UL[:SUBF<st0>]:CYCPrefix.....	702
[:SOURCE<hw>]:BB:EUTRa:UL[:SUBF<st0>]:SLOT<user0>:ALLOc<ch0>:PUCCh:RBOFFset?.....	705
[:SOURCE<hw>]:BB:EUTRa:UL[:SUBF<st0>]:SLOT<user0>:ALLOc<ch0>:RBOFFset?.....	705
[:SOURCE<hw>]:BB:EUTRa:UPLane:STATe.....	560
[:SOURCE<hw>]:BB:EUTRa:WAVEform:CREate.....	560
[:SOURCE<hw>]:BB:EUTRa[:TRIGger]:SEQuence.....	570

Index

Symbols

(E)PDCCH	
ECCE	189
Format	188
N [^] EPDCCH_ECCE	189
3D	
Beamforming	57
MIMO	57
Steering	57
A	
A/N + SRS simultaneous transmission	236
A/N Pattern	324
A/N+SR Pattern	324
A/N+SR+CSI bits	326
A/N+SR+CSI pattern	326
ACK/NACK mode	
Bundling	317
Multiplexing	317
ACK/NACK Pattern	317, 324
PHICH Group	175
ACK/NACK+SR Pattern	324
ACK/NACK+SR+CSI Bits	326
Activate DMRS with OCC for one antenna port	267
Activate-DMRS-with OCC	267
Aggregation	
FDD and TDD spectrum	52
Allocated resource blocks	260
Allocation	
Data source	169
Allocation number	165
Alpha offset	
Type 2 common search space	379
UE-specific search space	379
Antenna port	454
0, 1, 2 and 3	26
4	28
5	29
6	30
7 and 8	29
7 to 10	29
15 to 22	31
15 to 46	31
107 to 110	50
Definition	25
Downlink	206
Mapping	206, 455
Mapping data format	207
Mapping, coordinates	455
Antenna port mapping	
AP 4, AP 6	216
AP 7 to AP 14	217
Method	217
Antenna port to baseband mapping	304
Antenna ports	
Used by PUCCH	322
Antenna ports number	
CSI-RS	113, 120
Aperiodic SRS	270
Configuration index	277
Enable per user	136

SRS set	271
Transmissions number	277
Append	
DCI	182
Application cards	15
Application notes	15
ARB sequence	
Adjust	278
ARB sequence length	
Adjust	144
Current	144
Suggested	144
Area ID (N_ID_MBSFN)	87
Arm trigger	547
Armed_Auto	545
Armed_Retrigger	545
Auto	545
Automatic Offset Calculation	169
B	
Bandwidth	
channel	93
Component carrier	74
UL CA	224
Base sequence	
12 tone sequence	410
Six tone sequence	410
Three tone sequence	410
Base Station Class	503
Baseband filter	532
Beamforming	125
Settings	43
Behavior in unscheduled RE	128
Bit data	383, 436
Bit Data	190
Brochures	14
Bundling ACK/NACK mode	317
C	
Carrier aggregation	
Activate	132
Configuration, DL	70
Configuration, UL	219
How to	72, 221
Settings	46, 73
State	74, 224
Carrier indicator field (CIF)	185, 190
Carrying out a test case	511
Catalog	
User filter	533
CCE index	189
Cell	
Antenna port mapping	218
Cell ID	507
Override	255
UE-specific	255
Cell index	74, 185
Show in time plan	111, 174, 484
UL CA	224

- Cell-specific CSI-RS
 - Delta_CSI-RS 113
 - I_CSI-RS 113
 - Power 113
 - Q-offset 120
 - Scrambling identity 113
 - Subframe offset 120
 - T_CSI-RS 113
 - Cell-specific CSI-RS structure 112
 - Channel bandwidth 506
 - UL 226
 - Channel coding
 - State 210
 - Type 211, 451, 457
 - Channel coding state
 - PUSCH 265
 - Channel-state information 31
 - CIF 75
 - Clipping
 - Level 537
 - Mode 538
 - Clock source 553
 - Clustered PUSCH 250
 - Codebook 42
 - Codebook index 454
 - Constant in all subframes 217
 - Downlink 207
 - Set 206, 218
 - Uplink 313
 - Varying on a subframes basis 217
 - Coded A/N+SR+CSI Bits 326
 - Coded ACK/NACK+SR+CSI Bits 326
 - Codeword 165, 249
 - Definition 41
 - Codewords
 - Downlink 205
 - Uplink 313
 - Common subframe allocation period 90
 - Common trigger settings 545
 - Component carrier 74
 - Show in time plan 111, 174, 484
 - UL CA 224
 - Configuration
 - CSI-RS 114, 120
 - Configuration index I_SRS 272
 - Configuration mode 64
 - Configuration period T_SFC 236
 - Conflict 189, 253
 - DL 171
 - eMTC allocations 444
 - NB-IoT allocations 393
 - resolve 183
 - Content DCI format 188
 - Content Type 249, 312, 322
 - DL 170
 - Control region for PDCCH 76
 - Control Region for PDCCH 172
 - Conventions
 - SCPI commands 554
 - Coupled trigger settings 545
 - CQI Pattern 319, 326
 - CSI awareness
 - PDSCH settings 208
 - UE settings 136
 - CSI reference signals
 - Settings 32
 - CSI-RS 31
 - Activating several configurations 112
 - Antenna ports number 113, 120
 - CDM type 114
 - Configuration 114, 120
 - Frequency density 114
 - n_ID 113
 - N_ports_CSI 113, 120
 - N_res_CSI 112
 - State 112
 - Transmission comb 115
 - CSI-RS configuration
 - Non-Zero transmission power 114, 120
 - Zero transmission power 112, 119
 - CSI-RS structure
 - Cell-specific 112
 - Non-zero transmission power 112
 - ZeroTxPower 112, 118
 - Cut Off frequency shift 535
 - Cutoff frequency factor 536
 - Cyclic delay diversity (CDD) 207, 454
 - Cyclic prefix 98, 248, 507
 - Cyclic Prefix 163, 230
 - Cyclic shift
 - DMRS 314, 327
- ## D
- DAT file 533
 - Data format
 - Antenna port mapping 207
 - Data sheets 14
 - Data source
 - Dummy CCE 182
 - PDCCH 180
 - PUSCH 263
 - User configuration 135
 - DCI
 - Format 381, 435
 - MPDCCH set 435
 - n_RNTI 381, 435
 - Search space 382, 435
 - User 381, 434
 - DCI conflict
 - Resolving 946
 - DCI format 186
 - 0 190
 - 1 191
 - 1A 192
 - 1B 194
 - 1C 195, 196, 197
 - 1D 198
 - 2 199
 - 2A 199
 - 2B 199
 - 2C 199
 - 3 201, 436
 - 3A 201, 436
 - 6-0A 436
 - 6-0B 436
 - 6-1A 438
 - 6-1B 438
 - 6-2 441
 - eIMTA 196
 - LAA 197
 - N0 383

- N1 385
- N2 389
- Default settings
 - LTE 62
- Delay
 - Marker 552
 - SCell 78, 225
 - Trigger 549
- Delete
 - DCI 182
 - User filter 533
- Delta sequence shift
 - NPUSCH 409
- Delta sequence shift for PUSCH 235
- Delta shift 241, 473
- Delta t
 - PRACH 310
- DL carrier aggregation
 - UL carrier state 134
- DL cyclic prefix 98, 232
- DM-RS
 - see DMRS 29
- DMRS
 - Alternative table 137
 - Enable enhanced mapping 268
 - Enable enhanced mapping 315
 - Power offset 267
 - see UE-specific reference signal 29
- DMRS index 315, 328
- Documentation overview 13
- Down, up
 - DCI 182
- Downlink 64
- Downlink control channels
 - Settings 24
- Downlink reference signals
 - Settings 25
- DRMS index 235
- UL CA 225
- Dummy CCE REGs 181
- Dummy data
 - Modulation 129
 - Omit PRS subframes 130
 - Power 130
 - Source 129
- Duplexing 64, 506
- UL CA 75
- Dynamic range 523
- E**
- E-RNTI 255
- eIMTA
 - DCI format 1C 196
 - RNTI 136
 - UL/DL configuration number 196
- eMTC
 - Absolute subframes 464
 - ACK/NACK mode 468
 - ACK/NACK pattern 476
 - ACK/NACK pattern 468
 - CE level 461
 - CE mode 461
 - Control region 429
 - CQI pattern 469, 476
 - DL bitmap 429
 - DMRS configuration 467
 - DMRS cyclic shift 467
 - DMRS index 467
 - n_PUCCH 475
 - n(2)_DMRS 467
 - Number of A/N bits 468
 - Number of coded A/N bits 468
 - Number of coded CQI bits 469, 476
 - Number of coded UL-SCH bits 469
 - Number of CQI bits 469, 476
 - Number of RB per NB 464
 - Number of RB per WB 465
 - Number of repetitions, PUCCH 463
 - Number of repetitions, PUSCH 463
 - Number of used antenna ports 475
 - PDSCH scheduling 429
 - PUCCH allocations 462
 - PUCCH enhanced settings 463
 - PUCCH format 462, 475
 - PUCCH power 465
 - PUCCH, enable 462
 - PUSCH allocations 462
 - PUSCH enhanced settings 463
 - PUSCH modulation 462
 - PUSCH power 465
 - PUSCH, enable 462
 - Scheduling info 429
 - Shift of RB in the NB 465
 - Shift of RB in the WB 465
 - SIB1-BR 429
 - Start NB 464
 - Start WB 465
 - Starting redundancy version index (rv_idx) 469
 - Total number of physical bits 469
 - Transmission number 462
 - Transmission start SF 463
 - Transport block size/payload 469
 - Valid SF 429
- eMTC allocation
 - Channel 445
 - Conflict 448
 - Data source 447
 - DCI, disable 434
 - DCI, number 434
 - Modulation 446
 - Narrowband, first 447
 - Number 445
 - Phys. bits 447
 - Resource blocks, how many 447
 - Resource blocks, offset 447
 - Rho A 448
 - State 448
 - Subframes, absolute 447
 - Subframes, start 446
 - Symbol, first 447
- Enhanced settings 165, 250
 - Cyclic delay diversity 207
 - Precoding scheme 172
- Enhanced Settings
 - Redundancy Version Index 321
- Enhanced uplink
 - Settings 47
- EPDCCH
 - Activate per user and per carrier 150
 - DCI configuration 186
 - DMRS identity 150
 - dmrs-ScramblingSequenceInt-r11 151
 - numberPRB-Pairs-r11 150

- PRB pairs number 150
 - Relative power 151
 - Resource block assignment 151
 - Resource block pairs 150
 - resourceBlockAssignment 151
 - Scrambling 151
 - Set, enabling 150
 - UE-specific scrambling sequence 151
 - EUTRA/LTE operating bands 498
 - External trigger delay 549
- F**
- Fall offset 551
 - FD-MIMO
 - CDM type 114
 - FD-MIMO (Full-dimension MIMO)
 - Multiple CSI-RS configurations 112
 - FDD and TDD
 - Combination 52
 - FDD frame structure
 - Settings 20
 - FFT size 94, 227
 - Filter
 - Mode 536
 - Optimization 532
 - Type 532
 - First subframe
 - Time plan 484, 485, 487, 489, 491, 492
 - FRC 259, 406, 507
 - Modulation 407
 - NPUSCH repetitions 407
 - Payload size 407
 - Physical bits 408
 - Resource units 408
 - State 406
 - Transport block size index 407
 - FRC state 259
 - Freq. domain position n_{DRC} 277
 - Frequency Allocation 505
 - Frequency hopping
 - Interval 431
 - interval-DLHoppingConfigCommon 431
 - mpdcch-pdsch-HoppingNB-r13 430
 - mpdcch-pdsch-HoppingOffset-r13 430
 - Number of narrowbands 430
 - Offset 430
 - Paging 431
 - Random access (RA) 431
 - Starting narrowband for Paging 431
 - Starting narrowband for RA 431
 - Frequency Hopping 314
 - Frequency Hopping Type 314
 - Frequency offset 75
 - UL CA 224
 - Frequency resource index 309
- G**
- G
 - Type 2 common search space 379
 - UE-specific search space 379
 - Generate
 - Waveform file 63
 - Getting started 13
 - Global MIMO Configuration 125
- Group hopping 234
 - NB-IoT DMRS 409
 - Six tone cyclic shift 409
 - Three tone cyclic shift 409
 - groupHoppingDisabled 410
 - groupHoppingEnabled 409
- H**
- Help 14
 - High Speed Mode 239
 - Hopping bandwidth b_{hop} 276
 - Hopping-mode 239
- I**
- I_CQI_offset 265
 - I_HARQ_offset 265
 - I_RI_offset 265
 - In-channel selectivity 524
 - Information in Hopping Bits 314
 - Insert
 - DCI 182
 - Installation 13
 - Instrument help 14
 - Instrument security procedures 14
 - IR soft buffer size
 - PDSCH 212
- L**
- LAA
 - DCI format 1C 197
 - Subframe configuration 197
 - LAA burst
 - DCI 1C mode 162
 - Duration 161
 - First subframe 161
 - First symbol 161
 - Index 161
 - Last subframe 162
 - Number 161
 - Number of ending symbols 161
 - SCell index 161
 - Level reference 542
 - Link direction 64
 - Load
 - User filter 533
 - Logical root sequence index 310
 - LTE-A
 - MIMO, UL, and DL 47
- M**
- Mapping
 - Antenna port to baseband 304
 - Mapping coordinates 218
 - Mapping Coordinates 216
 - Mapping table 208, 216, 455
 - Antenna ports user defined 218
 - AP5 Tx 218
 - AP7 Tx 218
 - AP8 Tx 218
 - Marker Configuration 504
 - Marker delay 552
 - Marker delay time 552
 - Marker mode 550

- MBSFN
 - Settings 44
 - MBSFN reference signals 28
 - Settings 29
 - MBSFN-AreaInfoList 86, 87
 - MBSFN-NotificationConfig 86, 89
 - MBSFN-SubframeConfig 85
 - MBSFNAreaConfiguration 90
 - MCCH data source 89
 - MCCH MCS 89
 - MCCH modification period 88
 - MCCH offset 88
 - MCCH repetition period 88
 - MCCH State 88
 - MCCH transport block size 89
 - MCCS modulation 89
 - MCH Scheduling Period 92
 - MCS
 - Mode 144
 - Target code rate 145
 - Target modulation 145
 - Value 145
 - MCS PMCH 92
 - MIB 211
 - MIB-NB
 - Include in NBPCCH 400, 451
 - MIMO
 - Downlink, Rel. 10 47
 - Uplink, Rel. 10 47
 - MIMO modes 43
 - MIMO, downlink
 - Settings 40
 - Mixed FDD/TDD carriers 52
 - Mode
 - Channel coding 265
 - User equipment 256
 - Modulation 165, 249, 260
 - Dummy data 129
 - MPDCCH
 - Format 444
 - Hopping 151
 - Number of NCCEs 444
 - Repetitions 443
 - Search space 152
 - Start NB 151
 - Start subframe 443
 - MSC
 - Alternative table 137
 - Multiplexing ACK/NACK mode 317
 - Muted CSI-RS 112, 118
- N**
- N_bundled 317
 - n_PUCCH 322
 - n_RNTI 185
 - N_TA_offset 506, 549
 - N(1)_cs 242, 473
 - n(1)_DMRS 328
 - N(1)_RB 242, 474
 - n(2)_DMRS 261, 328
 - n(2)_DMRS per layer 315
 - Nap
 - Number of antenna ports for SRS 271
 - NB-LoT
 - AP for NRS 126
 - DL bitmap 374
 - Number of Tx antennas 126
 - Tx diversity 126
 - Valid SF 374
 - NB-LoT allocation
 - Carrier offset to center frequency 373, 414
 - Cell ID 373
 - Channel 394
 - Conflict 397
 - CRS sequence info 372
 - Data source 396
 - DCI, disable 381
 - DCI, number 381
 - Delta f 414
 - Frequency offset 373, 414
 - Mode 371, 415
 - Modulation 395
 - NCellID 373
 - NCellID group 373
 - NPUSCH allocations 415
 - Number 394
 - Phys. bits 396
 - RB, index 372, 380, 394, 414
 - Resource block index 372, 380, 394, 414
 - Rho A 397
 - State 397
 - Subcarrier spacing 414
 - Subframes 395
 - Transmission number 415
 - NB-LoT DL channels
 - Show on time plan 484, 487, 489, 492
 - NCCE index 393, 444
 - Ncs configuration 309
 - NDRS
 - Cyclic shift 409
 - Show on time plan 491
 - No of Configurable Subframes 128
 - PUCCH 245
 - PUSCH 245
 - No. of subframes
 - Time plan 484, 485, 487, 489, 491, 492
 - No. Of Used Allocations 164
 - No. RB 167, 250
 - No. Sym. 167
 - Non-MBSFN region length 87
 - Non-muted CSI-RS 112
 - NonZeroTxPower CSI-RS structure 118
 - Notification Indicator 88
 - Notification offset 90
 - Notification Pattern 90
 - Notification repetition coefficient 89
 - Notification subframe index 90
 - NPBCH
 - View per RB 484, 487, 489, 492
 - NPDCCH
 - Format 392
 - Number of NCCEs 393
 - Repetitions R 392
 - Start subframe 392
 - NPDSCH
 - Repetitions N_Rep 392
 - Subframes number N_SF 392
 - NPDSCH scheduling
 - Manual 391
 - NPRACH
 - Carrier offset to center frequency 426
 - Configuration 426
 - Configurations 424

- Frequency offset 426
- Mode 425
- Number of repetitions 425, 427
- Number of subcarriers 425
- Periodicity 424
- Power 427
- Preamble format 424
- Preamble repetitions 426
- Resource block 425
- Starting subframe 426, 427
- Starting time 424
- Subcarrier index 427
- Subcarrier offset 425
- View per RB 491
- NPRS**
 - Activate 121
 - Parameter 121
 - Power 122
 - Type A 121
 - Type B 121
- NPSS**
 - Power 104
 - Tx antenna 104
- NPSS, NSSS**
 - Show on time plan 484, 487, 489, 492
- NPUSCH**
 - ACK/NACK field 416
 - Channel coding and multiplexing 415
 - First SF 415
 - First slot 416
 - First subcarrier 417
 - Format 415
 - Modulation 415
 - Number of resource units 391
 - Number of RU 416, 420
 - Power 418
 - Repetitions 416
 - Slots 417
 - Start time 415
 - Starting SF 415
 - Starting slot 416
 - Subcarrier indication 416
 - Subcarrier number 417
 - View per RB 491
- NRS**
 - Power 104
 - View per RB 484, 487, 489, 492
- NSSS**
 - Power 104
 - Tx antenna 104
- Number CCEs 189
- Number of ACK/NACK bits 317
- Number of antenna ports
 - PUCCH format 257, 322, 474
 - PUSCH 264
 - SRS 271
- Number of AP
 - Uplink, PUSCH 313
- Number of available CCEs
 - PDCCH 178
- Number of available REGs
 - PDCCH 178
- Number of Bits
 - PDCCH 178
- Number of coded ACK/NACK bits 317
- Number of Coded CQI Bits 319, 326
- Number of coded RI bits 318
- Number of codewords
 - Downlink 205
 - Uplink 313
- Number of configurable frames 309
- Number of CQI Bits 319, 325
- Number of dummy CCEs 189
- Number of Dummy REGs 180
- Number of frames
 - Adjust 278
- Number of layers 172
 - Downlink 205
 - Precoding 399, 403, 450, 454
 - Uplink 313
- Number of PDCCHs 179
- Number of PHICH groups 174
- Number of physical bits
 - DL 211
- Number of Physical Bits for UL-SCH 320
- Number of PMCHs 91
- Number of RBs used for PUCCH 241, 472
- Number of REGs allocated to PDCCH 179
- Number of RI bits 318
- Number of Sub-bands 240
- NWUS Actual Duration 125
- NWUS Max Duration 124
- NWUS Paging Start Subframe 125
- NWUS Start SF 124
- NWUS State 124
- NWUS Time Offset 125
- NZP-TransmissionComb 112
- O**
 - O_CQI_Min 265
 - O_CQI-Min 265
 - Offset
 - Delta_CSI-RS 112, 113, 119
 - Q 120
 - SSS 120
 - Offset VRB 251, 261, 507
 - Omit dummy data in PRS subframes 130
 - Open source acknowledgment (OSA) 15
- P**
 - P_A 136
 - P-SYNC Power 103
 - P-SYNC Tx Antenna 103
 - P-SYNC, S-SYNC
 - Settings 28
 - Payload size 260
 - PBCH Settings 202
 - PCFICH
 - Power 172
 - PDCCH
 - Number of bits 178
 - Number of CCEs 178
 - Number of REGs 178
 - Power 178
 - PDCCH format 188
 - PDCCH Format 177
 - PDSCH
 - Hopping 443
 - Repetitions 443
 - PDSCH max repetitions 433
 - PDSCH P_B 98
 - PDSCH scheduling 69

- PDSCH Settings 202
 - Periodicity
 - T_CSI-RS 112, 113, 119
 - Periodicity T_SRS 272
 - PHICH
 - Power 175
 - Power Info 175
 - Power mode 174
 - Power Settings 175
 - PHICH duration 77, 99
 - PHICH N_g 76, 99
 - Phys. bits 252, 320
 - Phys. Bits 169
 - Physical bits per 261
 - Physical cell ID 74
 - UL CA 224
 - PMCH
 - Data source 92
 - Modulation 92
 - State 92
 - Use table 2 91
 - PMCH-InfoList 90, 91
 - positioning reference signals
 - Settings 31
 - Power 252
 - CSI-RS 113
 - MPDCCH 448
 - NPBCH 397
 - NPDCCH 397
 - NPDSCH 397
 - PBCH 170, 448
 - PCFICH 172
 - PDCCH 178
 - PDSCH 170, 448
 - PHICH 175
 - Power (PRACH) 310
 - Power Info 175
 - Power level 507
 - \hat{E}_c 514
 - IS 514
 - P-CPICH 514
 - Power mode 174
 - Power offset
 - DMRS 267
 - Power offset (SRS) 270
 - Power Settings 175
 - PRACH
 - CE level 479, 480
 - Configuration 479
 - Configuration eMTC 479
 - Delta t 482
 - Enable 256
 - Frequency offset 480
 - Frequency resource index 481
 - High-speed mode 479
 - Hopping 480
 - Hopping offset 479
 - Logical root sequence 481
 - Ncs 481
 - Number of preamble attempts 480
 - Power 482
 - RB offset 481
 - Repetitions 480, 481
 - Root sequence (u) 481
 - Sequence index 482
 - Settings 39
 - Starting SF 480, 481
 - PRACH Configuration 237
 - PRACH frequency offset 237
 - Preamble format 309
 - Preamble Set 239
 - Precoding
 - UL 313
 - Precoding scheme
 - Downlink 204
 - NPBCH 399
 - NPDCCH 403
 - NPDSCH 403
 - PBCH 450
 - PCFICH 172
 - PDCCH 172
 - PDSCH 453
 - PHICH 172
 - Uplink 313
 - PRS
 - Bandwidth 108
 - Configuration index 107
 - Muting info 108
 - Number of DL subframes (N_PRS) 108
 - Occasions deactivate 108
 - Periodicity T_PRS 107
 - Power 108
 - State 107
 - Subframe offset Delta_PRS 107
 - Pseudo-random sequence generator
 - Scrambling identity 120
 - PUCCH format
 - Number of antenna ports 257, 474
 - PUCCH Format 249, 322
 - PUCCH Format 3 326
 - PUCCH Format 4 326
 - PUCCH Format 5 326
 - PUCCH formats 36
 - PUSCH
 - Data list 263
 - Data pattern 263
 - Data source 263
 - Hopping interval 462
 - Hopping offset 460
 - N_ch_NB 462
 - Narrowband hopping 460
 - Set 1 250
 - PUSCH Hopping Offset 240
- ## R
- RA_RNTI 100
 - Radio frame allocation offset 86
 - Radio frame allocation period 86
 - Raised cosine filter
 - See Cosine filter 532
 - Range n(1)_PUCCH
 - Extended CP 242, 474
 - Normal CP 242, 474
 - Range n(2)_PUCCH 242, 474
 - Range n(3)_PUCCH 242
 - Range n(4)_PUCCH 243
 - Range n(5)_PUCCH 243
 - Ratio ρ_B/ρ_A
 - PBCH 98
 - PDCCH 98
 - PDSCH 98
 - RB offset 309

Receiver characteristics	
Tests overview	497
Redundancy version	145
Redundancy version index	
PDSCH	212
Redundancy Version Index	321
Reference channel	544
Reference sensitivity levels	522
Reference signal	
Mapping to antenna port	25
Reference Signal Power	102
Reference slot	544
Reference subframe	544
Reference UE	543
Release notes	15
Reset frame	248
Reset Frame	128
Reset table	183
Resource allocation configuration	
Auto Offset Calculation	169
Codeword	249
Conflict	171, 253
Content Type	249
Data source	169
Modulation	165
Modulation/Format	249
No. of physical bits	252, 320
No. of symbols	250
No.Of Physical Bits	169
No.Of Resource Blocks	167
No.of symbols	167
Power	170, 252
Resource Block Offset	168
State	170, 252
VRB Gap	166
Resource Allocation Configuration	
Codeword	165
UE Type	249
Resource Block Offset	168
Resource Block Offset Slot n	251
Resource blocks	
Per slot, DL	94
Per slot, UL	227
Restricted Set	239
Retrigger	545
RF frequency	506
RFC	
Allocated subcarriers	407
Subcarrier spacing	407
Rho A	170
RI Pattern	318
Rise offset	551
RLC counter	145
Rmax	
Type 1 common search space	378, 432
Type 2 common search space	378, 432
UE-specific search space	379
Rolloff factor	534
Root raised cosine filter	
See Root Cosine	532
Root sequence (u)	310
RRC filter	
See Root Cosine filter	532
RS power per RE relative to level display	102
RSTD Performance Tests	130
S	
S-SYNC Power	103
S-SYNC Tx Antenna	103
Safety instructions	14
Sample rate variation	536
Sampling rate	96
Save/Recall	
LTE	63
SCell index	74
UL CA	224
Scheduled cell index	76
Scheduling request (SR)	36
Scrambling	264
Configuration	135
DMRS identities, enabling	153
DMRS identity	153
PCFICH/PHICH/PDCCH	172
scramblingIdentity-rel11	153
scramblingIdentity2-rel11	153
State	153
Scrambling configuration	
Settings	147, 152
Scrambling DL	209
Script	
Generate user filter	533
Search space	187
Common	378, 432
UE-specific	379
Security procedures	14
Selective preset	508
Semi open loop	138
Semi-persistent scheduling	
Description	154
Settings	40, 153
Sequence hopping	234
Sequence index (v)	310
Sequence length	
ARB	538
Service manual	14
Set to default	
LTE	62
SF Alloc	
end	91
start	91
SFN offset	211
NPBCH	400
PBCH	451
Start value different than 0	231
SFN restart period	212, 451
Signal advance	506, 549
Signal duration unit	546
Signal generation status	546
Simulated Antenna	126
Single	545
SISO + BF	125
Sounding reference signal	
State	270
Spatial layer	
Definition	41
Spatial multiplexing	
Downlink	204
Uplink	313
Special subframe configuration	100, 233
UL CA	75, 225

- SPS
- Activation subframe number 158
 - C-RNTI 158
 - DCI fields 158
 - Enable 158
 - Enable per user 136
 - How to configure 155
 - Interval 158
 - PDCCH settings 158
 - Release subframe number 158
 - Settings 40
- SRS
- Additional UpPTS 271
 - Power offset 270
 - Set trigger type 270
 - State 270
 - Transmission in UpPTS 100, 233
- SRS bandwidth configuration B_SRS 274
- SRS bandwidth configuration C_SRC 236
- SRS Bandwidth Configuration C_SRC
- UL CA 225
- SRS cyclic shift 271
- SRS MaxUpPTS 236
- SRS set
- Per DCI 271
- SRS subframe configuration 236
- SRS Subframe Configuration
- UL CA 225
- SRS, aperiodic
- Enable per user 136
 - SRS set 271
- Standard settings
- LTE 62
- Start Subframe
- Type 2 common search space 432
- Starting RV 443
- State 252
- allocation 170
 - Channel coding 135, 210
 - Clipping 537
 - CSI-RS 112
 - LTE 62
 - PCFICH 172
 - PDCCH 172
 - PHICH 172
 - PRACH power ramping 307
 - SCell 78
 - SCell, UL 225
 - UE 254
 - User 132
- State (PRACH) 311
- Subframe Allocation Mode 86
- Subframe configuration
- I_CSI-RS 112, 113, 119
 - Offset 112, 113, 119, 120
 - Period 112, 113, 119
- Subframe information 248
- Subframe number 309
- Subframe offset T_offset 273
- Subframe selection 247
- Subframe Selection 163
- Supported test cases 496
- Symbol Offset 168
- SYNC Settings
- P-SYNC Power 103
 - S-SYNC Power 103
- T**
- TBS
- Alternative index 137
- TDD frame structure
- Settings 21
- TDD UL/DL configuration 506
- Test Case 503
- Test Frequencies 498
- Time domain windowing 530
- Time plan
- Enlarge 484, 486, 487, 489, 491, 493
 - Zoom in 484, 487, 489, 491, 492
- Time-based trigger
- State 546, 547
- Timing configuration
- Settings 549
- Total number of physical bits 252, 320
- Transition time 307, 531
- Transmission comb k TC 276
- Transmission direction 64
- Transmission mode
- Settings 133
 - UL 263
- Transmission modes 43
- Transmission offset Delta_SFC 236
- Transmission scheme 454
- Downlink 204
- Transmission using antenna port 5 29
- Required settings 205
- Transmission using antenna port 7 and 8
- Required settings 205
- Transmitter characteristics
- Tests overview 497
- Transport block size
- DL 212
 - NPBCH 402
 - NPDCCH 405
 - NPDSCH 405
 - PBCH 452
 - PDSCH 457
- Transport block size 320
- Trigger
- External, inhibit 547
- Trigger Configuration 504
- Trigger delay 549
- Actual 549
 - Expressed in time 549
 - Resulting 549
 - Unit 549
- Trigger mode 545
- Trigger signal duration 546
- Trigger source 547
- Trigger type 0
- Enable 270
- Trigger type 1
- Enable 270
- Tx mode
- Settings 133
- Tx Mode
- PDSCH 204, 454
- U**
- U-Plane 68
- UE category 134

UE ID	
DL	209
Scrambling	403, 450, 456
UE ID/n_RNTI	507
UE power	255
UE Type	249
UL carrier	
DL carrier aggregation	134
UL cyclic prefix	98, 232
Uplink	64
Uplink control channels	
Settings	37
Uplink data channels	
Settings	35
Uplink frame structure	
Settings	34
Uplink Frequency Hopping Mode	239
Uplink reference signals	
Settings	38
Uplink-downlink configuration	100, 233
Uplink-Downlink configuration	
Per component carrier	75, 224
UL CA	75, 224
Use base sequences	409
User	132, 184
User filter	
Create file	533
File format	533
Script	533
User manual	14
User plane	68
V	
Version	
3GPP standard	60
Videos	15
VRB Gap	166
W	
Waveform file	
Create	63
White papers	15
Z	
Zero transmission power	112, 118
CSI-RS	112, 119
Delta_CSI-RS	112, 119
I_CSI-RS	112, 119
T_CSI-RS	112, 119
ZeroPowerCSI-RS	112, 119
Number of configurations	119
ZeroTxPower CSI-RS structure	112, 118