

R&S® FPL-K40

Phase Noise Measurements User Manual

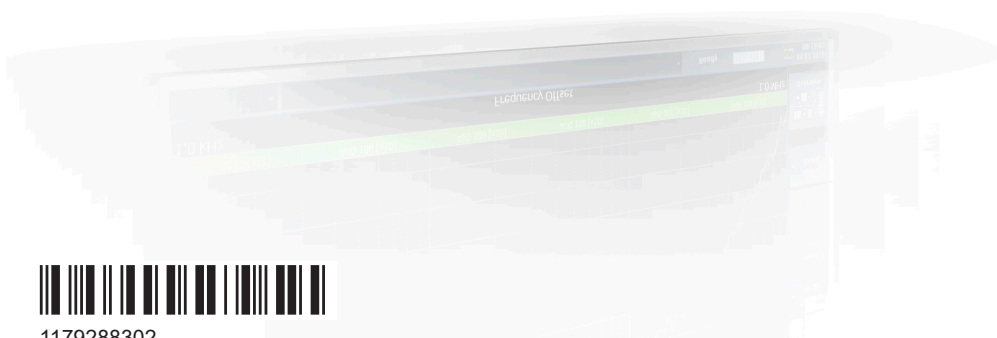

1179288302
Version 04

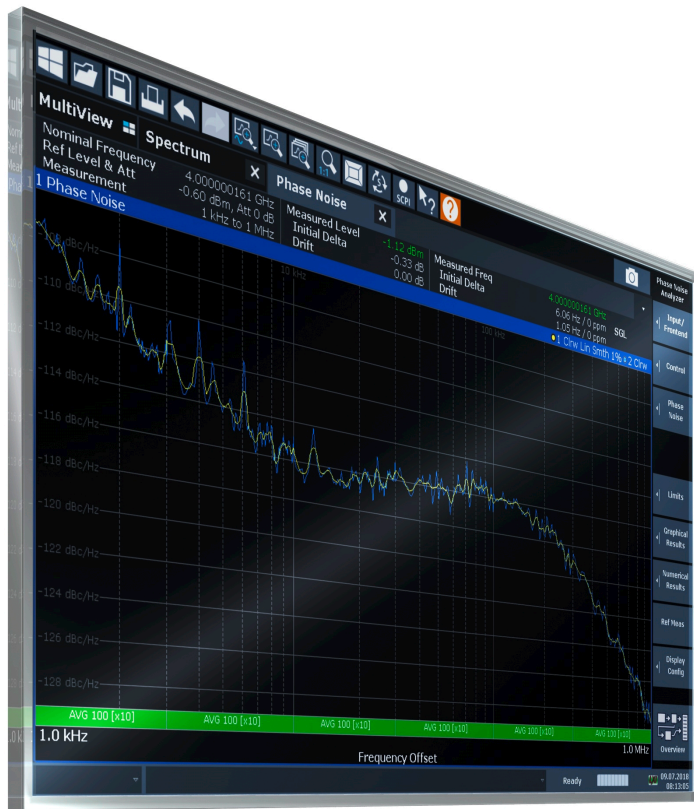

This manual applies to the following R&S®FPL1000 models with firmware version 2.10 and later:

- R&S®FPL1003 (1304.0004K03) - FPL1000 with maximum frequency 3 GHz
- R&S®FPL1007 (1304.0004K07) - FPL1000 with maximum frequency 7.5 GHz
- R&S®FPL1014 (1304.0004K14) - FPL1000 with maximum frequency 14 GHz
- R&S®FPL1026 (1304.0004K26) - FPL1000 with maximum frequency 26.5 GHz

The following firmware options are described:

- R&S FPL1000-K40 (1179.2883.02)

© 2023 Rohde & Schwarz GmbH & Co. KG
Muehldorfstr. 15, 81671 Muenchen, Germany
Phone: +49 89 41 29 - 0
Email: info@rohde-schwarz.com
Internet: www.rohde-schwarz.com

Subject to change – data without tolerance limits is not binding.

R&S® is a registered trademark of Rohde & Schwarz GmbH & Co. KG.

All other trademarks are the properties of their respective owners.

1179.2883.02 | Version 04 | R&S®FPL-K40 | COMPANY RESTRICTED

Throughout this manual, products from Rohde & Schwarz are indicated without the ® symbol , e.g. R&S®FPL is indicated as R&S FPL.

Contents

1	Preface	7
1.1	About this manual.....	7
1.2	Documentation overview.....	8
1.2.1	Getting started manual.....	8
1.2.2	User manuals and help.....	8
1.2.3	Service manual.....	8
1.2.4	Instrument security procedures.....	9
1.2.5	Printed safety instructions.....	9
1.2.6	Data sheets and brochures.....	9
1.2.7	Release notes and open-source acknowledgment (OSA).....	9
1.2.8	Application notes, application cards, white papers, etc.....	9
1.3	Conventions used in the documentation.....	10
1.3.1	Typographical conventions.....	10
1.3.2	Conventions for procedure descriptions.....	10
1.3.3	Notes on screenshots.....	10
2	Welcome to the phase noise measurement application	11
2.1	Starting the application.....	11
2.2	Understanding the display information.....	12
3	Measurements and result displays	16
4	Measurement basics	24
4.1	Spurs and spur removal.....	24
4.2	Residual effects.....	25
4.3	Measurement range.....	26
4.4	Sweep modes.....	27
4.5	Trace averaging.....	27
4.5.1	Half decade averaging.....	28
4.5.2	Sweep count.....	28
4.5.3	Trace smoothing.....	28
4.6	Frequency determination.....	29
4.7	Level determination.....	32

4.8	Signal attenuation.....	32
4.9	Using limit lines.....	33
4.10	Analyzing several traces - trace mode.....	35
4.11	Using markers.....	37
4.11.1	Marker types.....	37
4.11.2	Activating markers.....	37
5	Configuration.....	38
5.1	Configuration overview.....	38
5.2	Default settings for phase noise measurements.....	40
5.3	Configuring the frontend.....	40
5.4	Controlling the measurement.....	42
5.5	Configuring the measurement range.....	45
5.6	Performing measurements.....	49
5.7	Configuring in- and outputs.....	51
5.7.1	Input source configuration.....	51
5.7.2	Independent CW source settings.....	51
5.8	Automatic measurement configuration.....	52
6	Analysis.....	54
6.1	Configuring graphical result displays.....	54
6.1.1	Scaling the diagram.....	54
6.1.2	Configuring traces.....	56
6.1.3	Trace/data ex/import.....	58
6.1.4	Trace math.....	61
6.2	Configure numerical result displays.....	62
6.2.1	Configuring residual noise measurements.....	62
6.2.2	Configuring spot noise measurements.....	63
6.3	Using limit lines.....	64
6.3.1	Using phase noise limit lines.....	65
6.3.2	Selecting standard limit lines.....	66
6.3.3	Creating and editing standard limit lines.....	69
6.4	Using markers.....	71
7	How to configure phase noise measurements.....	75

7.1	Performing a basic phase noise measurement.....	75
7.2	Customizing the measurement range.....	75
8	Remote control commands for phase noise measurements.....	77
8.1	Common suffixes.....	77
8.2	Introduction.....	78
8.2.1	Conventions used in descriptions.....	78
8.2.2	Long and short form.....	79
8.2.3	Numeric suffixes.....	79
8.2.4	Optional keywords.....	80
8.2.5	Alternative keywords.....	80
8.2.6	SCPI parameters.....	80
8.2.6.1	Numeric values.....	81
8.2.6.2	Boolean.....	81
8.2.6.3	Character data.....	82
8.2.6.4	Character strings.....	82
8.2.6.5	Block data.....	82
8.3	Controlling the phase noise measurement channel.....	82
8.4	Performing measurements.....	86
8.5	Configuring the result display.....	90
8.5.1	General window commands.....	90
8.5.2	Working with windows in the display.....	91
8.6	Configuring the frontend.....	98
8.7	Controlling the measurement.....	99
8.8	Configuring the measurement range.....	103
8.9	Using limit lines.....	110
8.9.1	Using phase noise limit lines.....	110
8.9.2	Using standard limit lines.....	113
8.9.3	Creating and editing standard limit lines.....	117
8.10	Graphical display of phase noise results.....	120
8.11	Configure numerical result displays.....	133
8.11.1	Configuring residual noise measurements.....	133
8.11.2	Reading out residual noise results.....	135
8.11.3	Configuring spot noise measurements.....	138

8.11.4	Reading out the spur list.....	142
8.11.5	Reading out measured values.....	143
8.11.6	Reading out the sweep result list.....	143
8.12	Using markers.....	146
8.12.1	Using markers.....	147
8.12.2	Using delta markers.....	148
8.12.3	Configuring markers.....	151
8.12.4	Using the marker zoom.....	152
8.13	Configuring in- and outputs.....	153
8.14	Independant CW source commands.....	154
8.15	Automatic measurement configuration.....	156
8.16	Using the status register.....	157
8.16.1	Status registers for phase noise measurements.....	157
8.16.1.1	STATus:QUEStionable register.....	159
8.16.1.2	STATus:QUEStionable:POWer register.....	159
8.16.1.3	STATus:QUEStionable:LIMit register.....	160
8.16.1.4	STATus:QUEStionable:PNOise register.....	160
8.16.1.5	Status register remote commands.....	161
8.17	Remote control example scripts.....	163
8.17.1	Performing a basic phase noise measurement.....	163
8.17.2	Configuring the measurement range.....	164
8.17.3	Scaling the display.....	165
8.17.4	Configuring numerical results.....	166
8.17.5	Using limit lines.....	167
8.17.6	Using markers.....	168
	List of Commands (Phase Noise).....	169
	Index.....	174

1 Preface

1.1 About this manual

This User Manual provides all the information **specific to the application**. All general instrument functions and settings common to all applications and operating modes are described in the main R&S FPL1000 User Manual.

The main focus in this manual is on the measurement results and the tasks required to obtain them. The following topics are included:

- **Welcome to the Phase Noise Application**
Introduction to and getting familiar with the application
- **Typical applications**
Example measurement scenarios in which the application is frequently used.
- **Measurements and Result Displays**
Details on supported measurements and their result types
- **Phase Noise Measurement Basics**
Background information on basic terms and principles in the context of the measurement
- **Phase Noise Measurement Configuration + Analysis**
A concise description of all functions and settings available to configure measurements and analyze results with their corresponding remote control command
- **How to Perform Measurements with the Phase Noise Application**
The basic procedure to perform each measurement and step-by-step instructions for more complex tasks or alternative methods
- **Measurement Examples**
Detailed measurement examples to guide you through typical measurement scenarios and allow you to try out the application immediately
- **Optimizing and Troubleshooting the Measurement**
Hints and tips on how to handle errors and optimize the test setup
- **Remote Commands for Phase Noise Measurements**
Remote commands required to configure and perform phase noise measurements in a remote environment, sorted by tasks
(Commands required to set up the environment or to perform common tasks on the instrument are provided in the main R&S FPL1000 User Manual)
Programming examples demonstrate the use of many commands and can usually be executed directly for test purposes
- **Annex**
Reference material
- **List of remote commands**
Alphabetical list of all remote commands described in the manual
- **Index**

1.2 Documentation overview

This section provides an overview of the R&S FPL1000 user documentation. Unless specified otherwise, you find the documents at:

www.rohde-schwarz.com/manual/FSW

Further documents are available at:

www.rohde-schwarz.com/product/FSW

1.2.1 Getting started manual

Introduces the R&S FPL1000 and describes how to set up and start working with the product. Includes basic operations, typical measurement examples, and general information, e.g. safety instructions, etc.

A printed version is delivered with the instrument. A PDF version is available for download on the Internet.

1.2.2 User manuals and help

Separate user manuals are provided for the base unit and the firmware applications:

- Base unit manual
Contains the description of all instrument modes and functions. It also provides an introduction to remote control, a complete description of the remote control commands with programming examples, and information on maintenance, instrument interfaces and error messages. Includes the contents of the getting started manual.
- Firmware application manual
Contains the description of the specific functions of a firmware application, including remote control commands. Basic information on operating the R&S FPL1000 is not included.

The contents of the user manuals are available as help in the R&S FPL1000. The help offers quick, context-sensitive access to the complete information for the base unit and the firmware applications.

All user manuals are also available for download or for immediate display on the Internet.

1.2.3 Service manual

Describes the performance test for checking the rated specifications, module replacement and repair, firmware update, troubleshooting and fault elimination, and contains mechanical drawings and spare part lists.

The service manual is available for registered users on the global Rohde & Schwarz information system (GLORIS):

<https://gloris.rohde-schwarz.com>

1.2.4 Instrument security procedures

Deals with security issues when working with the R&S FPL1000 in secure areas. It is available for download on the internet.

1.2.5 Printed safety instructions

Provides safety information in many languages. The printed document is delivered with the product.

1.2.6 Data sheets and brochures

The data sheet contains the technical specifications of the R&S FPL1000. It also lists the firmware applications and their order numbers, and optional accessories.

The brochure provides an overview of the instrument and deals with the specific characteristics.

See www.rohde-schwarz.com/brochure-datasheet/FSW

1.2.7 Release notes and open-source acknowledgment (OSA)

The release notes list new features, improvements and known issues of the current firmware version, and describe the firmware installation.

The software makes use of several valuable open source software packages. An open-source acknowledgment document provides verbatim license texts of the used open source software.

See www.rohde-schwarz.com/firmware/FSW

1.2.8 Application notes, application cards, white papers, etc.

These documents deal with special applications or background information on particular topics.

See www.rohde-schwarz.com/application/FSW

1.3 Conventions used in the documentation

1.3.1 Typographical conventions

The following text markers are used throughout this documentation:

Convention	Description
"Graphical user interface elements"	All names of graphical user interface elements on the screen, such as dialog boxes, menus, options, buttons, and softkeys are enclosed by quotation marks.
[Keys]	Key and knob names are enclosed by square brackets.
Filenames, commands, program code	Filenames, commands, coding samples and screen output are distinguished by their font.
<i>Input</i>	Input to be entered by the user is displayed in italics.
Links	Links that you can click are displayed in blue font.
"References"	References to other parts of the documentation are enclosed by quotation marks.

1.3.2 Conventions for procedure descriptions

When operating the instrument, several alternative methods may be available to perform the same task. In this case, the procedure using the touchscreen is described. Any elements that can be activated by touching can also be clicked using an additionally connected mouse. The alternative procedure using the keys on the instrument or the on-screen keyboard is only described if it deviates from the standard operating procedures.

The term "select" may refer to any of the described methods, i.e. using a finger on the touchscreen, a mouse pointer in the display, or a key on the instrument or on a keyboard.

1.3.3 Notes on screenshots

When describing the functions of the product, we use sample screenshots. These screenshots are meant to illustrate as many as possible of the provided functions and possible interdependencies between parameters. The shown values may not represent realistic usage scenarios.

The screenshots usually show a fully equipped product, that is: with all options installed. Thus, some functions shown in the screenshots may not be available in your particular product configuration.

2 Welcome to the phase noise measurement application

The R&S FPL1000-K40 is a firmware application that adds functionality to measure the phase noise characteristics of a device under test with the R&S FPL1000 signal analyzer.

This user manual contains a description of the functionality that the application provides, including remote control operation.

Functions that are not discussed in this manual are the same as in the Spectrum application and are described in the R&S FPL1000 User Manual. The latest versions of the manuals are available for download at the product homepage.

Installation

Find detailed installing instructions in the Getting Started or the release notes of the R&S FPL1000.

- [Starting the application](#)..... 11
- [Understanding the display information](#)..... 12

2.1 Starting the application

The phase noise measurement application adds a new type of measurement to the R&S FPL1000.

To activate the Phase Noise application

1. Select the [MODE] key.

A dialog box opens that contains all operating modes and applications currently available on your R&S FPL1000.

2. Select the "Phase Noise" item.

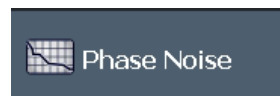

The R&S FPL1000 opens a new measurement channel for the Phase Noise application.

All settings specific to phase noise measurements are in their default state.

Multiple Measurement Channels and Sequencer Function

When you enter an application, a new measurement channel is created which determines the measurement settings for that application. The same application can be activated with different measurement settings by creating several channels for the same application.

The number of channels that can be configured at the same time depends on the available memory on the instrument.

Only one measurement can be performed at any time, namely the one in the currently active channel. However, in order to perform the configured measurements consecutively, a Sequencer function is provided.

If activated, the measurements configured in the currently active channels are performed one after the other in the order of the tabs. The currently active measurement is indicated by a  symbol in the tab label. The result displays of the individual channels are updated in the tabs (as well as the "MultiView") as the measurements are performed. Sequential operation itself is independent of the currently *displayed* tab.

For details on the Sequencer function see the R&S FPL1000 User Manual.

2.2 Understanding the display information

The following figure shows the display as it looks for phase noise measurements. All different information areas are labeled. They are explained in more detail in the following sections.

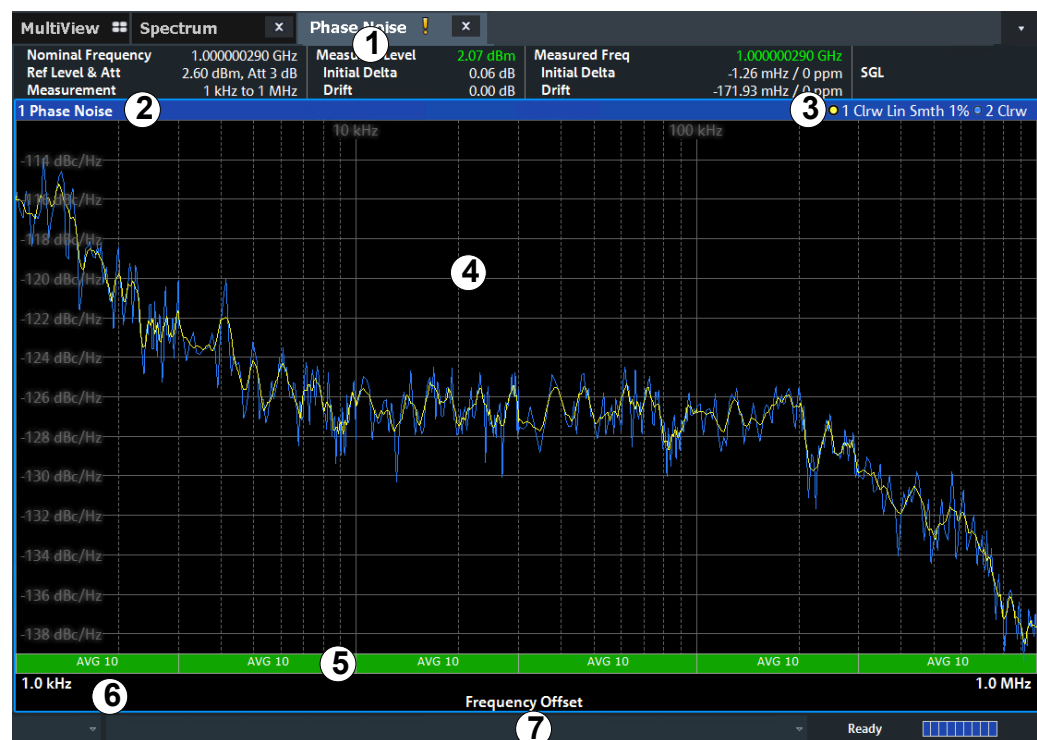

Figure 2-1: Screen layout of the phase noise measurement application

- 1 = Channel bar
- 2+3 = Diagram header
- 4 = Result display

- 5 = Measurement status
- 6 = Diagram footer
- 7 = Status bar

For a description of the elements not described below, please refer to the Getting Started of the R&S FPL1000.

Measurement status

The application shows the progress of the measurement in a series of green bars at the bottom of the diagram area. For each half decade in the measurement, the application adds a bar that spans the frequency range of the corresponding half decade.

The bar has several features.

- The numbers within the green bar show the progress of the measurement(s) in the half decade the application currently works on. The first number is the current, the second number the total count of measurements for that half decade. The last number is the time the measurement requires.
- A double-click on the bar opens an input field to define the number of averages for that half decade.
- A right-click on the bar opens a context menu.

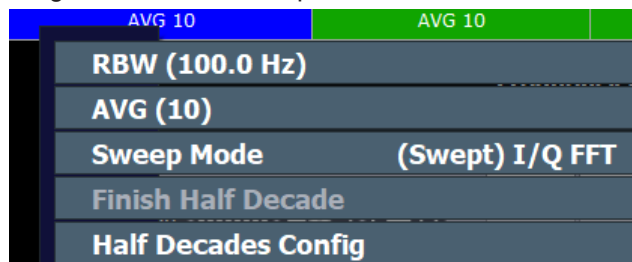

The context menu provides easy access to various parameters (resolution bandwidth, sweep mode etc.) that define the measurement characteristics for a half decade. The values in parentheses are the currently selected values. For more information on the available parameters see "[Half Decades Configuration Table](#)" on page 48.

Channel bar information

The channel bar contains information about the current measurement setup, progress and results.

Phase Noise					
Nominal Frequency	10.718361607 GHz	Measured Level	-25.87 dBm	Measured Freq	10.718361607 GHz
Ref Level & Att	-42.60 dBm, Att 0 dB	Initial Delta	-0.00 dB	Initial Delta	-1.20 GHz / -100835.9 ppm
Measurement	1 kHz to 1 MHz	Drift	0 dB	Drift	-2.65 kHz / -0.22 ppm

Figure 2-2: Channel bar of the phase noise application

Frequency	<p>Frequency the R&S FPL1000 has been tuned to.</p> <p>The frontend frequency is the expected frequency of the carrier. When frequency tracking or verification is on, the application might adjust the frontend frequency.</p>
Ref Level & Att	<p>Reference level (first value) and attenuation (second value) of the R&S FPL1000.</p> <p>When level tracking or verification is on, the application might adjust the frontend level.</p>
Measurement	Complete phase noise measurement range. For more information see Chapter 4.3, "Measurement range" , on page 26.
Measured Level	<p>DUT level that has been actually measured.</p> <p>The measured level might differ from the frontend level, e.g. if you are using level verification.</p>
Initial Delta	Difference between the nominal level and the first level that has been measured.
Drift	<p>Difference between the 1st level that has been measured and the level that has been measured last.</p> <p>In continuous sweep mode, the drift is the difference between the 1st level that has been measured in the 1st sweep and the level that has been measured last.</p>
Measured Frequency	<p>DUT frequency that has been actually measured.</p> <p>The measured frequency might differ from the frontend frequency, e.g. if you are using level verification.</p>
Initial Delta	Difference between the nominal frequency and the first frequency that has been measured.
Drift	<p>Difference between the 1st frequency that has been measured and the frequency that has been measured last.</p> <p>In continuous sweep mode, the drift is the difference between the 1st frequency that has been measured in the 1st sweep and the frequency that has been measured last.</p>
SGL [###]	Sweep mode (single or continuous). If you use trace averaging, it also shows the current measurement number out of the total number of measurements.

The following two figures show the relations between the frequency and level errors.

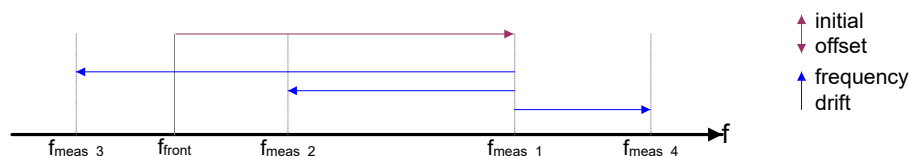

Figure 2-3: Frequency errors

f_{front} = initial frequency set on the frontend

f_{meas_x} = actual frequency that has been measured

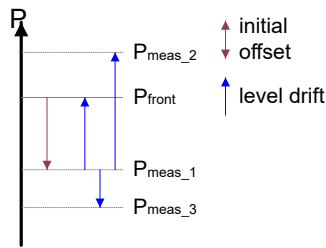

Figure 2-4: Level errors

P_{front} = reference level if tracking = off

P_{front} = initial reference level if tracking = on

P_{meas_1} = becomes reference level after first sweep if tracking = on

P_{meas_2} = becomes reference level after second sweep if tracking = on

P_{meas_3} = becomes reference level after third sweep if tracking = on

Window title bar information

For each diagram, the header provides the following information:



Figure 2-5: Window title bar information of the phase noise application

1 = Window number

2 = Window type

3 = Trace color and number

4 = Trace mode

5 = Smoothing state and degree

Status bar information

Global instrument settings, the instrument status and any irregularities are indicated in the status bar beneath the diagram. Furthermore, the progress of the current operation is displayed in the status bar.

3 Measurements and result displays

Access:

The Phase Noise application measures the phase noise of a single sideband of a carrier.

It features several result displays. Result displays are different representations of the measurement results. They may be diagrams that show the results in a graphic way or tables that show the results in a numeric way.

In the default state of the application, only the graphical display of phase noise results is active.

Phase Noise Diagram.....	16
Residual Noise.....	17
Spot Noise.....	18
Spur List.....	19
Sweep Result List.....	20
Spectrum Monitor.....	21
Frequency Drift.....	22
Frequency and Level Stability.....	22
Reference Measurement.....	23

Phase Noise Diagram

The phase noise diagram shows the power level of the phase noise over a variable frequency offset from the carrier frequency.

Measurement range

The unit of both axes in the diagram is fix. The x-axis always shows the offset frequencies in relation to the carrier frequency on a logarithmic scale in Hz. It always has a logarithmic scale to make sure of an equal representation of offsets near and far away from the carrier. The range of offsets that the x-axis shows is variable and depends on the measurement range you have defined and the scope of the x-axis that you have set.

For more information on the measurement range see [Chapter 4.3, "Measurement range"](#), on page 26.

If the measurement range you have set is necessary, but you need a better resolution of the results, you can limit the displayed result by changing the x-axis scope. The scope works like a zoom to get a better view of the trace at various points. It does not start a new measurement or alter the current measurements results in any way.

The y-axis always shows the phase noise power level contained in a 1 Hz bandwidth in relation to the level of the carrier. The unit for this information is dBc/Hz and is also fix.

Y-axis scale

The scale of the y-axis is variable. Usually it is best to use the automatic scaling that the application provides, because it makes sure that the whole trace is always visible. You can, however, also customize the range, the minimum and the maximum values on the y-axis by changing the y-axis scale.

The measurement results are displayed as traces in the diagram area. Up to six active traces at any time are possible. Each of those may have a different setup and thus show different aspects of the measurement results.

In the default state, the application shows two traces. A yellow one and a blue one. Both result from the same measurement data, but have been evaluated differently. On the first trace, smoothing has been applied, the second one shows the raw data.

For more information on trace smoothing see [Chapter 4.5, "Trace averaging"](#), on page 27.

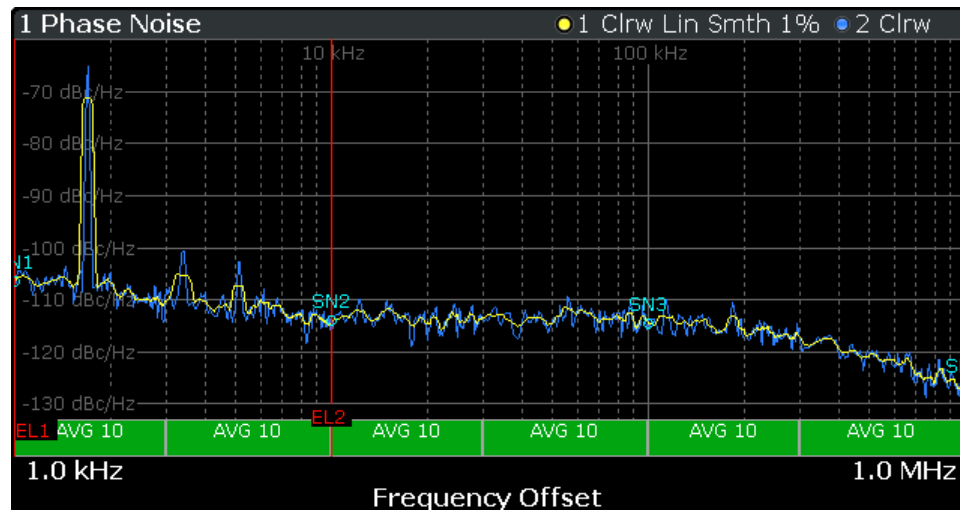

Figure 3-1: Overview of the phase noise result display

The figure above shows a phase noise curve with typical characteristics. Frequency offsets near the carrier usually have higher phase noise levels than those further away from the carrier. The curve has a falling slope until the thermal noise of the DUT has been reached. From this point on, it is more or less a straight horizontal line.

Remote command:

`TRACe<n> [:DATA]` on page 132

Residual Noise

The residual noise display summarizes the residual noise results in a table.

For more information on the residual noise results see [Chapter 4.2, "Residual effects"](#), on page 25.

The table consists of up to four rows with each row representing a different integration interval. Each row basically contains the same information with the exception that the first row always shows the results for the first trace and the other rows with custom integration ranges the results for any one trace.

2 Residual Noise						
Trace	Start Offset	Stop Offset	Int PHN	PM	FM	Jitter
T1	1.00 kHz	10.00 kHz	-50.15 dBc	251.81 m° / 4...	7.72 Hz	134.52 fs
T1	10.00 kHz	100.00 kHz	-63.80 dBc	52.32 m° / 91...	55.32 Hz	27.95 fs
T1	100.00 kHz	200.68 kHz	-64.34 dBc	49.17 m° / 85...	129.94 Hz	26.26 fs

The residual noise information is made up out of several values.

Type	Shows the number of the trace that is integrated (T[x]).
Start / Stop Offset	Shows the start and stop offset of the integration interval.
Int. PHN	Shows the Integrated Phase Noise. The integral is calculated over the frequency range defined by the Start and Stop Offset values.
PM	Shows the Residual PM result in degrees and rad.
FM	Shows the Residual FM results in Hz.
Jitter	Shows the Jitter in seconds.

For more information on residual noise see [Chapter 4.2, "Residual effects"](#), on page 25.

Remote command:

Querying Residual PM:

`FETCh:PNOise<t>:USER<range>:RPM?` on page 138

Querying Residual FM:

`FETCh:PNOise<t>:USER<range>:RFM?` on page 137

Querying Jitter:

`FETCh:PNOise<t>:USER<range>:RMS?` on page 137

Querying Integrated Phase Noise

Querying user ranges:

`FETCh:PNOise<t>:USER<range>:RFM?` on page 137

`FETCh:PNOise<t>:USER<range>:RMS?` on page 137

`FETCh:PNOise<t>:USER<range>:RPM?` on page 138

Spot Noise

Spot noise is the phase noise at a particular frequency offset (or spot) that is part of the measurement range. It is thus like a fixed marker.

The unit of spot noise results is dBc/Hz. The application shows the results in a table.

2 Spot Noise		
Type	Offset Frequency [T1]	Phase Noise [T1]
User 1	1.00 kHz	-115.33 dBc/Hz
User 2	10.00 kHz	-124.42 dBc/Hz
User 3	100.00 kHz	-122.67 dBc/Hz
User 4	1.00 MHz	-132.82 dBc/Hz
User 5	10.00 MHz	---

The table consists of a variable number of 10^x frequencies (depending on the measurement range), and a maximum of five user frequencies, with each row containing the spot noise information for a particular frequency offset.

The spot noise information is made up out of several variables.

Type	Shows where the spot noise offset frequency comes from. By default, the application evaluates the spot noise for the first offset frequency of a decade only (10 ^x Hz, beginning at 1 kHz). However, you can add up to five customized offsets frequencies that you want to know the phase noise for. If you want to use more custom offsets, you can add another spot noise table. The "User" label indicates a custom offset frequency.
Offset Frequency	Shows the offset frequency the spot noise is evaluated for. You may add any offset that is part of the measurement range. The number in brackets (T<x>) indicates the trace the result refers to.
Phase Noise	Shows the phase noise for the corresponding offset frequency. The number in brackets (T<x>) indicates the trace the result refers to.

Note that the spot noise results are calculated for a particular trace only. You can select the trace by tapping on the trace LED in the header of the result display.

1 Phase Noise ● 1 Clrw Lin Smth 1% ○ 2 Clrw

Remote command:

Querying spot noise results on 10^x offset frequencies:

[CALCulate<n>:SNOise<m>:DECades:X](#) on page 139

[CALCulate<n>:SNOise<m>:DECades:Y](#) on page 139

Querying custom spot noise results:

[CALCulate<n>:SNOise<m>:Y](#) on page 141

Trace selection: [DISPlay\[:WINDow<n>\]:TRACe<t>:SElect](#) on page 141

Spur List

Spurs are peak levels at one or more offset frequencies and are caused mostly by interfering signals. The application shows the location of all detected spurs in a table.

4 Spur List			
No	Offset Frequency	Power	Jitter
1	1.70 kHz	-50.20 dBc	133.82 fs
2	3.40 kHz	-80.59 dBc	4.04 fs
3	5.10 kHz	-82.42 dBc	3.28 fs
Total	Discrete Jitter		133.92 fs
	Random Jitter		12.62 fs

The table consists of a variable number of rows. For each detected spur, the table shows several results.

Number	Shows the spur number. Spurs are sorted by their frequency, beginning with the spur with the lowest frequency.
Offset Frequency	Shows the position (offset frequency) of the spur.

Power	Shows the power level of the spur in dBc.
Jitter	Shows the jitter value of the spur in s. In addition to the jitter for each spur, the result display also shows the Discrete Jitter and the Random Jitter at the end of the table. <ul style="list-style-type: none"> The Discrete Jitter is the RMS value of all individual jitter values. The Random Jitter is the difference of the overall jitter (as shown in the Residual Noise result display) and the Discrete Jitter. The result is an RMS value: $\text{RandomJitter}^2 = \text{Jitter}^2 - \text{DiscreteJitter}^2$

For more information see [Chapter 4.1, "Spurs and spur removal"](#), on page 24.

Remote command:

[FETCh:PNOise<t>:SPURs?](#) on page 142

[FETCh:PNOise<t>:SPURs:DISCcrete?](#) on page 142

[FETCh:PNOise<t>:SPURs:RANDom?](#) on page 142

Sweep Result List

The sweep result list summarizes the results of the phase noise measurement.

3 Sweep Result List						
Start	Stop	Sampling Rate	AVG	Freq Drift	Level Drift	Max Freq Drift
300.00 Hz	1.00 kHz	2.50 kHz	134	3.32 Hz	0.08 dB	35.94 mHz
1.00 kHz	3.00 kHz	7.50 kHz	1000	3.33 Hz	0.08 dB	82.92 mHz
3.00 kHz	10.00 kHz	25.00 kHz	1000	3.33 Hz	0.08 dB	219.37 mHz
10.00 kHz	30.00 kHz	75.00 kHz	1000	3.32 Hz	0.08 dB	553.48 mHz
30.00 kHz	100.00 kHz	250.00 kHz	1000	3.33 Hz	0.08 dB	2.17 Hz
100.00 kHz	300.00 kHz	750.00 kHz	1000	3.33 Hz	0.08 dB	11.45 Hz
300.00 kHz	1.00 MHz	2.50 MHz	1000	3.33 Hz	0.08 dB	105.11 Hz

The table consists of several rows with each row representing a half decade. The number of rows depends on the number of half decades analyzed during the measurement.

The sweep results are made up out of several values.

- Results in a red font indicate that the frequency drift is so large that the frequency has drifted into the range of a higher half decade. The result is therefore invalid.
- Results in a green font indicate the half decade that is currently measured.

Start / Stop	Shows the start and stop offset of the half decade.
Sampling Rate	Shows the sample rate used in the corresponding half decade.
AVG	Shows the number of measurements performed in the half decade to calculate the average (final) result.
Freq Drift	Shows the difference to the initial (nominal) frequency that was measured in the half decade. If you perform more than one measurement (averages) in the half decade, the value is updated for each single measurement. The last value that has been measured in the half decade will remain in the table.

Max Drift	Shows the highest difference to the initial (nominal) frequency that was measured in the half decade.
Level Drift	Shows the difference to the initial (nominal) level that was measured in the half decade. If you perform more than one measurement (averages) in the half decade, the value is updated for each single measurement. The last value that has been measured in the half decade will remain in the table.

Remote command:

Start offset: `FETCh:PNOise<t>:SWEep:START?` on page 145

Stop offset: `FETCh:PNOise<t>:SWEep:STOP?` on page 146

Sample rate: `FETCh:PNOise<t>:SWEep:SRATe?` on page 145

Averages: `FETCh:PNOise<t>:SWEep:AVG?` on page 143

Frequency drift: `FETCh:PNOise<t>:SWEep:FDRift?` on page 144

Max drift: `FETCh:PNOise<t>:SWEep:MDRift?` on page 145

Level drift: `FETCh:PNOise<t>:SWEep:LDRift?` on page 144

Spectrum Monitor

The spectrum monitor shows the spectrum for the half decade that is currently measured.

Span

The span on the x-axis is defined by the start and stop frequency of the half decade that is currently measured.

Y-axis scale

The scale of the y-axis is automatically determined according to the signal characteristics.

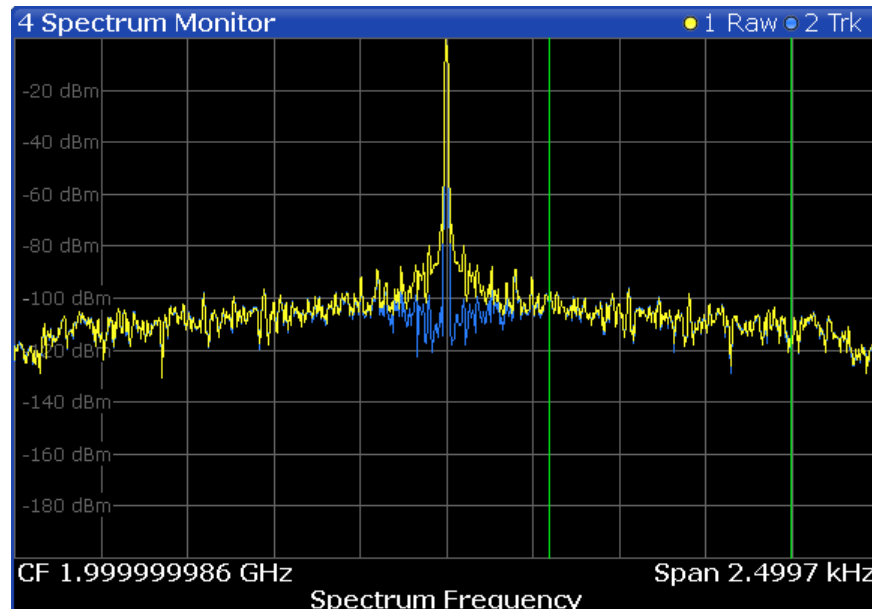

In I/Q mode, the result display contains two traces.

- The yellow trace ("raw trace") represents the live signal with the actual center frequency currently measured.

- The blue trace ("track trace") equalizes frequency drifting signals and thus shows a stable version of the signal with the intended center frequency.

If necessary, you can turn the traces on and off. For more information see "[Spectrum Monitor: Raw Trace / Trk Trace \(On Off\)](#)" on page 58.

The green vertical lines indicate the phase noise offset to be measured on in relation to the displayed center frequency. The position of the two green lines depends on the half decade that is currently measured and the sample rate you have selected.

Remote command:

`TRACe<n> [: DATA]` on page 132

Frequency Drift

The frequency drift shows the instantaneous frequency over time for the half decade that is currently measured.

Time span

The displayed time span on the x-axis is defined by the time it takes to perform a measurement in the half decade that is currently measured. If the measurement time for a particular half decade is very long (several seconds), the application probably updates the result display several times. In that case, the application splits the measurement into several "sub-measurements".

Y-axis scale

The scale of the y-axis is automatically determined according to the sample rate. For a better resolution, the trace is offset by the first measured frequency value. Thus, the trace always starts at 0 Hz. The initial correction value is displayed in the diagram as a numeric result.

To get a better resolution of the time axis, use the zoom function.

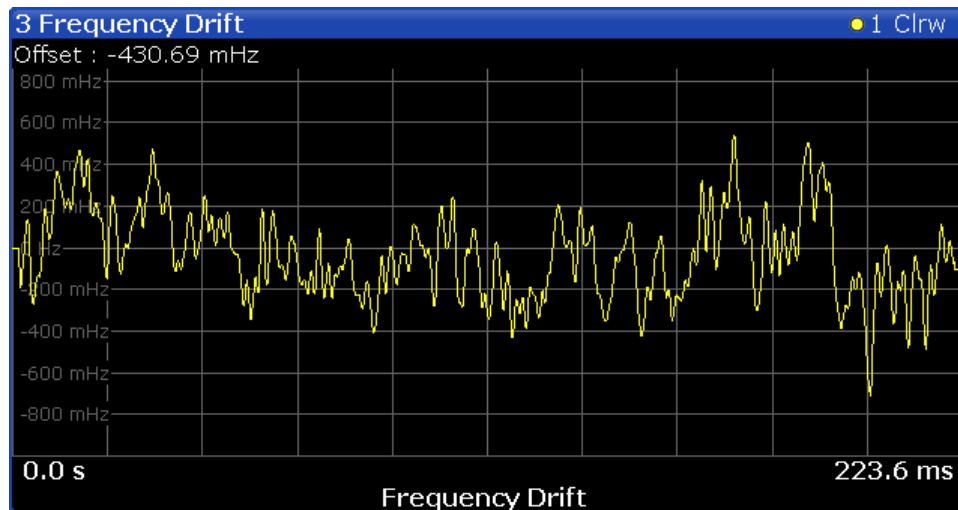





Frequency and Level Stability

The stability results show the current level and frequency drift characteristics of the carrier signal compared to the initial frequency and level. In addition to the numerical results, the result display also contains a graphical representation of the drift characteristics.

The result display contains the following results.

- **Carrier Stability**
Difference between the 1st frequency that has been measured and the frequency that has been measured last.
- **Δ to Ref Level**
Difference between the 1st level that has been measured and the level that has been measured last.

2 Frequency & Level Stability				
Type	Min	Indicator	Max	Value
Carrier Stability	-3.75 kHz		3.75 kHz	0.07 Hz
Δ to Ref Level				-0.51 dB

2 Frequency & Level Stability	
Carrier Stability	
Min	-3.75 kHz
Indicator	
Max	3.75 kHz
Value	0.07 Hz
Δ to Ref Level	
Indicator	
Value	-0.51 dB

The results correspond to the Level Drift and Frequency Drift results displayed in the channel bar. For more information see ["Channel bar information"](#) on page 13

Note that the results are only valid for I/Q FFT measurements (see ["Global Sweep Mode"](#) on page 48).

Reference Measurement

The reference measurement measures the inherent noise figure (DANL) of the R&S FPL1000.

To determine the inherent noise, you must remove the signal from the input. The application then performs a measurement without the signal. The resulting trace shows the inherent noise of the R&S FPL1000 only. When you subtract that inherent noise from the phase noise of the measurement with trace mathematics, you get a trace that shows the phase noise of the DUT only.

Remote command:

[CONFigure:REFMeas](#) on page 87

4 Measurement basics

The measurement basics contain background information on the terminology and principles of phase noise measurements.

Phase noise measurements in general determine the single sideband phase noise characteristics of a device under test (DUT).

• Spurs and spur removal	24
• Residual effects	25
• Measurement range	26
• Sweep modes	27
• Trace averaging	27
• Frequency determination	29
• Level determination	32
• Signal attenuation	32
• Using limit lines	33
• Analyzing several traces - trace mode	35
• Using markers	37

4.1 Spurs and spur removal

Most phase noise results contain unwanted spurs. Spurs are peak levels at one or more offset frequencies and are caused mostly by interfering signals. For some applications, you might want to identify the location of spurs. For other applications, spurs do not matter in evaluating the results and you might want to remove them from the trace to get a "smooth" phase noise trace.

Spur display

Usually, spurs are visible on the trace as a peak. In addition, the R&S FPL1000 draws a straight, vertical line to represent the position of a spur visually. The length of these lines indicates the level of the spur in dBc and refers to the scale on the right side of the phase noise diagram.

The lines indicating a spur are not part of the trace data. When you export the trace, for example, the spur data is not exported.

Spur suppression

The application allows you to (visually) remove spurs from the trace. Spur removal is based on an algorithm that detects and completely removes the spurs from the trace and fills the gaps with data that has been determined mathematically.

The spur removal functionality separates the actual spur power from the underlying phase noise and displays the latter in a two-stage process. The first stage of spur detection is based on an eigenvalue decomposition during the signal processing.

Spur threshold

During the second stage, the application uses statistical methods to remove a spur. A spur is detected, if the level of the signal is above a certain threshold. The spur threshold is relative to an imaginary median trace that the application calculates.

If parts of the signal are identified as spurs, the application removes all signal parts above that level and substitutes them with the median trace.

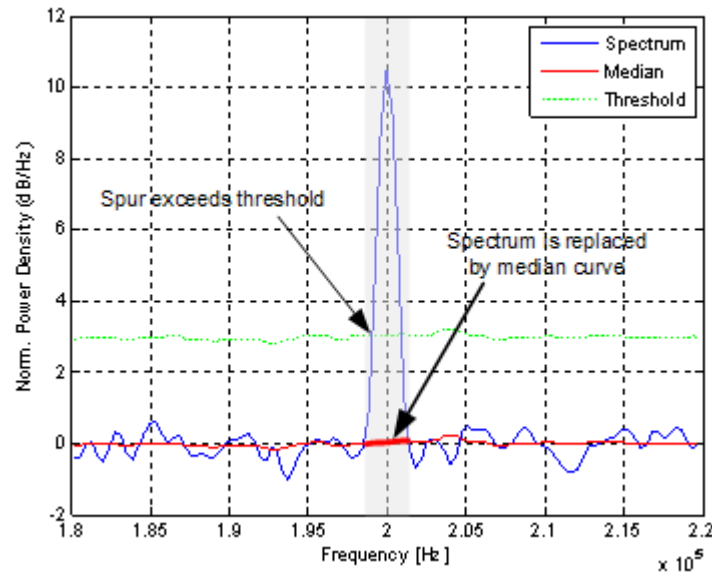

Figure 4-1: Spur detection and removal principle

4.2 Residual effects

Residual noise effects are modulation products that originate directly from the phase noise. It is possible to deduce them mathematically from the phase noise of a DUT.

The application calculates three residual noise effects. All calculations are based on an integration of the phase noise over a particular offset frequency range.

Residual PM

The residual phase modulation is the contribution of the phase noise to the output of a PM demodulator. It is evaluated over the frequency range you have defined.

$$\text{Residual PM} = \sqrt{2 \cdot \int_{f_{\text{start}}}^{f_{\text{stop}}} L(f_m) df_m} \text{ [rad]}$$

with $L(f)$ = single sideband phase noise [dBc/Hz]

Residual FM

The residual frequency modulation is the contribution of the phase noise to the output of an FM demodulator. It is evaluated over the frequency range you have defined.

$$\text{Residual FM} = \sqrt{2 \cdot \int_{f_{\text{start}}}^{f_{\text{stop}}} f_m^2 L(f_m) df_m} \text{ [Hz]}$$

with $L(f_m)$ = single sideband phase noise [dBc/Hz]

f_m = frequency [Hz]

Jitter

The jitter is the RMS temporal fluctuation of a carrier with the given phase noise evaluated over a given frequency range of interest.

$$\text{Jitter[s]} = \frac{\text{Residual PM [rad]}}{2\pi \cdot f_0}$$

with f_0 = Carrier frequency

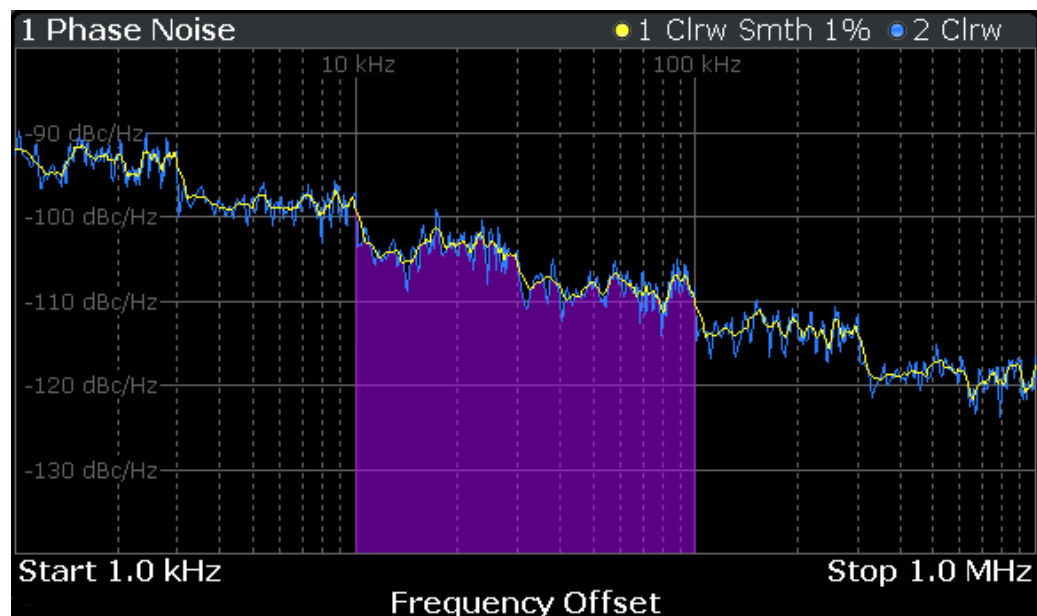

Figure 4-2: Residual noise based on an integration between 10 kHz and 100 kHz offset

4.3 Measurement range

Noise measurements determine the noise characteristics of a DUT over a particular measurement range. This **measurement range** is defined by two offset frequencies. The **frequency offsets** themselves are relative to the nominal frequency of the DUT.

The measurement range again is divided into several (logarithmic) decades, or, for configuration purposes, into **half decades**.

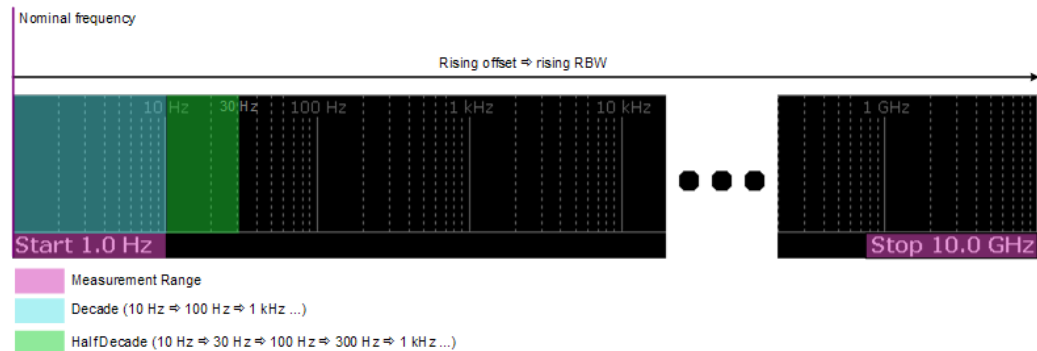

Figure 4-3: Measurement range and half decades

This breakdown into several half decades is made to speed up measurements. You can configure each half decade separately in the "Half Decade Configuration Table". For quick, standardized measurements, the application provides several predefined sweep types or allows you to configure each half decade manually, but globally.

The main issue in this context is the **resolution bandwidth (RBW)** and its effect on the measurement time. In general, it is best to use a resolution bandwidth as small as possible for the most accurate measurement results. However, accuracy comes at the price of measurement speed.

To avoid long measurement times, the application provides only a certain range of RBWs that are available for each half decade.

4.4 Sweep modes

Sweep modes define the data processing method.

Swept

The application performs a sweep of the frequency spectrum.

I/Q FFT

The application evaluates the I/Q data that has been collected and calculates the trace based on that data.

4.5 Trace averaging

The application provides several methods of trace averaging that you can use separately or in any combination.

The order in which averaging is performed is as follows.

1. Half decade averaging.
The application measures each half decade a particular number of times before measuring the next one.
2. Cross-correlation
The application performs a certain number of cross-correlation operations in each half decade.
3. Sweep count.
The application measures the complete measurement range a particular number of times.
It again includes half decade averaging as defined.
After the measurement over the sweep count is finished, the application displays the averaged results.
4. Trace smoothing.
Calculates the moving average for the current trace.

4.5.1 Half decade averaging

Define the number of measurements that the application performs for each half decade before it displays the averaged results and measures the next half decade.

In combination with the RBW, this is the main factor that affects the measurement time. Usually, a small number of averages is sufficient for small RBWs, because small RBWs already provide accurate results, and a high number of averages for high RBWs to get more balanced results.

4.5.2 Sweep count

The sweep count defines the number of sweeps that the application performs during a complete measurements.

A sweep in this context is the measurement over the complete measurement range once. A complete measurement, however, can consist of more than one sweep. In that case, the application measures until the number of sweeps that have been defined are done. The measurement configuration stays the same all the time.

In combination with the average trace mode and half decade averaging, the sweep count averages the trace even more.

4.5.3 Trace smoothing

(Software-based) **smoothing** is a way to remove anomalies visually in the trace that can distort the results. The smoothing process is based on a moving average over the complete measurement range. The number of samples included in the averaging process (the *aperture* size) is variable and is a percentage of all samples that the trace consists of.

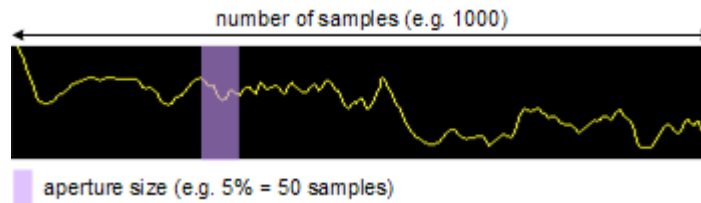

Figure 4-4: Sample size included in trace smoothing

The application smooths the trace only after the measurement has been finished and the data has been analyzed and written to a trace. Thus, smoothing is just an enhancement of the trace display, not of the data itself. This also means that smoothing is always applied after any other trace averagings have been done, as these happen during the measurement itself.

You can turn trace smoothing on and off for all traces individually and compare, for example, the raw and the smooth trace.

Linear smoothing is based on the following algorithm:

$$y'(s) = \frac{1}{n} \left(\sum_{x=s-\frac{n-1}{2}}^{x=s+\frac{n-1}{2}} y(x) \right)$$

Equation 4-1: Linear trace smoothing

Logarithmic smoothing is based on the following algorithm:

$$y'(s) = 10 \cdot \log_{10} \left(\frac{1}{n} \left(\sum_{x=s-\frac{n-1}{2}}^{x=s+\frac{n-1}{2}} 10^{\left(\frac{y(x)}{10} \right)} \right) \right)$$

Equation 4-2: Logarithmic trace smoothing

$y(s)$ = logarithmic phase noise level

4.6 Frequency determination

Nominal frequency

The nominal frequency is the output or center frequency of the DUT. To get correct and valid measurement results, the application needs to know the real frequency of the DUT.



Unverified signals

The R&S FPL1000 tries to start the measurement as soon as you enter the phase noise application. If it cannot verify a signal, it will try to start the measurement over and over.

To stop the repeated (and probably unsuccessful) signal verification, stop the measurement on the first verification failure.

The available (nominal) frequency range depends on the hardware you are using. For more information see the datasheet of the R&S FPL1000.

If you are not sure about the nominal frequency, define a tolerance range to verify the frequency. For measurements on unstable or drifting DUTs, use the frequency tracking functionality.

Frequency verification

When you are using frequency verification, the application initiates a measurement that verifies that the frequency of the DUT is within a certain range of the nominal frequency. This measurement takes place before the actual phase noise measurement. Its purpose is to find strong signals within a frequency tolerance range and, if successful, to adjust the nominal frequency and lock onto that new frequency. The frequency tolerance is variable. You can define it in absolute or relative terms.

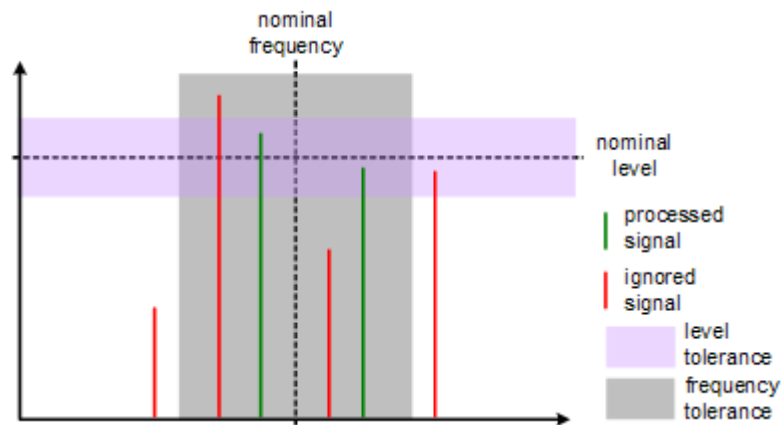

Figure 4-5: Frequency and level tolerance

You can define both absolute and relative tolerances. In that case, the application uses the higher tolerance to determine the frequency.

If there is no signal within the tolerance range, the application aborts the phase noise measurement.

In the numerical results, the application always shows the frequency the measurement was actually performed on. If the measured frequency is not the same as the nominal frequency, the numerical results also show the deviation from the nominal frequency.

Frequency tracking

When you are using the frequency tracking, the application tracks drifting frequencies of unstable DUTs. It internally adjusts and keeps a lock on the nominal frequency of the DUT.

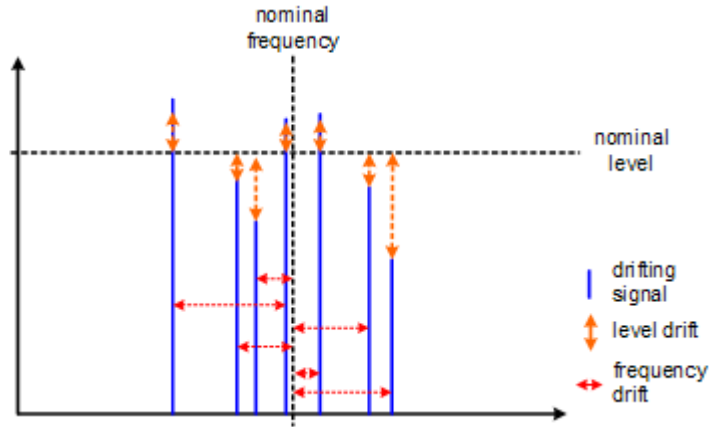

Figure 4-6: Frequency and level tracking

Tracking bandwidth

The tracking bandwidth defines the bandwidth within which the application tracks the frequency.

Normally, the application adjusts the sample rate to the half decade it is currently measuring. For half decades that are near the carrier, the sample rate is small. Half decades far from the carrier use a higher sample rate. However, in case of drifting signals, this method may result in data loss because the default bandwidth for a half decade might be too small for the actual drift in the frequency. In that case, you can define the tracking bandwidth which increases the sample rate if necessary and thus increases the chance to capture the signal.

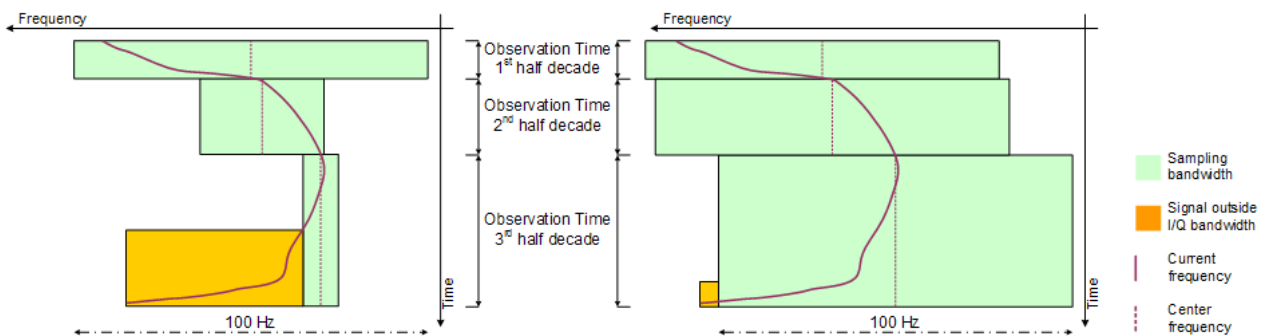

Figure 4-7: Frequency tracking with tracking bandwidth turned off (left) and a tracking bandwidth of 100 Hz (right)

4.7 Level determination

Nominal level

The nominal level in other terms is the reference level of the R&S FPL1000. This is the level that the analyzer expects at the RF input.

The available level range depends on the hardware. For more information see the datasheet of the R&S FPL1000.

Make sure to define a level that is as close to the level of the DUT to get the best dynamic range for the measurement. At the same time make sure that the signal level is not higher than the reference level to avoid an overload of the A/D converter and thus deteriorating measurement results.

If you are not sure about the power level of the DUT, but would still like to use the best dynamic range and get results that are as accurate as possible, you can verify or track the level.

Level verification

When you are using the level verification, the application initiates a measurement that determines the level of the DUT. If the level of the DUT is within a certain tolerance range, it will adjust the nominal level to that of the DUT. Else, it will abort the phase noise measurement.

Define a level tolerance in relation to the current nominal level. The tolerance range works for DUT levels that are above or below the current nominal level.

Level tracking

For tests on DUTs whose level varies, use level tracking. If active, the application keeps track of the DUTs level during the phase noise measurement and adjusts the nominal level accordingly.

For a graphical representation of level verification and level tracking see the figures in [Chapter 4.6, "Frequency determination"](#), on page 29.

4.8 Signal attenuation

Attenuation of the signal may become necessary if you have to reduce the power of the signal that you have applied. Power reduction is necessary, for example, to prevent an overload of the input mixer. An overload of the input mixer may lead to incorrect measurement results or damage to the hardware if the signal power is too strong.

In the default state, the application automatically determines the attenuation according to the reference level. If necessary, you can also define the attenuation manually.

When you attenuate the signal, the application adjusts graphical and numerical results accordingly.

Because the reference level and attenuation are interdependent, changing the attenuation manually may also adjust the reference level.

RF attenuation

RF attenuation is always available. It is a combination of mechanical and IF attenuation.

The mechanical attenuator is located directly after the RF input of the R&S FPL1000. Its step size is 5 dB. IF attenuation is applied after the signal has been down-converted. Its step size is 1 dB.

Thus, the step size for RF attenuation as a whole is 1 dB. Mechanical attenuation is used whenever possible (attenuation levels that are divisible by 5). IF attenuation handles the 1 dB steps only.

Example:

If you set an attenuation level of 18 dB, 15 dB are mechanical attenuation and 3 dB are IF attenuation.

If you set an attenuation level of 6 dB, 5 dB are mechanical attenuation and 1 dB is IF attenuation.

Electronic attenuation

Electronic attenuation is available with R&S FPL1000-B25. You can use it in addition to mechanical attenuation. The step size of electronic attenuation is 1 dB with attenuation levels not divisible by 5 again handled by the IF attenuator. Compared to RF attenuation, you can define the amount of mechanical and electronic attenuation freely.

4.9 Using limit lines

Limit lines provide an easy way to verify if measurement results are within the limits you need them to be. As soon as you turn a limit line on, the application will indicate if the phase noise a trace displays is in line with the limits or if it violates the limits.

The application provides two kinds of limit lines. 'Normal' limit lines as you know them from the Spectrum application and special thermal limit lines for easy verification of thermal noise results.

Phase noise limit lines

Phase noise limit lines have been designed specifically for phase noise measurements. Their shape is based on the thermal noise floor of the DUT and the typical run of the phase noise curve.

The typical slope of the phase noise curve depends on the offset from the DUT frequency. In the white noise range (the noise floor), far away from the carrier, the slope is more or less 0 dB per frequency decade. In the colored noise segment, the slope is greater than 0 dB. The slope, however, is not constant in that segment, but again is typical for various carrier offset segments (or ranges).

The application supports the definition of up to five ranges, each with a different slope. The ranges themselves are defined by corner frequencies. Corner frequencies are those frequencies that mark the boundaries of typical curve slopes. If you use all five ranges, the result would be a limit line with six segments.

All segments have a slope of 10 dB per decade (f^{-1}) by default.

In most cases, these special limit lines will suffice for phase noise measurements as they represent the typical shape of a phase noise curve.

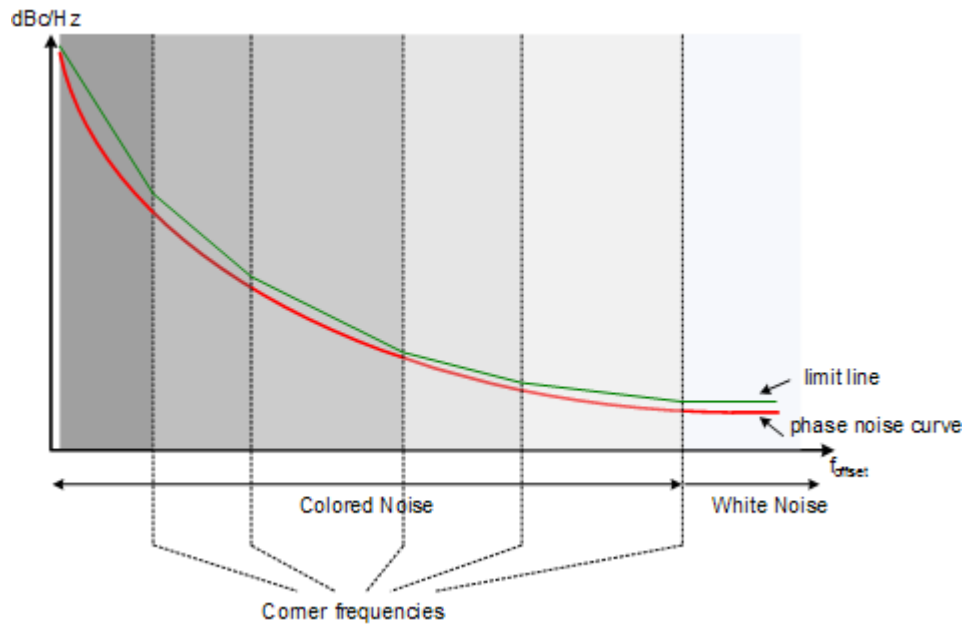

Figure 4-8: Typical looks of a special limit line

Normal limit lines

Normal limit lines on the other hand may have any shape and may consist of up to 200 data points. You can turn on up to 8 normal limit lines at the same time. Each of those limit lines can test one or several traces.

If you want to use them for phase noise measurements however, a limit line must be scaled in the unit dBc/Hz and must be defined on a logarithmic scale on the horizontal axis.

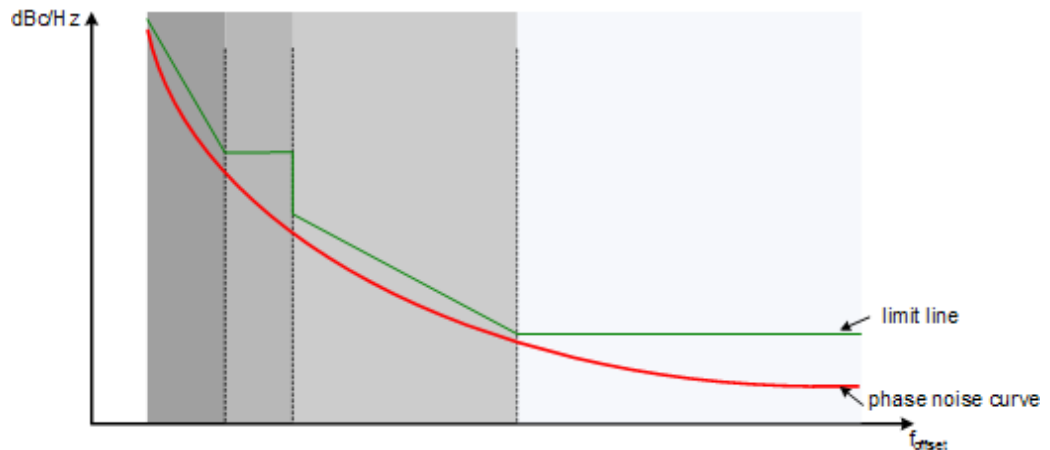

Figure 4-9: Possible looks of a normal limit line

4.10 Analyzing several traces - trace mode

If several sweeps are performed one after the other, or continuous sweeps are performed, the trace mode determines how the data for subsequent traces is processed. After each sweep, the trace mode determines whether:

- the data is frozen (View)
- the data is hidden (Blank)
- the data is replaced by new values (Clear Write)
- the data is replaced selectively (Max Hold, Min Hold, Average)



Each time the trace mode is changed, the selected trace memory is cleared.

The R&S FPL1000 provides the following trace modes:

Table 4-1: Overview of available trace modes

Trace Mode	Description
Blank	Hides the selected trace.
Clear Write	Overwrite mode: the trace is overwritten by each sweep. This is the default setting.
Max Hold	The maximum value is determined over several sweeps and displayed. The R&S FPL1000 saves the sweep result in the trace memory only if the new value is greater than the previous one.
Min Hold	The minimum value is determined from several measurements and displayed. The R&S FPL1000 saves the sweep result in the trace memory only if the new value is lower than the previous one.
Average	The average is formed over several sweeps. The sweep count determines the number of averaging procedures.
View	The current contents of the trace memory are frozen and displayed.



If a trace is frozen ("View" mode), the instrument settings, apart from level range and reference level, can be changed without impact on the displayed trace. The fact that the displayed trace no longer matches the current instrument setting is indicated by the  icon on the tab label.

If the level range or reference level is changed, the R&S FPL1000 automatically adapts the trace data to the changed display range. This allows an amplitude zoom to be made after the measurement in order to show details of the trace.

Trace averaging algorithm

In "Average" trace mode, the sweep count determines how many traces are averaged. The more traces are averaged, the smoother the trace is likely to become.

The algorithm for averaging traces depends on the sweep mode and sweep count.

- sweep count = 0 (default)
In continuous sweep mode, a continuous average is calculated for 10 sweeps, according to the following formula:

$$Trace = \frac{9 * Trace_{old} + MeasValue}{10}$$

Figure 4-10: Equation 1

Due to the weighting between the current trace and the average trace, past values have practically no influence on the displayed trace after about ten sweeps. With this setting, signal noise is effectively reduced without need for restarting the averaging process after a change of the signal.

- sweep count = 1
The currently measured trace is displayed and stored in the trace memory. No averaging is performed.
- sweep count > 1
For both "Single Sweep" mode and "Continuous Sweep" mode, averaging takes place over the selected number of sweeps. In this case the displayed trace is determined during averaging according to the following formula:

$$Trace_n = \frac{1}{n} \cdot \left[\sum_{i=1}^{n-1} (T_i) + MeasValue_n \right]$$

Figure 4-11: Equation 2

where n is the number of the current sweep (n = 2 ... Sweep Count).

No averaging is carried out for the first sweep but the measured value is stored in the trace memory. With increasing n, the displayed trace is increasingly smoothed since there are more individual sweeps for averaging.

After the selected number of sweeps the average trace is saved in the trace memory. Until this number of sweeps is reached, a preliminary average is displayed.

When the averaging length defined by the "Sweep Count" is attained, averaging is continued in continuous sweep mode or for "Continue Single Sweep" according to the following formula:

$$Trace = \frac{(N - 1) * Trace_{old} + MeasValue}{N}$$

where N is the sweep count

4.11 Using markers

Markers are used to mark points on traces, to read out measurement results and to select a display section quickly. The application provides 4 markers.

By default, the application positions the marker on the lowest level of the trace. You can change a marker position in several ways.

- Enter a particular offset frequency in the input field that opens when you activate a marker.
- Move the marker around with the rotary knob or the cursor keys.

4.11.1 Marker types

All markers can be used either as normal markers or delta markers. A normal marker indicates the absolute signal value at the defined position in the diagram. A delta marker indicates the value of the marker relative to the specified reference marker (by default marker 1).

In addition, special functions can be assigned to the individual markers. The availability of special marker functions depends on whether the measurement is performed in the frequency or time domain.

4.11.2 Activating markers

Only active markers are displayed in the diagram and in the marker table. Active markers are indicated by a highlighted softkey.

By default, marker 1 is active and positioned on the maximum value (peak) of trace 1 as a normal marker. If several traces are displayed, the marker is set to the maximum value of the trace which has the lowest number and is not frozen (View mode). The next marker to be activated is set to the frequency of the next lower level (next peak) as a delta marker; its value is indicated as an offset to marker 1.

A marker can only be activated when at least one trace in the corresponding window is visible. If a trace is switched off, the corresponding markers and marker functions are also deactivated. If the trace is switched on again, the markers along with coupled functions are restored to their original positions, provided the markers have not been used on another trace.

5 Configuration

Access: [MODE] > "Phase Noise"

When you activate a measurement channel in the Phase Noise application, a measurement for the input signal is started automatically with the default configuration. The "Phase Noise" menu is displayed and provides access to the most important configuration functions.

For a description see

- [Chapter 5.3, "Configuring the frontend"](#), on page 40
- [Chapter 5.4, "Controlling the measurement"](#), on page 42
- [Chapter 5.5, "Configuring the measurement range"](#), on page 45
- [Chapter 6.3, "Using limit lines"](#), on page 64
- [Chapter 6.1, "Configuring graphical result displays"](#), on page 54
- [Chapter 6.2, "Configure numerical result displays"](#), on page 62



Automatic refresh of preview and visualization in dialog boxes after configuration changes

The R&S FPL1000 supports you in finding the correct measurement settings quickly and easily - after each change in settings in dialog boxes, the preview and visualization areas are updated immediately and automatically to reflect the changes. Thus, you can see if the setting is appropriate or not before accepting the changes.

• Configuration overview	38
• Default settings for phase noise measurements	40
• Configuring the frontend	40
• Controlling the measurement	42
• Configuring the measurement range	45
• Performing measurements	49
• Configuring in- and outputs	51
• Automatic measurement configuration	52

5.1 Configuration overview



Throughout the measurement channel configuration, an overview of the most important currently defined settings is provided in the "Overview". The "Overview" is displayed when you select the "Overview" icon, which is available at the bottom of all softkey menus.

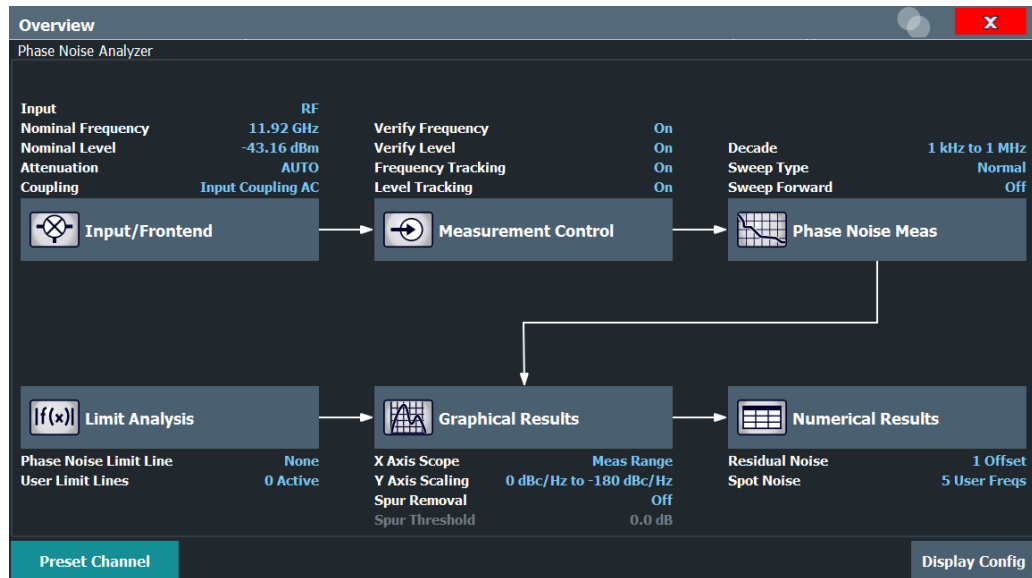

In addition to the main measurement settings, the "Overview" provides quick access to the main settings dialog boxes. The individual configuration steps are displayed in the order of the data flow. Thus, you can easily configure an entire measurement channel from input over processing to output and analysis by stepping through the dialog boxes as indicated in the "Overview".

In particular, the "Overview" provides quick access to the following configuration dialog boxes (listed in the recommended order of processing):

1. Frontend
See [Chapter 5.3, "Configuring the frontend"](#), on page 40.
2. Measurement Control
See [Chapter 5.4, "Controlling the measurement"](#), on page 42.
3. Phase Noise Measurement
See [Chapter 5.5, "Configuring the measurement range"](#), on page 45.
4. Limit Analysis
See [Chapter 6.3, "Using limit lines"](#), on page 64.
5. Graphical Results
See [Chapter 6.1, "Configuring graphical result displays"](#), on page 54.
6. Numerical Results
See [Chapter 6.2, "Configure numerical result displays"](#), on page 62.

To configure settings

- ▶ Select any button in the "Overview" to open the corresponding dialog box.
Select a setting in the channel bar (at the top of the measurement channel tab) to change a specific setting.

Preset Channel setup

Select the "Preset Channel" button in the lower left-hand corner of the "Overview" to restore all measurement settings *in the current channel setup* to their default values.

Note: Do not confuse the "Preset Channel" button with the [Preset] key, which restores the entire instrument to its default values and thus closes *all channel setups* on the R&S FPL1000 (except for the default channel setup)!

Remote command:

`SYSTem:PRESet:CHANnel [:EXEC]` on page 86

5.2 Default settings for phase noise measurements

When you enter the phase noise application for the first time, a set of parameters is passed on from the currently active application:

- nominal or center frequency
- nominal or reference level
- input coupling

After initial setup, the parameters for the measurement channel are stored upon exiting and restored upon re-entering the channel. Thus, you can switch between applications quickly and easily.

Apart from these settings, the following default settings are activated directly after a measurement channel has been set to the Phase Noise application, or after a channel preset:

Table 5-1: Default settings for phase noise measurement channels

Parameter	Value
Attenuation	Auto (0 dB)
Verify frequency & level	On
Frequency & level tracking	Off
Measurement range	1 kHz ... 1 MHz
Sweep type	Normal
X-axis scaling	Measurement range
Y-axis scaling	20 dBc/Hz ... 120 dBc/Hz
Smoothing	1%
Smoothing type	Linear

5.3 Configuring the frontend

Access: "Overview" > "Input / Frontend"

The "Frontend" tab of the "Measurement Settings" dialog box contains all functions necessary to configure the frontend of the RF measurement hardware.

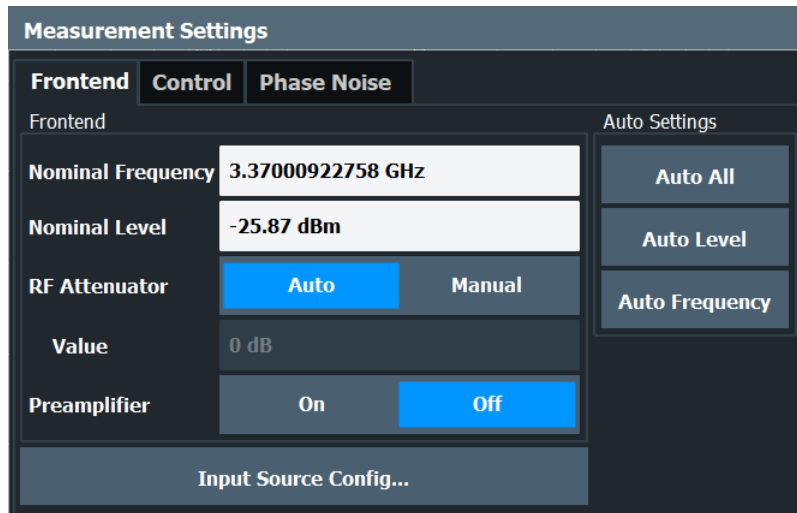

Functions to configure the RF input described elsewhere:

- [Chapter 5.7.1, "Input source configuration"](#), on page 51

Nominal Frequency	41
Nominal Level	41
Mechanical Attenuator / Value	41
Coupling	42

Nominal Frequency

Defines the nominal frequency of the measurement.

For more information see [Chapter 4.6, "Frequency determination"](#), on page 29.

Remote command:

[\[SENSe:\] FREQuency:CENTer](#) on page 98

Nominal Level

Defines the nominal level of the R&S FPL1000.

For more information see [Chapter 4.7, "Level determination"](#), on page 32

Remote command:

[\[SENSe:\] POWer:RLEVEL:VERify\[:STATE\]](#) on page 102

Mechanical Attenuator / Value

Turns mechanical attenuation on and off.

If on, you can define an attenuation level in 5 dB steps.

For more information see [Chapter 4.8, "Signal attenuation"](#), on page 32.

Remote command:

Turning manual attenuation on and off:

[INPut<ip>:ATTenuation:AUTO](#) on page 99

Defining an attenuation level:

[INPut<ip>:ATTenuation](#) on page 98

Coupling

Selects the coupling method at the RF input.

AC coupling blocks any DC voltage from the input signal. DC coupling lets DC voltage through.

For more information refer to the data sheet.

Remote command:

`INPut<ip>:COUPling` on page 153

5.4 Controlling the measurement

Access: "Overview" > "Measurement Control"

The "Control" tab of the "Measurement Settings" dialog box contains all functions necessary to control the sequence of the phase noise measurement.

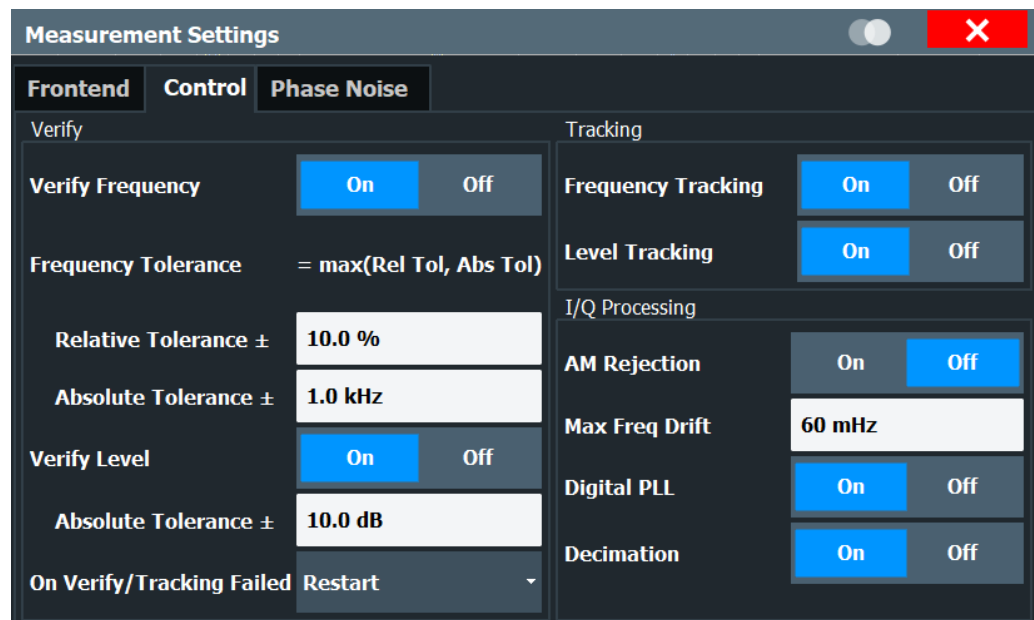

Verify Frequency.....	42
Verify Level.....	43
On Verify Failed.....	43
Frequency Tracking.....	43
Level Tracking.....	44
AM Rejection.....	44
Max Freq Drift.....	44
Digital PLL.....	44
Decimation.....	44
Online I/Q.....	45

Verify Frequency

Turns frequency verification on and off.

If frequency verification is on, the R&S FPL1000 initiates the phase noise measurement only if the frequency of the DUT is within a certain frequency tolerance range. The tolerance range is either a percentage range of the nominal frequency or an absolute deviation from the nominal frequency.

If you define both an absolute and relative tolerance, the application uses the higher tolerance level.

For more information see [Chapter 4.6, "Frequency determination"](#), on page 29.

Remote command:

Verify frequency:

`[SENSe:]FREQuency:VERify[:STATe]` on page 100

Relative tolerance:

`[SENSe:]FREQuency:VERify:TOLerance[:RELative]` on page 100

Absolute tolerance:

`[SENSe:]FREQuency:VERify:TOLerance:ABSolute` on page 100

Verify Level

Turns level verification on and off.

If level verification is on, the R&S FPL1000 initiates the phase noise measurement only if the level of the DUT is within a certain level tolerance range. The tolerance range is a level range relative to the nominal level.

For more information see [Chapter 4.7, "Level determination"](#), on page 32.

Remote command:

Verify level:

`[SENSe:]POWER:RLEVEL:VERify[:STATe]` on page 102

Level tolerance:

`[SENSe:]POWER:RLEVEL:VERify:TOLerance` on page 102

On Verify Failed

Selects the way the application reacts if signal verification fails.

Takes effect on both frequency and level verification.

"Restart"	Restarts the measurement if verification has failed.
"Stop"	Stops the measurement if verification has failed.
"Run Auto All"	Starts an automatic frequency and level detection routine if verification has failed. After the new frequency and level have been set, the measurement restarts. For more information see Chapter 5.8, "Automatic measurement configuration" , on page 52.

Remote command:

`[SENSe:]SWEep:SVFailed` on page 103

Frequency Tracking

Turns frequency tracking on and off.

If on, the application tracks the frequency of the DUT during the phase noise measurement and adjusts the nominal frequency accordingly. The application adjusts the frequency after each half decade measurement.

For more information see [Chapter 4.6, "Frequency determination"](#), on page 29.

Remote command:

[\[SENSe:\] FREQuency:TRACk](#) on page 100

Level Tracking

Turns level tracking on and off.

If on, the R&S FPL1000 tracks the level of the DUT during phase noise measurements and adjusts the nominal level accordingly. The application adjusts the level after each half decade measurement.

For more information see [Chapter 4.7, "Level determination"](#), on page 32.

Remote command:

[\[SENSe:\] POWer:RLEVel:VERify\[:STATe\]](#) on page 102

AM Rejection

Turns the suppression of AM noise on and off.

If on, the application suppresses the AM noise that the signal contains in order to display phase noise as pure as possible.

AM rejection is available for the I/Q sweep mode.

Remote command:

[\[SENSe:\] REJect:AM](#) on page 103

Max Freq Drift

Defines the minimum bandwidth or sample rate used in the signal processing to increase the probability of capture drifting signals.

The tracking bandwidth is valid for all half decades measured in I/Q mode.

Remote command:

[\[SENSe:\] IQ:TBW](#) on page 102

Digital PLL

Turns an additional frequency correction based on the I/Q data on and off.

If on, the application is able to track frequency changes during the I/Q data capture that would otherwise fall into the half decade measurement bandwidth (see [Max Freq Drift](#)).

The digital PLL works for all half decades measured in I/Q mode.

Remote command:

[\[SENSe:\] IQ:DPLL](#) on page 101

Decimation

Turns decimation on and off.

When you turn on decimation, the samples that have already been used for a given half decade are resampled in lower half decades. Reusing these samples results in lower measurement times in the lower half decades, because less samples have to be recorded there.

To get valid results for lower offset frequencies, make sure to use an appropriate sample rate.

This feature is especially useful when you are measuring half decades with very low offset frequencies.

Using decimation is available for the "I/Q FFT" sweep mode.

Remote command:

[\[SENSe:\]IQ:DECimation](#) on page 101

Online I/Q

Turns the online measurement mode for I/Q measurements on and off.

When you turn the online measurement mode on, the application records smaller amounts of data at a time. It is thus able to process that data faster, because it does not have to wait until the I/Q capture buffer is full, before processing the data.. The result is that the measurement results are updated faster.

This mode is useful to measure the phase noise at small offset frequencies, because the small bandwidths required to measure these offset frequencies usually lead to long measurement times (and especially when you apply averaging).

In the Half Decade Configuration Table, half decades that are measured in online mode are highlighted in a darker shade of green (compared to the shade of green that is used to highlight the half decades that are taken into account in the measurement).

10 kHz	30 kHz	300 Hz	10	I/Q FFT	Blackman-Harris	< 0.1 s
30 kHz	100 kHz	1 kHz	10	I/Q FFT	Blackman-Harris	< 0.1 s

Light green = normal I/Q mode

Dark green = online I/Q mode

The online measurement mode is available under the following conditions:

- Only half decades with a frequency offset smaller than 30 kHz can be measured in online mode.
- The half decades that you want to measure in online mode have to be set to "I/Q FFT" sweep mode.
- [Decimation](#) has to be turned on.
- [Sweep Forward](#) has to be turned off.

Remote command:

[\[SENSe:\]IQ:ONLine](#) on page 101

5.5 Configuring the measurement range

Access: "Overview" > "Phase Noise Meas"

The "Phase Noise" tab of the "Measurement Settings" dialog box contains all functions necessary to configure the measurement range for phase noise measurements, including individual range settings.

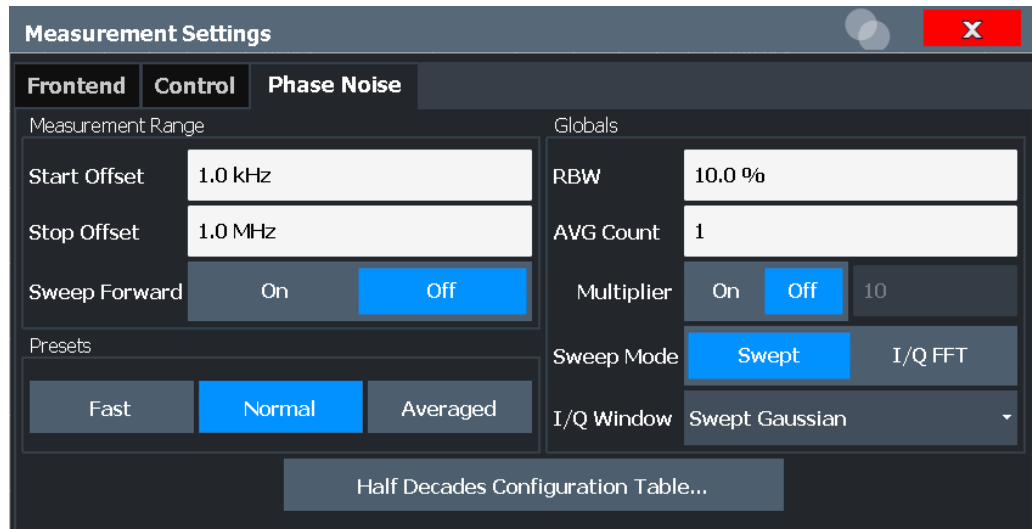

Range Start / Stop.....	46
Sweep Forward.....	46
Presets.....	47
Global RBW.....	47
Global Average Count.....	47
Multiplier.....	47
Global Sweep Mode.....	48
Global I/Q Window.....	48
Half Decades Configuration Table.....	48

Range Start / Stop

Defines the frequency offsets that make up the measurement range.

Note that the maximum offset you can select depends on the hardware you are using.

If a preamplifier is used, make sure the entire frequency range is covered by the pre-amplifier.

Remote command:

Measurement Range Start

[SENSe:] FREQuency: START on page 105

Measurement Range Stop

[SENSe:] FREQuency: STOP on page 105

Sweep Forward

Selects the sweep direction. Forward and reverse sweep direction are available.

Forward sweep direction performs a measurement that begins at the smallest frequency offset you have defined. The measurement ends after the largest offset has been reached.

Reverse sweep direction performs a measurement that begins at the largest frequency offset you have defined. The measurement ends after the smallest offset has been reached. The reverse sweep is the default sweep direction because the application is able to lock on a drifting carrier frequency in that case.

Remote command:

[SENSe:] SWEep:FORWARD on page 108

Presets

Selects predefined measurement settings for each individual half decade that are used for the measurement.

If the measurement settings differ from one of the preset states, the application displays a symbol (✱) at the label.

"Fast"	Fast measurements perform one measurement in each half decade. No averaging takes place.
"Normal"	Normal measurements use averaging for some half decades, but with respect to measurement speed.
"Average"	Average measurements use averaging for all half decades. However, you have to put up with slower measurement speed.

Remote command:

[SENSe:] SWEep:MODE on page 109

Global RBW

Defines the resolution bandwidth for all half decades globally.

The resulting RBW is a percentage of the start frequency of the corresponding half decade.

If the resulting RBW is not available, the application rounds to the next available bandwidth.

You can also change the global bandwidth with the "RBW Global" softkey in the "Bandwidth" menu.

Remote command:

[SENSe:] LIST:RANGe<range>:BWIDth[:RESolution] on page 106

Global Average Count

Defines the number of measurements that the application uses to calculate averaged results in each half decade.

The range is 1 to 10000.

Remote command:

[SENSe:] LIST:SWEep:COUNT on page 107

Multiplier

Turns a multiplier that changes the average count in each half decade on and off.

If on, you can define a value that multiplies the number of averages currently defined for each half decade by that value.

When you turn it off, the original averages are restored and used again.

Example:

You have three half decades:

- 1st half decade average count: 1
- 2nd half decade average count: 3
- 3rd half decade average count: 5

If you turn the multiplier on and define a value of 5, the average count changes as follows:

- 1st half decade average count: 5
- 2nd half decade average count: 15
- 3rd half decade average count: 25

Remote command:

[\[SENSe:\]LIST:SWEep:COUNT:MULTIplier](#) on page 108

[\[SENSe:\]LIST:SWEep:COUNT:MULTIplier:STATE](#) on page 108

Global Sweep Mode

Selects the analysis mode for all half decades. The sweep mode defines the way the application processes the data.

For more information see [Chapter 4.4, "Sweep modes"](#), on page 27.

"Normal" Uses spectrum analyzer data for the data analysis.

"I/Q / FFT" Uses I/Q data for the data analysis.

Remote command:

[\[SENSe:\]LIST:BWIDth\[:RESolution\]:TYPE](#) on page 105

Global I/Q Window

Selects the window function for all half decades.

The window function is available for I/Q analysis.

"Blackman Harris" Blackman Harris window.

"Chebychev" Chebychev window.

"Gaussian" Gaussian window.

"Rectangular" Rectangular window.

Remote command:

[\[SENSe:\]LIST:RANGe<range>:IQWindow:TYPE](#) on page 107

Half Decades Configuration Table

Contains all functionality to configure the phase noise measurement range.

"Start" Shows the offset frequency that the half decade starts with.

"Stop" Shows the offset frequency that the half decade stops with.

Tip: Note that double-clicking on one of the start or stop offset values is an easy way to adjust the measurement range.

"RBW" Selects resolution bandwidth for the half decade.

To avoid invalid measurements and long measurement times, the availability of RBW for each half decade is limited.

"Sweep Mode"	Selects the measurement mode. The measurement mode is the way the application analyzes the data. <ul style="list-style-type: none"> • Swept • I/Q / FFT For more information see Chapter 4.4, "Sweep modes" , on page 27.
"AVG"	Defines the number of averagings that the application performs before the results for a half decade are displayed.
"Window"	Selects the window type for a half decade. Window functions are available for I/Q measurements.
"Meas Time"	Shows an estimation of how long the measurement of a half decade lasts.

Remote command:

RBW:

[\[SENSe:\]LIST:RANGe<range>:BWIDth\[:RESolution\]](#) on page 106

Sweep Mode

[\[SENSe:\]LIST:RANGe<range>:FILTer:TYPE](#) on page 106

Averages:

[\[SENSe:\]LIST:RANGe<range>:SWEep:COUNT](#) on page 107

Window:

[\[SENSe:\]LIST:RANGe<range>:IQWindow:TYPE](#) on page 107

5.6 Performing measurements

Access: [SWEEP]

The "Sweep" menu contains all functionality necessary to control and perform phase noise measurements.

Functions to configure the sweep described elsewhere:

- ["Multiplier"](#) on page 47
- ["Global Average Count"](#) on page 47

Continuous Sweep / Run Cont	49
Single Sweep / Run Single	50
Continue Single Sweep	50
This is Sweep/Average Count ok?	50
Finish Half Decade	51

Continuous Sweep / Run Cont

After triggering, starts the measurement and repeats it continuously until stopped.

While the measurement is running, the "Continuous Sweep" softkey and the [RUN CONT] key are highlighted. The running measurement can be aborted by selecting the highlighted softkey or key again. The results are not deleted until a new measurement is started.

Note: Sequencer. If the Sequencer is active, the "Continuous Sweep" softkey only controls the sweep mode for the currently selected channel setup. However, the sweep

mode only takes effect the next time the Sequencer activates that channel setup, and only for a channel-defined sequence. In this case, a channel setup in continuous sweep mode is swept repeatedly.

Furthermore, the [RUN CONT] key controls the Sequencer, not individual sweeps. [RUN CONT] starts the Sequencer in continuous mode.

For details on the Sequencer, see the R&S FPL1000 User Manual.

Remote command:

`INITiate<n>:CONTInuous` on page 87

Single Sweep / Run Single

While the measurement is running, the "Single Sweep" softkey and the [RUN SINGLE] key are highlighted. The running measurement can be aborted by selecting the highlighted softkey or key again.

Note: Sequencer. If the Sequencer is active, the "Single Sweep" softkey only controls the sweep mode for the currently selected channel setup. However, the sweep mode only takes effect the next time the Sequencer activates that channel setup, and only for a channel-defined sequence. In this case, the Sequencer sweeps a channel setup in single sweep mode only once.

Furthermore, the [RUN SINGLE] key controls the Sequencer, not individual sweeps. [RUN SINGLE] starts the Sequencer in single mode.

If the Sequencer is off, only the evaluation for the currently displayed channel setup is updated.

For details on the Sequencer, see the R&S FPL1000 User Manual.

Remote command:

`INITiate<n>[:IMMEDIATE]` on page 88

Continue Single Sweep

After triggering, repeats the number of sweeps set in "Sweep Count", without deleting the trace of the last measurement.

While the measurement is running, the "Continue Single Sweep" softkey and the [RUN SINGLE] key are highlighted. The running measurement can be aborted by selecting the highlighted softkey or key again.

Remote command:

`INITiate<n>:CONMeas` on page 87

This is Sweep/Average Count ok?

Defines the number of sweeps to be performed in the single sweep mode. Values from 0 to 200000 are allowed. If the values 0 or 1 are set, one sweep is performed.

The sweep count is applied to all the traces in all diagrams.

If the trace modes "Average", "Max Hold" or "Min Hold" are set, this value also determines the number of averaging or maximum search procedures.

In continuous sweep mode, if "Sweep Count" = 0 (default), averaging is performed over 10 sweeps. For "Sweep Count" = 1, no averaging, maxhold or minhold operations are performed.

Remote command:

`[SENSe:]SWEep:COUNT` on page 109

Finish Half Decade

Aborts the measurement in the current half decade and continues measuring the subsequent half decade.

Averaged results displayed for a half decade finished prematurely are based on the number of measurements already done.

Remote command:

[SENSe:] SWEep:FHDecade on page 89

5.7 Configuring in- and outputs

The "In- / Output" menu contains all functionality necessary to control and perform phase noise measurements.

- [Input source configuration](#).....51
- [Independent CW source settings](#).....51

5.7.1 Input source configuration

Access: "Overview" > "Input / Frontend" > "Input Source Config"

The "Radio Frequency" dialog box contains functionality to configure the input source.

Note that the "Radio Frequency (On Off)" button is unavailable in the R&S FPL1000-K40

[Coupling](#).....51

Coupling

Selects the coupling method at the RF input.

AC coupling blocks any DC voltage from the input signal. DC coupling lets DC voltage through.

For more information refer to the data sheet.

Remote command:

INPut<ip>:COUPling on page 153

5.7.2 Independent CW source settings

Access: Toolbar > "Generator Config"

The independent CW signal is available in all R&S FPL1000 applications if the optional Internal Generator R&S FPL1-B9 is installed.

For details, see the R&S FPL1000 User Manual.

[State](#).....52

[Level](#).....52

[Level Offset](#).....52

[CW Frequency](#).....52

State

Enables or disables the internal generator. The generator signal is output at the GEN Output 50 Ω connector on the front panel.

Remote command:

`OUTPut<up>[:STATe]` on page 155

Level

Defines the output power of the internal generator.

The default output power is -20 dBm. The range is from -60 dBm to +10 dBm.

Remote command:

`SOURce<si>:POWer[:LEVel][:IMMediate][:AMPLitude]` on page 155

Level Offset

Defines an offset to the output power of the internal generator.

Used to adapt the level display, for example to cable loss.

Remote command:

`SOURce<si>:POWer[:LEVel][:IMMediate]:OFFSet` on page 156

CW Frequency

Defines the frequency of the independent CW source. The step size depends on the measurement mode.

If the internal generator is used as a tracking generator, the frequency is coupled to the frequency of the analyzer. Thus, this setting is not available.

Remote command:

`SOURce<si>:INTernal:FREQuency` on page 155

5.8 Automatic measurement configuration

Access: [AUTO SET]

The "Auto Set" menu contains all functionality necessary to determine measurement parameters automatically.

Adjusting all Determinable Settings Automatically (Auto All)	52
Adjusting the Center Frequency Automatically (Auto Frequency)	53
Setting the Reference Level Automatically (Auto Level)	53

Adjusting all Determinable Settings Automatically (Auto All)

Activates all automatic adjustment functions for the current measurement settings, including:

- [Auto Frequency](#)
- [Auto Level](#)

Remote command:

`[SENSe:]ADJust:ALL` on page 156

Adjusting the Center Frequency Automatically (Auto Frequency)

The R&S FPL1000 adjusts the center frequency automatically.

The optimum center frequency is the frequency with the highest S/N ratio in the frequency span. As this function uses the signal counter, it is intended for use with sinusoidal signals.

To set the optimal reference level, see "[Setting the Reference Level Automatically \(Auto Level\)](#)" on page 53).

Remote command:

`[SENSe:]ADJust:FREQuency` on page 156

Setting the Reference Level Automatically (Auto Level)

Automatically determines a reference level which ensures that no overload occurs at the R&S FPL1000 for the current input data. At the same time, the internal attenuators are adjusted. As a result, the signal-to-noise ratio is optimized, while signal compression and clipping are minimized.

To determine the required reference level, a level measurement is performed on the R&S FPL1000.

If necessary, you can optimize the reference level further. Decrease the attenuation level manually to the lowest possible value before an overload occurs, then decrease the reference level in the same way.

Remote command:

`[SENSe:]ADJust:LEVel` on page 157

6 Analysis

The application provides various means and methods to analyze and evaluate measurement results.

- [Configuring graphical result displays](#)..... 54
- [Configure numerical result displays](#)..... 62
- [Using limit lines](#)..... 64
- [Using markers](#)..... 71

6.1 Configuring graphical result displays

Access: "Overview" > "Graphical Results"

The "Graphical" tab of the "Results" dialog box and the "Trace" menu contains all functions necessary to set up and configure the graphical phase noise result displays.

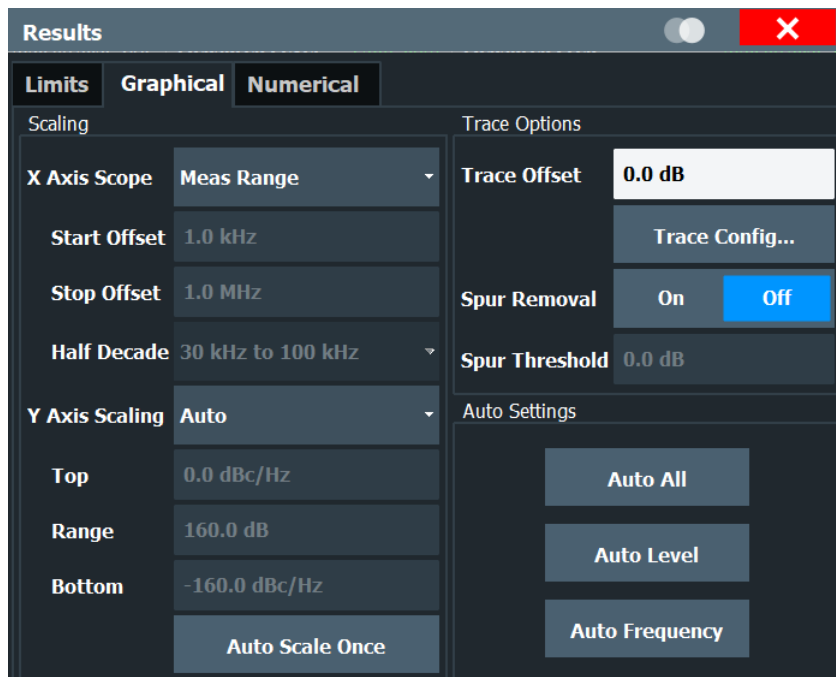

- [Scaling the diagram](#)..... 54
- [Configuring traces](#)..... 56
- [Trace/data ex/import](#)..... 58
- [Trace math](#)..... 61

6.1.1 Scaling the diagram

- [X-Axis Scope](#)..... 55
- [X-Axis Start / Stop](#)..... 55
- [Half Decade](#)..... 55

Y Axis Scaling.....	55
Top / Range / Bottom.....	56
Auto Scale Once.....	56

X-Axis Scope

Selects the way the application scales the horizontal axis.

"Half Decade" The horizontal axis shows one half decade that you can select.

"Manual" The horizontal axis shows a detail of the measurement range that you can define freely.

"Meas Range" The horizontal axis shows the complete measurement range.

Remote command:

[DISPlay\[:WINDow<n>\]:TRACe<t>:X\[:SCALe\]:SCOPE](#) on page 125

X-Axis Start / Stop

Defines the start and stop frequency of the horizontal axis.

Note that the displayed frequency range is a detail of the measurement range. Regardless of the displayed frequency range, the application still performs all measurement over the measurement range you have defined.

The range depends on the measurement range. and possible increments correspond to the half decades.

Available for a manual "X Axis Scope".

Remote command:

X-axis start:

[DISPlay\[:WINDow<n>\]:TRACe<t>:X\[:SCALe\]:START](#) on page 126

X-axis stop:

[DISPlay\[:WINDow<n>\]:TRACe<t>:X\[:SCALe\]:STOP](#) on page 126

Half Decade

Selects the half decade that is displayed.

Available if you have selected the half decade "X Axis Scope".

Remote command:

[DISPlay\[:WINDow<n>\]:TRACe<t>:X\[:SCALe\]:HDECade](#) on page 125

Y Axis Scaling

Selects the type of scaling for the vertical axis.

"Auto" Automatically scales the vertical axis.

"Top & Bottom" Allows you to set the values at the top and bottom of the vertical axis.

"Top & Range" Allows to set the value at the top of the vertical axis and its range.

"Bottom & Range" Allows you to set the value at the bottom of the vertical axis and its range.

Remote command:

Automatic scaling:

[DISPlay\[:WINDow<n>\]:TRACe<t>:Y\[:SCALe\]:AUTO](#) on page 127

Manual scaling:

[DISPlay\[:WINDow<n>\]:TRACe<t>:Y\[:SCALe\]:MANual](#) on page 127

Top / Range / Bottom

Define the top and bottom values or the range of the vertical axis.

Top defines the top values of the vertical axis. The unit is dBm/Hz.

Bottom defines the bottom value of the vertical axis. The unit is dBm/Hz.

Range defines the range of the vertical axis. The unit is dB.

The availability of the three fields depends on the type of manual "Y Axis Scaling" you have selected.

Remote command:

Top:

`DISPlay[:WINDow<n>]:TRACe<t>:Y[:SCALe]:RLEVel` on page 128

Range:

`DISPlay[:WINDow<n>]:TRACe<t>:Y[:SCALe]` on page 126

Bottom:

`DISPlay[:WINDow<n>]:TRACe<t>:Y[:SCALe]:RLEVel:LOWer` on page 128

Auto Scale Once

Automatically scales the vertical axis for ideal viewing.

6.1.2 Configuring traces

Trace Offset.....	56
Trace 1/Trace 2/Trace 3/Trace 4/Trace 5/Trace 6.....	56
Trace Mode.....	57
Smoothing.....	57
Spur Removal / Spur Threshold.....	57
Predefined Trace Settings - Quick Config.....	58
Spectrum Monitor: Raw Trace / Trk Trace (On Off).....	58
Copy Trace.....	58

Trace Offset

Access: "Overview" > "Graphical Results" > "Graphical" tab

Defines a trace offset in dB.

The trace offset moves the trace vertically by the level you have defined.

The range is from -200 dB to 200 dB.

Remote command:

`DISPlay[:WINDow<n>]:TRACe<t>:Y[:SCALe]:RLEVel:OFFSet` on page 129

Trace 1/Trace 2/Trace 3/Trace 4/Trace 5/Trace 6

Selects the corresponding trace for configuration. The currently selected trace is highlighted.

Remote command:

Selected via numeric suffix of: `TRACe<1...6>` commands

`DISPlay[:WINDow<n>][:SUBWindow<w>]:TRACe<t>[:STATE]` on page 124

Trace Mode

Defines the update mode for subsequent traces.

"Clear/ Write"	Overwrite mode (default): the trace is overwritten by each sweep. All available detectors can be selected.
"Max Hold"	The maximum value is determined over several measurements and displayed. The R&S FPL1000 saves the sweep result in the trace memory only if the new value is greater than the previous one.
"Min Hold"	The minimum value is determined from several measurements and displayed. The R&S FPL1000 saves the sweep result in the trace memory only if the new value is lower than the previous one.
"Average"	The average is formed over several sweeps.
"View"	The current contents of the trace memory are frozen and displayed. Note: If a trace is frozen, you can change the measurement settings, apart from scaling settings, without impact on the displayed trace. The fact that the displayed trace no longer matches the current measurement settings is indicated by a yellow asterisk * on the tab label. If you change any parameters that affect the scaling of the diagram axes, the R&S FPL1000 automatically adapts the trace data to the changed display range. Thus, you can zoom into the diagram after the measurement to show details of the trace.
"Blank"	Removes the selected trace from the display.

Remote command:

`DISPlay[:WINDow<n>][:SUBWindow<w>]:TRACe<t>:MODE` on page 122

Smoothing

If enabled, the trace is smoothed by the specified value (between 1 % and 50 %). The smoothing value is defined as a percentage of the display width. The larger the smoothing value, the greater the smoothing effect.

Remote command:

`DISPlay[:WINDow<n>][:SUBWindow<w>]:TRACe<t>:SMOothing[:STATe]`
on page 123

`DISPlay[:WINDow<n>][:SUBWindow<w>]:TRACe<t>:SMOothing:APERture`
on page 122

Spur Removal / Spur Threshold

Turns spur removal for all traces on and off and defines the threshold for spur removal.

For more information see [Chapter 4.1, "Spurs and spur removal"](#), on page 24.

Note that you can also remove spurs for individual traces in the "Trace Config" dialog box.

Remote command:

Turn spur suppression on and off:

`[SENSe:]SPURs:SUPPpress` on page 131

Set the threshold:

`[SENSe:]SPURs:THReshold` on page 132

Predefined Trace Settings - Quick Config

Commonly required trace settings have been predefined and can be applied very quickly by selecting the appropriate button.

Function	Trace Settings	
Preset All Traces	Trace 1:	Clear Write
		Blank
Set Trace Mode Max Avg Min	Trace 1:	Max Hold
	Trace 2:	Average
	Trace 3:	Min Hold
		Blank
Set Trace Mode Max ClrWrite Min	Trace 1:	Max Hold
	Trace 2:	Clear Write
	Trace 3:	Min Hold
		Blank

Spectrum Monitor: Raw Trace / Trk Trace (On Off)

Access: [TRACE] key for selected Spectrum Monitor window

Turns the traces displayed in the Spectrum Monitor result display on and off.

The "Raw Trace (On Off)" softkey controls the yellow trace.

The "Trk Trace (On Off)" softkey controls the blue trace.

Copy Trace

Access: "Overview" > "Analysis" > "Traces" > "Copy Trace"

Or: [TRACE] > "Copy Trace"

Copies trace data to another trace.

The first group of buttons (labeled "Trace 1" to "Trace 6") selects the source trace. The second group of buttons (labeled "Copy to Trace 1" to "Copy to Trace 6") selects the destination.

Remote command:

[TRACe<n>:COPY](#) on page 132

6.1.3 Trace/data ex/import

Access: [TRACE] > "Trace Config" > "Trace / Data Export"

The R&S FPL1000 provides various evaluation methods for the results of the performed measurements. However, you may want to evaluate the data with other, external applications. In this case, you can export the measurement data to a standard ASCII format file (DAT or CSV). You can also import existing trace data from a file, for example as a reference trace (Spectrum application only).



The standard data management functions (e.g. saving or loading instrument settings) that are available for all R&S FPL1000 applications are not described here.

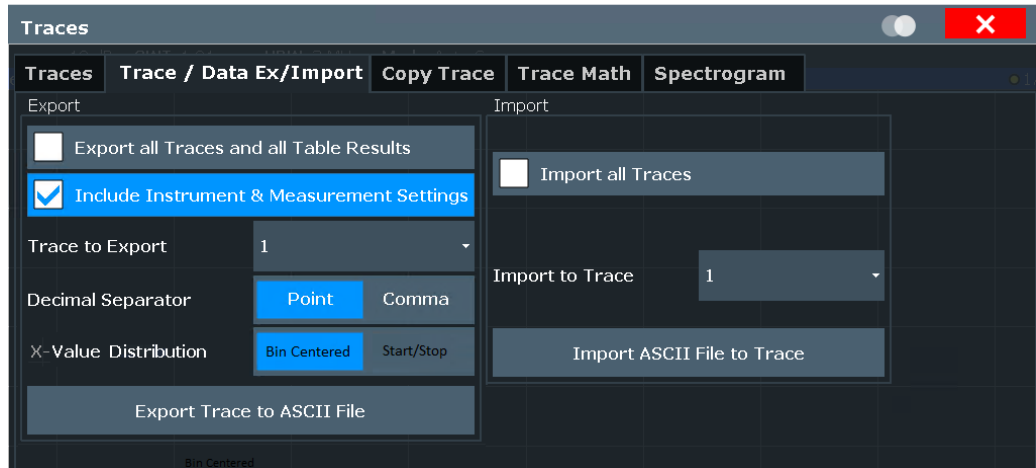

Export all Traces and all Table Results..... 59
 Include Instrument & Measurement Settings..... 59
 Trace to Export..... 59
 Decimal Separator..... 60
 X-Value Distribution..... 60
 Export Trace to ASCII File..... 60
 Importing Traces..... 60
 L Import All Traces/Import to Trace..... 60
 L Import ASCII File to Trace..... 60
 L File Explorer..... 61

Export all Traces and all Table Results

Selects all displayed traces and result tables (e.g. "Result Summary", marker table etc.) in the current application for export to an ASCII file.

Alternatively, you can select one specific trace only for export (see [Trace to Export](#)).

The results are output in the same order as they are displayed on the screen: window by window, trace by trace, and table row by table row.

Remote command:

[FORMat:DEXPort:TRACes](#) on page 130

Include Instrument & Measurement Settings

Includes additional instrument and measurement settings in the header of the export file for result data.

Remote command:

[FORMat:DEXPort:HEADer](#) on page 129

Trace to Export

Defines an individual trace to be exported to a file.

This setting is not available if [Export all Traces and all Table Results](#) is selected.

Decimal Separator

Defines the decimal separator for floating-point numerals for the data export/import files. Evaluation programs require different separators in different languages.

Remote command:

[FORMat:DEXPort:DSEParator](#) on page 129

X-Value Distribution

Defines how the x-values of the trace are determined in the frequency domain.

"Bin-Centered" The full measurement span is divided by the number of sweep points to obtain *bins*. The x-value of the sweep point is defined as the x-value at the center of the bin ($\text{bin}/2$).

"Start/Stop" (Default): The x-value of the first sweep point corresponds to the starting point of the full measurement span. The x-value of the last sweep point corresponds to the end point of the full measurement span. All other sweep points are divided evenly between the first and last points.

Remote command:

[FORMat:DEXPort:XDIStrib](#) on page 130

Export Trace to ASCII File

Opens a file selection dialog box and saves the selected trace in ASCII format (`.dat`) to the specified file and directory.

The results are output in the same order as they are displayed on the screen: window by window, trace by trace, and table row by table row.

Remote command:

[MMEMory:STORe<n>:TRACe](#) on page 131

Importing Traces

Trace data that was stored during a previous measurement can be imported to the Spectrum application, for example as a reference trace.

Import All Traces/Import to Trace ← Importing Traces

If the import file contains more than one trace, you can import several traces at once, overwriting the existing trace data for any active trace in the result display with the same trace number. Data from the import file for currently not active traces is not imported.

Alternatively, you can import a single trace only, which is displayed for the trace number specified in "Import to Trace". This list contains all currently active traces in the result display. If a trace with the specified number exists in the import file, that trace is imported. Otherwise, the first trace in the file is imported (indicated by a message in the status bar).

Remote command:

[FORMat:DIMPort:TRACes](#) on page 130

Import ASCII File to Trace ← Importing Traces

Loads one trace or all traces from the selected file in the selected ASCII format (`.DAT` or `.CSV`) to the currently active result display.

Remote command:

[FORMat:DImport:TRACes](#) on page 130

File Explorer ← Import ASCII File to Trace ← Importing Traces

Opens the Microsoft Windows File Explorer.

Remote command:

not supported

6.1.4 Trace math

Access: [TRACE] > "Trace Math"

If you have several traces with different modes, for example an average trace and a maximum trace, it may be of interest to compare the results of both traces. In this example, you could analyze the maximum difference between the average and maximum values. To analyze the span of result values, you could subtract the minimum trace from the maximum trace. For such tasks, the results from several traces can be combined using mathematical functions.

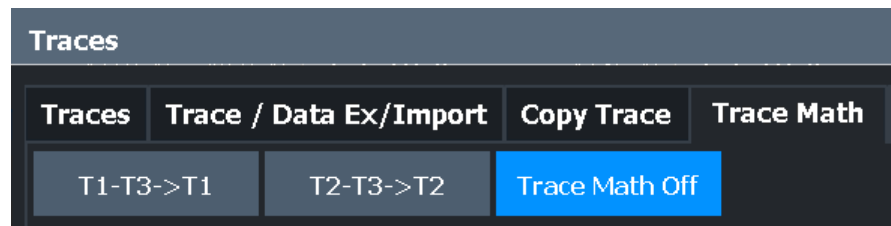

Trace Math Function	61
Trace Math Off	61

Trace Math Function

Defines which trace is subtracted from trace 1. The result is displayed in trace 1.

"T1-T3->T1"	Subtracts trace 3 from trace 1
T2-T3->T2	Subtracts trace 3 from trace 2

To switch off the trace math, use the [Trace Math Off](#) button.

Remote command:

[CALCulate<n>:MATH<t>\[:EXPRession\] \[:DEFine\]](#) on page 121

[CALCulate<n>:MATH<t>:STATe](#) on page 122

Trace Math Off

Deactivates any previously selected trace math functions.

Remote command:

[CALC:MATH:STAT OFF](#), see [CALCulate<n>:MATH<t>:STATe](#) on page 122

6.2 Configure numerical result displays

Access: "Overview" > "Numerical Results"

The "Numerical" tab of the "Results" dialog box contains all functions necessary to set up and configure the numerical phase noise result displays.

Results

Limits **Graphical** **Numerical**

Residual Noise

Range	Meas	Manual	1.0 kHz	1.0 MHz
User Ranges	None	▼	1.0 kHz	1.0 MHz
	None	▼	1.0 kHz	1.0 MHz
	None	▼	1.0 kHz	1.0 MHz

Spot Noise

Sort by Frequency: On Off

On all Decade Edges: On Off

On User Defined Offsets: On Off

<input checked="" type="checkbox"/>	1.0 kHz
<input checked="" type="checkbox"/>	10.0 kHz
<input checked="" type="checkbox"/>	100.0 kHz
<input checked="" type="checkbox"/>	1.0 MHz
<input checked="" type="checkbox"/>	10.0 MHz

6.2.1 Configuring residual noise measurements

Meas Range.....	62
User Range.....	63

Meas Range

Turns the integration of the entire measurement range for residual noise calculations on and off.

The range defined here is applied to all traces.

"Meas"	The application calculates the residual noise over the entire measurement range.
"Manual"	The application calculates the residual noise over a customized range. The input fields become available to define a customized integration range. The application shows two red lines ("EL1" and "EL2") in the graphical result display to indicate the custom range.

Remote command:

Turn customized range on and off:

[CALCulate<n>:EVALuation\[:STATe\]](#) on page 133

Define start point of custom range:

[CALCulate<n>:EVALuation:START](#) on page 133

Define end point of custom range:

[CALCulate<n>:EVALuation:USER<range>:STOP](#) on page 134

User Range

Defines a custom range for residual noise calculations. You have to assign a user range to a particular trace.

In the default state, user ranges are inactive. "None" is selected in the dropdown menu. If you assign the user range to a trace by selecting one of the traces from the dropdown menu, the input fields next to the trace selection become active. In these fields, you can define a start and stop offset frequency.

Remote command:

Selecting a trace:

[CALCulate<n>:EVALuation:USER<range>:TRACe](#) on page 135

Define start frequency of user range:

[CALCulate<n>:EVALuation:START](#) on page 133

Define stop frequency of user range:

[CALCulate<n>:EVALuation:USER<range>:STOP](#) on page 134

6.2.2 Configuring spot noise measurements

Sort by Frequency	63
On All Decade Edges	63
On User Defined Offsets / Offset Frequency	64

Sort by Frequency

If enabled, the spot noise result table is sorted in ascending order of the offset frequency from the carrier.

On All Decade Edges

Turns the calculation of spot noise on all 10^x offset frequencies on and off.

Remote command:

Turn on and off spot noise calculation on 10^x offset frequencies:

[CALCulate<n>:SNOise<m>:DECades\[:STATe\]](#) on page 139

Querying spot noise results on 10^x offset frequencies:

[CALCulate<n>:SNOise<m>:DECades:X](#) on page 139

[CALCulate<n>:SNOise<m>:DECades:Y](#) on page 139

On User Defined Offsets / Offset Frequency

Turns custom spot noise frequencies on and off.

If on, the "Offset Frequency" input fields become available. You can measure the spot noise for up to five custom offset frequencies. If active, the application adds those spots to the spot noise table.

Remote command:

Turning spot noise marker on and off:

[CALCulate<n>:SNOise<m>:DECades\[:STATe\]](#) on page 139

[CALCulate<n>:SNOise<m>:AOFF](#) on page 138

Positioning spot noise markers:

[CALCulate<n>:SNOise<m>:X](#) on page 140

Querying custom spot noise results:

[CALCulate<n>:SNOise<m>:Y](#) on page 141

6.3 Using limit lines

Access: "Overview" > "Limit Analysis"

The "Limits" tab of the "Results" dialog box contains all functions necessary to set up and configure limit lines.

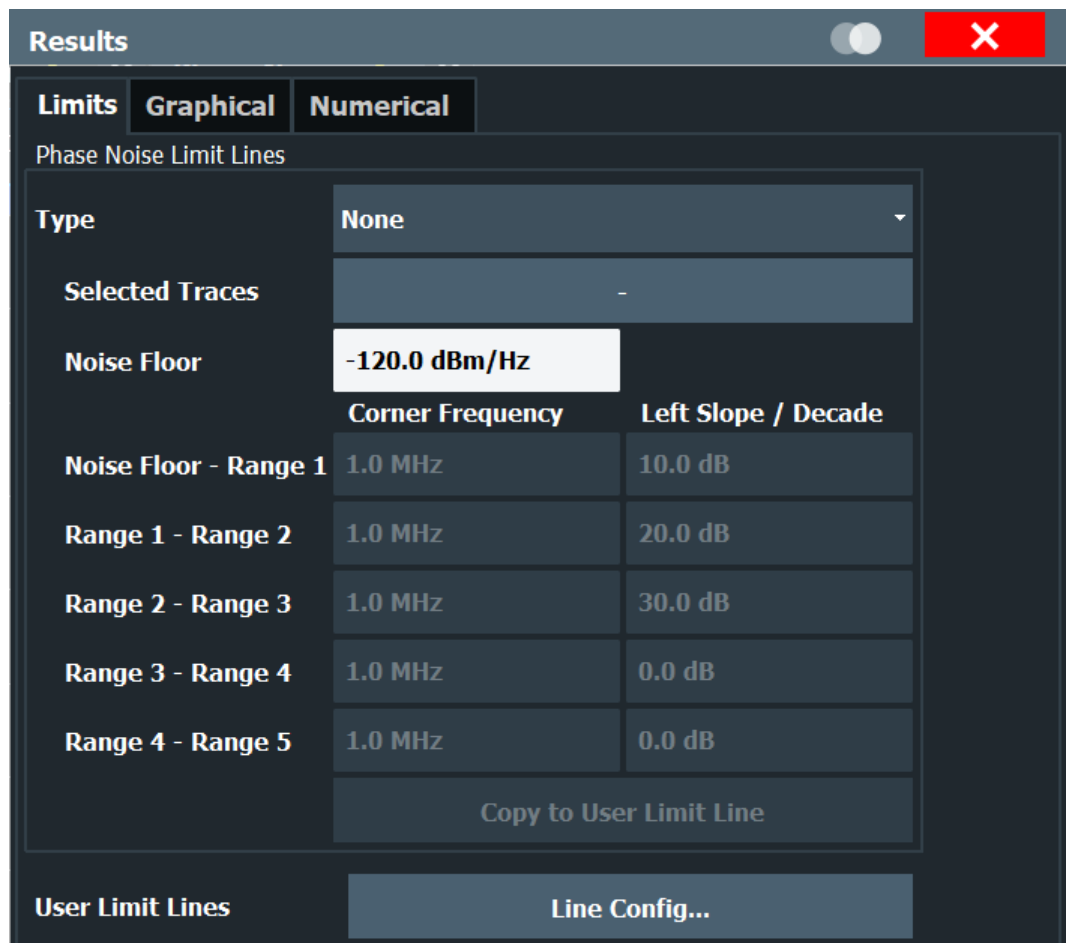

6.3.1 Using phase noise limit lines

Phase Noise Limit Line.....	65
Selected Traces.....	65
Noise Floor.....	66
Range x - Range y.....	66
Copy to User Limit Line.....	66

Phase Noise Limit Line

Selects the shape of the phase noise limit line.

For more information see [Chapter 4.9, "Using limit lines"](#), on page 33.

"None" No limit line.

"Noise floor Limit line defined by the noise floor and x corner frequencies and
and x Ranges" slopes. The application supports up to 5 ranges.

Remote command:

[CALCulate<n>:PNLimit:TYPE](#) on page 111

Selected Traces

Selects the trace(s) to assign a phase noise limit line to.

For more information see [Chapter 4.9, "Using limit lines"](#), on page 33.

Remote command:

`CALCulate<n>:PNLimit:TRACe` on page 111

Noise Floor

Defines the noise floor level in dBm/Hz of the DUT.

For more information see [Chapter 4.9, "Using limit lines"](#), on page 33.

Remote command:

`CALCulate<n>:PNLimit:NOISe` on page 111

Range x - Range y

Defines the corner frequencies and slope for a particular segment of phase noise limit lines.

The slope defines the slope of the limit line segment to the left of the corner frequency.

For more information see [Chapter 4.9, "Using limit lines"](#), on page 33.

Remote command:

Corner frequencies:

`CALCulate<n>:PNLimit:FC<1 to 5>` on page 110

Slope:

`CALCulate<n>:PNLimit:SLOPe<segment>` on page 112

Copy to User Limit Line

Creates a new user limit line from the data of a phase noise limit line.

The file is stored in the default folder for user limit lines. You can load and edit the limit line via the "Select Limit Line" dialog box. For more information see ["Select Limit Line"](#) on page 67.

Remote command:

`CALCulate<n>:PNLimit:COpy<k>` on page 110

6.3.2 Selecting standard limit lines

Access: "Overview" > "Limit Analysis" > "Line Config"

Select Limit Line.....	67
L Name.....	67
L Unit.....	67
L Compatible.....	67
L Visible.....	67
L Check Traces.....	68
L Comment.....	68
L View Filter.....	68
L New / Edit / Copy To.....	68
L Delete.....	68
L Disable All Lines.....	69

Select Limit Line

The "Select Limit Line" dialog box contains functionality to include standard limit lines in the measurement.

The dialog box consists of a table that shows all available limit lines and their characteristics and a few buttons to manage individual limit lines.

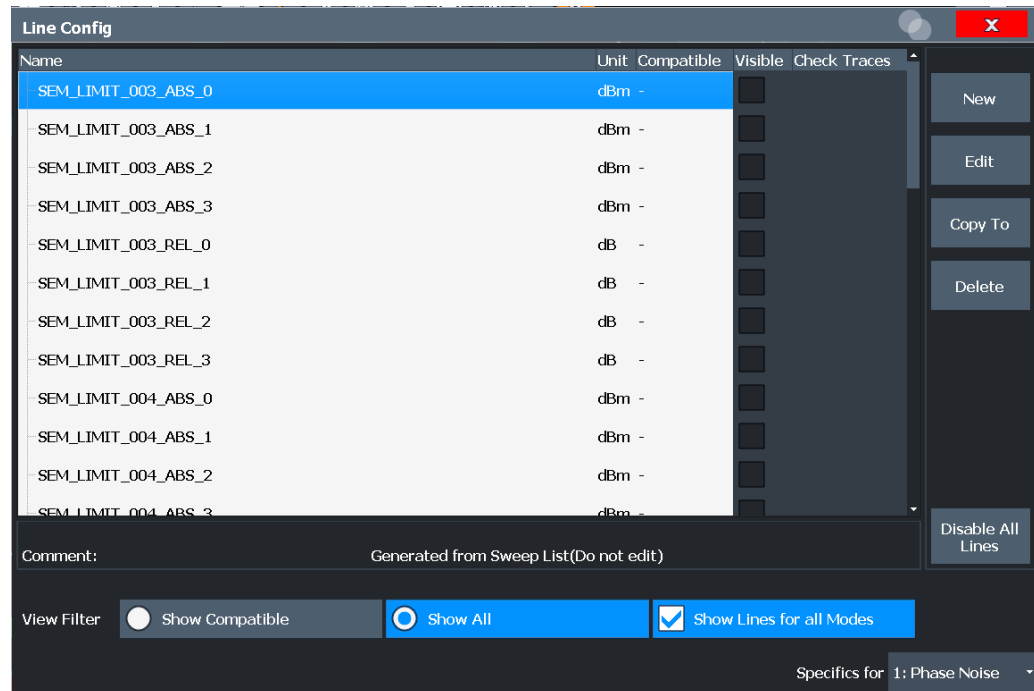

Name ← Select Limit Line

Shows the name of the limit line.

Unit ← Select Limit Line

Shows the unit of the limit line.

Compatible ← Select Limit Line

Shows if the limit line is compatible to the current measurement setup or not.

"Yes" You can use the limit line because it is compatible to the current measurement setup.

"No" You cannot use the limit line because it is compatible to the current measurement setup.

Visible ← Select Limit Line

Displays a limit line in the diagram area.

You can display up to eight limit lines at the same time.

Remote command:

Display a limit line:

Lower limit: `CALCulate<n>:LIMit:LOWer:STATe` on page 115

Upper limit: `CALCulate<n>:LIMit:UPPer:STATe` on page 117

Query all visible limit lines:

[CALCulate<n>:LIMit:ACTive?](#) on page 113

Check Traces ← **Select Limit Line**

Turns the limit check for a particular trace on and off.

Remote command:

Assign a limit line to a particular trace:

[CALCulate<n>:LIMit:TRACe<t>](#) on page 116

Activate the limit check:

[CALCulate<n>:LIMit:STATe](#) on page 115

Querying limit check results:

[CALCulate<n>:LIMit:FAIL?](#) on page 114

Comment ← **Select Limit Line**

Shows the comment of the selected limit line. If the limit line has no comment, this field stays empty.

View Filter ← **Select Limit Line**

Turns filter for the list of limit lines on and off.

By default, the list includes all limit lines that are stored on the R&S FPL1000.

"Show Com- patible"	Filters the list of limit lines by compatibility. If on, the list includes only those limit lines that are compatible to the current measurement setup.
"Show Lines For PNoise"	Filters the list of limit lines by compatibility to phase noise measurements. If on, the list includes only those limit lines that are compatible to phase noise measurements.

New / Edit / Copy To ← **Select Limit Line**

All three buttons open the "Edit Limit Line" dialog box to create or edit limit lines.

When you use the "New" button, the dialog box contains no data.

When you use the "Edit" button, the dialog box contains the data of the previously selected limit line.

When you use the "Copy To" button, the dialog box also contains a copy the data of the previously selected limit line.

Remote command:

New:

[CALCulate<n>:LIMit:NAME](#) on page 115

Copy:

[CALCulate<n>:LIMit:COPY](#) on page 113

Delete ← **Select Limit Line**

Deletes the selected limit line.

Remote command:

[CALCulate<n>:LIMit:DELete](#) on page 114

Disable All Lines ← Select Limit Line

Turns all active limit lines off.

6.3.3 Creating and editing standard limit lines

Access: "Overview" > "Limit Analysis" > "Line Config" > "New" / "Edit" > "Copy To"

Edit Limit Line.....	69
L Name.....	69
L Comment.....	70
L X-Axis.....	70
L Y-Axis.....	70
L Data Points.....	70
L Insert Value.....	71
L Delete Value.....	71
L Shift X.....	71
L Shift Y.....	71
L Save.....	71

Edit Limit Line

The "Edit Limit Line" dialog box contains functionality to describe the shape of a limit line.

Because limit lines have to meet certain conditions for phase noise measurements, the availability of parameters is limited.

Name ← Edit Limit Line

Defines the name of a limit line.

Remote command:

[CALCulate<n>:LIMit:NAME](#) on page 115

Comment ← Edit Limit Line

Defines a comment for the limit line.

A comment is not mandatory.

Remote command:

[CALCulate<n>:LIMit:COMMent](#) on page 117

X-Axis ← Edit Limit Line

Defines the characteristics of the horizontal axis.

The characteristics consist of the unit, the scaling and the type of values.

In the Phase Noise application, the unit for the horizontal axis is always Hz. The scaling can either be logarithmic or linear

"Unit" In the Phase Noise application, the unit is always Hz.

"Scaling" In the Phase Noise application, the scaling of the horizontal axis is always logarithmic.

"Type of Values" The type of values can be absolute values or relative to the nominal frequency.

Remote command:

Type of values:

[CALCulate<n>:LIMit:LOWer:MODE](#) on page 119

[CALCulate<n>:LIMit:UPPer:MODE](#) on page 119

Y-Axis ← Edit Limit Line

Defines the characteristics of the vertical axis.

The characteristics consist of the unit, the type of values and the usage of the line.

"Unit" In the Phase Noise application, the unit is always dBc/Hz.

"Type of Values" In the Phase Noise application, the type of values is always absolute.

"Line usage" Selects if the limit line is used as an upper or lower limit line.

Data Points ← Edit Limit Line

The data points define the shape of the limit line. A limit line consists of at least 2 data points and a maximum of 200 data points.

A data point is defined by its position in horizontal ("Position" column) and vertical direction ("Value" column). The position of the data points have to be in ascending order.

Remote command:

Horizontal data (position):

[CALCulate<n>:LIMit:CONTrol\[:DATA\]](#) on page 117

Vertical data (value):

Lower limit: [CALCulate<n>:LIMit:LOWer\[:DATA\]](#) on page 118

Upper limit: [CALCulate<n>:LIMit:UPPer\[:DATA\]](#) on page 120

Insert Value ← Edit Limit Line

Insert a new limit line data point below the selected data point.

Delete Value ← Edit Limit Line

Deletes the selected limit line data point.

Shift X ← Edit Limit Line

Shifts each data point horizontally by a particular amount.

Remote command:

`CALCulate<n>:LIMit:CONTRol:SHIFt` on page 118

Shift Y ← Edit Limit Line

Shifts each data point vertically by a particular amount.

Remote command:

Lower limit: `CALCulate<n>:LIMit:LOWer:SHIFt` on page 119

Upper limit: `CALCulate<n>:LIMit:UPPer:SHIFt` on page 120

Save ← Edit Limit Line

Saves the limit line or the changes you have made to a limit line.

6.4 Using markers

Access (marker position): [MKR] > "Marker Config" > "Markers"

Access (marker settings): [MKR] > "Marker Config" > "Marker Settings"

The "Marker Configuration" dialog box and the "Marker" menu contain all functionality necessary to control markers.

The "Marker Configuration" dialog box consists of two tabs.

The "Markers" tab contains functionality to define characteristics for each marker.

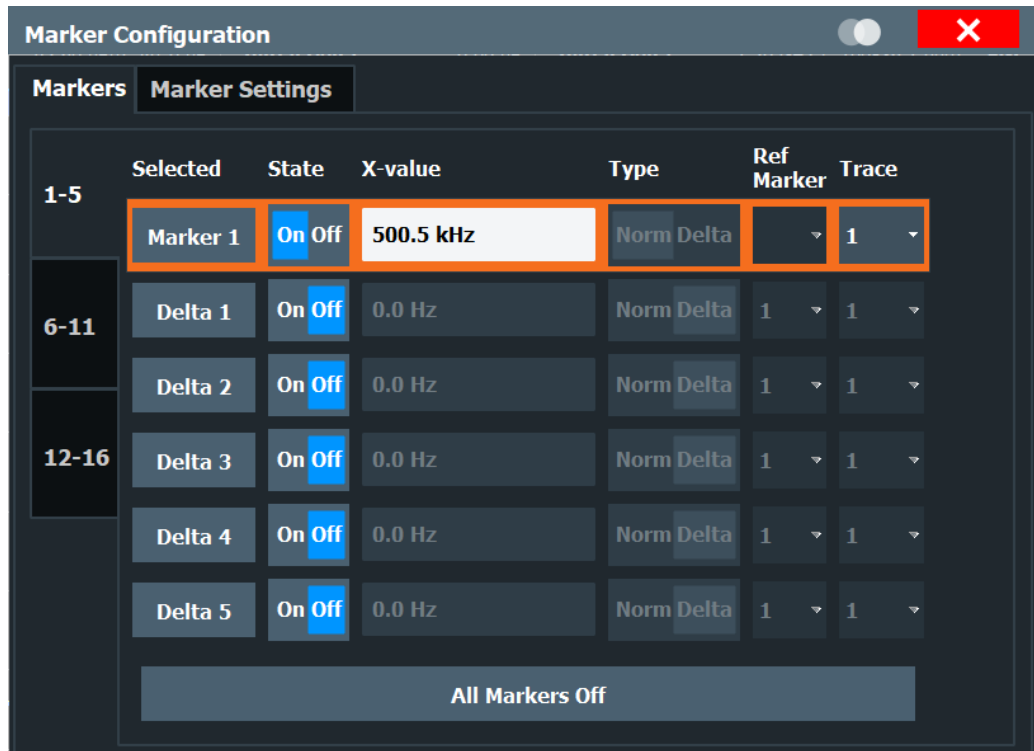

The "Marker Settings" tab contains general marker functionality.

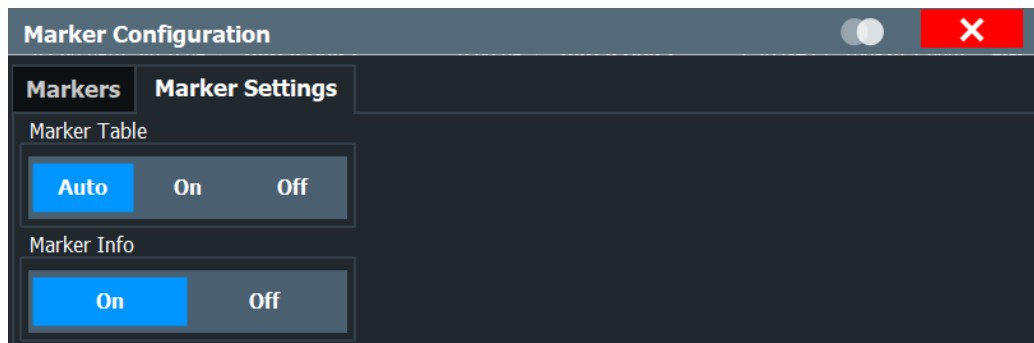

Marker 1 ... Marker x..... 72
 Marker Type..... 73
 Reference Marker..... 73
 Assigning the Marker to a Trace..... 73
 Marker Zoom..... 73
 All Markers Off..... 74
 Marker Table Display..... 74
 Marker Info..... 74

Marker 1 ... Marker x

Selects and turns the corresponding marker on and off.

Turning on a marker also opens an input field to define the horizontal position of the marker.

In the "Marker Configuration" dialog box, you can also define the horizontal position of each marker ("x-value").

By default, the first marker you turn on is a normal marker, all others are delta markers.

Remote command:

[CALCulate<n>:MARKer<m>\[:STATe\]](#) on page 147

[CALCulate<n>:DELTAmarker<m>\[:STATe\]](#) on page 149

Marker Type

Toggles the marker type.

The type for marker 1 is always "Normal", the type for delta marker 1 is always "Delta". These types cannot be changed.

Note: If normal marker 1 is the active marker, switching the "Mkr Type" activates an additional delta marker 1. For any other marker, switching the marker type does not activate an additional marker, it only switches the type of the selected marker.

"Normal" A normal marker indicates the absolute value at the defined position in the diagram.

"Delta" A delta marker defines the value of the marker relative to the specified reference marker (marker 1 by default).

Remote command:

[CALCulate<n>:MARKer<m>\[:STATe\]](#) on page 147

[CALCulate<n>:DELTAmarker<m>\[:STATe\]](#) on page 149

Reference Marker

Defines a marker as the reference marker which is used to determine relative analysis results (delta marker values).

Remote command:

[CALCulate<n>:DELTAmarker<m>:MREference](#) on page 149

Assigning the Marker to a Trace

The "Trace" setting assigns the selected marker to an active trace. The trace determines which value the marker shows at the marker position. If the marker was previously assigned to a different trace, the marker remains on the previous frequency or time, but indicates the value of the new trace.

If a trace is turned off, the assigned markers and marker functions are also deactivated.

Remote command:

[CALCulate<n>:MARKer<m>:TRACe](#) on page 147

Marker Zoom

Turns the marker zoom on and off.

The marker zoom magnifies the diagram area around marker 1 by a certain factor.

Turning on the zoom also opens an input field to define the zoom factor.

Remote command:

Turning on the zoom:

[DISPlay\[:WINDow<n>\]:ZOOM\[:STATe\]](#) on page 152

Defining the zoom factor:

[CALCulate<n>:MARKer<m>:FUNction:ZOOM](#) on page 152

All Markers Off

Deactivates all markers in one step.

Remote command:

[CALCulate<n>:MARKer<m>:AOFF](#) on page 147

Marker Table Display

Defines how the marker information is displayed.

"On"	Displays the marker information in a table in a separate area beneath the diagram.
"Off"	No separate marker table is displayed. If Marker Info is active, the marker information is displayed within the diagram area.
"Auto"	(Default) If more than two markers are active, the marker table is displayed automatically. If Marker Info is active, the marker information for up to two markers is displayed in the diagram area.

Remote command:

[DISPlay\[:WINDow<n>\]:MTABLE](#) on page 152

Marker Info

Turns the marker information displayed in the diagram on and off.

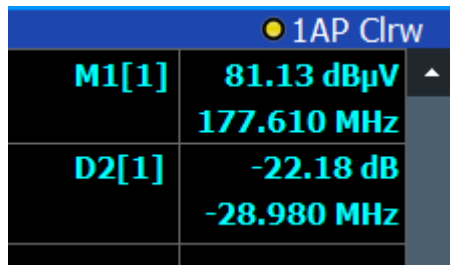

1AP Clrw	
M1[1]	81.13 dBµV 177.610 MHz
D2[1]	-22.18 dB -28.980 MHz

Remote command:

[DISPlay\[:WINDow<n>\]:MINFo\[:STATe\]](#) on page 151

7 How to configure phase noise measurements

7.1 Performing a basic phase noise measurement

1. In the Spectrum application, define the center frequency of the DUT.
2. Enter the "Phase Noise" application.
The R&S FPL1000-K40 starts the measurement with the default configuration. The default configuration defines most settings automatically.
If you need any custom configuration, define them after entering the Phase Noise application.
3. Layout the display as required via the SmartGrid.
4. Open the "Overview" dialog box to configure the measurement.
5. Configure the frontend (frequency, level etc.) via the "Frontend" dialog box.
6. Define the measurement range via the "Phase Noise" dialog box.
7. Turn on frequency and level tracking via the "Control" dialog box.
8. Run a single sweep.
9. Turn on a marker and read out the results.
10. Read out the residual noise over the measurement range.
11. Customize a residual noise range and read out the results.
12. Freeze trace 1 and 2 (trace mode: View).
13. Turn on trace 3 and 4 (trace mode: Clear/Write).
14. Switch the measurement mode to "IQ FFT" in the "Phase Noise" dialog box.
15. Repeat the measurement.

7.2 Customizing the measurement range

The application provides several ways to customize. Each method features a different level of details you can define.

1. Open the "Phase Noise" configuration via the "Overview" dialog box or the "Meas Config" softkey menu.

2. Define the frequency offset range you would like to measure in the corresponding fields.
3. Select the "Sweep Type".
 - a) Select sweep types "Fast", "Normal" or "Averaged" for automatic measurement configuration.

For a custom configuration, proceed to set up each measurement parameter separately.
4. Define the "RBW", number of "Averages", sweep "Mode" and "I/Q Window" function.
 - a) Define the parameters globally for all (half) decades covered by the measurement range.
 - b) Define the parameters for each individual (half) decade covered by the measurement range in the "Half Decade Configuration Table".

8 Remote control commands for phase noise measurements

The following remote control commands are required to configure and perform phase noise measurements in a remote environment. The R&S FPL1000 must already be configured for remote operation in a network as described in the base unit manual.



Universal functionality

Note that basic tasks that are also performed in the base unit in the same way are not described here. For a description of such tasks, see the R&S FPL1000 user manual.

In particular, this includes:

- Managing settings and results, i.e. storing and loading settings and result data.
- Basic instrument configuration, e.g. checking the system configuration, customizing the screen layout, or configuring networks and remote operation.
- Using the common status registers (specific status registers for pulse measurements are not used).

• Common suffixes	77
• Introduction	78
• Controlling the phase noise measurement channel	82
• Performing measurements	86
• Configuring the result display	90
• Configuring the frontend	98
• Controlling the measurement	99
• Configuring the measurement range	103
• Using limit lines	110
• Graphical display of phase noise results	120
• Configure numerical result displays	133
• Using markers	146
• Configuring in- and outputs	153
• Independent CW source commands	154
• Automatic measurement configuration	156
• Using the status register	157
• Remote control example scripts	163

8.1 Common suffixes

In the R&S FPL Phase Noise Measurement application, the following common suffixes are used in remote commands:

Table 8-1: Common suffixes used in remote commands in the R&S FPL Phase Noise Measurement application

Suffix	Value range	Description
<m>	1 to 16	Marker
<n>	1 to 16	Window (in the currently selected channel setup)
<t>	1 to 4	Trace
	1 to 8	Limit line

8.2 Introduction

Commands are program messages that a controller (e.g. a PC) sends to the instrument or software. They operate its functions ('setting commands' or 'events') and request information ('query commands'). Some commands can only be used in one way, others work in two ways (setting and query). If not indicated otherwise, the commands can be used for settings and queries.

The syntax of a SCPI command consists of a header and, usually, one or more parameters. To use a command as a query, you have to append a question mark after the last header element, even if the command contains a parameter.

A header contains one or more keywords, separated by a colon. Header and parameters are separated by a "white space" (ASCII code 0 to 9, 11 to 32 decimal, e.g. blank). If there is more than one parameter for a command, they are separated by a comma from one another.

Only the most important characteristics that you need to know when working with SCPI commands are described here. For a more complete description, refer to the user manual of the R&S FPL1000.



Remote command examples

Note that some remote command examples mentioned in this general introduction are possibly not supported by this particular application.

8.2.1 Conventions used in descriptions

The following conventions are used in the remote command descriptions:

- Command usage**
 If not specified otherwise, commands can be used both for setting and for querying parameters.
 If a command can be used for setting or querying only, or if it initiates an event, the usage is stated explicitly.
- Parameter usage**
 If not specified otherwise, a parameter can be used to set a value and it is the result of a query.
 Parameters required only for setting are indicated as **Setting parameters**.

Parameters required only to refine a query are indicated as **Query parameters**. Parameters that are only returned as the result of a query are indicated as **Return values**.

- **Conformity**

Commands that are taken from the SCPI standard are indicated as **SCPI confirmed**. All commands used by the R&S FPL1000 follow the SCPI syntax rules.

- **Asynchronous commands**

A command which does not automatically finish executing before the next command starts executing (overlapping command) is indicated as an **Asynchronous command**.

- **Reset values (*RST)**

Default parameter values that are used directly after resetting the instrument (*RST command) are indicated as *RST values, if available.

- **Default unit**

The default unit is used for numeric values if no other unit is provided with the parameter.

- **Manual operation**

If the result of a remote command can also be achieved in manual operation, a link to the description is inserted.

8.2.2 Long and short form

The keywords have a long and a short form. You can use either the long or the short form, but no other abbreviations of the keywords.

The short form is emphasized in uppercase letters. Note however, that this emphasis only serves the purpose to distinguish the short from the long form in the manual. For the instrument, the case does not matter.

Example:

`SENSe:FREQuency:CENTer` is the same as `SENS:FREQ:CENT`.

8.2.3 Numeric suffixes

Some keywords have a numeric suffix if the command can be applied to multiple instances of an object. In that case, the suffix selects a particular instance (e.g. a measurement window).

Numeric suffixes are indicated by angular brackets (<n>) next to the keyword.

If you do not quote a suffix for keywords that support one, a 1 is assumed.

Example:

`DISPlay[:WINDow<1...4>]:ZOOM:STATe` enables the zoom in a particular measurement window, selected by the suffix at `WINDow`.

`DISPlay:WINDow4:ZOOM:STATe ON` refers to window 4.

8.2.4 Optional keywords

Some keywords are optional and are only part of the syntax because of SCPI compliance. You can include them in the header or not.



If an optional keyword has a numeric suffix and you need to use the suffix, you have to include the optional keyword. Otherwise, the suffix of the missing keyword is assumed to be the value 1.

Optional keywords are emphasized with square brackets.

Example:

Without a numeric suffix in the optional keyword:

```
[SENSe:]FREQuency:CENTer is the same as FREQuency:CENTer
```

With a numeric suffix in the optional keyword:

```
DISPlay[:WINDow<1...4>]:ZOOM:STATe
```

DISPlay:ZOOM:STATe ON enables the zoom in window 1 (no suffix).

DISPlay:WINDow4:ZOOM:STATe ON enables the zoom in window 4.

8.2.5 Alternative keywords

A vertical stroke indicates alternatives for a specific keyword. You can use both keywords to the same effect.

Example:

```
[SENSe:]BANDwidth|BWIDth[:RESolution]
```

In the short form without optional keywords, BAND 1MHZ would have the same effect as BWID 1MHZ.

8.2.6 SCPI parameters

Many commands feature one or more parameters.

If a command supports more than one parameter, they are separated by a comma.

Example:

```
LAYout:ADD:WINDow Spectrum,LEFT,MTABLE
```

Parameters can have different forms of values.

- [Numeric values](#)..... 81
- [Boolean](#).....81
- [Character data](#)..... 82
- [Character strings](#).....82
- [Block data](#)..... 82

8.2.6.1 Numeric values

Numeric values can be entered in any form, i.e. with sign, decimal point or exponent. For physical quantities, you can also add the unit. If the unit is missing, the command uses the basic unit.

Example:

With unit: `SENSe:FREQuency:CENTer 1GHZ`

Without unit: `SENSe:FREQuency:CENTer 1E9` would also set a frequency of 1 GHz.

Values exceeding the resolution of the instrument are rounded up or down.

If the number you have entered is not supported (e.g. for discrete steps), the command returns an error.

Instead of a number, you can also set numeric values with a text parameter in special cases.

- **MIN/MAX**
Defines the minimum or maximum numeric value that is supported.
- **DEF**
Defines the default value.
- **UP/DOWN**
Increases or decreases the numeric value by one step. The step size depends on the setting. Sometimes, you can customize the step size with a corresponding command.

Querying numeric values

When you query numeric values, the system returns a number. For physical quantities, it applies the basic unit (e.g. Hz for frequencies). The number of digits after the decimal point depends on the type of numeric value.

Example:

Setting: `SENSe:FREQuency:CENTer 1GHZ`

Query: `SENSe:FREQuency:CENTer?` would return `1E9`

Sometimes, numeric values are returned as text.

- **INF/NINF**
Infinity or negative infinity. Represents the numeric values 9.9E37 or -9.9E37.
- **NAN**
Not a number. Represents the numeric value 9.91E37. NAN is returned if errors occur.

8.2.6.2 Boolean

Boolean parameters represent two states. The "on" state (logically true) is represented by "ON" or the numeric value 1. The "off" state (logically untrue) is represented by "OFF" or the numeric value 0.

Querying Boolean parameters

When you query Boolean parameters, the system returns either the value 1 ("ON") or the value 0 ("OFF").

Example:

Setting: `DISPlay:WINDow:ZOOM:STATe ON`

Query: `DISPlay:WINDow:ZOOM:STATe?` would return 1

8.2.6.3 Character data

Character data follows the syntactic rules of keywords. You can enter text using a short or a long form. For more information, see [Chapter 8.2.2, "Long and short form"](#), on page 79.

Querying text parameters

When you query text parameters, the system returns its short form.

Example:

Setting: `SENSe:BANDwidth:RESolution:TYPE NORMal`

Query: `SENSe:BANDwidth:RESolution:TYPE?` would return NORM

8.2.6.4 Character strings

Strings are alphanumeric characters. They have to be in straight quotation marks. You can use a single quotation mark (') or a double quotation mark (").

Example:

`INSTRument:DELeTe 'Spectrum'`

8.2.6.5 Block data

Block data is a format which is suitable for the transmission of large amounts of data.

The ASCII character # introduces the data block. The next number indicates how many of the following digits describe the length of the data block. The data bytes follow. During the transmission of these data bytes, all end or other control signs are ignored until all bytes are transmitted. #0 specifies a data block of indefinite length. The use of the indefinite format requires an `NL^END` message to terminate the data block. This format is useful when the length of the transmission is not known or if speed or other considerations prevent segmentation of the data into blocks of definite length.

8.3 Controlling the phase noise measurement channel

The following commands are necessary to control the measurement channel.

INSTrument:CREate:DUPLicate.....	83
INSTrument:CREate[:NEW].....	83
INSTrument:CREate:REPLace.....	83
INSTrument:DELeTe.....	84
INSTrument:LIST?.....	84
INSTrument:REName.....	85
INSTrument[:SELect].....	85
SYSTem:PRESet:CHANnel[:EXEC].....	86

INSTrument:CREate:DUPLicate

This command duplicates the currently selected channel setup, i.e creates a new channel setup of the same type and with the identical measurement settings. The name of the new channel setup is the same as the copied channel setup, extended by a consecutive number (e.g. "IQAnalyzer" -> "IQAnalyzer 2").

The channel setup to be duplicated must be selected first using the `INST:SEL` command.

Example:

```
INST:SEL 'IQAnalyzer'
```

```
INST:CRE:DUPL
```

Duplicates the channel setup named 'IQAnalyzer' and creates a new channel setup named 'IQAnalyzer2'.

Usage: Event

INSTrument:CREate[:NEW] <ChannelType>, <ChannelName>

This command adds a measurement channel. You can configure up to 10 measurement channels at the same time (depending on available memory).

Parameters:

<ChannelType> Channel type of the new channel.
For a list of available channel types, see [INSTrument:LIST?](#) on page 84.

<ChannelName> String containing the name of the channel.
Note that you cannot assign an existing channel name to a new channel. If you do, an error occurs.

Example:

```
INST:CRE SAN, 'Spectrum 2'
```

Adds a spectrum display named "Spectrum 2".

INSTrument:CREate:REPLace <ChannelName1>,<ChannelType>,<ChannelName2>

This command replaces a channel setup with another one.

Setting parameters:

<ChannelName1> String containing the name of the channel setup you want to replace.

<ChannelType>	Channel type of the new channel setup. For a list of available channel setup types, see INSTrument:LIST? on page 84.
<ChannelName2>	String containing the name of the new channel setup. Note: If the specified name for a new channel setup already exists, the default name, extended by a sequential number, is used for the new channel setup (see INSTrument:LIST? on page 84). Channel names can have a maximum of 31 characters, and must be compatible with the Windows conventions for file names. In particular, they must not contain special characters such as ":", "*", "?".
Example:	<pre>INST:CRE:REPL 'IQAnalyzer2',IQ,'IQAnalyzer'</pre> Replaces the channel setup named "IQAnalyzer2" by a new channel setup of type "IQ Analyzer" named "IQAnalyzer".
Usage:	Setting only

INSTrument:DELeTe <ChannelName>

This command deletes a channel setup.

Setting parameters:

<ChannelName>	String containing the name of the channel setup you want to delete. A channel setup must exist to delete it.
Usage:	Setting only

INSTrument:LIST?

This command queries all active channel setups. The query is useful to obtain the names of the existing channel setups, which are required to replace or delete the channel setups.

Return values:

<ChannelType>, <ChannelName>	For each channel setup, the command returns the channel setup type and channel setup name (see tables below). Tip: to change the channel setup name, use the INSTrument:REName command.
---------------------------------	--

Example:	<pre>INST:LIST?</pre> Result for 3 channel setups: 'ADEM','Analog Demod','IQ','IQ Analyzer','IQ','IQ Analyzer2'
-----------------	---

Usage:	Query only
---------------	------------

Table 8-2: Available channel setup types and default channel setup names

Application	<ChannelType> Parameter	Default Channel setup Name*)
Spectrum	SANALYZER	Spectrum
AM/FM/PM Modulation Analysis	ADEM	Analog Demod
I/Q Analyzer	IQ	IQ Analyzer
Noise Figure Measurements	NOISE	Noise
Vector Signal Analysis (VSA)	DDEM	VSA

Note: the default channel setup name is also listed in the table. If the specified name for a new channel setup already exists, the default name, extended by a sequential number, is used for the new channel setup.

INSTrument:REName <ChannelName1>, <ChannelName2>

This command renames a channel setup.

Setting parameters:

<ChannelName1> String containing the name of the channel setup you want to rename.

<ChannelName2> String containing the new channel setup name.
Note that you cannot assign an existing channel setup name to a new channel setup. If you do, an error occurs.
Channel names can have a maximum of 31 characters, and must be compatible with the Windows conventions for file names. In particular, they must not contain special characters such as ":", "*", "?".

Example: `INST:REN 'IQAnalyzer2', 'IQAnalyzer3'`
Renames the channel setup with the name 'IQAnalyzer2' to 'IQAnalyzer3'.

Usage: Setting only

INSTrument[:SElect] <Application>

Selects the measurement application (channel type) for the current channel.

See also `INSTrument:CREate[:NEW]` on page 83.

For a list of available channel types see `INSTrument:LIST?` on page 84.

Parameters:

<Application> **PNOise**
Phase noise measurements, R&S FPL1000–K40

SYSTem:PRESet:CHANnel[:EXEC]

This command restores the default instrument settings in the current channel setup.

Use `INST:SEL` to select the channel setup.

Example: `INST:SEL 'Spectrum2'`
 Selects the channel setup for "Spectrum2".
 `SYST:PRESet:CHAN:EXEC`
 Restores the factory default settings to the "Spectrum2"channel
 setup.

Usage: Event

Manual operation: See "[Preset Channel setup](#)" on page 40

8.4 Performing measurements

The following commands are necessary to perform measurements.



You can also perform a sequence of measurements using the Sequencer (see "[Multiple Measurement Channels and Sequencer Function](#)" on page 11).

ABORt	86
CONFigure:REFMeas	87
INITiate<n>:CONMeas	87
INITiate<n>:CONTinuous	87
INITiate<n>[:IMMediate]	88
INITiate:SEQuencer:ABORt	88
INITiate:SEQuencer:IMMediate	89
INITiate:SEQuencer:MODE	89
[SENSe:]SWEEp:FHDecade	89
SYSTem:SEQuencer	90

ABORt

This command aborts the measurement in the current channel setup and resets the trigger system.

To prevent overlapping execution of the subsequent command before the measurement has been aborted successfully, use the `*OPC?` or `*WAI` command after `ABOR` and before the next command.

For details on overlapping execution see [Remote control via SCPI](#).

Note on blocked remote control programs:

If a sequential command cannot be completed, for example because a triggered sweep never receives a trigger, the remote control program will never finish and the remote channel to the R&S FPL1000 is blocked for further commands. In this case, you must interrupt processing on the remote channel first in order to abort the measurement.

To do so, send a "Device Clear" command from the control instrument to the R&S FPL1000 on a parallel channel to clear all currently active remote channels. Depending on the used interface and protocol, send the following commands:

- **Visa:** `viClear()`

Now you can send the `ABORt` command on the remote channel performing the measurement.

Example: `ABOR; :INIT:IMM`
Aborts the current measurement and immediately starts a new one.

Example: `ABOR; *WAI`
`INIT:IMM`
Aborts the current measurement and starts a new one once abortion has been completed.

Usage: Event

CONFigure:REFMeas <arg0>

This command initiates a reference measurement that determines the inherent phase noise of the R&S FPL1000.

Parameters:
<arg0> ONCE

Example: `CONF:REFM ONCE`
Initiates a reference measurement

Manual operation: See "[Reference Measurement](#)" on page 23

INITiate<n>:CONMeas

This command restarts a (single) measurement that has been stopped (using `ABORt`) or finished in single sweep mode.

The measurement is restarted at the beginning, not where the previous measurement was stopped.

Suffix:
<n> irrelevant

Manual operation: See "[Continue Single Sweep](#)" on page 50

INITiate<n>:CONTInuous <State>

This command controls the sweep mode for an individual channel setup.

Note that in single sweep mode, you can synchronize to the end of the measurement with *OPC, *OPC? or *WAI. In continuous sweep mode, synchronization to the end of the measurement is not possible. Thus, it is not recommended that you use continuous sweep mode in remote control, as results like trace data or markers are only valid after a single sweep end synchronization.

For details on synchronization see [Remote control via SCPI](#).

Suffix:

<n> irrelevant

Parameters:

<State> ON | OFF | 0 | 1

ON | 1

Continuous sweep

OFF | 0

Single sweep

*RST: 1 (some applications can differ)

Example:

INIT:CONT OFF

Switches the sweep mode to single sweep.

INIT:CONT ON

Switches the sweep mode to continuous sweep.

Manual operation: See "[Continuous Sweep / Run Cont](#)" on page 49

INITiate<n>[:IMMEDIATE]

This command starts a (single) new measurement.

With sweep count or average count > 0, this means a restart of the corresponding number of measurements. With trace mode MAXHold, MINHold and AVERage, the previous results are reset on restarting the measurement.

You can synchronize to the end of the measurement with *OPC, *OPC? or *WAI.

For details on synchronization see [Remote control via SCPI](#).

Suffix:

<n> irrelevant

Manual operation: See "[Single Sweep / Run Single](#)" on page 50

INITiate:SEQuencer:ABORt

This command stops the currently active sequence of measurements.

You can start a new sequence any time using [INITiate:SEQuencer:IMMEDIATE](#) on page 89.

Usage: Event

INITiate:SEQuencer:IMMediate

This command starts a new sequence of measurements by the Sequencer.

Before this command can be executed, the Sequencer must be activated (see [SYSTem:SEQuencer](#) on page 90).

Example:

```
SYST:SEQ ON
Activates the Sequencer.
INIT:SEQ:MODE SING
Sets single sequence mode so each active measurement is performed once.
INIT:SEQ:IMM
Starts the sequential measurements.
```

INITiate:SEQuencer:MODE <Mode>

Defines the capture mode for the entire measurement sequence and all measurement groups and channels it contains.

Note: To synchronize to the end of a measurement sequence using *OPC, *OPC? or *WAI, use `SINGLE` Sequencer mode.

Parameters:

<Mode>

SINGLE

Each measurement group is started one after the other in the order of definition. All measurement channels in a group are started simultaneously and performed once. After *all* measurements are completed, the next group is started. After the last group, the measurement sequence is finished.

CONTInuous

Each measurement group is started one after the other in the order of definition. All measurement channels in a group are started simultaneously and performed once. After *all* measurements are completed, the next group is started. After the last group, the measurement sequence restarts with the first one and continues until it is stopped explicitly.

```
*RST:    CONTInuous
```

[SENSe:]SWEep:FHDecade

This command stops the measurement in the current half decade and continues measuring in the subsequent half decade.

Example:

```
SWE:FHD
Aborts the current measurement and continues in the next half decade.
```

Manual operation: See "[Finish Half Decade](#)" on page 51

SYSTem:SEQuencer <State>

This command turns the Sequencer on and off. The Sequencer must be active before any other Sequencer commands (`INIT:SEQ...`) are executed, otherwise an error occurs.

A detailed programming example is provided in the "Operating Modes" chapter in the R&S FPL1000 User Manual.

Parameters:

<State>

ON | OFF | 0 | 1

ON | 1

The Sequencer is activated and a sequential measurement is started immediately.

OFF | 0

The Sequencer is deactivated. Any running sequential measurements are stopped. Further Sequencer commands (`INIT:SEQ...`) are not available.

*RST: 0

Example:

SYST:SEQ ON

Activates the Sequencer.

INIT:SEQ:MODE SING

Sets single Sequencer mode so each active measurement is performed once.

INIT:SEQ:IMM

Starts the sequential measurements.

SYST:SEQ OFF

8.5 Configuring the result display

The commands required to configure the screen display in a remote environment are described here.

- [General window commands](#).....90
- [Working with windows in the display](#).....91

8.5.1 General window commands

The following commands are required to configure general window layout, independent of the application.

`DISPlay[:WINDow<n>]:SIZE`..... 91

DISPlay[:WINDow<n>]:SIZE <Size>

This command maximizes the size of the selected result display window *temporarily*. To change the size of several windows on the screen permanently, use the `LAYout:SPL` command (see `LAYout:SPLitter` on page 94).

Suffix:

<n> [Window](#)

Parameters:

<Size>

LARGE

Maximizes the selected window to full screen.
Other windows are still active in the background.

SMALI

Reduces the size of the selected window to its original size.
If more than one measurement window was displayed originally, these are visible again.

*RST: SMALI

Example:

DISP:WIND2:SIZE LARG

8.5.2 Working with windows in the display

The following commands are required to change the evaluation type and rearrange the screen layout for a channel setup as you do using the SmartGrid in manual operation. Since the available evaluation types depend on the selected application, some parameters for the following commands also depend on the selected channel setup.

Note that the suffix <n> always refers to the window *in the currently selected channel setup*.

LAYout:ADD[:WINDow]?	91
LAYout:CATalog[:WINDow]?	92
LAYout:IDENtify[:WINDow]?	93
LAYout:MOVE[:WINDow]	93
LAYout:REMOve[:WINDow]	94
LAYout:REPLace[:WINDow]	94
LAYout:SPLitter	94
LAYout:WINDow<n>:ADD?	96
LAYout:WINDow<n>:IDENtify?	96
LAYout:WINDow<n>:REMOve	97
LAYout:WINDow<n>:REPLace	97

LAYout:ADD[:WINDow]? <WindowName>, <Direction>, <WindowType>

This command adds a window to the display in the active channel setup.

This command is always used as a query so that you immediately obtain the name of the new window as a result.

To replace an existing window, use the `LAYout:REPLace[:WINDow]` command.

Query parameters:

<WindowName>	String containing the name of the existing window the new window is inserted next to. By default, the name of a window is the same as its index. To determine the name and index of all active windows, use the LAYout:CATalog[:WINDow]? query .
<Direction>	LEFT RIGHT ABOVE BELOW Direction the new window is added relative to the existing window.
<WindowType>	text value Type of result display (evaluation method) you want to add. See the table below for available parameter values.

Return values:

<NewWindowName>	When adding a new window, the command returns its name (by default the same as its number) as a result.
-----------------	---

Example:

```
LAY:ADD? '1', LEFT, MTAB
```

Result:

```
'2'
```

Adds a new window named '2' with a marker table to the left of window 1.

Usage:

Query only

Table 8-3: <WindowType> parameter values for Phase Noise application

Parameter value	Window type
FDRift	Frequency drift
MTABle	Marker table
PNOise	Phase noise diagram
RNOise	Residual noise table
SNOise	Spot noise table
SPECtrum	Spectrum monitor
SPURs	Spur list
SRESults	Sweep result list
STABility	Frequency and level stability indicator

LAYout:CATalog[:WINDow]?

This command queries the name and index of all active windows in the active channel setup from top left to bottom right. The result is a comma-separated list of values for each window, with the syntax:

```
<WindowName_1>,<WindowIndex_1>..<WindowName_n>,<WindowIndex_n>
```

Return values:

<WindowName> string
Name of the window.
In the default state, the name of the window is its index.

<WindowIndex> **numeric value**
Index of the window.

Example:

LAY:CAT?

Result:

'2',2,'1',1

Two windows are displayed, named '2' (at the top or left), and '1' (at the bottom or right).

Usage: Query only

LAYout:IDENTify[:WINDow]? <WindowName>

This command queries the **index** of a particular display window in the active channel setup.

Note: to query the **name** of a particular window, use the `LAYout:WINDow<n>:IDENTify?` query.

Query parameters:

<WindowName> String containing the name of a window.

Return values:

<WindowIndex> Index number of the window.

Example:

LAY:IDEN:WIND? '2'

Queries the index of the result display named '2'.

Response:

2

Usage: Query only

LAYout:MOVE[:WINDow] <WindowName>, <WindowName>, <Direction>**Setting parameters:**

<WindowName> String containing the name of an existing window that is to be moved.
By default, the name of a window is the same as its index. To determine the name and index of all active windows in the active channel setup, use the `LAYout:CATalog[:WINDow]?` query.

<WindowName> String containing the name of an existing window the selected window is placed next to or replaces.
By default, the name of a window is the same as its index. To determine the name and index of all active windows in the active channel setup, use the `LAYout:CATalog[:WINDow]?` query.

<Direction>	LEFT RIGHT ABOVE BELOW REPLACE Destination the selected window is moved to, relative to the reference window.
Example:	LAY:MOVE '4', '1', LEFT Moves the window named '4' to the left of window 1.
Example:	LAY:MOVE '1', '3', REPL Replaces the window named '3' by window 1. Window 3 is deleted.
Usage:	Setting only

LAYout:REMove[:WINDow] <WindowName>

This command removes a window from the display in the active channel.

Setting parameters:

<WindowName> String containing the name of the window. In the default state, the name of the window is its index.

Example: LAY:REM '2'
Removes the result display in the window named '2'.

Usage: Setting only

LAYout:REPLace[:WINDow] <WindowName>, <WindowType>

This command replaces the window type (for example from "Diagram" to "Result Summary") of an already existing window in the active channel setup while keeping its position, index and window name.

To add a new window, use the [LAYout:ADD\[:WINDow\]?](#) command.

Setting parameters:

<WindowName> String containing the name of the existing window.
By default, the name of a window is the same as its index. To determine the name and index of all active windows in the active channel setup, use the [LAYout:CATalog\[:WINDow\]?](#) query.

<WindowType> Type of result display you want to use in the existing window.
See [LAYout:ADD\[:WINDow\]?](#) on page 91 for a list of available window types.

Example: LAY:REPL:WIND '1', MTAB
Replaces the result display in window 1 with a marker table.

Usage: Setting only

LAYout:SPLitter <Index1>, <Index2>, <Position>

This command changes the position of a splitter and thus controls the size of the windows on each side of the splitter.

Note that windows must have a certain minimum size. If the position you define conflicts with the minimum size of any of the affected windows, the command does not work, but does not return an error.

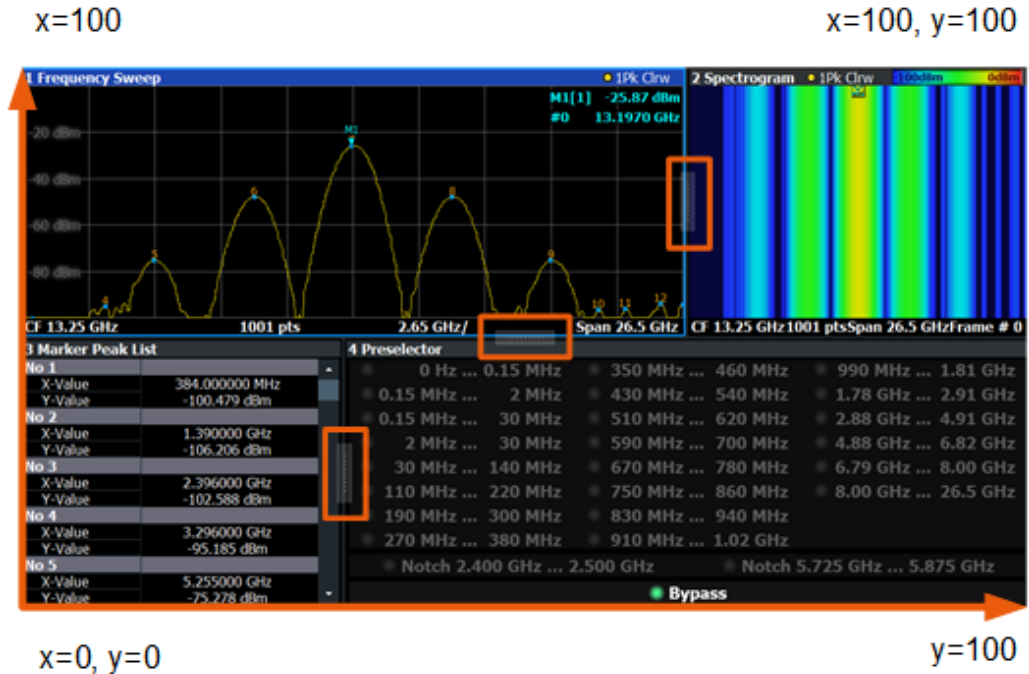

Figure 8-1: SmartGrid coordinates for remote control of the splitters

Setting parameters:

- <Index1> The index of one window the splitter controls.
- <Index2> The index of a window on the other side of the splitter.
- <Position> New vertical or horizontal position of the splitter as a fraction of the screen area (without channel and status bar and softkey menu).
The point of origin ($x = 0$, $y = 0$) is in the lower left corner of the screen. The end point ($x = 100$, $y = 100$) is in the upper right corner of the screen. (See [Figure 8-1](#).)
The direction in which the splitter is moved depends on the screen layout. If the windows are positioned horizontally, the splitter also moves horizontally. If the windows are positioned vertically, the splitter also moves vertically.
- Range: 0 to 100

Example:

```
LAY:SPL 1,3,50
```

Moves the splitter between window 1 ('Frequency Sweep') and 3 ('Marker Table') to the center (50%) of the screen, i.e. in the figure above, to the left.

Example: `LAY:SPL 1,4,70`
 Moves the splitter between window 1 ('Frequency Sweep') and 3 ('Marker Peak List') towards the top (70%) of the screen. The following commands have the exact same effect, as any combination of windows above and below the splitter moves the splitter vertically.

`LAY:SPL 3,2,70`
`LAY:SPL 4,1,70`
`LAY:SPL 2,1,70`

Usage: Setting only

LAYout:WINDow<n>:ADD? <Direction>,<WindowType>

This command adds a measurement window to the display. Note that with this command, the suffix <n> determines the existing window next to which the new window is added. Unlike [LAYout:ADD\[:WINDow\]?](#), for which the existing window is defined by a parameter.

To replace an existing window, use the [LAYout:WINDow<n>:REPLace](#) command.

This command is always used as a query so that you immediately obtain the name of the new window as a result.

Suffix:

<n> [Window](#)

Query parameters:

<Direction> LEFT | RIGHT | ABOVE | BELOW

<WindowType> Type of measurement window you want to add.
 See [LAYout:ADD\[:WINDow\]?](#) on page 91 for a list of available window types.

Return values:

<NewWindowName> When adding a new window, the command returns its name (by default the same as its number) as a result.

Example: `LAY:WIND1:ADD? LEFT,MTAB`
Result:
`'2'`
 Adds a new window named '2' with a marker table to the left of window 1.

Usage: Query only

LAYout:WINDow<n>:IDENTify?

This command queries the **name** of a particular display window (indicated by the <n> suffix) in the active channel setup.

Note: to query the **index** of a particular window, use the [LAYout:IDENTify\[:WINDow\]?](#) command.

Suffix:	
<n>	Window
Return values:	
<WindowName>	String containing the name of a window. In the default state, the name of the window is its index.
Example:	LAY:WIND2:IDEN? Queries the name of the result display in window 2. Response: '2'
Usage:	Query only

LAYout:WINDow<n>:REMove

This command removes the window specified by the suffix <n> from the display in the active channel setup.

The result of this command is identical to the [LAYout:REMove\[:WINDow\]](#) command.

Suffix:	
<n>	Window
Example:	LAY:WIND2:REM Removes the result display in window 2.
Usage:	Event

LAYout:WINDow<n>:REPLace <WindowType>

This command changes the window type of an existing window (specified by the suffix <n>) in the active channel setup.

The effect of this command is identical to the [LAYout:REPLace\[:WINDow\]](#) command.

To add a new window, use the [LAYout:WINDow<n>:ADD?](#) command.

Suffix:	
<n>	Window
Setting parameters:	
<WindowType>	Type of measurement window you want to replace another one with. See LAYout:ADD[:WINDow]? on page 91 for a list of available window types.
Example:	LAY:WIND2:REPL MTAB Replaces the result display in window 2 with a marker table.
Usage:	Setting only

8.6 Configuring the frontend

The following commands are necessary to configure the frontend settings.

[SENSe:]FREQuency:CENTer.....	98
[SENSe:]POWer:RLEVel.....	98
INPut<ip>:ATTenuation.....	98
INPut<ip>:ATTenuation:AUTO.....	99

[SENSe:]FREQuency:CENTer <Frequency>

This command defines the nominal frequency.

Parameters:

<Frequency> Range: 0 to f_{max}
 *RST: f_{max}/2
 Default unit: HZ
 f_{max} is specified in the data sheet. min span is 10 Hz

Example: FREQ:CENT 100 MHz
 Defines a nominal frequency of 100 MHz.

Manual operation: See "[Nominal Frequency](#)" on page 41

[SENSe:]POWer:RLEVel <Power>

This command defines the nominal level.

Parameters:

<Power> Range: -200 to 200
 *RST: 0
 Default unit: DBM

Example: POW:RLEV -20
 Defines a nominal level of -20 dBm.

INPut<ip>:ATTenuation <Attenuation>

This command defines the total attenuation for RF input.

If you set the attenuation manually, it is no longer coupled to the reference level, but the reference level is coupled to the attenuation. Thus, if the current reference level is not compatible with an attenuation that has been set manually, the command also adjusts the reference level.

Suffix:

<ip> 1 | 2
 irrelevant

Parameters:

<Attenuation> Range: see data sheet
 Increment: 5 dB (with optional electr. attenuator: 1 dB)
 *RST: 10 dB (AUTO is set to ON)
 Default unit: DB

Example:

INP:ATT 30dB
 Defines a 30 dB attenuation and decouples the attenuation from the reference level.

Manual operation: See "[Mechanical Attenuator / Value](#)" on page 41

INPut<ip>:ATTenuation:AUTO <State>

This command couples or decouples the attenuation to the reference level. Thus, when the reference level is changed, the R&S FPL1000 determines the signal level for optimal internal data processing and sets the required attenuation accordingly.

For the R&S FPL1000, these commands are identical.

Suffix:

<ip> 1 | 2
 irrelevant

Parameters:

<State> ON | OFF | 0 | 1
 *RST: 1

Example:

INP:ATT:AUTO ON
 Couples the attenuation to the reference level.

Manual operation: See "[Mechanical Attenuator / Value](#)" on page 41

8.7 Controlling the measurement

The following commands are necessary to control the sequence of the phase noise measurement.

[SENSe:]FREQUENCY:TRACk.....	100
[SENSe:]FREQUENCY:VERify:TOLerance:ABSolute.....	100
[SENSe:]FREQUENCY:VERify:TOLerance[:RELative].....	100
[SENSe:]FREQUENCY:VERify[:STATe].....	100
[SENSe:]IQ:DECimation.....	101
[SENSe:]IQ:DPLL.....	101
[SENSe:]IQ:ONLine.....	101
[SENSe:]IQ:TBW.....	102
[SENSe:]POWER:RLEVel:VERify:TOLerance.....	102
[SENSe:]POWER:RLEVel:VERify[:STATe].....	102
[SENSe:]POWER:TRACk.....	103
[SENSe:]REJect:AM.....	103
[SENSe:]SWEep:SVFailed.....	103

[SENSe:]FREQuency:TRACk <State>

This command turns frequency tracking on and off.

Parameters:

<State> ON | OFF | 1 | 0
 *RST: 1

Example: `FREQ:TRAC OFF`
 Turns off frequency tracking.

Manual operation: See "[Frequency Tracking](#)" on page 43

[SENSe:]FREQuency:VERify:TOLerance:ABSolute <Frequency>

This command defines an absolute frequency tolerance for frequency verification.

If you define both an absolute and relative tolerance, the application uses the higher tolerance level.

Parameters:

<Frequency> Numeric value in Hz.
 Default unit: HZ

Example: `FREQ:VER:TOL:ABS 100kHz`
 Defines a frequency tolerance range of 100 kHz.

Manual operation: See "[Verify Frequency](#)" on page 42

[SENSe:]FREQuency:VERify:TOLerance[:RELative] <Percentage>

This command defines a relative frequency tolerance for frequency verification.

If you define both an absolute and relative tolerance, the application uses the higher tolerance level.

Parameters:

<Percentage> Numeric value in %, relative to the current nominal frequency.
 Range: 1 to 100
 *RST: 10
 Default unit: PCT

Example: `FREQ:VER:TOL:REL 12`
 Defines a frequency tolerance of 12% in relation to the nominal frequency.

Manual operation: See "[Verify Frequency](#)" on page 42

[SENSe:]FREQuency:VERify[:STATe] <State>

This command turns frequency verification on and off.

Parameters:

<State> ON | OFF | 1 | 0
 *RST: 1

Example:

FREQ:VER ON
 Turns on frequency verification.

Manual operation: See "[Verify Frequency](#)" on page 42

[SENSe:]IQ:DECimation <State>

This command turns decimation of results on and off.

Parameters:

<State> ON | OFF | 1 | 0
 *RST: 1

Example:

IQ:DEC ON
 Turns on decimation.

Manual operation: See "[Decimation](#)" on page 44

[SENSe:]IQ:DPLL <State>

This command turns the digital PLL on and off.

Parameters:

<State> ON | OFF | 1 | 0

Example:

IQ:DPLL ON
 Turns the digital PLL on.

Manual operation: See "[Digital PLL](#)" on page 44

[SENSe:]IQ:ONLine <State>

This command turns the I/Q online measurement mode on and off.

This mode is available for offset frequencies smaller than 30 kHz.

Note that you have to

- turn on decimation with [\[SENSe:\]IQ:DECimation](#)
- select the I/Q FFT mode for the affected half decades with [\[SENSe:\]LIST:BWIDth\[:RESolution\]:TYPE](#)
- turn off forward sweep with [\[SENSe:\]SWEep:FORward](#)

Parameters:

<State> ON | OFF | 1 | 0

Example:

```
SWE:FORW OFF
LIST:RANG9:FILT:TYPE IQFF
LIST:RANG8:FILT:TYPE IQFF
IQ:DEC ON
IQ:ONL ON
```

Configures a online measurement for the half decades between 3 kHz and 10 kHz and 10 kHz and 30 kHz.

Manual operation: See ["Online I/Q"](#) on page 45

[SENSe:]IQ:TBW <Bandwidth>

This command defines the maximum tracking bandwidth (sample rate) for all half decades.

Parameters:

<Bandwidth> Range: 60 mHz to 65.28 MHz
 Increment: 10 mHz
 *RST: 60 mHz
 Default unit: HZ

Example:

```
IQ:TBW 100HZ
```

Defines a tracking bandwidth of 100 Hz.

Manual operation: See ["Max Freq Drift"](#) on page 44

[SENSe:]POWer:RLEVel:VERify:TOLerance <Level>

This command defines a relative level tolerance for level verification

Parameters:

<Level> Numeric value in dB, relative to the nominal level.
 *RST: 10 dB
 Default unit: DB

Example:

```
POW:RLEV:TOL 5
```

Defines a level tolerance of 5 dB.

Manual operation: See ["Verify Level"](#) on page 43

[SENSe:]POWer:RLEVel:VERify[:STATe] <State>

This command turns level verification on and off.

Parameters:

<State> ON | OFF | 1 | 0
 *RST: 1

Example:

```
POW:RLEV:VER ON
```

Turns on level verification.

Manual operation: See ["Nominal Level"](#) on page 41
 See ["Verify Level"](#) on page 43
 See ["Level Tracking"](#) on page 44

[SENSe:]POWer:TRACk <State>

Parameters:
 <State>

[SENSe:]REJect:AM <State>

This command turns the suppression of AM noise on and off.

Parameters:
 <State> ON | OFF | 1 | 0

Example: REJ:AM ON
 Turns AM noise suppression on.

Manual operation: See ["AM Rejection"](#) on page 44

[SENSe:]SWEep:SVFailed <State>

This command turns repeated tries to start the measurement if signal verification fails on and off.

Parameters:
 <State> ON | OFF | AUTO

If on, the application tries to verify the signal once and then aborts the measurement if verification has failed.

*RST: 0

Example: SWE:SVF ON
 Stops the measurement if signal verification has failed.

Manual operation: See ["On Verify Failed"](#) on page 43

8.8 Configuring the measurement range

The following commands are necessary to configure the phase noise measurement range.

Table 8-4: <range> suffix assignment

Suffix	Half Decade
1	1 Hz ... 3 Hz
2	3 Hz ... 10 Hz
3	10 Hz ... 30 Hz

Suffix	Half Decade
4	30 Hz ... 100 Hz
5	100 Hz ... 300 Hz
6	300 Hz ... 1 kHz
7	1 kHz ... 3 kHz
8	3 kHz ... 10 kHz
9	10 kHz ... 30 kHz
10	30 kHz ... 100 kHz
11	100 kHz ... 300 kHz
12	300 kHz ... 1 MHz
13	1 MHz ... 3 MHz
14	3 MHz ... 10 MHz
15	10 MHz ... 30 MHz
16	30 MHz ... 100 MHz
17	100 MHz ... 300 MHz
18	300 MHz ... 1 GHz
19	1 GHz ... 3 GHz
20	3 GHz ... 10 GHz
21	10 GHz ... 30 GHz
22	30 GHz ... 100 GHz

[SENSe:]LIST:BWIDth[:RESolution]:RATio.....	104
[SENSe:]FREQuency:STARt.....	105
[SENSe:]FREQuency:STOP.....	105
[SENSe:]LIST:BWIDth[:RESolution]:TYPE.....	105
[SENSe:]LIST:RANGe<range>:BWIDth[:RESolution].....	106
[SENSe:]LIST:RANGe<range>:FILTer:TYPE.....	106
[SENSe:]LIST:RANGe<range>:IQWindow:TYPE.....	107
[SENSe:]LIST:RANGe<range>:SWEep:COUNT.....	107
[SENSe:]LIST:SWEep:COUNT.....	107
[SENSe:]LIST:SWEep:COUNT:MULTiplier.....	108
[SENSe:]LIST:SWEep:COUNT:MULTiplier:STATe.....	108
[SENSe:]SWEep:FORWard.....	108
[SENSe:]SWEep:MODE.....	109
[SENSe:]SWEep:COUNT.....	109

[SENSe:]LIST:BWIDth[:RESolution]:RATio <Ratio>

This command defines the resolution bandwidth over all half decades.

Parameters:

<Ratio>

Numeric value in %.

The resulting RBW is the percentage of the start frequency of each half decade.

If the resulting RBW is not available, the application rounds to the next available bandwidth.

Range: 1 to 100

*RST: 10

Default unit: PCT

Example:

LIST:BWID:RAT 20

Defines a RBW of 20% of the start frequency of the corresponding half decade.

[SENSe:]FREQuency:STARt <Frequency>

This command defines the start frequency of the measurement range.

Parameters:

<Frequency>

Offset frequencies in half decade steps.

Range: 1 Hz to 100 GHz

*RST: 1 kHz

Default unit: HZ

Example:

FREQ:STAR 10kHz

Defines a start frequency of 10 kHz.

Manual operation: See "[Range Start / Stop](#)" on page 46

[SENSe:]FREQuency:STOP <Frequency>

This command defines the stop frequency of the measurement range.

Parameters:

<Frequency>

Offset frequencies in half decade steps.

Range: 3 Hz to 30 GHz

*RST: 1 MHz

Default unit: HZ

Example:

FREQ:STOP 10MHz

Defines a stop frequency of 10 MHz.

Manual operation: See "[Range Start / Stop](#)" on page 46

[SENSe:]LIST:BWIDth[:RESolution]:TYPE <Mode>

This command selects the sweep mode for all half decades.

Parameters:

<Mode>

NORMal | FFT | IQFFt

NORMAL

Measurement based on spectrum analyzer data.

FFT

Measurement based on spectrum analyzer data. Kept for compatibility to R&S FSV.

*RST: Depends on half decade

Example:

```
LIST:BWID:RES:TYPE IQFF
```

Selects I/Q analysis mode for all half decades.

Manual operation: See "Global Sweep Mode" on page 48

[SENSe:]LIST:RANGe<range>:BWIDth[:RESolution] <RBW>

This command defines the resolution bandwidth for a particular half decade.

Suffix:

<range>

1..n

Selects the half decade.

For the suffix assignment see [Table 8-4](#).

Parameters:

<RBW>

Note that each half decade has a limited range of available bandwidths.

*RST: Depends on the half decade

Default unit: HZ

Example:

```
LIST:RANG9:BWID 100Hz
```

Selects a RBW of 100 Hz for the half decade from 1 kHz to 3 kHz.

Manual operation: See "Global RBW" on page 47
See "Half Decades Configuration Table" on page 48

[SENSe:]LIST:RANGe<range>:FILTer:TYPE <Mode>

This command selects the sweep mode for a particular half decade.

Suffix:

<range>

1..n

Selects the half decade.

For the suffix assignment see [Table 8-4](#).

Parameters:

<Mode>

NORMAL

Measurement based on spectrum analyzer data.

FFT

Measurement based on spectrum analyzer data. Kept for compatibility to R&S FSV.

IQFFt

Measurement based on I/Q data.

*RST: Depends on half decade

Example: LIST:RANG9:FILT:TYPE FFT
Selects FFT analysis for the ninth half decade.

Manual operation: See "[Half Decades Configuration Table](#)" on page 48

[SENSe:]LIST:RANGe<range>:IQWindow:TYPE <WindowFunction>

This command selects the window function for a particular half decade.

Window functions are available for I/Q sweep mode.

Suffix:
<range> 1..n
Selects the half decade.
For the suffix assignment see [Table 8-4](#).

Parameters:
<WindowFunction> RECTangular | GAUSSian | CHEByshev | BHARris | SWEPT
*RST: Depends on the half decade

Example: LIST:RANG:IQW:TYPE BHAR
Selects the Blackman Harris window function for the first half decade.

Manual operation: See "[Global I/Q Window](#)" on page 48
See "[Half Decades Configuration Table](#)" on page 48

[SENSe:]LIST:RANGe<range>:SWEep:COUNT <Measurements>

This command defines the number of measurements included in the averaging for a half decade.

Suffix:
<range> 1..n
Selects the half decade.
For the suffix assignment see [Table 8-4](#).

Parameters:
<Measurements> Range: 1 to 10000
*RST: Depends on the half decade

Example: LIST:RANG9:SWE:COUN 15
Includes 15 measurements in the averaging of the ninth half decade.

Manual operation: See "[Half Decades Configuration Table](#)" on page 48

[SENSe:]LIST:SWEep:COUNT <Averages>

This command defines the number of measurements to be included in the averaging for each and all half decades.

Parameters:

<Averages> Range: 1 to 10000
 *RST: Depends on the half decade.

Example:

LIST:SWE:COUN 20
 Defines 20 averages for all half decades.

Manual operation: See "[Global Average Count](#)" on page 47

[SENSe:]LIST:SWEep:COUNT:MULTIplier <Multiplier>

This command defines a multiplier that is applied to the average count in each half decade.

Before you can use the command you have to turn on the multiplier with [\[SENSe:\]LIST:SWEep:COUNT:MULTIplier](#).

Parameters:

<Multiplier>

Example:

LIST:SWE:COUN:MULT:STAT ON
 LIST:SWE:COUN:MULT 5
 Turns on the multiplier and multiplies the averages by 5.

Manual operation: See "[Multiplier](#)" on page 47

[SENSe:]LIST:SWEep:COUNT:MULTIplier:STATe <State>

This command turns a multiplier that is applied to the average count in each half decade on and off.

Parameters:

<State> ON | OFF | 1 | 0
 *RST: 0

Example:

See [\[SENSe:\]LIST:SWEep:COUNT:MULTIplier:STATe](#) on page 108.

Manual operation: See "[Multiplier](#)" on page 47

[SENSe:]SWEep:FORWard <State>

This command selects the measurement direction.

Specifies the sweep direction. When switched on the sweep direction is from the start frequency to the stop frequency. When switched off the sweep direction is reversed

Parameters:

<State> **ON | 1**
 Measurements in forward direction.
 The measurements starts at the smallest offset frequency.

OFF | 0

Measurement in reverse direction.

The measurement starts at the highest offset frequency.

*RST: 0

Example:

SWE:FORW ON

Selects forward measurements.

Manual operation: See "[Sweep Forward](#)" on page 46

[SENSe:]SWEep:MODE <Mode>

This command selects the type of measurement configuration.

Parameters:

<Mode>

AVERAge

Selects a measurement configuration optimized for quality results.

FAST

Selects a measurement configuration optimized for speed.

NORMal

Selects a balanced measurement configuration.

*RST: NORMal

Manual operation: See "[Presets](#)" on page 47

[SENSe:]SWEep:COUNT <SweepCount>

This command defines the number of sweeps that the application uses to average traces.

In continuous sweep mode, the application calculates the moving average over the average count.

In single sweep mode, the application stops the measurement and calculates the average after the average count has been reached.

Parameters:

<SweepCount>

If you set a sweep count of 0 or 1, the R&S FPL1000 performs one single sweep.

Range: 0 to 200000

*RST: 200

Example:

SWE:COUN 64

Sets the number of sweeps to 64.

INIT:CONT OFF

Switches to single sweep mode.

INIT;*WAI

Starts a sweep and waits for its end.

Manual operation: See "[This is Sweep/Average Count ok?](#)" on page 50

8.9 Using limit lines

The following commands are necessary to set up and configure limit lines.

- [Using phase noise limit lines](#)..... 110
- [Using standard limit lines](#)..... 113
- [Creating and editing standard limit lines](#)..... 117

8.9.1 Using phase noise limit lines

CALCulate<n>:PNLimit:COPY<k>	110
CALCulate:PNLimit:FC1 <Frequency>	110
CALCulate:PNLimit:FC2 <Frequency>	110
CALCulate:PNLimit:FC3 <Frequency>	110
CALCulate:PNLimit:FC4 <Frequency>	110
CALCulate<n>:PNLimit:FC<1 to 5>	110
CALCulate<n>:PNLimit:NOISe	111
CALCulate<n>:PNLimit:TRACe	111
CALCulate<n>:PNLimit:TYPE	111
CALCulate<n>:PNLimit:FAIL?	112
CALCulate<n>:PNLimit:SLOPe<segment>	112

CALCulate<n>:PNLimit:COPY<k>

Creates a new user limit line from the data of a phase noise limit line.

Suffix:

<n> 1..n
 Number of the limit line the phase noise limit line is copied to. An existing limit line in that slot is overwritten.

<k> 1..n

Example: `CALC:PNL:COPY2`
 Copies the phase noise limit line to limit line 3.

Manual operation: See "[Copy to User Limit Line](#)" on page 66

CALCulate:PNLimit:FC1 <Frequency>
CALCulate:PNLimit:FC2 <Frequency>
CALCulate:PNLimit:FC3 <Frequency>
CALCulate:PNLimit:FC4 <Frequency>
CALCulate<n>:PNLimit:FC<1 to 5> <CornerFrequency>

This command sets the corner frequency of a phase noise limit line.

Suffix:

<n> 1..n

<1 to 5> 1 to 5

Parameters:

<CornerFrequency> Default unit: Hz

Manual operation: See ["Range x - Range y"](#) on page 66

CALCulate<n>:PNLimit:NOISe <NoiseLevel>

This command defines the noise floor level of the DUT.

The noise floor level is necessary for the calculation of a phase noise limit line.

Suffix:

<n> 1..n

Parameters:

<NoiseLevel> Range: -200 to 200
*RST: 0
Default unit: dBm/Hz

Example:

CALC:PNL:NOIS -150
Defines a noise floor level of 150 dBm/Hz.

Manual operation: See ["Noise Floor"](#) on page 66

CALCulate<n>:PNLimit:TRACe <Trace>...

This command selects the trace to assign a phase noise limit line to.

Suffix:

<n> 1..n

Parameters:

<Trace> Range: 1 to 6
*RST: -

Example:

CALC:PNL:TRAC 1
Assigns the phase noise limit line to trace 1.

Manual operation: See ["Selected Traces"](#) on page 65

CALCulate<n>:PNLimit:TYPE <Shape>

This command selects the shape of a phase noise limit line.

Suffix:

<n> 1..n

Parameters:

<Shape> NONE | FC1 | FC2 | FC3 | FC4 | FC5

FC1

Limit line defined by the noise floor and 1 corner frequency.

FC2

Limit line defined by the noise floor and 2 corner frequencies.

FC3

Limit line defined by the noise floor and 3 corner frequencies.

FC4

Limit line defined by the noise floor and 4 corner frequencies.

FC5

Limit line defined by the noise floor and 5 corner frequencies.

NONE

No limit line.

*RST: NONE

Example:

CALC:PNL:TYPE FC2

Selects a limit line with 2 corner frequencies.

Manual operation: See "[Phase Noise Limit Line](#)" on page 65

CALCulate<n>:PNLimit:FAIL?

This command queries the limit check results for phase noise limit lines.

Suffix:

<n> 1..n

Return values:

<LimitCheck> **1**
Limit check has passed.

0
Limit check has failed.

Example:

CALC:PNL:FAIL?

Queries the limit check result.

Usage:

Query only

CALCulate<n>:PNLimit:SLOPe<segment> <Slope>

This command defines the slope for a phase noise limit line segment.

Suffix:

<n> 1..n

<segment> 1..n
Selects the limit line segment.

Parameters:

<Slope> Level distance from the left border of the limit line segment to the previous one.

*RST: 10
Default unit: dB

Example:

CALC:PNL:SLOP2 20

Defines a slope of 20 dB for the second limit line segment.

Manual operation: See "[Range x - Range y](#)" on page 66

8.9.2 Using standard limit lines

CALCulate<n>:LIMit:ACTive?	113
CALCulate<n>:LIMit:CLEar[:IMMediate]	113
CALCulate<n>:LIMit:COPY	113
CALCulate<n>:LIMit:DELeTe	114
CALCulate<n>:LIMit:FAIL?	114
CALCulate<n>:LIMit:NAME	115
CALCulate<n>:LIMit:LOWer:STATe	115
CALCulate<n>:LIMit:STATe	115
CALCulate<n>:LIMit:TRACe<t>	116
CALCulate<n>:LIMit:TRACe<t>:CHECK	116
CALCulate<n>:LIMit:UPPer:STATe	117

CALCulate<n>:LIMit:ACTive?

This command queries the names of *all* active limit lines.

Suffix:

<n>	irrelevant
	irrelevant

Return values:

<LimitLines>	String containing the names of all active limit lines in alphabetical order.
--------------	--

Example:

```
CALC:LIM:ACT?
```

Queries the names of all active limit lines.

Usage:

Query only

Manual operation: See "[Visible](#)" on page 67

CALCulate<n>:LIMit:CLEar[:IMMediate]

This command deletes the result of the current limit check.

The command works on *all* limit lines in *all* measurement windows at the same time.

Suffix:

<n>	Window
	irrelevant

Example:

```
CALC:LIM:CLE
```

Deletes the result of the limit check.

CALCulate<n>:LIMit:COPY <Line>

This command copies a limit line.

Suffix:

<n>	Window
-----	------------------------

 [Limit line](#)

Parameters:

<Line> **1 to 8**
number of the new limit line

<name>
String containing the name of the limit line.

Example: `CALC:LIM1:COPY 2`
Copies limit line 1 to line 2.
`CALC:LIM1:COPY 'FM2'`
Copies limit line 1 to a new line named FM2.

Manual operation: See "[New / Edit / Copy To](#)" on page 68

CALCulate<n>:LIMit:DELeTe

This command deletes a limit line.

Suffix:

<n> [Window](#)

 [Limit line](#)

Manual operation: See "[Delete](#)" on page 68

CALCulate<n>:LIMit:FAIL?

This command queries the result of a limit check in the specified window.

To get a valid result, you have to perform a complete measurement with synchronization to the end of the measurement before reading out the result. This is only possible for single sweep mode.

See also [INITiate<n>:CONTinuous](#) on page 87.

Suffix:

<n> [Window](#)

 [Limit line](#)

Return values:

<Result> **0**
PASS
1
FAIL

Example: `INIT;*WAI`
Starts a new sweep and waits for its end.
`CALC2:LIM3:FAIL?`
Queries the result of the check for limit line 3 in window 2.

Usage: Query only

Manual operation: See "[Check Traces](#)" on page 68

CALCulate<n>:LIMit:NAME <Name>

This command selects a limit line that already exists or defines a name for a new limit line.

Suffix:

<n> [Window](#)

 [Limit line](#)

Parameters:

<Name> String containing the limit line name.

*RST: REM1 to REM8 for lines 1 to 8

Manual operation: See ["New / Edit / Copy To"](#) on page 68
See ["Name"](#) on page 69

CALCulate<n>:LIMit:LOWer:STATe <State>

This command turns a lower limit line on and off.

Before you can use the command, you have to select a limit line with [CALCulate<n>:LIMit:NAME](#) on page 115.

Suffix:

<n> irrelevant

 [Limit line](#)

Parameters:

<State> ON | OFF | 0 | 1

OFF | 0

Switches the function off

ON | 1

Switches the function on

Manual operation: See ["Visible"](#) on page 67

CALCulate<n>:LIMit:STATe <State>

This command turns the limit check for a specific limit line on and off.

To query the limit check result, use [CALCulate<n>:LIMit:FAIL?](#).

Note that a new command exists to activate the limit check and define the trace to be checked in one step (see [CALCulate<n>:LIMit:TRACe<t>:CHECK](#) on page 116).

Suffix:

<n> irrelevant

 [Limit line](#)

Parameters:

<State> ON | OFF | 0 | 1

OFF | 0

Switches the function off

ON | 1

Switches the function on

Example:`CALC:LIM:STAT ON`

Switches on the limit check for limit line 1.

Manual operation: See "[Check Traces](#)" on page 68**CALCulate<n>:LIMit:TRACe<t> <TraceNumber>**

This command links a limit line to one or more traces.

Note that this command is maintained for compatibility reasons only. Limit lines no longer need to be assigned to a trace explicitly. The trace to be checked can be defined directly (as a suffix) in the new command to activate the limit check (see [CALCulate<n>:LIMit:TRACe<t>:CHECK](#) on page 116).

Suffix:<n> [Window](#) [Limit line](#)

<t> irrelevant

Example:`CALC:LIM2:TRAC 3`

Assigns limit line 2 to trace 3.

Manual operation: See "[Check Traces](#)" on page 68**CALCulate<n>:LIMit:TRACe<t>:CHECK <State>**

This command turns the limit check for a specific trace on and off.

To query the limit check result, use [CALCulate<n>:LIMit:FAIL?](#).**Suffix:**<n> [Window](#) [Limit line](#)<t> [Trace](#)**Parameters:**

<State> ON | OFF | 0 | 1

OFF | 0

Switches the function off

ON | 1

Switches the function on

Example:`CALC:LIM3:TRAC2:CHEC ON`

Switches on the limit check for limit line 3 on trace 2.

CALCulate<n>:LIMit:UPPer:STATe <State>

This command turns an upper limit line on and off.

Before you can use the command, you have to select a limit line with [CALCulate<n>:LIMit:NAME](#) on page 115.

Suffix:

<n> irrelevant
 [Limit line](#)

Parameters:

<State> ON | OFF | 0 | 1
OFF | 0
Switches the function off
ON | 1
Switches the function on

Manual operation: See "[Visible](#)" on page 67

8.9.3 Creating and editing standard limit lines

CALCulate<n>:LIMit:COMMeNt	117
CALCulate<n>:LIMit:CONTRol[:DATA]	117
CALCulate<n>:LIMit:CONTRol:SHIFt	118
CALCulate<n>:LIMit:LOWer[:DATA]	118
CALCulate<n>:LIMit:LOWer:MODE	119
CALCulate<n>:LIMit:LOWer:SHIFt	119
CALCulate<n>:LIMit:UPPer:MODE	119
CALCulate<n>:LIMit:UPPer[:DATA]	120
CALCulate<n>:LIMit:UPPer:SHIFt	120

CALCulate<n>:LIMit:COMMeNt <Comment>

This command defines a comment for a limit line.

Suffix:

<n> irrelevant
 [Limit line](#)

Parameters:

<Comment> String containing the description of the limit line.

Manual operation: See "[Comment](#)" on page 70

CALCulate<n>:LIMit:CONTRol[:DATA] <LimitLinePoints>

This command defines the horizontal definition points of a limit line.

Suffix:

<n> irrelevant

 [Limit line](#)

Parameters:

<LimitLinePoints> Variable number of x-axis values.
 Note that the number of horizontal values has to be the same as the number of vertical values set with [CALCulate<n>:LIMit:LOWer\[:DATA\]](#) or [CALCulate<n>:LIMit:UPPer\[:DATA\]](#). If not, the R&S FPL1000 either adds missing values or ignores surplus values.
 The unit is Hz.
 *RST: -
 Default unit: HZ

Manual operation: See "[Data Points](#)" on page 70

CALCulate<n>:LIMit:CONTrol:SHIFt <Distance>

This command moves a complete limit line horizontally.

Compared to defining an offset, this command actually changes the limit line definition points by the value you define.

Suffix:

<n> irrelevant

 [Limit line](#)

Parameters:

<Distance> Numeric value.
 The unit depends on the scale of the x-axis.
 Default unit: HZ

Manual operation: See "[Shift X](#)" on page 71

CALCulate<n>:LIMit:LOWer[:DATA] <LimitLinePoints>

This command defines the vertical definition points of a lower limit line.

Suffix:

<n> irrelevant

 [Limit line](#)

Parameters:

<LimitLinePoints> Variable number of level values.
 Note that the number of vertical values has to be the same as the number of horizontal values set with [CALCulate<n>:LIMit:CONTrol\[:DATA\]](#). If not, the R&S FPL1000 either adds missing values or ignores surplus values.
 *RST: Limit line state is OFF
 Default unit: DBM

Manual operation: See "[Data Points](#)" on page 70

CALCulate<n>:LIMit:LOWer:MODE <Mode>

This command selects the vertical limit line scaling.

Suffix:

<n> [Window](#)

 [Limit line](#)

Parameters:

<Mode>

ABSolute

Limit line is defined by absolute physical values.
The unit is variable.

RELative

Limit line is defined by relative values related to the reference level (dB).

*RST: ABSolute

Manual operation: See "[X-Axis](#)" on page 70

CALCulate<n>:LIMit:LOWer:SHIFt <Distance>

This command moves a complete lower limit line vertically.

Compared to defining an offset, this command actually changes the limit line definition points by the value you define.

Suffix:

<n> [Window](#)

 [Limit line](#)

Parameters:

<Distance>

Defines the distance that the limit line moves.

Default unit: DB

Manual operation: See "[Shift Y](#)" on page 71

CALCulate<n>:LIMit:UPPer:MODE <Mode>

This command selects the vertical limit line scaling.

Suffix:

<n> [Window](#)

 [Limit line](#)

Parameters:

<Mode>

ABSolute

Limit line is defined by absolute physical values.
The unit is variable.

RELative

Limit line is defined by relative values related to the reference level (dB).

*RST: ABSolute

Manual operation: See "X-Axis" on page 70

CALCulate<n>:LIMit:UPPer[:DATA] <LimitLinePoints>

This command defines the vertical definition points of an upper limit line.

Suffix:

<n> irrelevant

 [Limit line](#)

Parameters:

<LimitLinePoints> Variable number of level values.

Note that the number of vertical values has to be the same as

the number of horizontal values set with [CALCulate<n>:](#)

[LIMit:CONTRol\[:DATA\]](#). If not, the R&S FPL1000 either adds missing values or ignores surplus values.

*RST: Limit line state is OFF

Default unit: DBM

Manual operation: See "Data Points" on page 70

CALCulate<n>:LIMit:UPPer:SHIFt <Distance>

This command moves a complete upper limit line vertically.

Compared to defining an offset, this command actually changes the limit line definition points by the value you define.

Suffix:

<n> irrelevant

 [Limit line](#)

Parameters:

<Distance> Defines the distance that the limit line moves.

Manual operation: See "Shift Y" on page 71

8.10 Graphical display of phase noise results

The following commands are necessary to set up and configure the graphical phase noise result displays.

CALCulate<n>:MATH<t>[:EXPRession][:DEFine]	121
CALCulate<n>:MATH<t>:STATe	122
DISPlay[:WINDow<n>][:SUBWindow<w>]:TRACe<t>:MODE	122
DISPlay[:WINDow<n>][:SUBWindow<w>]:TRACe<t>:SMOothing:APERture	122
DISPlay[:WINDow<n>][:SUBWindow<w>]:TRACe<t>:SMOothing[:STATe]	123
DISPlay[:WINDow<n>]:TRACe<t>:SMOothing:TYPE	123

DISPlay[:WINDow<n>]:TRACe<t>:SPURs:SUPPResS.....	124
DISPlay[:WINDow<n>][:SUBWIndow<w>]:TRACe<t>[:STATe].....	124
DISPlay[:WINDow<n>]:TRACe<t>:X[:SCALe]:HDECade.....	125
DISPlay[:WINDow<n>]:TRACe<t>:X[:SCALe]:SCOPE.....	125
DISPlay[:WINDow<n>]:TRACe<t>:X[:SCALe]:START.....	126
DISPlay[:WINDow<n>]:TRACe<t>:X[:SCALe]:STOP.....	126
DISPlay[:WINDow<n>]:TRACe<t>:Y[:SCALe].....	126
DISPlay[:WINDow<n>]:TRACe<t>:Y[:SCALe]:AUTO.....	127
DISPlay[:WINDow<n>]:TRACe<t>:Y[:SCALe]:MANual.....	127
DISPlay[:WINDow<n>]:TRACe<t>:Y[:SCALe]:RLEVel.....	128
DISPlay[:WINDow<n>]:TRACe<t>:Y[:SCALe]:RLEVel:LOWer.....	128
DISPlay[:WINDow<n>]:TRACe<t>:Y[:SCALe]:RLEVel:OFFSet.....	129
FORMat:DEXPort:DSEParator.....	129
FORMat:DEXPort:HEADer.....	129
FORMat:DEXPort:TRACes.....	130
FORMat:DIMPort:TRACes.....	130
FORMat:DEXPort:XDIStrib.....	130
MMEMory:LOAD<n>:TRACe.....	131
MMEMory:STORe<n>:TRACe.....	131
[SENSe:]SPURs:SUPPResS.....	131
[SENSe:]SPURs:THReshold.....	132
TRACe<n>:COPY.....	132
TRACe<n>[:DATA].....	132

CALCulate<n>:MATH<t>[:EXPRession][:DEFine] <Expression>

This command selects the mathematical expression for trace mathematics.

Before you can use the command, you have to turn trace mathematics on.

Suffix:

<n>	Window
<t>	irrelevant

Parameters:

<Expression>	(TRACE1-TRACE2) Subtracts trace 2 from trace 1.
	(TRACE1-TRACE3) Subtracts trace 3 from trace 1.
	(TRACE1-TRACE4) Subtracts trace 4 from trace 1.

Example:

```
CALC:MATH:STAT ON
Turns trace mathematics on.
CALC:MATH:EXPR:DEF (TRACE1-TRACE3)
Subtracts trace 3 from trace 1.
```

Manual operation: See "Trace Math Function" on page 61

CALCulate<n>:MATH<t>:STATe <State>

This command turns the trace mathematics on and off.

Suffix:

<n> [Window](#)

<t> irrelevant

Parameters:

<State> ON | OFF | 0 | 1

OFF | 0

Switches the function off

ON | 1

Switches the function on

Example:

```
CALC:MATH:STAT ON
```

Turns on trace mathematics.

Manual operation: See ["Trace Math Function"](#) on page 61
See ["Trace Math Off"](#) on page 61

DISPlay[:WINDow<n>][:SUBWindow<w>]:TRACe<t>:MODE <Mode>

This command selects the trace mode. If necessary, the selected trace is also activated.

Suffix:

<n> [Window](#)

<w> subwindow
Not supported by all applications

<t> [Trace](#)

Example:

```
INIT:CONT OFF
```

Switching to single sweep mode.

```
SWE:COUN 16
```

Sets the number of measurements to 16.

```
DISP:TRAC3:MODE WRIT
```

Selects clear/write mode for trace 3.

```
INIT;*WAI
```

Starts the measurement and waits for the end of the measurement.

Manual operation: See ["Trace Mode"](#) on page 57

DISPlay[:WINDow<n>][:SUBWindow<w>]:TRACe<t>:SMOothing:APERture <Aperture>

This command defines the degree (aperture) of the trace smoothing, if [DISPlay\[:WINDow<n>\]\[:SUBWindow<w>\]:TRACe<t>:SMOothing\[:STATe\]](#) TRUE.

Suffix:

<n> [Window](#)

<w> subwindow

<t> [Trace](#)

Parameters:

<Aperture> Range: 1 to 50
*RST: 2
Default unit: PCT

Example:

DISP3:TRAC2:SMO:APER 5
Defines an aperture of 5% for trace 2 in window 3

Manual operation: See "[Smoothing](#)" on page 57

DISPlay[:WINDow<n>][:SUBWIndow<w>]:TRACe<t>:SMOothing[:STATe] <State>

This command turns trace smoothing for a particular trace on and off.

If enabled, the trace is smoothed by the value specified using [DISPlay\[:WINDow<n>\]\[:SUBWIndow<w>\]:TRACe<t>:SMOothing:APERture](#) on page 122.

Suffix:

<n> [Window](#)

<w> subwindow

<t> [Trace](#)

Parameters:

<State> ON | OFF | 0 | 1
OFF | 0
Switches the function off
ON | 1
Switches the function on

Example:

DISP3:TRAC2:SMO ON
Turns on trace smoothing for trace 2 in window 3

Manual operation: See "[Smoothing](#)" on page 57

DISPlay[:WINDow<n>]:TRACe<t>:SMOothing:TYPE <Type>

This command selects the trace smoothing method.

Suffix:

<n> 1..n

<t> 1..n
[Trace](#)

Parameters:

<Type> LINear | LOGarithmic | MEDian

LINear

Linear smoothing.

LOGarithmic

Logarithmic smoothing.

MEDian

Median smoothing.

*RST: LIN

Example:

```
DISP:TRAC2:SMO:TYPE LIN
Selects linear smoothing for trace 2.
```

DISPlay[:WINDow<n>]:TRACe<t>:SPURs:SUPPRes <State>

This command turns spur removal for a specific trace on and off.

Suffix:

<n> 1..n
Window

<t> 1..n
Trace

Parameters:

<State> ON | OFF | 1 | 0
*RST: OFF

DISPlay[:WINDow<n>][:SUBWindow<w>]:TRACe<t>[:STATe] <State>

This command turns a trace on and off.

The measurement continues in the background.

Suffix:

<n> Window

<w> subwindow
Not supported by all applications

<t> Trace

Parameters:

<State> ON | OFF | 0 | 1
OFF | 0
Switches the function off
ON | 1
Switches the function on

Example:

```
DISP:TRAC3 ON
```

Manual operation: See "[Trace 1/Trace 2/Trace 3/Trace 4/Trace 5/Trace 6](#)" on page 56

DISPlay[:WINDow<n>]:TRACe<t>:X[:SCALe]:HDECade <HalfDecade>

This command selects the half decade to be displayed.

Before you can use the command you have to select the half decade scope for the x-axis with `DISPlay[:WINDow<n>]:TRACe<t>:X[:SCALe]:SCOPE`.

Suffix:

<n> 1..n

<t> 1..n

Parameters:

<HalfDecade> Start offset frequency of the half decade you want to display. Note that the half decade you want to display has to be part of the current measurement range.

Range: 1 Hz to 100 GHz

*RST: Half decade display is off.

Default unit: HZ

Example:

`DISP:TRAC:X:HDEC 1KHZ`

Displays the half decade beginning with 1 kHz.

Manual operation: See "[Half Decade](#)" on page 55

DISPlay[:WINDow<n>]:TRACe<t>:X[:SCALe]:SCOPE <Scope>

This command selects the way the application scales the horizontal axis.

Suffix:

<n> 1..n

<t> 1..n

Parameters:

<Scope> MRANge | HDECades | MANual

MRANge

Shows the complete measurement range.

HDECade

Shows a particular half decade only.

You can select a particular half decade with .

MANual

Shows a custom part of the measurement range.

You can select the start and stop offsets with .

*RST: MRANge

Example:

`DISP:TRAC:X:SCOP MRAN`

Shows the complete measurement range on the x-axis.

Manual operation: See "[X-Axis Scope](#)" on page 55

DISPlay[:WINDow<n>]:TRACe<t>:X[:SCALe]:STARt <StartFrequency>

This command selects the start frequency of the display range.

Before you can use the command you have to select a manual display range for the x-axis with `DISPlay[:WINDow<n>]:TRACe<t>:X[:SCALe]:SCOPE`.

Suffix:

<n> 1..n

<t> 1..n

Parameters:

<StartFrequency> Start offset frequency of a half decade.
Note that the start offset you want to display has to be part of the current measurement range.

Range: 100 mHz to 3 GHz

*RST: Manual display range is OFF

Default unit: HZ

Example: `DISP:TRAC:X:STAR 100HZ`
Defines 100 Hz as the start of the display range.

Manual operation: See "[X-Axis Start / Stop](#)" on page 55

DISPlay[:WINDow<n>]:TRACe<t>:X[:SCALe]:STOP <StopFrequency>

This command selects the stop frequency of the display range.

Before you can use the command you have to select a manual display range for the x-axis with `DISPlay[:WINDow<n>]:TRACe<t>:X[:SCALe]:SCOPE`.

Suffix:

<n> 1..n

<t> 1..n

Parameters:

<StopFrequency> Stop offset frequency of a half decade.
Note that the stop offset you want to display has to be part of the current measurement range.

Range: 300 mHz to 10 GHz

*RST: Manual display range is OFF

Default unit: HZ

Example: `DISP:TRAC:X:STOP 3KHZ`
Defines 3 kHz as the end of the display range.

Manual operation: See "[X-Axis Start / Stop](#)" on page 55

DISPlay[:WINDow<n>]:TRACe<t>:Y[:SCALe] <Range>

This command defines the display range of the y-axis.

Suffix:

<n> 1..n
[Window](#)

<t> irrelevant

Parameters:

<Range> Default unit: dBc / Hz

Manual operation: See "[Top / Range / Bottom](#)" on page 56

DISPlay[:WINDow<n>]:TRACe<t>:Y[:SCALe]:AUTO <Mode>

This command turns automatic scaling of the vertical axis on and off.

Suffix:

<n> 1..n

<t> 1..n

Parameters:

<Mode> **ON**
 Automatic scaling is on.

OFF
 Automatic scaling is off.

ONCE
 Automatic scaling is performed once, then turned off again.

*RST: ON

Example: DISP:WIND2:TRAC:Y:SCAL:AUTO ONCE
 Scales the vertical axis once.

Manual operation: See "[Y Axis Scaling](#)" on page 55

DISPlay[:WINDow<n>]:TRACe<t>:Y[:SCALe]:MANual <Mode>

This command selects the type of manual scaling of the vertical axis.

Suffix:

<n> 1..n

<t> 1..n

Parameters:

<Mode> OFF | TBOTtom | TRANge | BRANge

OFF
 Turns manual scaling of the y-axis off.

TBOTtom
 Scaling based on the values on the bottom and top of the diagram.

BRANge
 Scaling based on the value at the bottom of the diagram and the axis range.

TRANge

Scaling based on the value at the top of the diagram and the axis range.

*RST: ON

Example:

```
DISP:WIND2:TRAC:Y:SCAL:MAN TRAN
```

Scaling of the vertical axis based on the top and the range of the axis.

Manual operation: See "[Y Axis Scaling](#)" on page 55

DISPlay[:WINDow<n>]:TRACe<t>:Y[:SCALE]:RLEVel <Reference>

This command defines the reference value or upper border of the diagram area.

Note that you have to select manual y-axis scaling before you can use the command.

Suffix:

<n> 1..n

<t> 1..n

Parameters:

<Reference> Range: -200 to 0
*RST: -20
Default unit: DBC/HZ

Example:

```
DISP:TRAC:Y:RLEV -50
```

Defines a reference value of -50 dBc/Hz.

Manual operation: See "[Top / Range / Bottom](#)" on page 56

DISPlay[:WINDow<n>]:TRACe<t>:Y[:SCALE]:RLEVel:LOWer <LowerReference>

This command defines the reference value or upper border of the diagram area.

Note that you have to select manual y-axis scaling before you can use the command.

Suffix:

<n> 1..n

<t> 1..n

Parameters:

<LowerReference> Range: -400 to 1
*RST: -120
Default unit: DBC/HZ

Example:

```
DISP:TRAC:Y:RLEV:LOW -100
```

Sets the bottom of the diagram to .100 dBc/Hz.

Manual operation: See "[Top / Range / Bottom](#)" on page 56

DISPlay[:WINDow<n>]:TRACe<t>:Y[:SCALe]:RLEVel:OFFSet <Offset>

This command defines the trace offset.

Suffix:

<n> 1..n

<t> 1..n

Parameters:

<Offset> Range: -200 to 200
 *RST: 0dB
 Default unit: DB

Example: DISP:TRAC:Y:RLEV:OFFS -10
 Defines a trace offset of -10 dB.

Manual operation: See "[Trace Offset](#)" on page 56

FORMat:DEXPort:DSEParator <Separator>

This command selects the decimal separator for data exported in ASCII format.

Parameters:

<Separator> POINT | COMMa

COMMa

Uses a comma as decimal separator, e.g. 4,05.

POINT

Uses a point as decimal separator, e.g. 4.05.

*RST: *RST has no effect on the decimal separator.
 Default is POINT.

Example: FORM:DEXP:DSEP POIN
 Sets the decimal point as separator.

Manual operation: See "[Decimal Separator](#)" on page 60

FORMat:DEXPort:HEADer <State>

If enabled, additional instrument and measurement settings are included in the header of the export file for result data. If disabled, only the pure result data from the selected traces and tables is exported.

Parameters:

<State> ON | OFF | 0 | 1

*RST: 1

Manual operation: See "[Include Instrument & Measurement Settings](#)" on page 59

FORMat:DEXPort:TRACes <Selection>

This command selects the data to be included in a data export file (see [MMEMoRY:STORe<n>:TRACe](#) on page 131).

Parameters:

<Selection> SINGle | ALL

SINGle

Only a single trace is selected for export, namely the one specified by the [MMEMoRY:STORe<n>:TRACe](#) command.

ALL

Selects all active traces and result tables (e.g. "Result Summary", marker peak list etc.) in the current application for export to an ASCII file.

The <trace> parameter for the [MMEMoRY:STORe<n>:TRACe](#) command is ignored.

*RST: SINGle

Manual operation: See "[Export all Traces and all Table Results](#)" on page 59

FORMat:DIMPort:TRACes <Selection>

This command selects the data to be included in a data import file (see [MMEMoRY:LOAD<n>:TRACe](#) on page 131).

Parameters:

<Selection> SINGle | ALL

SINGle

Only a single trace is selected for import, namely the one specified by the [MMEMoRY:LOAD<n>:TRACe](#) on page 131 command.

ALL

Imports several traces at once, overwriting the existing trace data for any active trace in the result display with the same trace number. Data from the import file for currently not active traces is not imported.

The <trace> parameter for the [MMEMoRY:LOAD<n>:TRACe](#) on page 131 command is ignored.

*RST: SINGle

Manual operation: See "[Import All Traces/Import to Trace](#)" on page 60
See "[Import ASCII File to Trace](#)" on page 60

FORMat:DEXPort:XDIStrib <XDistribution>

Defines how the x-values of the trace are determined in the frequency domain.

Parameters:

<XDistribution> STARtstop | BINCentered

BINCentered

The full measurement span is divided by the number of sweep points to obtain *bins*. The x-value of the sweep point is defined as the x-value at the center of the bin (bin/2).

STARTstop

(Default): The x-value of the first sweep point corresponds to the starting point of the full measurement span. The x-value of the last sweep point corresponds to the end point of the full measurement span. All other sweep points are divided evenly between the first and last points.

Example: `FORM:DEXP:XDIS BIN`

Manual operation: See "[X-Value Distribution](#)" on page 60

MMEMory:LOAD<n>:TRACe <Trace>, <FileName>

This command imports trace data from the specified window to an ASCII file.

Suffix:

<n> [Window](#)

Parameters:

<Trace> Number of the trace to be stored
(This parameter is ignored for `FORMat:DIMPort:TRACesALL`).

<FileName> String containing the path and name of the import file.

MMEMory:STORe<n>:TRACe <Trace>, <FileName>

This command exports trace data from the specified window to an ASCII file.

Suffix:

<n> [Window](#)

Parameters:

<Trace> Number of the trace to be stored

<FileName> String containing the path and name of the target file.

Example: `MMEM:STOR1:TRAC 1, 'C:\TEST.ASC'`
Stores trace 1 from window 1 in the file TEST.ASC.

Manual operation: See "[Export Trace to ASCII File](#)" on page 60

[SENSe:]SPURs:SUPPReSS <State>

This command turns spur removal for all traces and windows on and off.

Parameters:

<State> ON | OFF | 1 | 0

Example: `//Remove spurs`
`SPUR:SUPP ON`

Manual operation: See "[Spur Removal / Spur Threshold](#)" on page 57

[SENSe:]SPURs:THReshold <Threshold>

This command defines the level threshold for spur removal.

Parameters:

<Threshold> Range: 0 to 50
 *RST: 0
 Default unit: DB

Example:

SPUR:THR 10
 Defines a spur threshold of 50 dB.

Manual operation: See "[Spur Removal / Spur Threshold](#)" on page 57

TRACe<n>:COPY <TraceNumber>, <TraceNumber>

This command copies data from one trace to another.

Suffix:

<n> [Window](#)

Parameters:

<TraceNumber> **TRACE1 | TRACE2 | TRACE3 | TRACE4 | TRACE5 | TRACE6**
 The first parameter is the destination trace, the second parameter is the source.
 (Note the 'e' in the parameter is required!)

Example:

TRAC:COPY TRACE1, TRACE2
 Copies the data from trace 2 to trace 1.

Manual operation: See "[Copy Trace](#)" on page 58

TRACe<n>[:DATA] <Trace>

This command queries the results of the graphical result displays.

Suffix:

<n> [Window](#)

Parameters:

<Trace> TRACE1 | TRACE2 | TRACE3 | TRACE4 | TRACE5 | TRACE6

Example:

TRAC? TRACE1
 Queries the data of trace 1.

Manual operation: See "[Phase Noise Diagram](#)" on page 16
 See "[Spectrum Monitor](#)" on page 21

8.11 Configure numerical result displays

The following commands are necessary to configure the numerical phase noise result displays.

- [Configuring residual noise measurements](#)..... 133
- [Reading out residual noise results](#)..... 135
- [Configuring spot noise measurements](#)..... 138
- [Reading out the spur list](#)..... 142
- [Reading out measured values](#)..... 143
- [Reading out the sweep result list](#)..... 143

8.11.1 Configuring residual noise measurements

CALCulate<n>:EVALuation:START	133
CALCulate<n>:EVALuation[:STATe]	133
CALCulate<n>:EVALuation:STOP	134
CALCulate<n>:EVALuation:USER<range>:START	134
CALCulate<n>:EVALuation:USER<range>:STOP	134
CALCulate<n>:EVALuation:USER<range>:TRACe	135

CALCulate<n>:EVALuation:START <OffsetFrequency>

This command defines the start point of the residual noise integration range.

Before you can use the command, you have to turn on the measurement range integration with [CALCulate<n>:EVALuation\[:STATe\]](#) on page 133.

Suffix:

<n>	Window
<n>	1..n

Parameters:

<OffsetFrequency> The minimum offset is 1 Hz. The maximum offset depends on the hardware you are using.

*RST: 1 kHz
Default unit: HZ

Example:

CALC:EVAL:STAR 1 kHz
Defines an start point of 1 kHz for the residual noise range.

Manual operation: See "[Meas Range](#)" on page 62
See "[User Range](#)" on page 63

CALCulate<n>:EVALuation[:STATe] <State>

This command turn integration of the measurement range for residual noise calculation on and off.

Suffix:

<n>	Window
-----	------------------------

<n> 1..n

Parameters:

<State>

OFF | 0

Calculates the residual noise over the entire measurement range.

ON | 1

Calculates the residual noise over a customized range.

*RST: 0

Example:

CALC:EVAL ON

Uses a customized offset range for residual noise calculation.

Manual operation: See "[Meas Range](#)" on page 62

CALCulate<n>:EVALuation:STOP <OffsetFrequency>

This command defines the end point of the residual noise integration range.

Before you can use the command, you have to turn on the measurement range integration with [CALCulate<n>:EVALuation\[:STATe\]](#) on page 133.

Suffix:

<n> 1..n
[Window](#)

Parameters:

<OffsetFrequency> The minimum offset is 1 Hz. The maximum offset depends on the hardware you are using.

*RST: 1 MHz

Default unit: HZ

Example:

CALC:EVAL:STOP 1 MHZ

Defines an end point of 1 MHz for the residual noise range.

CALCulate<n>:EVALuation:USER<range>:START <OffsetFrequency>**Suffix:**

<n> 1..n

<range> 1..n

Parameters:

<OffsetFrequency> Default unit: HZ

CALCulate<n>:EVALuation:USER<range>:STOP <OffsetFrequency>

This command defines the end point of a custom residual noise calculation range.

Before you can use the command, you have to assign the user range to a trace with [CALCulate<n>:EVALuation:USER<range>:TRACe](#) on page 135.

Suffix:

<n> 1..n
Window

<range> 1..n

Parameters:

<OffsetFrequency> The minimum offset is 1 Hz. The maximum offset depends on the hardware you are using.

*RST: 1 MHz

Default unit: HZ

Example:

CALC:EVAL:USER2:STOP 100kHz

Defines an end point of 100 kHz for the second user range.

Manual operation: See "Meas Range" on page 62

See "User Range" on page 63

CALCulate<n>:EVALuation:USER<range>:TRACe <Trace>

This command selects the trace for a custom residual noise calculation range.

Suffix:

<n> 1..n
Window

<range> 1..n
Selects the user range.

Parameters:

<Trace> NONE | TRACe1 | TRACe2 | TRACe3 | TRACe4 | TRACe5 | TRACe6

TRACE1 ... TRACE6

Trace to assign the user range to.

NONE

Turns a user range off.

Example:

CALC:EVAL:USER2:TRAC TRACE2

Assigns the second user range to trace 2.

Manual operation: See "User Range" on page 63

8.11.2 Reading out residual noise results

FETCh:PNOise<t>:IPN?	136
FETCh:PNOise<t>:RFM?	136
FETCh:PNOise<t>:RMS?	136
FETCh:PNOise<t>:RPM?	136
FETCh:PNOise<t>:USER<range>:IPN?	137
FETCh:PNOise<t>:USER<range>:RFM?	137
FETCh:PNOise<t>:USER<range>:RMS?	137
FETCh:PNOise<t>:USER<range>:RPM?	138

FETCH:PNOise<t>:IPN?

This command queries the Integrated Phase Noise for the first trace.

Suffix:

<t> 1..n

Example:

FETCH:PNO2:IPN?

Queries the Integrated Phase Noise for the first trace in the diagram.

Usage:

Query only

FETCH:PNOise<t>:RFM?

This command queries the residual FM for the first trace.

Suffix:

<t> 1..n
[Trace](#)

Example:

FETCH:PNO2:RFM?

Queries the residual FM for the first trace in the diagram.

Usage:

Query only

FETCH:PNOise<t>:RMS?

This command queries the residual RMS jitter for the first trace.

Suffix:

<t> 1..n
[Trace](#)

Example:

FETCH:PNO2:RMS?

Queries the RMS jitter for the first trace in the diagram.

Usage:

Query only

FETCH:PNOise<t>:RPM?

This command queries the residual PM for a particular user range.

The trace that is queried depends on [CALCulate<n>:EVALuation:USER<range>:TRACe](#).

Suffix:

<t> 1..n
[Trace](#)

<range>

1...3

Selects the user range.

Example:

FETCH:PNO:USER2:RPM?

Queries the residual PM for user range 2.

Usage: Query only

FETCh:PNOise<t>:USER<range>:IPN?

This command queries the Integrated Phase Noise for a particular user range.

The trace that is queried depends on [CALCulate<n>:EVALuation:USER<range>:TRACe](#).

Suffix:

<t> 1..n
[Trace](#)

<range> 1..n
Selects the user range.

Example: FETC:PNO:USER2:IPN?
Queries the Integrated Phase Noise for user range 2.

Usage: Query only

FETCh:PNOise<t>:USER<range>:RFM?

This command queries the residual FM for a particular user range.

The trace that is queried depends on [CALCulate<n>:EVALuation:USER<range>:TRACe](#).

Suffix:

<t> 1..n
[Trace](#)

<range> 1..n
Selects the user range.

Example: FETC:PNO:USER2:RFM?
Queries the residual FM for user range 2.

Usage: Query only

Manual operation: See ["Residual Noise"](#) on page 17

FETCh:PNOise<t>:USER<range>:RMS?

This command queries the residual RMS jitter for a particular user range.

The trace that is queried depends on [CALCulate<n>:EVALuation:USER<range>:TRACe](#).

Suffix:

<t> 1..n
[Trace](#)

<range> 1..n
Selects the user range.

Example: FETC:PNO:USER2:RMS?
Queries the RMS jitter for user range 2.

Usage: Query only

Manual operation: See "Residual Noise" on page 17

FETCh:PNOise<t>:USER<range>:RPM?

This command queries the residual PM for the first trace.

Suffix:

<t> 1..n
Trace

<range> 1..n

Example: FETC:PNO:RPM?
Queries the residual PM for the first trace of the diagram.

Usage: Query only

Manual operation: See "Residual Noise" on page 17

8.11.3 Configuring spot noise measurements

CALCulate<n>:SNOise<m>:AOFF.....	138
CALCulate<n>:SNOise<m>:DECades[:STATe].....	139
CALCulate<n>:SNOise<m>:DECades:X.....	139
CALCulate<n>:SNOise<m>:DECades:Y.....	139
CALCulate<n>:SNOise<m>[:STATe].....	140
CALCulate<n>:SNOise<m>:X.....	140
CALCulate<n>:SNOise<m>:Y.....	141
DISPlay[:WINDow<n>]:TRACe<t>:SELect.....	141

CALCulate<n>:SNOise<m>:AOFF

This command turns all spot noise markers off (custom and 10^x markers).

Suffix:

<n> 1..n
Window

<m> 1..n

Example: CALC:SNO:AOFF
Turns all spot noise markers off.

Manual operation: See "On User Defined Offsets / Offset Frequency" on page 64

CALCulate<n>:SNOise<m>:DECades[:STATe] <State>

This command turns the spot noise calculation on every 10^x offset frequency on and off.

Suffix:

<n> 1..n
Window

<m> 1..n

Parameters:

<State> ON | OFF | 1 | 0
*RST: 1

Example:

CALC:SNO:DEC ON

Turns the spot noise calculation for each decade start on.

Manual operation:

See "On All Decade Edges" on page 63

See "On User Defined Offsets / Offset Frequency" on page 64

CALCulate<n>:SNOise<m>:DECades:X

This command queries the horizontal position of the 10^x offset frequency spot noise markers.

Suffix:

<n> 1..n
Window

<m> 1..n

Return values:

<OffsetFrequency> List of offset frequencies, one for each 10^x spot noise marker.
The number of return values depends on the measurement range.
Default unit: Hz

Example:

CALC:SNO:DEC:X?

Return values, e.g.:

1000,10000,100000,1000000

Manual operation:

See "Spot Noise" on page 18

See "On All Decade Edges" on page 63

CALCulate<n>:SNOise<m>:DECades:Y

This command queries the vertical position of the 10^x offset frequency spot noise markers.

Suffix:

<n> 1..n
Window

<m> 1..n

Return values:

<Level> List of level values, one for each 10^x spot noise marker. The number of return values depends on the measurement range.
Default unit: dBc/Hz

Example:

CALC:SNO:DEC:Y?

Return values, e.g.:

-152.560974121094, -136.443389892578,
-145.932891845703, -152.560974121094

Manual operation: See "Spot Noise" on page 18
See "On All Decade Edges" on page 63

CALCulate<n>:SNOise<m>[:STATe] <State>

This command turns a custom spot noise marker on and off.

Suffix:

<n> 1..n
[Window](#)

<m> 1..n
Selects the spot noise marker.

Parameters:

<State> ON | OFF | 1 | 0
*RST: All 1

Example:

CALC:SNO3:STATE ON
Turns spot noise marker 3 on.

CALCulate<n>:SNOise<m>:X <OffsetFrequency>

This command defines the horizontal position of a custom spot noise marker.

Suffix:

<n> 1..n
[Window](#)

<m> 1..n
Selects the spot noise marker.

Parameters:

<OffsetFrequency> The minimum offset is 1 Hz. The maximum offset depends on the hardware you are using.
The default value varies for each of the five spot noise markers. For marker 1 it is 1 kHz, for marker 2 it is 10 kHz, for marker 3 it is 100 kHz, for marker 4 it is 1 MHz and for marker 5 it is 10 MHz
Default unit: HZ

Example: `CALC:SNO3:X 2MHz`
Positions the third custom spot noise marker to an offset frequency of 2 MHz.

Manual operation: See ["On User Defined Offsets / Offset Frequency"](#) on page 64

CALCulate<n>:SNOise<m>:Y <Level>

This command queries the vertical position of a custom spot noise marker.

Suffix:

<n> 1..n
[Window](#)

<m> 1..n
Selects the spot noise marker

Parameters:

<Level> Phase noise level at the marker position.
Default unit: dBc/Hz

Example: `CALC:SNO3:Y?`
Queries the level of the third custom spot noise marker.

Manual operation: See ["Spot Noise"](#) on page 18
See ["On User Defined Offsets / Offset Frequency"](#) on page 64

DISPlay[:WINDow<n>]:TRACe<t>:SElect <Trace>

This command selects the trace for which spot noise results are calculated.

A trace can only be selected if it has been turned on ("Trace Mode" ≠ Blank).

Suffix:

<n> 1..n
irrelevant

<t> 1..n
irrelevant

Parameters:

<Trace> Number of the trace you want to select.
Range: 1 to 6
*RST: 1

Example: `DISP:TRAC:SEL 2`
Selects trace number 2.

Manual operation: See ["Spot Noise"](#) on page 18

8.11.4 Reading out the spur list

FETCh:PNOise<t>:SPURs?.....	142
FETCh:PNOise<t>:SPURs:DISCcrete?.....	142
FETCh:PNOise<t>:SPURs:RANDom?.....	142

FETCh:PNOise<t>:SPURs?

This command queries the location and level of all spurs that have been detected.

Suffix:

<t> 1..n

Return values:

<Spurs> Returns two values (frequency and level) for each spur that has been detected.

Example:

FETC:PNO:SPUR?
would return, e.g.
1999.232666,-0.639974,6494.312500,-0.760579,
19992.324219,-0.639974

Usage: Query only

Manual operation: See "[Spur List](#)" on page 19

FETCh:PNOise<t>:SPURs:DISCcrete?

This command queries the Discrete Jitter result.

Suffix:

<t> 1..n

Return values:

<Jitter>

Example:

FETC:PNO:SPUR:DISC?
would return, e.g.
2.3e-08

Usage: Query only

Manual operation: See "[Spur List](#)" on page 19

FETCh:PNOise<t>:SPURs:RANDom?

Suffix:

<t> 1..n

Return values:

<Jitter>

Usage: Query only

Manual operation: See "[Spur List](#)" on page 19

8.11.5 Reading out measured values

FETCh:PNOise<t>:MEASured:FREQUency?	143
FETCh:PNOise<t>:MEASured:LEVel?	143

FETCh:PNOise<t>:MEASured:FREQUency?

This command queries the carrier frequency that has been actually measured.

The measured frequency is shown in the channel bar.

Suffix:

<t> 1..n

Return values:

<Frequency> Frequency in Hz.

Example:

FETC:PNO:MEAS:FREQ?
Queries the measured frequency.

Usage:

Query only

FETCh:PNOise<t>:MEASured:LEVel?

This command queries the level of the DUT that has been actually measured.

The measured level is shown in the channel bar.

Suffix:

<t> 1..n

Return values:

<Level> Level in dBm.

Example:

FETC:PNO:MEAS:LEV?
Queries the measured level.

Usage:

Query only

8.11.6 Reading out the sweep result list

FETCh:PNOise<t>:SWEep:AVG?	143
FETCh:PNOise<t>:SWEep:FDRift?	144
FETCh:PNOise<t>:SWEep:LDRift?	144
FETCh:PNOise<t>:SWEep:MDRift?	145
FETCh:PNOise<t>:SWEep:SRATe?	145
FETCh:PNOise<t>:SWEep:STARt?	145
FETCh:PNOise<t>:SWEep:STOP?	146

FETCh:PNOise<t>:SWEep:AVG?

This command queries the number of measurements that have been performed in each half decade.

Suffix:

<t> 1..n

Return values:

<Measurements> Number of measurements as displayed in the Sweep Result List.
The command returns one value for each half decade as a comma separated list.

Example:

FETCH:PNO:SWE:AVG?
would return, e.g.:
10,10,10,10,10

Usage: Query only**Manual operation:** See "[Sweep Result List](#)" on page 20**FETCH:PNOise<t>:SWEep:FDRift?**

This command queries the frequency drift in each half decade.

Suffix:

<t> 1..n

Return values:

<Frequency> Frequency drift as displayed in the Sweep Result List.
The command returns one value for each half decade as a comma separated list.
Default unit: Hz

Example:

FETCH:PNO:SWE:FDR?
would return, e.g.:
-203.565049124882,-198.254803592339,
-179.608235809952,-126.506989398971,
-95.0386250484735

Usage: Query only**Manual operation:** See "[Sweep Result List](#)" on page 20**FETCH:PNOise<t>:SWEep:LDRift?**

This command queries the level drift in each half decade.

Suffix:

<t> 1..n

Return values:

<Level> Level drift as displayed in the Sweep Result List.
The command returns one value for each half decade as a comma separated list.
Default unit: dB

Example: `FETC:PNO:SWE:LDR?`
 would return, e.g.:
 0.84823463324, 6.55278904401, 1.02393361087,
 2.10021296216, 5.28119567376

Usage: Query only

Manual operation: See "[Sweep Result List](#)" on page 20

FETCh:PNOise<t>:SWEep:MDRift?

This command queries the maximum frequency drift in each half decade.

Suffix:

<t> 1..n

Return values:

<Frequency> Frequency drift as displayed in the Sweep Result List.
 The command returns one value for each half decade as a
 comma separated list.
 Default unit: Hz

Example: `FETC:PNO:SWE:MDR?`
 would return, e.g.:
 2.17, 11.45, 105.11, 219.37, 553.48

Usage: Query only

Manual operation: See "[Sweep Result List](#)" on page 20

FETCh:PNOise<t>:SWEep:SRATE?

This command queries the sampling rate used in each half decade.

Suffix:

<t> 1..n

Return values:

<SamplingRate> Sampling rate as displayed in the Sweep Result List.
 The command returns one value for each half decade as a
 comma separated list.
 Default unit: Hz

Example: `FETC:PNO:SWE:SRAT?`
 would return, e.g.:
 25000, 75000, 250000, 750000, 2500000

Usage: Query only

Manual operation: See "[Sweep Result List](#)" on page 20

FETCh:PNOise<t>:SWEep:STARt?

This command queries the start frequency offset of each half decade.

Suffix:	
<t>	1..n
Return values:	
<Frequency>	Frequency offset as displayed in the Sweep Result List. The command returns one value for each half decade as a comma separated list. Default unit: Hz
Example:	FETC:PNO:SWE:STAR? would return, e.g.: 1000,3000,10000,30000,100000
Usage:	Query only
Manual operation:	See " Sweep Result List " on page 20

FETCh:PNOise<t>:SWEep:STOP?

This command queries the stop frequency offset of each half decade.

Suffix:	
<t>	1..n
Return values:	
<Measurements>	Frequency offset as displayed in the Sweep Result List. The command returns one value for each half decade as a comma separated list. Default unit: Hz
Example:	FETC:PNO:SWE:STOP? would return, e.g.: 3000,10000,30000,100000,300000
Usage:	Query only
Manual operation:	See " Sweep Result List " on page 20

8.12 Using markers

The following commands are necessary to control markers.

- [Using markers](#)..... 147
- [Using delta markers](#)..... 148
- [Configuring markers](#)..... 151
- [Using the marker zoom](#)..... 152

8.12.1 Using markers

CALCulate<n>:MARKer<m>:AOFF.....	147
CALCulate<n>:MARKer<m>[:STATE].....	147
CALCulate<n>:MARKer<m>:TRACe.....	147
CALCulate<n>:MARKer<m>:X.....	148
CALCulate<n>:MARKer<m>:Y.....	148

CALCulate<n>:MARKer<m>:AOFF

This command turns off all markers.

Suffix:

<n>	Window
<m>	Marker

Example:

```
CALC:MARK:AOFF
Switches off all markers.
```

Manual operation: See "[All Markers Off](#)" on page 74

CALCulate<n>:MARKer<m>[:STATE] <State>

This command turns markers on and off. If the corresponding marker number is currently active as a delta marker, it is turned into a normal marker.

Suffix:

<n>	Window
<m>	Marker

Parameters:

<State>	ON OFF 0 1
	OFF 0
	Switches the function off
	ON 1
	Switches the function on

Example:

```
CALC:MARK3 ON
Switches on marker 3.
```

Manual operation: See "[Marker 1 ... Marker x](#)" on page 72
See "[Marker Type](#)" on page 73

CALCulate<n>:MARKer<m>:TRACe <Trace>

This command selects the trace the marker is positioned on.

Note that the corresponding trace must have a trace mode other than "Blank".

If necessary, the command activates the marker first.

Suffix:<n> [Window](#)<m> [Marker](#)**Parameters:**<Trace> **1 to 6**
Trace number the marker is assigned to.**Example:** //Assign marker to trace 1
CALC:MARK3:TRAC 2**Manual operation:** See "[Assigning the Marker to a Trace](#)" on page 73**CALCulate<n>:MARKer<m>:X <Position>**

This command moves a marker to a particular coordinate on the x-axis.

If necessary, the command activates the marker.

If the marker has been used as a delta marker, the command turns it into a normal marker.

Suffix:<n> 1..n
[Window](#)<m> 1..n
[Marker](#)**Parameters:**<Position> Numeric value that defines the marker position on the x-axis.
Default unit: HZ**Example:** CALC:MARK2:X 1.7MHz
Positions marker 2 to frequency 1.7 MHz.**CALCulate<n>:MARKer<m>:Y <Level>****Suffix:**

<n> 1..n

<m> 1..n

Parameters:

<Level>

8.12.2 Using delta markers

CALCulate<n>:DELTaMarker<m>:AOFF	149
CALCulate<n>:DELTaMarker<m>:MREFerence	149
CALCulate<n>:DELTaMarker<m>[:STATE]	149

CALCulate<n>:DELTamarker<m>:TRACe.....	150
CALCulate<n>:DELTamarker<m>:X.....	150
CALCulate<n>:DELTamarker<m>:Y.....	151

CALCulate<n>:DELTamarker<m>:AOFF

This command turns off *all* delta markers.

Suffix:

<n> [Window](#)

<m> irrelevant

Example:

CALC:DELT:AOff
Turns off all delta markers.

CALCulate<n>:DELTamarker<m>:MREFerence <Reference>

This command selects a reference marker for a delta marker other than marker 1.

The reference may be another marker or the fixed reference.

Suffix:

<n> [Window](#)

<m> [Marker](#)

Parameters:

<Reference> **1 to 16**
Selects markers 1 to 16 as the reference.

FIXed

Selects the fixed reference as the reference.

Example:

CALC:DELT3:MREF 2
Specifies that the values of delta marker 3 are relative to marker 2.

Manual operation: See "[Reference Marker](#)" on page 73

CALCulate<n>:DELTamarker<m>[:STATe] <State>

This command turns delta markers on and off.

If necessary, the command activates the delta marker first.

No suffix at DELTmarker turns on delta marker 1.

Suffix:

<n> [Window](#)

<m> [Marker](#)

Parameters:

<State> ON | OFF | 0 | 1

OFF | 0

Switches the function off

ON | 1

Switches the function on

Example:`CALC:DELT2 ON`

Turns on delta marker 2.

Manual operation:See "[Marker 1 ... Marker x](#)" on page 72See "[Marker Type](#)" on page 73**CALCulate<n>:DELTamarker<m>:TRACe <Trace>**

This command selects the trace a delta marker is positioned on.

Note that the corresponding trace must have a trace mode other than "Blank".

If necessary, the command activates the marker first.

Suffix:<n> [Window](#)<m> [Marker](#)**Parameters:**

<Trace> Trace number the marker is assigned to.

Example:`CALC:DELT2:TRAC 2`

Positions delta marker 2 on trace 2.

CALCulate<n>:DELTamarker<m>:X <Position>

This command moves a delta marker to a particular coordinate on the x-axis.

If necessary, the command activates the delta marker and positions a reference marker to the peak power.

Suffix:<n> 1..n
[Window](#)<m> 1..n
[Marker](#)**Parameters:**<Position> The position is relative to the reference marker.
The unit is Hz (offset frequency).
A query returns the absolute position of the delta marker.
Range: The value range depends on the current measurement range.
Default unit: HZ**Example:**`CALC:DELT:X?`

Outputs the absolute frequency/time of delta marker 1.

CALCulate<n>:DELTaMarker<m>:Y <Level>

This command queries the relative position of a delta marker on the y-axis.

If necessary, the command activates the delta marker first.

To get a valid result, you have to perform a complete measurement with synchronization to the end of the measurement before reading out the result. This is only possible for single sweep mode.

See also [INITiate<n>:CONTinuous](#) on page 87.

Suffix:

<n>	1..n Window
<m>	1..n Marker

Parameters:

<Level>	Phase noise level. Default unit: dBc/Hz
---------	--

Example:

```
INIT:CONT OFF
Switches to single sweep mode.
INIT;*WAI
Starts a sweep and waits for its end.
CALC:DELT2 ON
Switches on delta marker 2.
CALC:DELT2:Y?
Outputs measurement value of delta marker 2.
```

8.12.3 Configuring markers

DISPlay[:WINDow<n>]:MINFo[:STATe]	151
DISPlay[:WINDow<n>]:MTABLE	152

DISPlay[:WINDow<n>]:MINFo[:STATe] <State>

This command turns the marker information in all diagrams on and off.

Suffix:

<n>	irrelevant
-----	------------

Parameters:

<State>	ON 1 Displays the marker information in the diagrams. OFF 0 Hides the marker information in the diagrams. *RST: 1
---------	--

Example:

```
DISP:MINF OFF
Hides the marker information.
```

Manual operation: See ["Marker Info"](#) on page 74

DISPlay[:WINDow<n>]:MTABLE <DisplayMode>

This command turns the marker table on and off.

Suffix:

<n> irrelevant

Parameters:

<DisplayMode>

ON | 1

Turns on the marker table.

OFF | 0

Turns off the marker table.

AUTO

Turns on the marker table if 3 or more markers are active.

*RST: AUTO

Example:

DISP:MTAB ON

Activates the marker table.

Manual operation: See ["Marker Table Display"](#) on page 74

8.12.4 Using the marker zoom

[CALCulate<n>:MARKer<m>:FUNction:ZOOM](#)..... 152

[DISPlay\[:WINDow<n>\]:ZOOM\[:STATe\]](#)..... 152

CALCulate<n>:MARKer<m>:FUNction:ZOOM <ZoomFactor>

This command defines the factor or magnitude of the marker zoom.

Suffix:

<n> 1..n

<m> 1..n

Parameters:

<ZoomFactor>

Range: 1 to 20

*RST: Zoom OFF

Example:

CALC:MARK:FUNC:ZOOM 12

Zooms into the diagram with a factor of 10 around marker 1.

Manual operation: See ["Marker Zoom"](#) on page 73

DISPlay[:WINDow<n>]:ZOOM[:STATe] <State>

This command turns the marker zoom for marker 1 on and off.

Suffix:

<n> 1..n

Parameters:

<State> ON | OFF | 1 | 0
 *RST: 0

Example:

DISP:ZOOM ON
 Turns on the marker zoom.

Manual operation: See "[Marker Zoom](#)" on page 73

8.13 Configuring in- and outputs

The following commands are necessary to configure the frontend settings.

INPut<ip>:COUPLing.....	153
INPut<ip>:DPATH.....	153
INPut<ip>:FILTer:YIG[:STATe].....	154
INPut<ip>:CONNector.....	154

INPut<ip>:COUPLing <CouplingType>

This command selects the coupling type of the RF input.

Suffix:

<ip> 1 | 2
 irrelevant

Parameters:

<CouplingType> AC | DC
AC
 AC coupling
DC
 DC coupling
 *RST: AC

Example:

INP:COUP DC

Manual operation: See "[Coupling](#)" on page 42

INPut<ip>:DPATH <DirectPath>

Enables or disables the use of the direct path for frequencies close to 0 Hz.

Suffix:

<ip> 1 | 2
 irrelevant

Parameters:

<DirectPath> AUTO | OFF
AUTO | 1
 (Default) the direct path is used automatically for frequencies close to 0 Hz.

OFF | 0

The analog mixer path is always used.

Example: `INP:DPAT OFF`

INPut<ip>:FILTer:YIG[:STATe] <State>

Enables or disables the YIG filter.

Suffix:

<ip> 1 | 2
irrelevant

Parameters:

<State> ON | OFF | 0 | 1

Example: `INP:FILT:YIG OFF`
Deactivates the YIG-preselector.

INPut<ip>:CONNector <ConnType>

Determines which connector the input for the measurement is taken from.

Suffix:

<ip> 1 | 2
irrelevant

Parameters:

<ConnType> **RF**
RF input connector
RFProbe
Active RF probe
***RST: RF**

Example: `INP:CONN RF`
Selects input from the RF input connector.

8.14 Independant CW source commands

The following commands are required to configure an internal generator as an independant CW source.

<code>OUTPut<up>[:STATe]</code>	155
<code>SOURce<si>:INTerNal:FREQUency</code>	155
<code>SOURce<si>:POWer[:LEVel][:IMMediate][:AMPLitude]</code>	155
<code>SOURce<si>:POWer[:LEVel][:IMMediate]:OFFSet</code>	156

OUTPut<up>[:STATe] <State>

Enables or disables the internal generator. The generator signal is output at the GEN Output 50 Ω connector on the front panel.

Suffix:

<up>

Parameters:

<State> ON | OFF | 0 | 1
OFF | 0
 Switches the function off
ON | 1
 Switches the function on
 *RST: 0

Example: OUTP ON

Manual operation: See "[State](#)" on page 52

SOURce<si>:INTernal:FREQuency <Frequency>

Defines the frequency of the internal generator signal.

Suffix:

<si> irrelevant

Parameters:

<Frequency> Range: 5 kHz to 3 GHz
 Increment: 0.1 Hz
 *RST: 1 GHz
 Default unit: HZ

Example: SOUR:INT:FREQ 2 GHz

Manual operation: See "[CW Frequency](#)" on page 52

SOURce<si>:POWER[:LEVel][:IMMEDIATE][:AMPLitude] <Amplitude>

Defines the output power of the internal generator.

Suffix:

<si> irrelevant

Parameters:

<Amplitude> Range: -60 dBm to +10 dBm
 Increment: 0.1 dB
 *RST: -20 dBm
 Default unit: DBM

Example: SOUR:POW -30dBm

Manual operation: See "[Level](#)" on page 52

SOURce<si>:POWER[:LEVel][:IMMediate]:OFFSet <Offset>

This command defines a level offset for the internal generator level. Thus, for example, attenuators or amplifiers at the output of the internal generator can be considered for the setting.

Suffix:

<si> irrelevant

Parameters:

<Offset> Range: -200 dB to +200 dB
 *RST: 0dB
 Default unit: DB

Example: SOUR:POW:OFFS -10dB

Manual operation: See "[Level Offset](#)" on page 52

8.15 Automatic measurement configuration

The following commands are necessary to determine measurement parameters automatically.

[SENSe:]ADJust:ALL	156
[SENSe:]ADJust:FREQuency	156
[SENSe:]ADJust:LEVel	157

[SENSe:]ADJust:ALL

This command initiates a measurement to determine and set the ideal settings for the current task automatically (only once for the current measurement).

This includes:

- Center frequency
- Reference level

Example: ADJ:ALL

Manual operation: See "[Adjusting all Determinable Settings Automatically \(Auto All\)](#)" on page 52

[SENSe:]ADJust:FREQuency

This command sets the center frequency to the frequency with the highest signal level in the current frequency range.

Example: ADJ:FREQ

Manual operation: See "[Adjusting the Center Frequency Automatically \(Auto Frequency\)](#)" on page 53

[SENSe:]ADJJust:LEVel

Initiates a single (internal) measurement that evaluates and sets the ideal reference level for the current input data and measurement settings. Thus, the settings of the RF attenuation and the reference level are optimized for the signal level. The R&S FPL1000 is not overloaded and the dynamic range is not limited by an S/N ratio that is too small.

Example: ADJ:LEV

Manual operation: See "[Setting the Reference Level Automatically \(Auto Level\)](#)" on page 53

8.16 Using the status register

The status reporting system stores information about the current state of the R&S FPL1000. This includes, for example, information about errors during operation or information about limit checks. The R&S FPL1000 stores this information in the status registers and in the error queue. You can query the status register and error queue via IEC bus.

The R&S FPL1000-K40 features several status registers that are specific to phase noise measurements. Here is a description of those, including the corresponding remote commands.

- [Status registers for phase noise measurements](#).....157

8.16.1 Status registers for phase noise measurements

The figure below shows the status registers of the phase noise application.

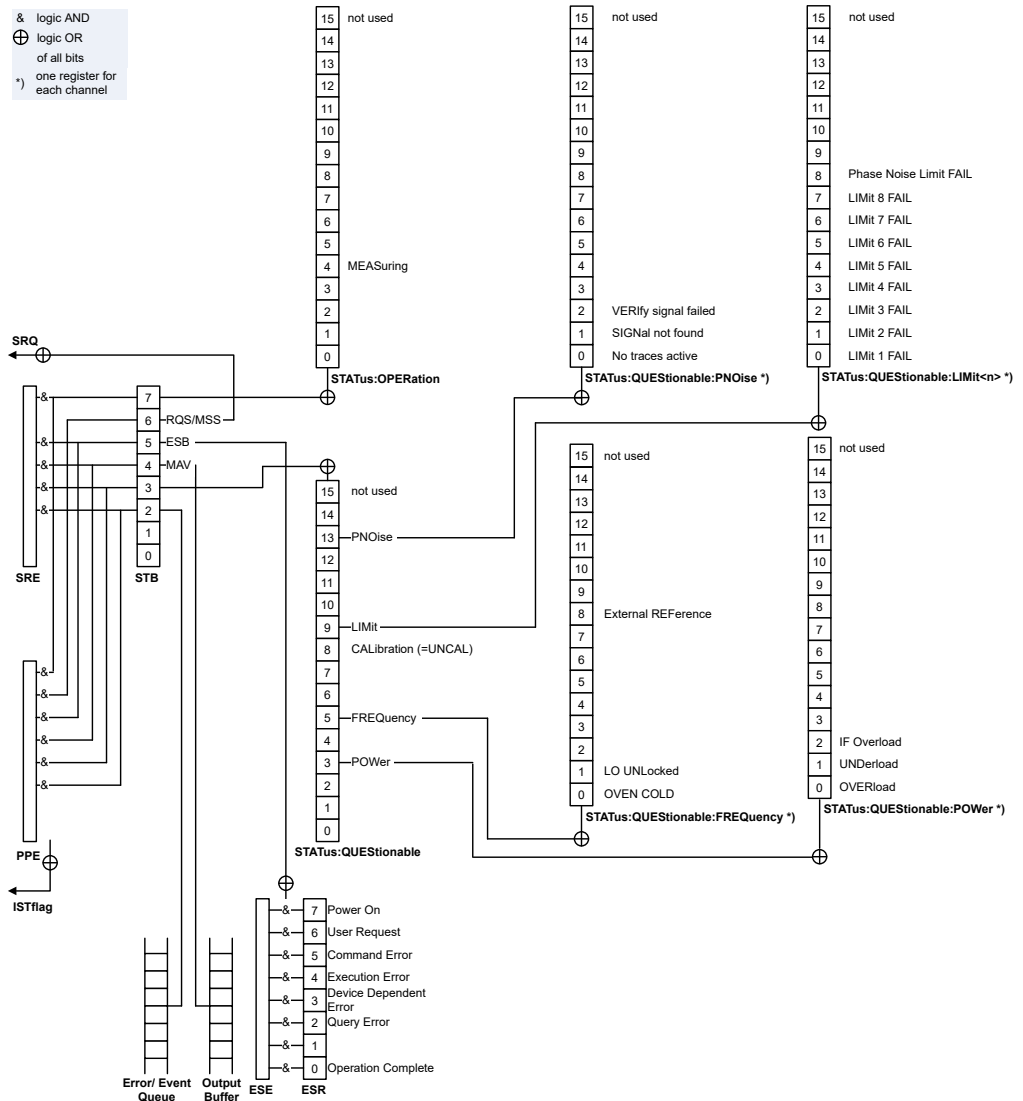

Figure 8-2: Status registers for phase noise measurements

The R&S FPL1000 structures the information hierarchically, with the Status Byte register (STB) and the Service Request Enable mask register (SRE) being on the highest level. The STB gets its information from the standard Event Status Register (ESR) and the Event Status Enable mask register (ESE). The STB and ESR are both defined by IEEE 488.2. In addition to the ESR, the STB also gets information from the Status:OPERation and Status:QUESTIONable registers. These are the link to the lower levels of the status register and are defined by SCPI. They contain information about the state of the instrument.

For a more comprehensive description of the status registers not mentioned here and status register functionality in general see the manual of the base unit.

- [STATus:QUEStionable register](#)..... 159
- [STATus:QUEStionable:POWer register](#)..... 159
- [STATus:QUEStionable:LIMit register](#)..... 160
- [STATus:QUEStionable:PNOise register](#)..... 160
- [Status register remote commands](#)..... 161

8.16.1.1 STATus:QUEStionable register

The `STATus:QUEStionable` register contains information about indefinite states which may occur if the unit is operated without meeting the specifications.

Bit no	Meaning
0 to 2	Unavailable for phase noise measurements.
3	POWer This bit is set if a questionable power occurs.
5 to 7	Unavailable for phase noise measurements.
8	CALibration This bit is set if the R&S FPL1000 is not calibrated.
9	LIMit This bit is set if a limit line is violated.
10-12	Unavailable for phase noise measurements.
13	PNOise This bit is set if the phase noise measurement is questionable.
14	Unavailable for phase noise measurements.
15	This bit is always 0.

8.16.1.2 STATus:QUEStionable:POWer register

The `STATus:QUEStionable:POWer` register contains information about possible overload situations that may occur during operation of the R&S FPL1000.

Bit no	Meaning
0	OVERload This bit is set if an overload occurs at the RF input.
1	UNDerload This bit is set if an underload occurs at the RF input.
2	IF OVERload This bit is set if an overload occurs in the IF path.
3 to 14	Unavailable for phase noise measurements.
15	This bit is always 0.

8.16.1.3 STATUS:QUESTIONABLE:LIMIT register

The STATUS:QUESTIONABLE:LIMIT register contains information about limit lines and the results of a limit checks.

The number of LIMIT registers depends on the number of measurement windows available in any application.

Bit no	Meaning
0	LIMIT 1 FAIL This bit is set if limit line 1 is violated.
1	LIMIT 2 FAIL This bit is set if limit line 2 is violated.
2	LIMIT 3 FAIL This bit is set if limit line 3 is violated.
3	LIMIT 4 FAIL This bit is set if limit line 4 is violated.
4	LIMIT 5 FAIL This bit is set if limit line 5 is violated.
5	LIMIT 6 FAIL This bit is set if limit line 6 is violated.
6	LIMIT 7 FAIL This bit is set if limit line 7 is violated.
7	LIMIT 8 FAIL This bit is set if limit line 8 is violated.
8	Phase Noise LIMIT FAIL This bit is set if a limit of the phase noise limit line is violated.
9 to 14	Unavailable for phase noise measurements.
15	This bit is always 0.

8.16.1.4 STATUS:QUESTIONABLE:PNOISE register

The STATUS:QUESTIONABLE:PNOISE register contains information about the status of phase noise measurements.

Bit no	Meaning
0	No trace are active This bit is set if no trace is on.
1	SIGNAL not found This bit is set if no valid signal could be found.
2	VERIFY This bit is set if signal verification has failed.

Bit no	Meaning
3 to 14	Unavailable for phase noise measurements.
15	This bit is always 0.

8.16.1.5 Status register remote commands

STATus:OPERation[:EVENT]?.....	161
STATus:QUESTionable[:EVENT]?.....	161
STATus:QUESTionable:LIMit[:EVENT]?.....	161
STATus:QUESTionable:PNOise[:EVENT]?.....	161
STATus:QUESTionable:POWer[:EVENT]?.....	161
STATus:OPERation:CONDition?.....	162
STATus:QUESTionable:CONDition?.....	162
STATus:QUESTionable:LIMit:CONDition?.....	162
STATus:QUESTionable:PNOise:CONDition?.....	162
STATus:QUESTionable:POWer:CONDition?.....	162
STATus:OPERation:ENABLE.....	162
STATus:QUESTionable:ENABLE.....	162
STATus:QUESTionable:LIMit:ENABLE.....	162
STATus:QUESTionable:PNOise:ENABLE.....	162
STATus:QUESTionable:POWer:ENABLE.....	162
STATus:OPERation:NTRansition.....	162
STATus:QUESTionable:NTRansition.....	162
STATus:QUESTionable:LIMit:NTRansition.....	162
STATus:QUESTionable:PNOise:NTRansition.....	162
STATus:QUESTionable:POWer:NTRansition.....	162
STATus:OPERation:PTRansition.....	163
STATus:QUESTionable:PTRansition.....	163
STATus:QUESTionable:LIMit:PTRansition.....	163
STATus:QUESTionable:PNOise:PTRansition.....	163
STATus:QUESTionable:POWer:PTRansition.....	163

STATus:OPERation[:EVENT]?

STATus:QUESTionable[:EVENT]?

STATus:QUESTionable:LIMit[:EVENT]? <ChannelName>

STATus:QUESTionable:PNOise[:EVENT]? <ChannelName>

STATus:QUESTionable:POWer[:EVENT]? <ChannelName>

These commands read out the EVENT section of the status register.

The commands at the same time delete the contents of the EVENT section.

Query parameters:

<ChannelName> String containing the name of the channel.
The parameter is optional. If you omit it, the command works for the currently active channel.

Usage: Query only

STATus:OPERation:CONDition?
STATus:QUESTionable:CONDition?
STATus:QUESTionable:LIMit:CONDition? <ChannelName>
STATus:QUESTionable:PNOise:CONDition? <ChannelName>
STATus:QUESTionable:POWer:CONDition? <ChannelName>

These commands read out the CONDition section of the status register.

The commands do not delete the contents of the EVENt section.

Query parameters:

<ChannelName> String containing the name of the channel.
 The parameter is optional. If you omit it, the command works for the currently active channel.

Usage: Query only

STATus:OPERation:ENABle <SumBit>,<ChannelName>
STATus:QUESTionable:ENABle <SumBit>,<ChannelName>
STATus:QUESTionable:LIMit:ENABle <SumBit>,<ChannelName>
STATus:QUESTionable:PNOise:ENABle <SumBit>,<ChannelName>
STATus:QUESTionable:POWer:ENABle <SumBit>,<ChannelName>

These commands control the ENABle part of a register.

The ENABle part allows true conditions in the EVENt part of the status register to be reported in the summary bit. If a bit is 1 in the enable register and its associated event bit transitions to true, a positive transition will occur in the summary bit reported to the next higher level.

Parameters:

<SumBit> Range: 0 to 65535
 <ChannelName> String containing the name of the channel.
 The parameter is optional. If you omit it, the command works for the currently active channel.

STATus:OPERation:NTRansition <SumBit>,<ChannelName>
STATus:QUESTionable:NTRansition <SumBit>,<ChannelName>
STATus:QUESTionable:LIMit:NTRansition <SumBit>,<ChannelName>
STATus:QUESTionable:PNOise:NTRansition <SumBit>,<ChannelName>
STATus:QUESTionable:POWer:NTRansition <SumBit>,<ChannelName>

These commands control the Negative TRansition part of a register.

Setting a bit causes a 1 to 0 transition in the corresponding bit of the associated register. The transition also writes a 1 into the associated bit of the corresponding EVENt register.

Parameters:

<SumBit> Range: 0 to 65535

<ChannelName> String containing the name of the channel.
The parameter is optional. If you omit it, the command works for the currently active channel.

STATus:OPERation:PTRansition <SumBit>,<ChannelName>
STATus:QUESTionable:PTRansition <SumBit>,<ChannelName>
STATus:QUESTionable:LIMit:PTRansition <SumBit>,<ChannelName>
STATus:QUESTionable:PNOise:PTRansition <SumBit>,<ChannelName>
STATus:QUESTionable:POWer:PTRansition <SumBit>,<ChannelName>

These commands control the Positive TRansition part of a register.

Setting a bit causes a 0 to 1 transition in the corresponding bit of the associated register. The transition also writes a 1 into the associated bit of the corresponding EVENT register.

Parameters:

<SumBit> Range: 0 to 65535

<ChannelName> String containing the name of the channel.
The parameter is optional. If you omit it, the command works for the currently active channel.

8.17 Remote control example scripts

This chapter contains a few remote control example scripts for particular phase noise measurement and configuration tasks.

The first chapter contains a short sequence of commands to perform a complete phase noise measurement. The subsequent chapters contain sequences of remote commands to perform special tasks for phase noise measurements like customizing the half decade configuration table.

All examples are based on a measurement range from 100 Hz to 1 MHz.

8.17.1 Performing a basic phase noise measurement

```
//Enter Phase Noise application
INST:SEL PNO
//Perform a preset of the channel
SYST:PRES:CHAN
//Customizing the screen layout.
//Add residual noise window:
LAY:ADD? '1',BEL,RNO
//Add spot noise window:
LAY:ADD? '2',RIGH,SNO
//Configure single sweep measurement.
INIT:CONT OFF
//Define the measurement range.
```

```

FREQ:STAR 100HZ
FREQ:STOP 1MHZ
//Select the sweep type.
SWE:MODE AVER
//Turn on frequency tracking.
FREQ:TRAC ON
//Turn on level tracking.
POW:TRAC ON
//Start the measurement with synchronization.
INIT;*WAI
//Set a marker on trace 1 and query its position.
CALC:MARK ON
CALC:MARK:X 1MHZ
CALC:MARK:Y?
//Query the residual noise results of trace 2 over the measurement range.
CALC:EVAL ON
//Residual FM:
FETC:PNO2:RFM?
//Residual PM:
FETC:PNO2:RPM?
//Residual RMS jitter:
FETC:PNO2:RMS?
//Freeze trace 1 and trace 2.
DISP:TRAC:MODE VIEW
DISP:TRAC2:MODE VIEW
//Activate trace 3 and trace 4.
DISP:TRAC3:MODE WRIT
DISP:TRAC4:MODE WRIT
//Activate linear trace smoothing for trace 4.
DISP:TRAC4:SMO ON
DISP:TRAC4:SMO:TYPE LIN
DISP:TRAC:SMO:APER 1
//Select IQ sweep mode.
SWE:MODE MAN
LIST:BWID:RES:TYPE IQFF
//Repeat the measurement.
INIT;*WAI

```

8.17.2 Configuring the measurement range

Performing a customized IQ FFT measurement over the whole measurement range

```

//Define the measurement range.
FREQ:STAR 100HZ
FREQ:STOP 1MHZ
//Define the measurement settings for all half decades in the measurement range.
SWE:MODE MAN

```

```
//Measurement bandwidth (in per cent of the decade frequency):
LIST:BWID:RAT 20
//Averages:
LIST:SWE:COUN 20
//Mode:
LIST:BWID:RES:TYPE IQFF
//Window function:
LIST:IQW:TYPE GAUS
```

Customizing a half decade configuration table

```
//Define the measurement range.
FREQ:STAR 100HZ
FREQ:STOP 1MHZ
//Define the contents of the table manually.
SWE:MODE MAN
//Customize the range from 100 Hz to 300 Hz.
//Measurement bandwidth:
LIST:RANG5:BWID 1HZ
//Sweep type:
LIST:RANG5:FILT:TYPE IQFF
//Window function:
LIST:RANG5:IQW:TYPE CHEB
//Averages:
LIST:RANG5:SWE:COUN 5
//Customize the range from 300 Hz to 1 kHz.
//Averages:
LIST:RANG6:SWE:COUN 5
```

8.17.3 Scaling the display

Scaling the x-axis: displaying a half decade

```
//Select display of one half decade.
DISP:TRAC:X:SCOP HDEC
//Select the start frequency of the half decade.
DISP:TRAC:X:HDEC 1KHZ
//Display the full measurement range again.
DISP:TRAC:X:SCOP MRAN
```

Scaling the x-axis: customizing the x-axis range

```
//Select manual x-axis scaling.
DISP:TRAC:X:SCOP MAN
//Define the start frequency of the display range.
DISP:TRAC:X:STAR 30KHZ
//Define the stop frequency of the display range.
DISP:TRAC:X:STOP 300KHZ
```

Scaling the y-axis: scaling based on bottom value and range

```
//Select manual y-axis scaling.
DISP:TRAC:Y:MAN BRAN
//Define the bottom value.
DISP:TRAC:Y:RLEV:LOW -160
//Define the range.
DISP:TRAC:Y 60
```

Scaling the y-axis: scaling based on top value and range

```
//Select manual y-axis scaling.
DISP:TRAC:Y:MAN TRAN
//Define the top value.
DISP:TRAC:Y:RLEV -100
//Define the range.
DISP:TRAC:Y 60
```

Scaling the y-axis: scaling based on bottom and top value

```
//Select manual y-axis scaling.
DISP:TRAC:Y:MAN TBOT
//Define the bottom value.
DISP:TRAC:Y:RLEV:LOW -160
//Define the top value.
DISP:TRAC:Y:RLEV -100
```

8.17.4 Configuring numerical results**Defining a user range for residual noise results and query the results**

```
//Select the trace for integration.
CALC:EVAL:USER2:TRAC TRACE1
//Define the start and stop frequencies of the integration range.
CALC:EVAL:USER2:STAR 100KHZ
CALC:EVAL:USER2:STOP 1MHZ
//Query the results.
//Residual FM:
FETC:PNO:USER2:RFM?
//Residual PM:
FETC:PNO:USER2:RPM?
//Residual RMS jitter:
FETC:PNO:USER2:RMS?
```

Working with spot noise results

```
//Turn on spot noise markers on every decade edge.
CALC:SNO:DEC ON
//Turn on spot noise markers at two additional offset frequencies.
CALC:SNO1:STAT ON
```

```

CALC:SNO1:X 50KHZ
CALC:SNO2:STAT ON
CALC:SNO2:X 500KHZ
//Read out spot noise marker results.
//Read out the decade edges:
CALC:SNO:DEC:X?
//Read out the marker positions on the decade edges:
CALC:SNO:DEC:Y?
//Read out customized spot noise marker results:
//At 50 kHz:
CALC:SNO1:Y?
//At 500 kHz:
CALC:SNO2:Y?

```

8.17.5 Using limit lines

Programming a phase noise limit line with three segments

```

//Define the level of the DUT's noise floor.
CALC:PNL:NOIS -134
//Select the number of line segments.
CALC:PNL:TYPE FC3
//Define the characteristics of the line segments.
CALC:PNL:FC1 300KHZ
CALC:PNL:SLOP1 10
CALC:PNL:FC2 30KHZ
CALC:PNL:SLOP2 20
CALC:PNL:FC3 3KHZ
CALC:PNL:SLOP3 30
//Assign the limit line to trace 1 and 2.
CALC:PNL:TRAC 1,2
//Query limit check results.
CALC:PNL:FAIL?

```

Programming a standard limit line

```

//Select or create the limit line by name.
CALC:LIM:NAME 'Phase Noise'
//Comment on the limit line.
CALC:LIM:COMM 'Limit line to test phase noise measurement'
//Define the horizontal data points of the limit line.
CALC:LIM:CONT 100HZ,1kHZ
//Define the vertical data points of an (upper) limit line.
//The unit is fix for phase noise measurements.
CALC:LIM:UPP -160,-170
//Shift the limit line 5 dBc/Hz down.
CALC:LIM:UPP:SHIF -5
//Turn the limit line on.
CALC:LIM:UPP:STAT ON

```

```
//Select the trace to check.  
CALC:LIM:TRAC 3  
//Turn on the limit check.  
CALC:LIM:STAT ON  
//Query the limit check results.  
CALC:LIM:FAIL?
```

8.17.6 Using markers

Using spot noise markers

See ["Working with spot noise results"](#) on page 166.

Using normal and delta markers

```
//Activate and position a normal marker (marker 1).  
CALC:MARK ON  
CALC:MARK:X 1MHZ  
//Position marker 1 on trace 2.  
CALC:MARK:TRAC 2  
//Query the position of marker 1.  
CALC:MARK:Y?  
//Activate and position a delta marker (delta marker 1).  
CALC:DELT ON  
CALC:DELT:X -900KHZ  
//Position the delta marker on trace 2.  
CALC:DELT:TRAC 2  
//Query the position of the delta marker.  
CALC:DELT:Y?  
//Turning all markers off  
CALC:MARK:AOFF  
CALC:DELT:AOFF
```

List of Commands (Phase Noise)

[SENSe:]ADJust:ALL.....	156
[SENSe:]ADJust:FREQuency.....	156
[SENSe:]ADJust:LEVel.....	157
[SENSe:]FREQuency:CENTer.....	98
[SENSe:]FREQuency:STARt.....	105
[SENSe:]FREQuency:STOP.....	105
[SENSe:]FREQuency:TRACk.....	100
[SENSe:]FREQuency:VERify:TOLerance:ABSolute.....	100
[SENSe:]FREQuency:VERify:TOLerance[:RELative].....	100
[SENSe:]FREQuency:VERify[:STATe].....	100
[SENSe:]IQ:DECimation.....	101
[SENSe:]IQ:DPLL.....	101
[SENSe:]IQ:ONLine.....	101
[SENSe:]IQ:TBW.....	102
[SENSe:]LIST:BWIDth[:RESolution]:RATio.....	104
[SENSe:]LIST:BWIDth[:RESolution]:TYPE.....	105
[SENSe:]LIST:RANGe<range>:BWIDth[:RESolution].....	106
[SENSe:]LIST:RANGe<range>:FILTer:TYPE.....	106
[SENSe:]LIST:RANGe<range>:IQWindow:TYPE.....	107
[SENSe:]LIST:RANGe<range>:SWEep:COUNT.....	107
[SENSe:]LIST:SWEep:COUNT.....	107
[SENSe:]LIST:SWEep:COUNT:MULTIplier.....	108
[SENSe:]LIST:SWEep:COUNT:MULTIplier:STATe.....	108
[SENSe:]POWer:RLEVel.....	98
[SENSe:]POWer:RLEVel:VERify:TOLerance.....	102
[SENSe:]POWer:RLEVel:VERify[:STATe].....	102
[SENSe:]POWer:TRACk.....	103
[SENSe:]REJect:AM.....	103
[SENSe:]SPURs:SUPPress.....	131
[SENSe:]SPURs:THReshold.....	132
[SENSe:]SWEep:COUNT.....	109
[SENSe:]SWEep:FHDecade.....	89
[SENSe:]SWEep:FORWard.....	108
[SENSe:]SWEep:MODE.....	109
[SENSe:]SWEep:SVFailed.....	103
ABORT.....	86
CALCulate:PNLimit:FC1 <Frequency>.....	110
CALCulate:PNLimit:FC2 <Frequency>.....	110
CALCulate:PNLimit:FC3 <Frequency>.....	110
CALCulate:PNLimit:FC4 <Frequency>.....	110
CALCulate<n>:DELTaMarker<m>:AOFF.....	149
CALCulate<n>:DELTaMarker<m>:MREFerence.....	149
CALCulate<n>:DELTaMarker<m>:TRACe.....	150
CALCulate<n>:DELTaMarker<m>:X.....	150
CALCulate<n>:DELTaMarker<m>:Y.....	151
CALCulate<n>:DELTaMarker<m>[:STATe].....	149
CALCulate<n>:EVALuation:STARt.....	133

CALCulate<n>:EVALuation:STOP.....	134
CALCulate<n>:EVALuation:USER<range>:START.....	134
CALCulate<n>:EVALuation:USER<range>:STOP.....	134
CALCulate<n>:EVALuation:USER<range>:TRACe.....	135
CALCulate<n>:EVALuation[:STATe].....	133
CALCulate<n>:LIMit:ACTive?.....	113
CALCulate<n>:LIMit:CLEar[:IMMediate].....	113
CALCulate<n>:LIMit:COMMeNt.....	117
CALCulate<n>:LIMit:CONTRol:SHIFt.....	118
CALCulate<n>:LIMit:CONTRol[:DATA].....	117
CALCulate<n>:LIMit:COpy.....	113
CALCulate<n>:LIMit:DELeTe.....	114
CALCulate<n>:LIMit:FAIL?.....	114
CALCulate<n>:LIMit:LOWer:MODE.....	119
CALCulate<n>:LIMit:LOWer:SHIFt.....	119
CALCulate<n>:LIMit:LOWer:STATe.....	115
CALCulate<n>:LIMit:LOWer[:DATA].....	118
CALCulate<n>:LIMit:NAME.....	115
CALCulate<n>:LIMit:STATe.....	115
CALCulate<n>:LIMit:TRACe<t>.....	116
CALCulate<n>:LIMit:TRACe<t>:CHECK.....	116
CALCulate<n>:LIMit:UPPer:MODE.....	119
CALCulate<n>:LIMit:UPPer:SHIFt.....	120
CALCulate<n>:LIMit:UPPer:STATe.....	117
CALCulate<n>:LIMit:UPPer[:DATA].....	120
CALCulate<n>:MARKer<m>:AOFF.....	147
CALCulate<n>:MARKer<m>:FUNCTion:ZOOM.....	152
CALCulate<n>:MARKer<m>:TRACe.....	147
CALCulate<n>:MARKer<m>:X.....	148
CALCulate<n>:MARKer<m>:Y.....	148
CALCulate<n>:MARKer<m>[:STATe].....	147
CALCulate<n>:MATH<t>:STATe.....	122
CALCulate<n>:MATH<t>[:EXPRession][:DEFine].....	121
CALCulate<n>:PNLimit:COpy<k>.....	110
CALCulate<n>:PNLimit:FAIL?.....	112
CALCulate<n>:PNLimit:FC<1 to 5>.....	110
CALCulate<n>:PNLimit:NOISe.....	111
CALCulate<n>:PNLimit:SLOPe<segment>.....	112
CALCulate<n>:PNLimit:TRACe.....	111
CALCulate<n>:PNLimit:TYPE.....	111
CALCulate<n>:SNOise<m>:AOFF.....	138
CALCulate<n>:SNOise<m>:DECades:X.....	139
CALCulate<n>:SNOise<m>:DECades:Y.....	139
CALCulate<n>:SNOise<m>:DECades[:STATe].....	139
CALCulate<n>:SNOise<m>:X.....	140
CALCulate<n>:SNOise<m>:Y.....	141
CALCulate<n>:SNOise<m>[:STATe].....	140
CONFigure:REFMeas.....	87
DISPlay[:WINDow<n>]:MINFo[:STATe].....	151
DISPlay[:WINDow<n>]:MTABLE.....	152

DISPlay[:WINDow<n>]:SIZE.....	91
DISPlay[:WINDow<n>]:TRACe<t>:SElect.....	141
DISPlay[:WINDow<n>]:TRACe<t>:SMOothing:TYPE.....	123
DISPlay[:WINDow<n>]:TRACe<t>:SPURs:SUPPress.....	124
DISPlay[:WINDow<n>]:TRACe<t>:X[:SCALe]:HDECade.....	125
DISPlay[:WINDow<n>]:TRACe<t>:X[:SCALe]:SCOPE.....	125
DISPlay[:WINDow<n>]:TRACe<t>:X[:SCALe]:START.....	126
DISPlay[:WINDow<n>]:TRACe<t>:X[:SCALe]:STOP.....	126
DISPlay[:WINDow<n>]:TRACe<t>:Y[:SCALe].....	126
DISPlay[:WINDow<n>]:TRACe<t>:Y[:SCALe]:AUTO.....	127
DISPlay[:WINDow<n>]:TRACe<t>:Y[:SCALe]:MANual.....	127
DISPlay[:WINDow<n>]:TRACe<t>:Y[:SCALe]:RLEVel.....	128
DISPlay[:WINDow<n>]:TRACe<t>:Y[:SCALe]:RLEVel:LOWer.....	128
DISPlay[:WINDow<n>]:TRACe<t>:Y[:SCALe]:RLEVel:OFFSet.....	129
DISPlay[:WINDow<n>]:ZOOM[:STATe].....	152
DISPlay[:WINDow<n>][:SUBWindow<w>]:TRACe<t>:MODE.....	122
DISPlay[:WINDow<n>][:SUBWindow<w>]:TRACe<t>:SMOothing:APERture.....	122
DISPlay[:WINDow<n>][:SUBWindow<w>]:TRACe<t>:SMOothing[:STATe].....	123
DISPlay[:WINDow<n>][:SUBWindow<w>]:TRACe<t>[:STATe].....	124
FETCh:PNOise<t>:IPN?.....	136
FETCh:PNOise<t>:MEASured:FREQuency?.....	143
FETCh:PNOise<t>:MEASured:LEVel?.....	143
FETCh:PNOise<t>:RFM?.....	136
FETCh:PNOise<t>:RMS?.....	136
FETCh:PNOise<t>:RPM?.....	136
FETCh:PNOise<t>:SPURs:DISCReTe?.....	142
FETCh:PNOise<t>:SPURs:RANDom?.....	142
FETCh:PNOise<t>:SPURs?.....	142
FETCh:PNOise<t>:SWEep:AVG?.....	143
FETCh:PNOise<t>:SWEep:FDRift?.....	144
FETCh:PNOise<t>:SWEep:LDRift?.....	144
FETCh:PNOise<t>:SWEep:MDRift?.....	145
FETCh:PNOise<t>:SWEep:SRATe?.....	145
FETCh:PNOise<t>:SWEep:START?.....	145
FETCh:PNOise<t>:SWEep:STOP?.....	146
FETCh:PNOise<t>:USER<range>:IPN?.....	137
FETCh:PNOise<t>:USER<range>:RFM?.....	137
FETCh:PNOise<t>:USER<range>:RMS?.....	137
FETCh:PNOise<t>:USER<range>:RPM?.....	138
FORMat:DEXPort:DSEParator.....	129
FORMat:DEXPort:HEADer.....	129
FORMat:DEXPort:TRACes.....	130
FORMat:DEXPort:XDIStrib.....	130
FORMat:DIMPort:TRACes.....	130
INITiate:SEQuencer:ABORT.....	88
INITiate:SEQuencer:IMMediate.....	89
INITiate:SEQuencer:MODE.....	89
INITiate<n>:CONMeas.....	87
INITiate<n>:CONTinuous.....	87
INITiate<n>[:IMMediate].....	88

INPut<ip>:ATTenuation.....	98
INPut<ip>:ATTenuation:AUTO.....	99
INPut<ip>:CONNector.....	154
INPut<ip>:COUPling.....	153
INPut<ip>:DPATH.....	153
INPut<ip>:FILTer:YIG[:STATe].....	154
INSTrument:CREate:DUPLicate.....	83
INSTrument:CREate:REPLace.....	83
INSTrument:CREate[:NEW].....	83
INSTrument:DELeTe.....	84
INSTrument:LIST?.....	84
INSTrument:REName.....	85
INSTrument[:SELeCt].....	85
LAYout:ADD[:WINDow]?.....	91
LAYout:CATalog[:WINDow]?.....	92
LAYout:IDENtify[:WINDow]?.....	93
LAYout:MOVE[:WINDow].....	93
LAYout:REMove[:WINDow].....	94
LAYout:REPLace[:WINDow].....	94
LAYout:SPLitter.....	94
LAYout:WINDow<n>:ADD?.....	96
LAYout:WINDow<n>:IDENtify?.....	96
LAYout:WINDow<n>:REMove.....	97
LAYout:WINDow<n>:REPLace.....	97
MMEMory:LOAD<n>:TRACe.....	131
MMEMory:STORe<n>:TRACe.....	131
OUTPut<up>[:STATe].....	155
SOURce<si>:INTerNal:FREQUency.....	155
SOURce<si>:POWer[:LEVel][:IMMediate]:OFFSet.....	156
SOURce<si>:POWer[:LEVel][:IMMediate][:AMPLitude].....	155
STATus:OPERation:CONDition?.....	162
STATus:OPERation:ENABle.....	162
STATus:OPERation:NTRansition.....	162
STATus:OPERation:PTRansition.....	163
STATus:OPERation[:EVENT]?.....	161
STATus:QUEStionable:CONDition?.....	162
STATus:QUEStionable:ENABle.....	162
STATus:QUEStionable:LIMit:CONDition?.....	162
STATus:QUEStionable:LIMit:ENABle.....	162
STATus:QUEStionable:LIMit:NTRansition.....	162
STATus:QUEStionable:LIMit:PTRansition.....	163
STATus:QUEStionable:LIMit[:EVENT]?.....	161
STATus:QUEStionable:NTRansition.....	162
STATus:QUEStionable:PNOise:CONDition?.....	162
STATus:QUEStionable:PNOise:ENABle.....	162
STATus:QUEStionable:PNOise:NTRansition.....	162
STATus:QUEStionable:PNOise:PTRansition.....	163
STATus:QUEStionable:PNOise[:EVENT]?.....	161
STATus:QUEStionable:POWer:CONDition?.....	162
STATus:QUEStionable:POWer:ENABle.....	162

STATus:QUESTionable:POWer:NTRansition.....	162
STATus:QUESTionable:POWer:PTRansition.....	163
STATus:QUESTionable:POWer[:EVENT]?	161
STATus:QUESTionable:PTRansition.....	163
STATus:QUESTionable[:EVENT]?	161
SYSTem:PRESet:CHANnel[:EXEC].....	86
SYSTem:SEQuencer.....	90
TRACe<n>:COPY.....	132
TRACe<n>[:DATA].....	132

Index

A

Abort measurement (remote control)	86
Aborting	
Sweep	49, 50
Application cards	9
Application notes	9
Attenuation	
Mechanical	41
Mechanical (remote control)	98
Auto all	52
Auto frequency	53
Auto level	
Reference level	53
Softkey	53
Automatic	
Frequency detection (remote control)	156
Level detection (remote control)	156
Parameter detection (remote control)	156
Automatic scaling	56
Automatic scaling (remote control)	120
Average count	50
Averaging	47, 48
Averaging (remote control)	103

B

Brochures	9
-----------------	---

C

Center frequency	
Automatic configuration	53
Channel setup	
Creating (remote)	83
Deleting (remote)	84
Duplicating (remote)	83
Querying (remote)	84
Renaming (remote)	85
Replacing (remote)	83
Closing	
Channel setups (remote)	84
Windows (remote)	97
Continue single sweep	
Softkey	50
Continuous sweep	
Softkey	49
Conventions	
SCPI commands	78
Copy trace (remote control)	120
Copying	
Channel setup (remote)	83
Traces	58
Coupling	42, 51
Coupling (remote control)	98

D

Data format	
Remote	129, 130
Data sheets	9
Decimal separator	
Trace export	60

Delta markers	73
Defining	73
Delta markers (remote control)	147
Duplicating	
Channel setup (remote)	83

E

Evaluation methods	
Remote	91
Exporting	
Measurement settings	59
Traces	58, 60

F

FFT window	48
FFT window (remote control)	103
Filters	
YIG (remote)	154
Format	
Data (remote)	129, 130
Frequency	
Nominal	41
Nominal (remote control)	98
Frequency tolerance	42
Frequency tolerance (remote control)	99
Frequency tracking	43
Frequency tracking (remote control)	99
Frequency verification	42
Frequency verification (remote control)	99

G

Getting started	8
Group delay	
Smoothing	57

H

Half decades configuration table	48
Hardware settings	
Displayed	14

I

Initiate measurement (remote control)	86
Installation	11
Instrument security procedures	9

J

Jitter (remote control)	133
-------------------------------	-----

K

Keys	
RUN CONT	49
RUN SINGLE	50

L

Level	
nominal	41
Nominal (remote control)	98
Level tolerance	43
Level tolerance (remote control)	99
Level tracking	44
Level tracking (remote control)	99
Level verification	43
Level verification (remote control)	99
Limit lines	
Noise floor (remote control)	110
Phase noise (remote control)	110
Standard (remote control)	113
Limit lines (remote control)	110

M

Marker to Trace	73
Marker zoom (remote control)	152
Markers	37
Assigned trace	73
Deactivating	74
Delta markers	73
Table	74
Type	73
Markers (remote control)	148
Maximizing	
Windows (remote)	91
Measurement range	46
Measurement range (remote control)	103
Measurement time	48
Mechanical attenuation	41
Mechanical attenuation (remote control)	98
Multiple	
Measurement channels	11

N

Nominal frequency	41
Nominal frequency (remote control)	98
Nominal level	41
Nominal level (remote control)	98

O

Offset frequency	
Start	46
Start (remote control)	103
Stop	46
Stop (remote control)	103
Overview	
Configuration	38

P

Presetting	
Channels	40

Q

Quick Config	
Traces	58

R

Range Start/Stop	46
------------------	----

Range Start/Stop (remote control)	103
RBW	47, 48
RBW (remote control)	103
Reference level	
Auto level	53
Reference marker	73
Release notes	9
Remote commands	
Basics on syntax	78
Boolean values	81
Capitalization	79
Character data	82
Data blocks	82
Numeric values	81
Optional keywords	80
Parameters	80
Strings	82
Suffixes	79
Residual FM (remote control)	133
Residual noise	
Integration range	62
Integration Range	63
Integration Range (remote control)	133
Residual noise (remote control)	133
Residual PM (remote control)	133
Resolution bandwidth	47, 48
Resolution bandwidth (remote control)	103
Restoring	
Channel settings	40
Results	
Data format (remote)	129, 130
Exporting	59
RUN CONT	
Key	49
RUN SINGLE	
Key	50

S

Safety instructions	9
Scaling	
X-axis	55
X-axis (remote control)	120
Y-axis	55
Y-axis (remote control)	120
Scope	
X-axis	55
X-axis (remote control)	120
Security procedures	9
Sequencer	11
Activating (remote)	89
Remote	87
Sequences	
Aborting (remote)	88
Mode (remote)	89
Service manual	8
Single sweep	
Softkey	50
Smoothing	
Traces	28
Traces (group delay)	57
Smoothing type (remote control)	120
Softkeys	
Auto All	52
Auto Freq	53
Auto Level	53
Continue Single Sweep	50

- Continuous Sweep 49
 - Marker to Trace 73
 - Norm/Delta 73
 - Single Sweep 50
 - Trace Config 61
 - Spot noise
 - 10_x Hz 63
 - 10_x Hz (remote control) 133
 - user defined 64
 - user defined (remote control) 133
 - Spur removal 57
 - Spur removal (remote control) 120
 - Spur threshold 57
 - Spur threshold (remote control) 120
 - Stop On Verify Failed 43
 - Suffixes
 - Common 77
 - Remote commands 79
 - Sweep
 - Aborting 49, 50
 - Sweep Count 50
 - Sweep count (remote control) 86
 - Sweep direction 46
 - Sweep direction (remote control) 103
 - Sweep mode 48
 - Sweep mode (remote control) 103
 - Sweep type 47
 - Sweep type (remote control) 103
- T**
- Tolerance
 - frequency 42
 - frequency (remote control) 99
 - level 43
 - level (remote control) 99
 - Trace configuration (remote control) 120
 - Trace copy (remote control) 120
 - Trace export (remote control) 120
 - Trace math
 - Functions 61
 - Settings 61
 - Trace math (remote control) 120
 - Trace offset 56
 - Trace offset (remote control) 120
 - Trace smoothing 28
 - Trace smoothing (remote control) 120
 - Traces
 - Configuration (Softkey) 61
 - Copying 58
 - Copying (remote control) 132
 - Export format 60
 - Exporting 58, 59, 60
 - Mode 57
 - Mode (remote) 122
 - Settings, predefined 58
 - Tracking
 - frequency 43
 - frequency (remote control) 99
 - level 44
 - level (remote control) 99
- V**
- Verify frequency 42
 - Verify frequency (remote control) 99
 - Verify level 43
 - Verify level (remote control) 99
- W**
- White papers 9
 - Window function 48
 - Window function (remote control) 103
 - Window title bar information 15
 - Windows
 - Adding (remote) 91
 - Closing (remote) 97
 - Layout (remote) 94
 - Maximizing (remote) 91
 - Querying (remote) 92, 93
 - Replacing (remote) 94
 - Splitting (remote) 91
 - Types (remote) 91
- X**
- X-axis
 - Half decade 55
 - Half decade (remote control) 120
 - scope 55
 - scope (remote control) 120
 - Start 55
 - Start (remote control) 120
 - Stop 55
 - Stop (remote control) 120
- Y**
- Y-axis
 - Scaling 55
 - Scaling (remote control) 120
 - Scaling automatic (remote control) 120
 - Y-axis scaling
 - Automatic 56
 - YIG-preselector
 - Activating/Deactivating (remote) 154