

R&S® ENV432

Four Line V-Network

User Manual



1326649204
Version 05

ROHDE & SCHWARZ
Make ideas real



This document describes the following R&S®ENV432 models:

- R&S®ENV432 (1326.6105.02)

© 2023 Rohde & Schwarz GmbH & Co. KG
Muehldorfstr. 15, 81671 Muenchen, Germany
Phone: +49 89 41 29 - 0
Email: info@rohde-schwarz.com
Internet: www.rohde-schwarz.com

Subject to change – data without tolerance limits is not binding.

R&S® is a registered trademark of Rohde & Schwarz GmbH & Co. KG.

All other trademarks are the properties of their respective owners.

1326.6492.04 | Version 05 | R&S®ENV432

Throughout this manual, products from Rohde & Schwarz are indicated without the ® symbol, e.g. R&S®ENV432 is indicated as R&S ENV432.

1 Safety and regulatory information

The product documentation helps you use the product safely and efficiently. Follow the instructions provided here and in the following chapters.

Intended use

The R&S ENV432 four-line V-Network is used to measure the unsymmetric disturbance voltage on AC mains and DC lines.

Its principal tasks are:

- To supply the equipment under test with mains voltage
- To provide a standardized load impedance
- Defined transmission of the noise voltage generated by the equipment under test to the EMI test receiver
- Isolation of the test circuit from interference of the power source.

The R&S ENV432 four-line V-Network is constructed using air-core inductances and conforms with the requirements of CISPR 16-1-2 (EN 55016-1-2).

Target audience

Only connect, set up and use LISNs if you are an electrically skilled person. Electrically skilled persons have the relevant education and experience to enable them to perceive risks and to avoid hazards that electricity can cause. Follow the safety instructions provided in [Chapter 1.1, "Safety instructions"](#), on page 3 and the additional information provided during setup or operation procedures.

Where do I find safety information?

Safety information is part of the product documentation. It warns you of potential dangers and gives instructions on how to prevent personal injury or damage caused by dangerous situations. Safety information is provided as follows:

- In [Chapter 1.1, "Safety instructions"](#), on page 3. The same information is provided in many languages as printed "Safety Instructions". The printed "Safety Instructions" are delivered with the product.
- Throughout the documentation, safety instructions are provided when you need to take care during setup or operation.

1.1 Safety instructions

Products from the Rohde & Schwarz group of companies are manufactured according to the highest technical standards. To use the products safely, follow the instructions provided here and in the product documentation. Keep the product documentation nearby and offer it to other users.

Use the line impedance stabilization network (LISN) only for its intended use and within its performance limits. Intended use and limits are described in the product documenta-

tion such as the data sheet, manuals and the printed safety instructions. If you are unsure about the appropriate use, contact Rohde & Schwarz customer service.

LISNs are designed according to CISPR 16-1-2 (EN 55016-1-2) and do not meet the permissible limit for the leakage current as defined in EN 61010-1. In addition, LISNs do not provide basic insulation, rated as measurement category II (protection class 1). Therefore, only connect, set up and use LISNs if you are an electrically skilled person. Electrically skilled persons have the relevant education and experience to enable them to perceive risks and to avoid hazards that electricity can cause.

These users also need sound knowledge of at least one of the languages in which the user interfaces and the product documentation are available.

LISNs can pose hazardous and even life-threatening risks:

- Electrical shock because of a high leakage current and live parts if the LISN is not grounded.
- Electrical shock because the LISN does not have a fuse in the measuring circuit.
- Burns and fire hazard caused by overheating of the housing. Overheating can occur if the ventilation is insufficient or if the cables' cross-section is too small.

If any part of the LISN is damaged or broken, stop using the LISN. Never open the casing of the LISN. Only service personnel authorized by Rohde & Schwarz are allowed to repair the LISN. Contact Rohde & Schwarz customer service at <http://www.rohde-schwarz.com/support>.

Lifting and carrying the product

Look up the weight in the data sheet. If the product is heavy, you cannot move or carry it on your own. A single person can only carry a maximum of 18 kg safely, depending on age, gender and physical condition. To move the product safely, you can also use lifting or transporting equipment such as lift trucks or forklifts. Follow the instructions provided by the lifting or transporting equipment manufacturer.

Choosing the operating site

Only use the LISN indoors in rooms equipped with a protective earth connection (for example EMC test rooms). The product casing is not waterproof and water that enters the casing can electrically connect the casing with live parts. This can lead to electric shock, serious personal injury or death if you touch the casing.

You can operate the product up to an altitude of 2000 m above sea level. The product is suitable for pollution degree 2 environments where nonconductive contamination can occur.

For more information on environmental conditions such as ambient temperature and humidity, see the data sheet.

Setting up the product

Always place the LISN on a stable, flat and level surface with the bottom of the LISN facing down. Make sure that the air supply is not obstructed from any side.

Place the LISN on a nonflammable base, for example, a metal plate, to prevent a fire if the ventilation system fails or if it gets too hot.

If the LISN has foldable feet, always fold the feet completely in or out to ensure stability. The feet can collapse if they are not folded out completely or if the LISN is moved without lifting it. The foldable feet are designed to carry the weight of the LISN, but not an extra load.

Observe the applicable national regulations and standards as part of the installation process.

Protective ground connection

Always establish a protective ground connection before connecting the LISN to a power source. A protective ground protects you from electrically live parts on the casing caused by high leakage currents. High leakage currents can cause electric shock, serious personal injury or death if you touch the casing.

Take the following measures for your safety:

- Only use ground cables that have a sufficient cross-section that complies with VDE 0100-540 part 5-54 (IEC 60364-5-54).
- Screw one end of the ground cable to the protective grounding bolt on the product. Fix the other end of the ground cable securely to the grounding conductor of the measurement area.
- Validate that the ground connection is safe.
- The ground connection must remain until you have disconnected the LISN from the power source.

Connecting to power

The product is an overvoltage category II product and has to be connected to a fixed installation used to supply energy-consuming equipment such as household appliances and similar loads. Electrically powered products have risks, such as electric shock, fire, personal injury or even death.

Observe the protective measures given by VDE 0100-410 (IEC60364-4-41) while working with the LISN.

Take the following measures for your safety:

- Use double-insulated connecting cables with an appropriate minimum cross-section and an appropriate minimum voltage rating. Select the cable based on the maximum power consumption of the device under test, the fuse rating of the building installation and the cable length. When installing the supplied cable sockets, observe the assembly instructions and the requirements of the manufacturer.
- By design, LISNs do not have a fuse in the measuring circuit. Therefore, you have to make sure that the operating circuit between the power supply and the power connector of the LISN is fused correctly.
- Only use the power cable delivered with the product. It complies with country-specific safety requirements.
- Only use intact cables and route them carefully so that they cannot be damaged. Check the power cables regularly to ensure that they are undamaged. Also ensure that nobody can trip over loose cables.

- Only connect the product to a power source with a maximum fuse protection according to the datasheet.
- Ensure that you can disconnect the product from the power source at any time. Pull the power plug to disconnect the product. The power plug must be easily accessible. If the product is integrated into a system that does not meet these requirements, provide an easily accessible circuit breaker at the system level.
- If the LISN has an auxiliary voltage: Before taking the LISN auxiliary voltage into operation, ensure that the voltage and frequency indicated on the product match the available power source. If the values do not match, contact Rohde & Schwarz customer service.
If the ventilation system is powered by an auxiliary voltage, always connect the auxiliary voltage before taking the LISN into operation. Operation without the ventilation system leads to overheating and can cause a fire.
- If the LISN can be powered by an external power supply, make sure that the power supply complies with the requirements for reinforced/double insulation in accordance with DIN/EN/IEC/UL/CSA 61010-1, DIN/EN/IEC/UL/CSA 60950-1 or DIN/EN/IEC/UL/CSA 62368-1.

Using accessories

Select accessories that are suitable for the product and the measurement task, especially if they are from 3rd party manufacturers.



Measurement accessories, such as current clamps or artificial hands must comply with the measurement category of your test setup.



Cleaning the product

Use a dry, lint-free cloth to clean the product. When cleaning, keep in mind that the casing is not waterproof. Do not use liquid cleaning agents.

Meaning of safety labels

Safety labels on the product warn against potential hazards.

	<p>Potential hazard</p> <p>Read the product documentation to avoid personal injury or product damage.</p>
	<p>Heavy product</p> <p>Be careful when lifting, moving or carrying the product. Carrying the product requires a sufficient number of persons or transport equipment.</p>
	<p>Electrical hazard</p> <p>Indicates live parts. Risk of electric shock, fire, personal injury or even death.</p>



	Hot surface Do not touch. Risk of skin burns. Risk of fire.
	Protective conductor terminal Connect this terminal to a grounded external conductor or to protective ground. This connection protects you against electric shock if an electric problem occurs.

1.2 Labels on the product

Labels on the casing inform about:

- Personal safety, see ["Meaning of safety labels"](#) on page 6
- Product and environment safety, see [Table 1-1](#)

Table 1-1: Labels regarding product and environment safety

	Labeling in line with EN 50419 for disposal of electrical and electronic equipment after the product has come to the end of its service life.
	Grounding terminal (earth ground contact)
	Chassis grounding terminal

1.3 Warning messages in the documentation

A warning message points out a risk or danger that you need to be aware of. The signal word indicates the severity of the safety hazard and how likely it will occur if you do not follow the safety precautions.

DANGER

Imminently hazardous situation. Will result in death or serious injury if not avoided.

WARNING

Potentially hazardous situation. Could result in death or serious injury if not avoided.

CAUTION

Potentially hazardous situation. Could result in minor or moderate injury if not avoided.

NOTICE

Potential risks of damage. Could result in damage to the supported product or to other property.

1.4 Korea certification class B



이 기기는 가정용(B급) 전자파 적합기기로서 주로 가정에서 사용하는 것을 목적으로 하며, 모든 지역에서 사용할 수 있습니다.

2 Instrument tour

2.1 Front panel view

The following figure displays the front view of the R&S ENV432. The individual elements are described in detail in the following sections.

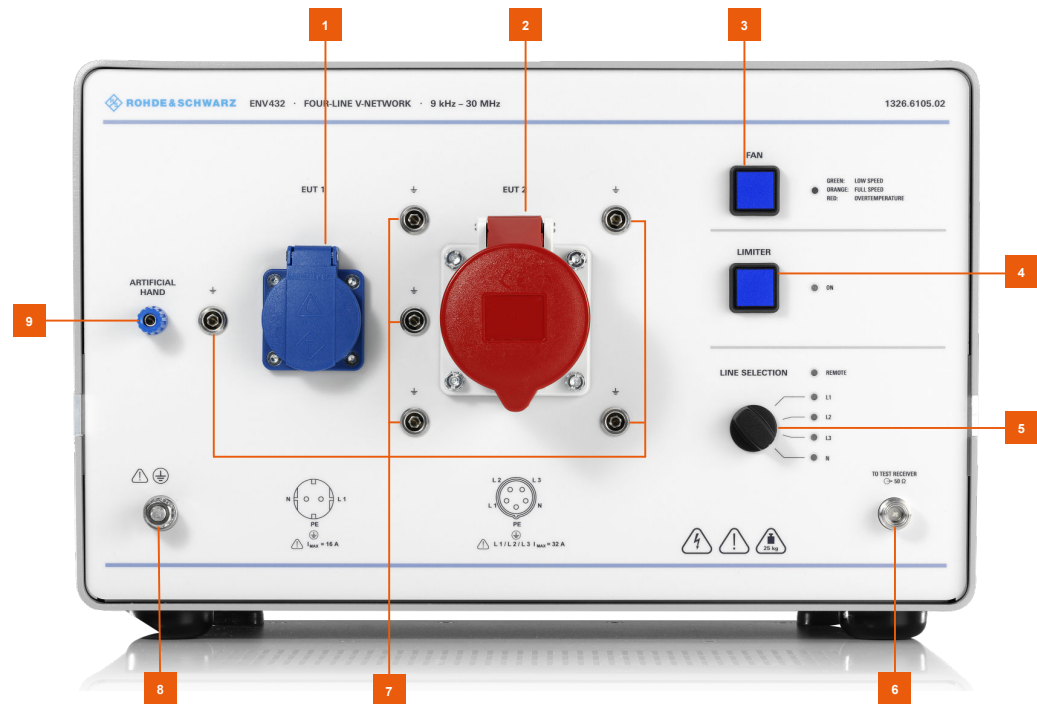

Figure 2-1: Front view

- 1 = Schuko socket (EUT 1)
- 2 = CEE socket (EUT 2)
- 3 = Fan
- 4 = Pulse limiter
- 5 = Line selection
- 6 = Test receiver
- 7 = Ground sockets
- 8 = Protective conductor terminal
- 9 = Artificial hand

2.1.1 Schuko socket (EUT 1)

Connector for disturbance voltage measurements on single-phase EUTs with an alternating voltage up to 240 V and direct voltages up to 350 V. When using this connector, the maximum constant current is 16 A.

2.1.2 CEE socket (EUT 2)

Connector for disturbance voltage measurements on three-phase EUTs with a star type alternating voltage up to 240 V (corresponds to a delta-type alternating voltage of 415 V) and direct voltages up to 350 V. The maximum constant current per phase is 32 A.

2.1.3 Fan

The fan can be manually operated to prevent damage caused by overheating. This is done by pressing the momentary contact switch. The ventilation of the V-network is automatically set to full speed at an internal housing temperature of approx. 50 °C and the fan LED turns orange. If the coil temperature is greater than 100 °C, an acoustic alarm sounds and the fan LED turns red.

See (3) in [Figure 2-1](#).

2.1.4 Pulse limiter

The switchable pulse limiter limits voltage peaks up to 140 dB μ V at the RF output. This corresponds to a measured disturbance signal level of 150 dB μ V. Keep in mind that the test receiver only covers a 9 kHz spectral component of a broadband disturbance signal.

When the device is powered on, the pulse limiter is always activated and must be intentionally switched off. This ensures that it cannot be accidentally switched off.

If the pulse limiter is switched on, the green LED lights up.

See (4) in [Figure 2-1](#).

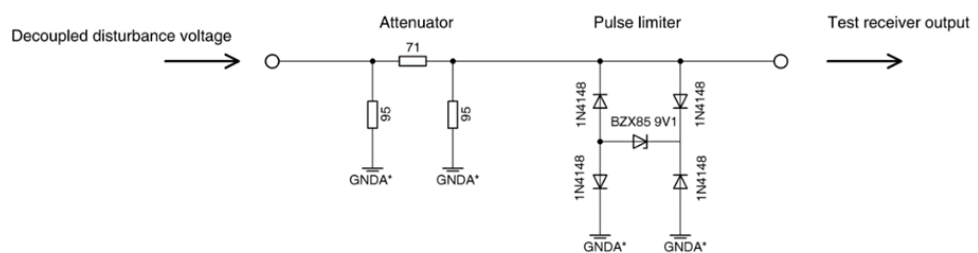

Figure 2-2: Basic principle of the pulse limiter

2.1.5 Line selection

Rotary switch for selecting the measuring path (L1, L2, L3 and N) of the V-network to the test receiver. The measuring path LED which corresponds to the measuring path selection is illuminated in green.

See (5) in [Figure 2-1](#).

2.1.6 Test receiver

N socket (50 Ω) for connecting to the test receiver.

See [Chapter 4.4, "Connecting the test receiver"](#), on page 19 and (6) in [Figure 2-1](#).

2.1.7 Ground sockets

4 mm banana sockets to connect to the reference mass during calibration.

See (7) in [Figure 2-1](#).

2.1.8 Protective conductor terminal

M8 threaded bolt for connecting the protective earth conductor of the equipment under test.

See [Chapter 4.1, "Connecting to protective ground"](#), on page 17 and (8) in [Figure 2-1](#).

2.1.9 Artificial hand

4 mm banana socket to connect an artificial hand to imitate the influence of the hand of the user during measurement of the interference voltage.

See (9) in [Figure 2-1](#).

2.2 Rear panel view

This illustration displays the rear view of the R&S ENV432. The individual elements are described in detail in the following sections.



Figure 2-3: Rear view

- 1 = Remote control
- 2 = CEE connector
- 3 = Protective conductor terminal
- 4 = Ground sockets
- 5 = Auxiliary voltage connection

2.2.1 Remote control

25-pin female D-Sub plug for connecting the remote control cable.

See (1) in [Figure 2-3](#).

For the pin assignment and further information, see [Chapter 5, "Remote control"](#), on page 23.

2.2.2 CEE connector

CEE connector for connecting the supply voltage.

See [Chapter 4.6, "Connecting to power"](#), on page 20 and (2) in [Figure 2-3](#).

2.2.3 Protective conductor terminal

M8 threaded bolt for connecting the R&S ENV432 to a ground conductor in the measurement area.

See [Chapter 4.1, "Connecting to protective ground"](#), on page 17 and (3) in [Figure 2-3](#).

2.2.4 Ground sockets

4 mm banana sockets to connect to the reference mass during calibration.

See (4) in [Figure 2-1](#).

2.2.5 Auxiliary voltage connection

Device plug with line filter for connecting the auxiliary voltage to the power supply for the fan and control logic. The R&S ENV432 can be set for two different nominal AC supply voltages: 115 V and 230 V.

See [Chapter 4.5, "Connecting the auxiliary voltage"](#), on page 19 and (5) in [Figure 2-3](#).

2.3 Block diagram

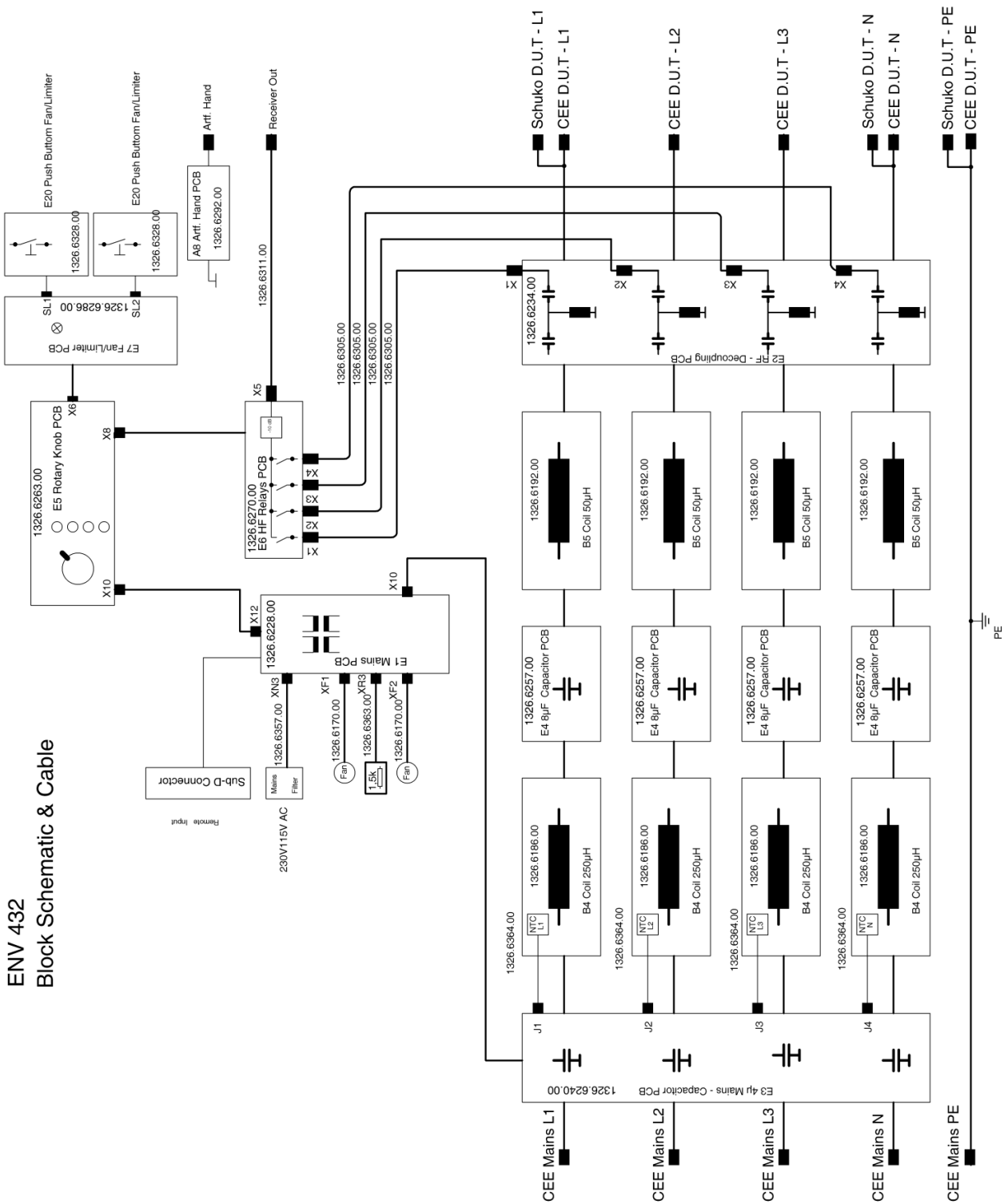

3 Preparing for use

Here, you can find basic information about setting up the product for the first time.

3.1 Lifting and carrying

See "[Lifting and carrying the product](#)" on page 4.

3.2 Unpacking and checking

1. Unpack the product carefully.
2. Retain the original packing material. Use it when transporting or shipping the product later.
3. Using the delivery notes, check the equipment for completeness.
4. Check the equipment for damage.

If the delivery is incomplete or equipment is damaged, contact Rohde & Schwarz.

3.3 Choosing the operating site

Specific operating conditions ensure proper operation and avoid damage to the product and connected devices. For information on environmental conditions such as ambient temperature and humidity, see the data sheet.

See also "[Choosing the operating site](#)" on page 4.

Electromagnetic compatibility classes

The electromagnetic compatibility (EMC) class indicates where you can operate the product. The EMC class of the product is given in the data sheet under "General data".

3.4 Setting up the product

1. Place the product on a stable, flat, level and nonflammable surface.
2. **NOTICE!** Overheating can damage the product.
Prevent overheating as follows:

- Keep a minimum distance of 10 cm between the fan openings of the product and any object in the vicinity.
- Do not place the product next to heat-generating equipment such as radiators or other products.

See also "[Setting up the product](#)" on page 4.

3.5 Considerations for test setup

Observe the operating conditions and performance limits stated in the data sheet.

Cable selection and electromagnetic interference (EMI)

Electromagnetic interference (EMI) can affect the measurement results.

To suppress electromagnetic radiation during operation:

- Use high-quality shielded cables, for example, double-shielded RF and LAN cables.
- Always terminate open cable ends.
- Ensure that connected external devices comply with EMC regulations.

Signal input and output levels

Information on signal levels is provided in the data sheet. Keep the signal levels within the specified ranges to avoid damage to the product and connected devices.

4 Operating the R&S ENV432

Before the R&S ENV432 is put into operation, read the [Safety Instructions](#) carefully.

Putting the R&S ENV432 into operation

Execute the following steps in the order as described. Additional important information is provided in separate chapters that are linked within each step. See also "[Setting up the product](#)" on page 4.

1. Place the R&S ENV432 on a non-flammable surface and remove all surrounding items that could obstruct the ventilation openings as described in [Chapter 3.4, "Setting up the product"](#), on page 15.
2. Establish a protective ground connection of the R&S ENV432. See [Chapter 4.1, "Connecting to protective ground"](#), on page 17 and "[Protective ground connection](#)" on page 5.
3. Establish a reference ground connection of the R&S ENV432. See [Chapter 4.2, "Connecting to reference ground"](#), on page 18.
4. Connect the equipment under test to the R&S ENV432. See [Chapter 4.3, "Connecting the equipment under test"](#), on page 19.
5. Connect the test receiver to the R&S ENV432. See [Chapter 4.4, "Connecting the test receiver"](#), on page 19.
6. **DANGER!** Risk of fire. Do not operate the R&S ENV432 without the auxiliary voltage since this voltage is necessary for operation of the fan system. Failure of the fan system can lead to an overheating of the R&S ENV432, burns if the housing is touched and in extreme cases cause a fire.
To set up the auxiliary voltage supply:
 - a) Check if the voltage of the auxiliary AC supply corresponds to the selected AC supply voltage of the R&S ENV432. See [Chapter 4.5, "Connecting the auxiliary voltage"](#), on page 19 for further details.
 - b) Connect the auxiliary AC voltage to the R&S ENV432.
7. **DANGER!** Risk of electric shock. See "[Protective ground connection](#)" on page 5. Connect the R&S ENV432 to the mains supply. See [Chapter 4.6, "Connecting to power"](#), on page 20 and "[Connecting to power](#)" on page 5.
8. Run the measurement. See [Chapter 4.7, "Example: Measurement setup"](#), on page 21.

4.1 Connecting to protective ground

Connect the R&S ENV432 to a ground conductor before you put it into operation. See "[Protective ground connection](#)" on page 5 for further information.

- ▶ Connect the protective conductor terminal to a grounded external conductor or to protective ground.
Use a ground conductor that is compliant with VDE 0100-540 part 5-54 (IEC 60364-5-54) and has a sufficient cross section of at least 6 mm².



4.2 Connecting to reference ground

The ground connection is not adequate for use as a reference ground in RF noise voltage measurement. To avoid grounding loops, ground the R&S ENV432 only once in the test setup if possible.

1. Attach a wide metal sheet to the grounding rail on the side of the R&S ENV432 using eleven M6 screws.

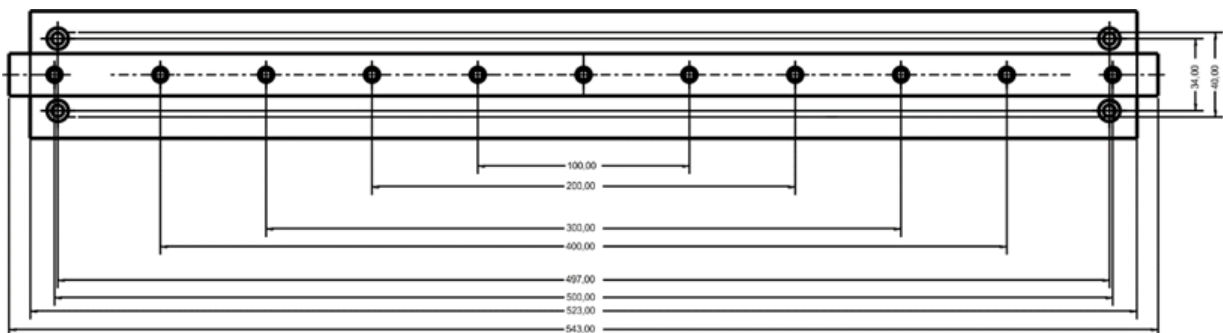

Figure 4-1: Connection to RF reference ground

2. Connect the metal sheet to the reference ground in the test environment.
3. Make sure that disturbance voltages (e.g. from an industrial network) have no impact on the RF reference ground when the protective earth conductor is connected to the protective earth. If so, connect the protective earth using a protective

earth (PE) choke. The choke ensures that no voltages constituting a shock hazard are applied to the housing.

4.3 Connecting the equipment under test

Suitable MC cable sockets for connecting cables are included in the equipment supplied.

1. Connect the equipment under test to the protective earth terminal on the front panel of the R&S ENV432.
2. Connect the equipment under test (EUT) to the single-phase SCHUKO socket outlet (EUT 1) or the three-phase CEE outlet (EUT 2) on the front panel of the R&S ENV432. See (1) and (2) in [Figure 2-1](#).
3. Connect an "artificial hand" to the 4 mm banana jack labeled with "ARTIFICIAL HAND" on the front panel of the R&S ENV432 if you need to mimic the influence of the user's hand while measuring the disturbance voltage.

4.4 Connecting the test receiver

1. Make sure to use a 50 Ω coaxial cable.
2. Connect the test receiver to the "RF TEST RECEIVER" connector on the front panel of the R&S ENV432.

The built-in 10 dB attenuator attenuates the disturbance voltage emitted by the EUT by 10 dB. It ensures the 50 Ω termination required to meet the impedance tolerance, improves matching with the test receiver and provides a sufficiently high-ohmic internal resistance to ensure correct functioning of the pulse limiter.

4.5 Connecting the auxiliary voltage

1. Check whether the selected AC supply voltage on the R&S ENV432 corresponds to the local AC supply voltage. To change the AC supply voltage, see ["To change the AC supply voltage:"](#) on page 20.
The R&S ENV432 can be set for two different nominal AC supply voltages: 115 V and 230 V. In the 115 V setting, the nominal AC supply voltage range is 100 V to 120 V. In the 230 V setting, the nominal AC supply voltage range is 220 V to 240 V.
2. Connect the R&S ENV432 to the AC supply voltage using the supplied power cable. If the R&S ENV432 is correctly connected, one of the four green LEDs for

displaying the test path will light up (depending on the position of the LINE SELECTION rotary switch).

To change the AC supply voltage:

1. Remove the power cable of the AC supply voltage from the R&S ENV432.
2. Remove the fuse holder in the low-temperature connector on the device's rear panel.
See (5) in [Figure 2-3](#).
3. Remove the line voltage selector using a suitable lifting tool such as a screwdriver, size 1.
4. Set the AC supply voltage by correctly inserting (rotating) the line voltage selector.
5. Close the flap on the power connector.

The selected AC supply voltage is visible in the display window.

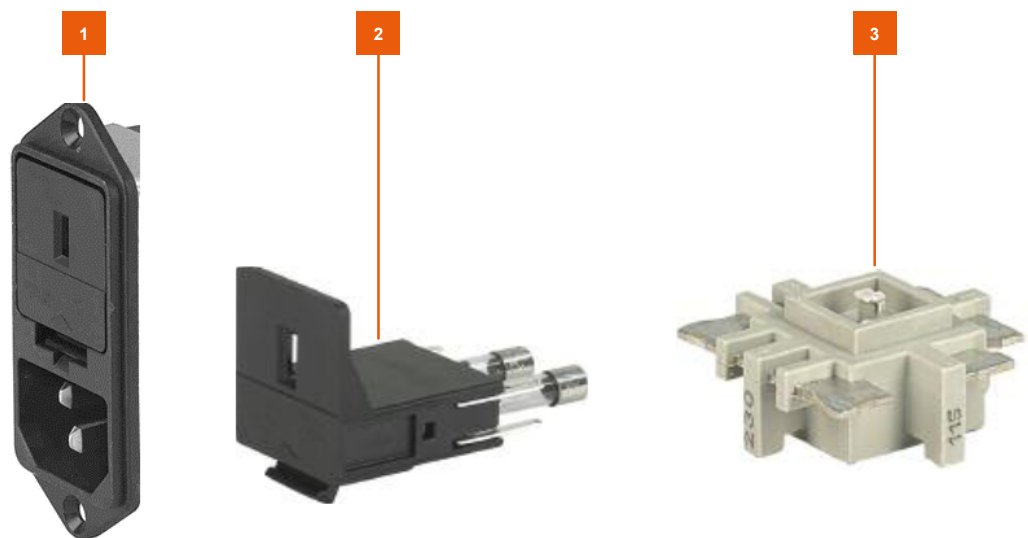

- 1 = Low-temperature socket
2 = Fuse holder
3 = Line voltage selector

4.6 Connecting to power

The device is not equipped with an ON/OFF switch. An interrupting device that the user can easily reach must be provided at the AC supply end to prevent the user from working with AC supply voltage. See also "[Connecting to power](#)" on page 5.

Suitable MC cable sockets for connecting cables are included in the equipment supplied.

1. Make sure that the connected mains supply is sufficiently fused for the maximum permissible continuous current voltage of the R&S ENV432 as listed in the data sheet.
2. **DANGER!** Risk of electric shock. Make sure that the R&S ENV432 is connected to the protective ground terminal before you connect the R&S ENV432 to the power source. The protective ground connection must remain until you have disconnected the R&S ENV432 from the power supply.

See [Chapter 4.1, "Connecting to protective ground"](#), on page 17 and ["Protective ground connection"](#) on page 5.

3. Connect the supply voltage to the CEE built-in (MAINS) connector on the rear panel of the R&S ENV432. See (2) in [Figure 2-3](#).

4.7 Example: Measurement setup

The following example shows a test setup for measuring disturbance voltages on a hand drill. The artificial hand must be connected for this type of EUT. Three metal foils are arranged on the hand drill and connected to the artificial hand.

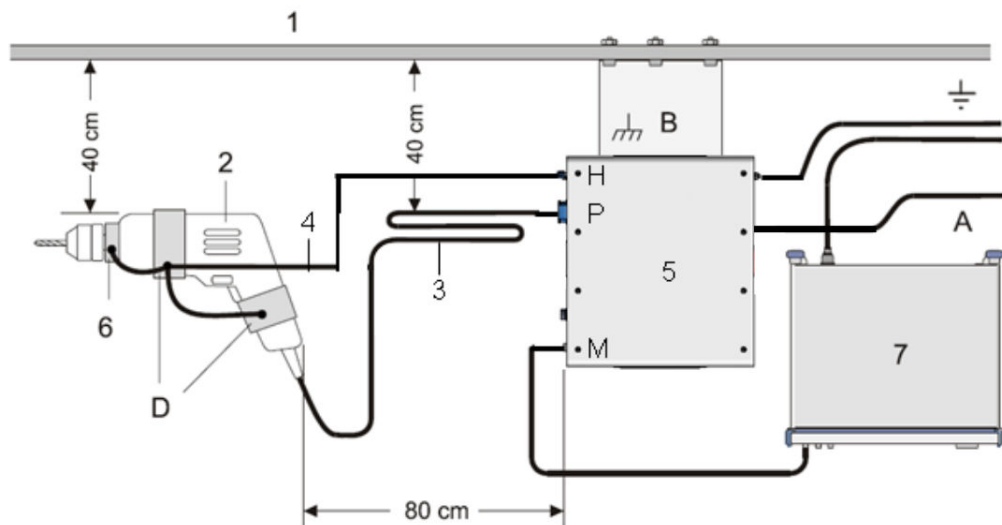

- 1 = Metal wall, at least 2 m x 2 m
- 2 = Equipment under test
- 3 = AC supply cable
- 4 = Connection cable running separately to the hand simulation
- 5 = R&S ENV432
- 6 = Metallic collar capable being gripped
- 7 = Test receiver
- A = Power supply connection
- B = Reference ground connection, low-inductance (e.g. brass plate, 0.2 mm)
- P = Device under test connection (L1, N)

H = Artificial Hand connector
M = Test receiver connector
D = Metal foils

4.8 Disconnecting the R&S ENV432

Execute the following steps in the order as described. Additional important information is provided in separate chapters that are linked within each step.

1. **DANGER!** Risk of electric shock. Always disconnect the R&S ENV432 from the power source before disconnecting it from anything else, especially the protective ground. An unearthed R&S ENV432 is live. Touching a live electrical device causes serious personal injury, or even death.
The protective ground connection must remain until you have disconnected the R&S ENV432 from the power supply. See also "[Protective ground connection](#)" on page 5.
Disconnect the R&S ENV432 from the mains supply. See [Chapter 4.6, "Connecting to power"](#), on page 20.
2. Disconnect the R&S ENV432 from the auxiliary AC supply. See [Chapter 4.5, "Connecting the auxiliary voltage"](#), on page 19.
3. Disconnect the test receiver from the R&S ENV432. See [Chapter 4.4, "Connecting the test receiver"](#), on page 19.
4. Disconnect the equipment under test from the R&S ENV432. See [Chapter 4.3, "Connecting the equipment under test"](#), on page 19.
5. Disconnect the reference ground connection of the R&S ENV432. See [Chapter 4.2, "Connecting to reference ground"](#), on page 18.
6. Disconnect the protective ground connection of the R&S ENV432. See [Chapter 4.1, "Connecting to protective ground"](#), on page 17.

5 Remote control

The test path of the V-network to the test receiver can be selected manually using the rotary switch or via remote control. For remote control, the V-network is connected to the test receiver via a connecting cable.

5.1 Pin assignment

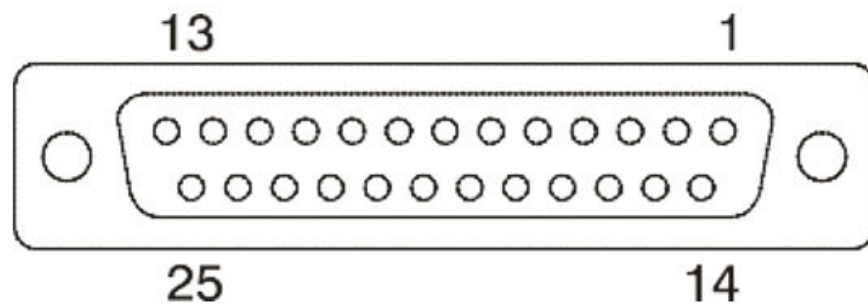

SUB-D 25
female

12 = GND
14 = Test path N
15 = Test path L1
16 = Test path L2
17 = Test path L3

5.2 Test path selection

Pin 14	Pin 15	Pin 16	Pin 17	Selected line
L	H	H	H	N
H	L	H	H	L1
H	H	L	H	L2
H	H	H	L	L3

L level = 0 V to 0.4 V

H level = 2 V to 5 V

To activate remote control, apply one of the pins 14, 15, 16 or 17 to GND (pin 12).

5.3 Test receiver control menus

The independent R&S ENV432 control menu is used for remote control with R&S EMI test receiver types ESW, ESL, ESRP, ESR, ESU, and for EMC32 and ELEKTRA software. The EZ-21 connecting cables (3 m or 10 m) are used for open-loop control with the ESU test receiver. The EZ-29 connecting cables (3 m or 10 m) are used for the ESL, ESRP, ESR and ESW test receivers.

For remote control with R&S EMI test receivers ESHS10, ESHS20/30, ESAI/ESBI/ESMI, ESCS, ESS, ESPI, ESCI, ESIB and in the ES-K1 and ESXS-K1 EMI software, the operating menu for the ESH2-Z5 V-network also applies for control of the R&S ENV432.

For control of the R&S ENV432 with the R&S ESxI EMI test receivers ESAI; ESBI; ESMI, the EZ-22 connecting cable is used. For control with other test receivers, the EZ-21 connecting cables (3 m or 10 m) are used.

The pulse limiter cannot be remote controlled. For reasons of safety, the pulse limiter is switched on during remote control. If impairment of the disturbance spectrum is suspected due to pulse limiting, the pulse limiter can be switched off on the front panel and the measurement repeated manually.

6 Transporting

Lifting and carrying

See:

- ["Lifting and carrying the product"](#) on page 4

Packing

Use the original packaging material. It consists of antistatic wrap for electrostatic protection and packing material designed for the product.

If you do not have the original packaging, use similar materials that provide the same level of protection. You can also contact your local Rohde & Schwarz service center for advice.

Securing

When moving the product in a vehicle or using transporting equipment, make sure that the product is properly secured. Only use items intended for securing objects.

Transport altitude

Unless otherwise specified in the data sheet, the maximum transport altitude without pressure compensation is 4500 m above sea level.

7 Maintenance, storage and disposal

Before any maintenance work on the R&S ENV432 is executed, read the [Safety Instructions](#) carefully.

The device does not need to be regularly maintained. Maintenance is limited essentially to wiping the device's external surfaces. See "[Cleaning the product](#)" on page 6.

7.1 Device safety inspection

A device safety inspection of the network as defined in BGV A3 is not possible because of the design according to CISPR 16-1-2 (EN 55016-1-2) and measurement set-up according to CISPR 16-2-1 (EN 55016-2-1). Therefore, the following examinations must be carried out as a minimum requirement.

7.1.1 Visual inspection

Ensure that parts relevant for active and passive safety are not visibly damaged or even unsuitable for use in the device.

1. Remove the R&S ENV432 from the mains supply.
2. Let the R&S ENV432 cool down to ambient temperature.
3. Check the following parts for damage:
 - a) Housing, displays, carrying handles, air vents
 - b) Device connection cables, connection points and mains lead cleats
 - c) Mains plug, fuse holder
 - d) Labeling and markings, warning notices
 - e) Isolated parts, wiring insulation
 - f) Plug connections and clamping points
 - g) Vent and leakage paths must not be altered unacceptably.

If any damage is detected, remove the R&S ENV432 from the test environment and contact R&S customer support. See [Chapter 7.2, "Contacting customer support"](#), on page 26.

7.2 Contacting customer support

Technical support – where and when you need it

For quick, expert help with any Rohde & Schwarz product, contact our customer support center. A team of highly qualified engineers provides support and works with you

to find a solution to your query on any aspect of the operation, programming or applications of Rohde & Schwarz products.

Contact information

Contact our customer support center at www.rohde-schwarz.com/support, or follow this QR code:



Figure 7-1: QR code to the Rohde & Schwarz support page

7.3 Storage and packaging

Protect the product against dust. Ensure that the environmental conditions, e.g. temperature range and climatic load, meet the values specified in the data sheet.

7.4 Disposal

Rohde & Schwarz is committed to making careful, ecologically sound use of natural resources and minimizing the environmental footprint of our products. Help us by disposing of waste in a way that causes minimum environmental impact.

Disposing electrical and electronic equipment

A product that is labeled as follows cannot be disposed of in normal household waste after it has come to the end of its service life. Even disposal via the municipal collection points for waste electrical and electronic equipment is not permitted.



Figure 7-2: Labeling in line with EU directive WEEE

Rohde & Schwarz has developed a disposal concept for the eco-friendly disposal or recycling of waste material. As a manufacturer, Rohde & Schwarz completely fulfills its obligation to take back and dispose of electrical and electronic waste. Contact your local service representative to dispose of the product.