

# R&S® ZNH

## Handheld Vector Network Analyzer User Manual



1334598502  
Version 06

**ROHDE & SCHWARZ**  
Make ideas real



This document describes the following R&S®ZNH models and options with firmware version 1.40 and higher:

- R&S®ZNH4 (1321.1611.04)
- R&S®ZNH8 (1321.1611.08)
- R&S®ZNH18 (1321.1611.18)
- R&S®ZNH26 (1321.1611.26)
- R&S®ZNH4 (1321.1611.54, equivalent to 1321.1611.04)
- R&S®ZNH8 (1321.1611.58, equivalent to 1321.1611.08)
- R&S®ZNH18 (1321.1611.68, equivalent to 1321.1611.18)
- R&S®ZNH26 (1321.1611.76, equivalent to 1321.1611.26)
- R&S®ZNH-K9 (1334.6800.02)
- R&S®ZNH-K10 (1334.6846.02)
- R&S®ZNH-K29 (1334.6823.02)
- R&S®ZNH-K45 (1334.6852.02)
- R&S®ZNH-K47 (1334.6875.02)
- R&S®ZNH-K66 (1334.6869.02)
- R&S®ZNH-K68 (1334.6881.02)
- R&S®ZNH-K69 (1334.6830.02)

© 2023 Rohde & Schwarz GmbH & Co. KG  
Muehldorfstr. 15, 81671 Muenchen, Germany  
Phone: +49 89 41 29 - 0

Email: [info@rohde-schwarz.com](mailto:info@rohde-schwarz.com)

Internet: [www.rohde-schwarz.com](http://www.rohde-schwarz.com)

Subject to change – data without tolerance limits is not binding.

R&S® is a registered trademark of Rohde & Schwarz GmbH & Co. KG.

Trade names are trademarks of the owners.

1334.5985.02 | Version 06 | R&S®ZNH

The following abbreviations are used throughout this manual: R&S®ZNH is abbreviated as R&S ZNH.

# Contents

<b>1</b>	<b>Preface</b> .....	<b>11</b>
1.1	<b>Safety information</b> .....	<b>11</b>
1.2	<b>Korea certification class B</b> .....	<b>11</b>
1.3	<b>Documentation overview</b> .....	<b>11</b>
1.3.1	Manuals.....	11
1.3.2	Data sheet.....	12
1.3.3	Calibration certificate.....	12
1.3.4	Release notes, open source acknowledgment.....	13
1.3.5	Application notes, application cards, videos.....	13
1.4	<b>Conventions used in the documentation</b> .....	<b>13</b>
1.4.1	Typographical conventions.....	13
1.4.2	Conventions for procedure descriptions.....	13
1.4.3	Notes on screenshots.....	14
<b>2</b>	<b>Welcome to the R&amp;S ZNH</b> .....	<b>15</b>
<b>3</b>	<b>Getting started</b> .....	<b>16</b>
3.1	<b>Preparing for use</b> .....	<b>16</b>
3.1.1	Putting into operation.....	16
3.1.2	Switching the instrument on and off.....	23
3.2	<b>Instrument tour</b> .....	<b>24</b>
3.2.1	Front view.....	24
3.2.2	Top view.....	25
3.2.3	Left view.....	27
3.2.4	Right view.....	28
3.2.5	Rear view.....	29
3.2.6	Display overview.....	29
<b>4</b>	<b>Basic operation</b> .....	<b>31</b>
4.1	<b>Screen layout and elements</b> .....	<b>31</b>
4.1.1	Title bar.....	32
4.1.2	Trace label.....	32
4.1.3	Measurement result view.....	33

4.1.4	Measurement trace window.....	33
4.1.5	Parameter view.....	36
4.1.6	Configuration overview.....	37
<b>4.2</b>	<b>Configuring the R&amp;S ZNH.....</b>	<b>39</b>
4.2.1	Configuring the hardware.....	40
4.2.2	Using the GPS receiver.....	41
4.2.3	Configuring date and time.....	43
4.2.4	Selecting regional settings.....	44
4.2.5	Configuring the display.....	46
4.2.6	Configuring the audio output.....	48
4.2.7	Configuring power supply.....	49
4.2.8	Configuring calibration kit model.....	50
4.2.9	Resetting the R&S ZNH.....	51
<b>4.3</b>	<b>Connecting the R&amp;S ZNH to a PC.....</b>	<b>52</b>
4.3.1	LAN connection.....	53
4.3.2	USB connection.....	58
<b>4.4</b>	<b>Managing options.....</b>	<b>59</b>
4.4.1	Enabling options.....	59
4.4.2	Checking options.....	60
4.4.3	Managing options with R&S license manager.....	61
<b>4.5</b>	<b>Measuring transmissions.....</b>	<b>62</b>
4.5.1	Transmission measurement.....	64
4.5.2	Reflection measurement.....	65
<b>4.6</b>	<b>Using a power sensor.....</b>	<b>66</b>
4.6.1	Measuring the power with a power sensor.....	66
4.6.2	Measuring power and return loss.....	69
<b>4.7</b>	<b>Saving and recalling results and settings.....</b>	<b>70</b>
<b>5</b>	<b>Instrument functions.....</b>	<b>72</b>
<b>5.1</b>	<b>Touchscreen gesture element.....</b>	<b>72</b>
5.1.1	Change center frequency.....	72
5.1.2	Change reference level.....	73
5.1.3	Change span.....	73
5.1.4	Add marker.....	74

5.1.5	Move marker.....	74
5.1.6	Delete all markers.....	75
5.1.7	Hide or unhide measurement result view display.....	75
5.1.8	Preview screenshot.....	76
5.1.9	Skip wizard measurement.....	76
<b>5.2</b>	<b>On-screen keyboard.....</b>	<b>77</b>
<b>5.3</b>	<b>Front panel keys.....</b>	<b>78</b>
5.3.1	POWER key.....	78
5.3.2	Screenshot key.....	78
5.3.3	Softkey.....	78
5.3.4	System keys.....	78
5.3.5	Function keys.....	79
5.3.6	Keypad.....	81
5.3.7	Navigation controls.....	82
<b>5.4</b>	<b>Presetting the R&amp;S ZNH.....</b>	<b>83</b>
<b>5.5</b>	<b>Configuring measurements.....</b>	<b>84</b>
<b>5.6</b>	<b>Working directory.....</b>	<b>84</b>
<b>5.7</b>	<b>Taking screenshots.....</b>	<b>85</b>
<b>5.8</b>	<b>Managing datasets.....</b>	<b>87</b>
5.8.1	Saving datasets.....	89
5.8.2	Restoring datasets.....	91
5.8.3	Deleting datasets.....	93
5.8.4	Export datasets.....	94
<b>5.9</b>	<b>Updating the firmware.....</b>	<b>94</b>
<b>5.10</b>	<b>Installing firmware options.....</b>	<b>94</b>
<b>5.11</b>	<b>Device documentation.....</b>	<b>94</b>
<b>6</b>	<b>Working with the measurement wizard.....</b>	<b>96</b>
<b>6.1</b>	<b>Performing and configuring measurements.....</b>	<b>96</b>
<b>6.2</b>	<b>Evaluating results.....</b>	<b>105</b>
<b>7</b>	<b>Cable and antenna test mode.....</b>	<b>107</b>
<b>7.1</b>	<b>Performing cable and antenna measurements.....</b>	<b>109</b>
7.1.1	Reflection measurements.....	110
7.1.2	1-Port cable loss measurement.....	113

7.1.3	Transmission measurements.....	114
7.1.4	Waveguide measurements.....	116
7.1.5	Distance to fault measurements.....	118
7.1.6	Time domain reflectometry (TDR).....	120
7.1.7	Smith chart.....	121
7.1.8	Phase measurement.....	123
7.1.9	Calibrating measurements.....	124
<b>7.2</b>	<b>Configuring cable and antenna tests.....</b>	<b>129</b>
7.2.1	Selecting the cable mode.....	129
7.2.2	Configuring the horizontal axis.....	132
7.2.3	Configuring the vertical axis.....	136
7.2.4	Configuring the tracking generator.....	138
7.2.5	Setting the measurement bandwidth.....	138
7.2.6	Setting the measurement sweep.....	139
<b>7.3</b>	<b>Analyzing measurement results.....</b>	<b>140</b>
7.3.1	Working with traces.....	140
7.3.2	Using markers.....	142
7.3.3	Using display line.....	148
7.3.4	Using limit lines.....	149
<b>8</b>	<b>Vector network analysis.....</b>	<b>153</b>
<b>8.1</b>	<b>Calibrating measurements.....</b>	<b>154</b>
8.1.1	Calibration states.....	155
8.1.2	Calibration methods.....	156
8.1.3	Performing calibration.....	157
<b>8.2</b>	<b>Offset parameters.....</b>	<b>159</b>
8.2.1	Definition of offset parameters.....	159
8.2.2	Definition of loss parameters.....	160
8.2.3	Auto length.....	160
8.2.4	Auto length and loss.....	161
8.2.5	Application and effect of offset parameters.....	162
8.2.6	Offset parameters for balanced ports.....	163
<b>8.3</b>	<b>Performing vector network analysis measurements.....</b>	<b>163</b>
8.3.1	S-Parameter measurements.....	164

8.3.2	Wave measurements.....	165
8.3.3	Ratios measurements.....	167
8.3.4	Mixed mode measurements.....	168
8.3.5	Time domain analysis.....	170
<b>8.4</b>	<b>Configuring vector network analysis.....</b>	<b>179</b>
8.4.1	Configuring the horizontal axis.....	179
8.4.2	Configuring the vertical axis.....	179
8.4.3	Selecting the measurement format.....	181
8.4.4	Setting the sweep parameters.....	183
<b>8.5</b>	<b>Analyzing measurement results.....</b>	<b>185</b>
8.5.1	Working with traces.....	186
8.5.2	Using markers.....	187
8.5.3	Using display lines.....	188
8.5.4	Using limit lines.....	188
<b>9</b>	<b>Vector voltmeter.....</b>	<b>190</b>
<b>9.1</b>	<b>Calibrating measurements.....</b>	<b>191</b>
<b>9.2</b>	<b>Performing voltmeter measurements.....</b>	<b>191</b>
<b>9.3</b>	<b>Analyzing measurement results.....</b>	<b>192</b>
<b>10</b>	<b>Power meter.....</b>	<b>193</b>
<b>10.1</b>	<b>Using a power sensor.....</b>	<b>193</b>
10.1.1	Connecting a power sensor.....	194
10.1.2	Performing and configuring measurements.....	195
<b>10.2</b>	<b>Using a directional power sensor.....</b>	<b>198</b>
10.2.1	Connecting a directional power sensor.....	199
10.2.2	Performing and configuring measurements.....	200
<b>11</b>	<b>Performing pulse power measurements.....</b>	<b>203</b>
<b>11.1</b>	<b>Configuring the numerical result display.....</b>	<b>206</b>
<b>11.2</b>	<b>Configuring the power vs time result display.....</b>	<b>206</b>
11.2.1	Determining pulse characteristics.....	207
11.2.2	Selecting the video bandwidth.....	208
11.2.3	Averaging traces.....	208
11.2.4	Triggering measurements.....	209

11.2.5	Selecting the result unit.....	210
11.2.6	Scaling the y-axis.....	210
11.2.7	Using markers.....	210
<b>12</b>	<b>Performing Frequency Conversion Power Measurements.....</b>	<b>211</b>
<b>12.1</b>	<b>Gain Calibration.....</b>	<b>213</b>
<b>12.2</b>	<b>Configuring the Numerical Result Display.....</b>	<b>214</b>
<b>12.3</b>	<b>Configuring the Power with Frequency Result Display.....</b>	<b>214</b>
12.3.1	Determining Frequency Conversion Measurement.....	214
12.3.2	Defining Measurement Format.....	216
12.3.3	Defining Source Signal.....	217
12.3.4	Trace Memory.....	217
12.3.5	Setting the Measurement Sweep.....	218
12.3.6	Selecting the Result Unit.....	218
12.3.7	Scaling the Y-Axis.....	218
12.3.8	Using Markers.....	218
<b>13</b>	<b>Remote commands.....</b>	<b>219</b>
<b>13.1</b>	<b>Interfaces and protocols.....</b>	<b>219</b>
13.1.1	LAN interface.....	220
13.1.2	USB interface.....	220
13.1.3	Protocols.....	221
<b>13.2</b>	<b>Setting up the remote control connection.....</b>	<b>222</b>
13.2.1	Preparing for remote control.....	222
<b>13.3</b>	<b>Instrument model and command processing.....</b>	<b>223</b>
13.3.1	Input unit.....	224
13.3.2	Command recognition.....	224
13.3.3	Data base and instrument hardware.....	225
13.3.4	Status reporting system.....	225
13.3.5	Output unit.....	225
<b>13.4</b>	<b>SCPI command structure and syntax.....</b>	<b>226</b>
13.4.1	Structure of a command.....	226
13.4.2	Parameters.....	231
13.4.3	Structure of a program message.....	233
13.4.4	Responses to queries.....	234



<b>13.5</b>	<b>Command sequence and command synchronization.....</b>	<b>235</b>
<b>13.6</b>	<b>Remote control - commands.....</b>	<b>235</b>
13.6.1	Common commands.....	236
13.6.2	Remote commands of the vector network analyzer.....	240
13.6.3	Remote commands of the cable and antenna analyzer.....	263
13.6.4	Remote commands of the power meter.....	303
13.6.5	Remote commands of the frequency conversion power measurement.....	309
13.6.6	Remote commands of the time domain analysis.....	317
13.6.7	Remote commands of the vector voltmeter.....	330
13.6.8	File management.....	335
13.6.9	Making and storing screenshots.....	341
13.6.10	Configuring data capture.....	342
13.6.11	Configuring the instrument.....	344
13.6.12	Status reporting system.....	358
<b>14</b>	<b>Menu and softkey overview.....</b>	<b>375</b>
<b>14.1</b>	<b>General functions.....</b>	<b>375</b>
14.1.1	General R&S ZNH setup.....	375
14.1.2	File management.....	381
14.1.3	Operating mode selection.....	382
<b>14.2</b>	<b>Functions of the power meter.....</b>	<b>383</b>
14.2.1	Power meter measurements.....	383
14.2.2	Frequency parameters.....	387
14.2.3	FORMAT parameters.....	388
14.2.4	SCALE parameters.....	389
14.2.5	Sweep configuration.....	390
14.2.6	Limits line parameters.....	390
14.2.7	Trace parameters.....	391
14.2.8	Marker parameters.....	391
14.2.9	CAL parameters.....	392
<b>14.3</b>	<b>Functions of the wizard.....</b>	<b>393</b>
14.3.1	Measurement wizard.....	393
<b>14.4</b>	<b>Functions of the cable &amp; antenna.....</b>	<b>395</b>
14.4.1	Cable & Antenna measurements.....	395

14.4.2	FREQ/DIST parameters.....	396
14.4.3	SCALE parameters.....	397
14.4.4	SWEEP parameters.....	398
14.4.5	FORMAT parameters.....	398
14.4.6	TRACE parameters.....	398
14.4.7	Limits line parameters.....	399
14.4.8	MARKER parameters.....	400
14.4.9	CAL parameters.....	401
<b>14.5</b>	<b>Functions of the vector network analyzer.....</b>	<b>401</b>
14.5.1	Vector network analyzer measurements.....	401
14.5.2	FREQ/DIST parameters.....	403
14.5.3	SCALE parameters.....	403
14.5.4	SWEEP parameters.....	404
14.5.5	FORMAT parameters.....	404
14.5.6	TRACE parameters.....	405
14.5.7	Limits Line parameters.....	406
14.5.8	MARKER parameters.....	406
14.5.9	CAL parameters.....	407
<b>14.6</b>	<b>Functions of the vector voltmeter.....</b>	<b>408</b>
14.6.1	Vector voltmeter measurements.....	409
14.6.2	FREQ/DIST parameters.....	409
14.6.3	SCALE parameters.....	409
14.6.4	SWEEP parameters.....	409
14.6.5	TRACE parameters.....	410
14.6.6	CAL parameters.....	410
<b>15</b>	<b>Contacting customer support.....</b>	<b>411</b>
	<b>List of commands.....</b>	<b>412</b>
	<b>Index.....</b>	<b>419</b>

# 1 Preface

## 1.1 Safety information

The product documentation helps you use the R&S ZNH safely and efficiently. Follow the instructions provided here and in the printed "Basic Safety Instructions". Keep the product documentation nearby and offer it to other users.

### Intended use

The R&S ZNH is intended for the development, production and verification of electronic components and devices in industrial, administrative, and laboratory environments. Use the R&S ZNH only for its designated purpose. Observe the operating conditions and performance limits stated in the data sheet.

### Where do I find safety information?

Safety information is part of the product documentation. It warns you about the potential dangers and gives instructions how to prevent personal injuries or damage caused by dangerous situations. Safety information is provided as follows:

- The printed "Basic Safety Instructions" provide safety information in many languages and are delivered with the R&S ZNH.
- Throughout the documentation, safety instructions are provided when you need to take care during setup or operation.

## 1.2 Korea certification class B



이 기기는 가정용(B급) 전자파 적합기기로서 주로 가정에서 사용하는 것을 목적으로 하며, 모든 지역에서 사용할 수 있습니다.

## 1.3 Documentation overview

This section provides an overview of the R&S ZNH user documentation.

### 1.3.1 Manuals

You find the documents on the R&S ZNH product page at:

<http://www.rohde-schwarz.com/manual/znh>

### **Getting started manual**

Introduces the R&S ZNH and describes how to set up and start working with the product. The printed document is delivered with the instrument.

### **User manual**

Contains the description of all instrument modes and functions. It also provides an introduction to remote control, a complete description of the remote control commands with programming examples, and information on maintenance and instrument interfaces. Includes the contents of the getting started manual.

The *online version* of the user manual provides the complete contents for immediate display on the internet.

### **Basic safety instructions**

Contains safety instructions, operating conditions and further important information. The printed document is delivered with the instrument.

### **Instrument security procedures manual**

Deals with security issues when working with the R&S ZNH in secure areas.

### **Service manual**

Describes the performance test for checking the rated specifications, module replacement and repair, firmware update, troubleshooting and fault elimination, and contains mechanical drawings and spare part lists. The service manual is available for registered users on the global Rohde & Schwarz information system (GLORIS, <https://gloris.rohde-schwarz.com>).

## **1.3.2 Data sheet**

The data sheet contains the technical specifications of the R&S ZNH. It also lists the options and their order numbers as well as optional accessories.

The brochure provides an overview of the R&S ZNH and shows its specific characteristics.

<http://www.rohde-schwarz.com/brochure-datasheet/znh>

## **1.3.3 Calibration certificate**

The document is available on <https://gloris.rohde-schwarz.com/calcert>. You need the device ID of your instrument, which you can find on a label on the rear panel.

### 1.3.4 Release notes, open source acknowledgment

The release notes list new features, improvements and known issues of the current firmware version, and describe the firmware installation.

The open source acknowledgment document provides verbatim license texts of the used open source software.

<http://www.rohde-schwarz.com/firmware/znh>

### 1.3.5 Application notes, application cards, videos

These documents contain information about possible applications and background information on various topics, see [www.rohde-schwarz.com/apnotes](http://www.rohde-schwarz.com/apnotes)

## 1.4 Conventions used in the documentation

### 1.4.1 Typographical conventions

The following text markers are used throughout this documentation:

Convention	Description
"Graphical user interface elements"	All names of graphical user interface elements on the screen, such as dialog boxes, menus, options, buttons, and softkeys are enclosed by quotation marks.
[Keys]	Key and knob names are enclosed by square brackets.
Filenames, commands, program code	Filenames, commands, coding samples and screen output are distinguished by their font.
<i>Input</i>	Input to be entered by the user is displayed in italics.
<a href="#">Links</a>	Links that you can click are displayed in blue font.
"References"	References to other parts of the documentation are enclosed by quotation marks.

### 1.4.2 Conventions for procedure descriptions

When operating the instrument, several alternative methods may be available to perform the same task. In this case, the procedure using the touchscreen is described. Any elements that can be activated by touching can also be clicked using an additionally connected mouse. The alternative procedure using the keys on the instrument or the on-screen keyboard is only described if it deviates from the standard operating procedures.

The term "select" may refer to any of the described methods, i.e. using a finger on the touchscreen, a mouse pointer in the display, or a key on the instrument or on a keyboard.

### 1.4.3 Notes on screenshots

When describing the functions of the product, we use sample screenshots. These screenshots are meant to illustrate as many as possible of the provided functions and possible interdependencies between parameters. The shown values may not represent realistic usage scenarios.

The screenshots usually show a fully equipped product, that is: with all options installed. Thus, some functions shown in the screenshots may not be available in your particular product configuration.

## 2 Welcome to the R&S ZNH

The R&S ZNH is a new generation Rohde & Schwarz vector network analyzer developed to meet demanding customer requirements. Offering touchscreen input, the analyzer enhances user experience in making measurements fast and easy.

This user manual contains a description of the functionality that the instrument provides. The latest version is available for download at the product homepage (<http://www.rohde-schwarz.com/product/znh.html>).

## 3 Getting started

The following chapters are identical to those in the printed R&S ZNH Getting Started manual.

- [Preparing for use](#).....16
- [Instrument tour](#).....24

### 3.1 Preparing for use

#### 3.1.1 Putting into operation

This chapter describes the basic steps to be taken when setting up the R&S ZNH for the first time.

#### **WARNING**

##### **Risk of injury due to disregarding safety information**

Observe the information on appropriate operating conditions provided in the data sheet to prevent personal injury or damage to the instrument. Read and observe the basic safety instructions provided with the instrument, in addition to the safety instructions in the following sections. In particular:

- Do not open the instrument casing.

#### **NOTICE**

##### **Risk of instrument damage due to inappropriate operating conditions**

Specific operating conditions are required to ensure accurate measurements and to avoid damage to the instrument. Observe the information on appropriate operating conditions provided in the basic safety instructions and the instrument's data sheet.

#### **NOTICE**

##### **Instrument damage caused by electrostatic discharge**

Electrostatic discharge (ESD) can damage the electronic components of the instrument and the device under test (DUT). Electrostatic discharge is most likely to occur when you connect or disconnect a DUT or test fixture to the instrument's test ports. To prevent electrostatic discharge, use a wrist strap and cord and connect yourself to the ground, or use a conductive floor mat and heel strap combination.



**NOTICE****Risk of instrument damage during operation**

An unsuitable operating site or test setup can cause damage to the instrument and to connected devices. Ensure the following operating conditions before you switch on the instrument:

- The instrument is dry and shows no sign of condensation.
- The instrument is positioned as described in the following sections.
- The ambient temperature does not exceed the range specified in the data sheet.
- Signal levels at the input connectors are all within the specified ranges.
- Signal outputs are correctly connected and are not overloaded.

**EMI impact on measurement results**

Electromagnetic interference (EMI) may affect the measurement results.

To suppress generated electromagnetic interference (EMI):

- Use suitable shielded cables of high quality. For example, use double-shielded RF and LAN cables.
- Always terminate open cable ends.
- Note the EMC classification in the data sheet.

**3.1.1.1 Unpacking and checking the instrument**

Check the equipment for completeness using the delivery note and the accessory lists for the various items. Check the instrument for any damage. If there is damage, immediately contact the carrier who delivered the instrument. Make sure not to discard the box and packing material.

**Packing material**

Retain the original packing material. If the instrument needs to be transported or shipped later, you can use the material to protect the control elements and connectors.

**NOTICE****Risk of damage during transportation and shipment**

Insufficient protection against mechanical and electrostatic effects during transportation and shipment can damage the instrument.

- Always make sure that sufficient mechanical and electrostatic protection is provided.
- When shipping an instrument, the original packaging should be used. If you do not have the original packaging, use sufficient padding to prevent the instrument from moving around inside the box. Pack the instrument in antistatic wrap to protect it from electrostatic charging.
- Secure the instrument to prevent any movement and other mechanical effects during transportation.

**3.1.1.2 Accessory list**

The instrument comes with the following accessories:

- Power supply cable and adapter set
- Li-ion rechargeable battery
- USB2.0 cable A-Mini
- Side strap
- "Getting Started" printed manual
- Document folder containing safety instructions, KC and CE certificate

Optional accessories and their order numbers are listed in the data sheet.

**3.1.1.3 Setting up the R&S ZNH**

The R&S ZNH is mainly used for diagnostic purpose during the installation of RF feeder cables and antennas for all kinds of radio transmitters. It can also be used to characterize both amplitude and phase measurements on complex test devices and discrete components with its S-parameters measurements.

Depending on the environment, you can adjust the viewing angle of the display and either lay it out horizontally or prop it up using the support on the back of the R&S ZNH.



When laid out horizontally for operation from above, the R&S ZNH is tilted slightly due to the micro-stand at the back. This position provides the optimum viewing angle for the display.

To allow easy operation from the front and still be able to read the display, you can swing out the support on the back of the R&S ZNH.

Before you turn on the R&S ZNH, you should insert the lithium ion battery included in the delivery into the battery compartment located at the back of the R&S ZNH.

### Insert battery

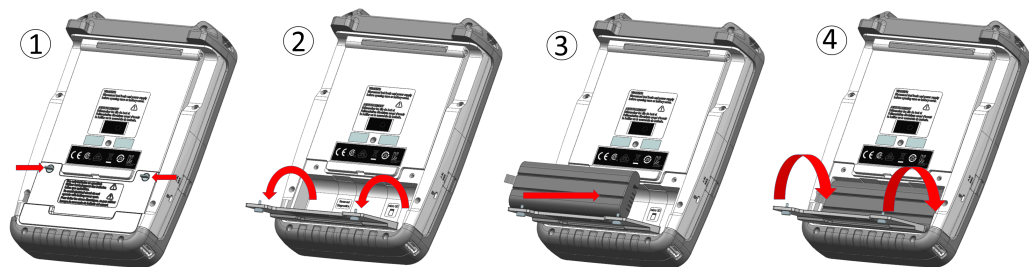

1. Unscrew the two thumb screws located on the battery compartment.
2. Open the cover.
3. Insert the battery into the R&S ZNH.
4. Close the cover and screw back the thumb screws.

You can operate the R&S ZNH with the AC adapter or the battery. Both are included in the delivery.

#### 3.1.1.4 Using the AC adapter

### NOTICE

#### Risk of instrument damage

To avoid instrument damage:

- Only use the power supply (R&S HA-Z301, order number 1321.1386.02) included in the delivery.
- Make sure that the AC supply voltage is compatible to the voltage specified on the power supply unit.
- Attach the appropriate adapter to the power supply.

Connect the AC adapter to the DC port on the left side of the R&S ZNH (item 1 of [Figure 3-1](#)). Make sure to fully insert the AC adapter plug into the DC port.

Depending on the system you need, firmly connect the appropriate power cable included in the delivery to the AC adapter (item 2 of [Figure 3-1](#)).

Finally, connect the power cable plug to an AC power outlet.



**Figure 3-1: AC adapter**

1 = AC adapter  
2 = Power cable

The voltage range of the AC power supply is 100 V to 240 V AC.

After the R&S ZNH is connected to the power supply, you can turn it on with the [Power] key on the front panel.

### 3.1.1.5 Battery operation

The R&S ZNH has a smart battery indicator which displays the battery charging status on the [Power] key as well as the battery icon shown at the top right corner of the display screen. See [Chapter 3.2.6, "Display overview"](#), on page 29.

The lithium ion battery has a capacity of 6.9Ah / 74Wh (at nominal voltage of 10.80V) and it allows operation at preset condition of up to 4 hours when it is fully charged.

The actual operation time depends on the current charged status (see [Figure 3-2](#)), the ambient temperature and the operating mode of the R&S ZNH.

For a summary of the LED indication of the [Power] key, see [Table 3-1](#).

The battery charging and discharging process of the battery icon indicated in the display screen is illustrated below:

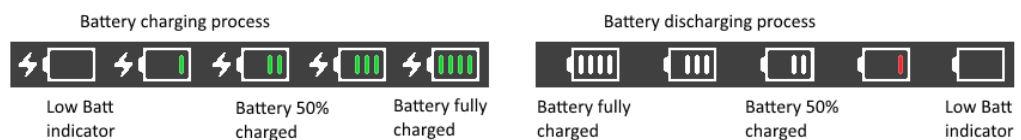

**Figure 3-2: Battery charging and discharging process**

Charging time is about three hours when the R&S ZNH is in inactive mode (i.e. R&S ZNH is switched off). If the instrument is in active mode (i.e. R&S ZNH is switched on), the charging time is extended to about five hours because the charging current is reduced as the power is partially drained by the usage of the R&S ZNH.

During operation in the field, you can also charge the battery with the car adapter (R&S HA-Z302, order number 1321.1340.02). You can connect the car adapter to the DC port. With the car adapter, you are able to charge the R&S ZNH via the car's cigarette lighter socket. A replacement battery (R&S HA-Z306, order number 1321.1334.02) with the same capacity and charging time as the battery included in the standard delivery is also available if necessary.



Battery dispatched during delivery is not fully charged, for battery operation you have to charge it first.

To charge the battery, connect the charger to AC power adapter included in the delivery. For more information, see "[Using an external battery charger](#)" on page 21.

### Using an external battery charger

You can also use an external battery charger (R&S HA-Z303, order number 1321.1328.02) to charge the battery.

To charge the battery externally, put the battery into the external charger and supply it with power via the AC power adapter.

An amber LED on the charger indicates the charging process. The LED turns to green when the battery is fully charged. A red LED on the charger indicates that the battery is not charging or the charging failed.

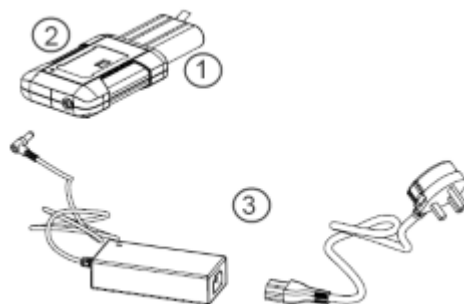

**Figure 3-3: External battery charger**

1 = Lithium ion battery R&S HA-Z306

2 = External charger R&S HA-Z303

3 = Power supply unit R&S HA-Z301 or car adapter R&S HA-Z302

## WARNING

### Risk of traffic accidents, physical injury and property damage

- Turn off the R&S ZNH while driving or while the engine is on.
- Operation of the R&S ZNH via the cigarette lighter socket while driving or while the engine on is prohibited.

### 3.1.1.6 Battery maintenance

The R&S ZNH comes with a lithium-ion battery. In general, these batteries are easy to handle. When you handle the battery, follow the instruction mentioned in the safety instructions and in the following chapters.

#### Handling

- The battery has been designed for a specific application. Do not use it for any other applications.
- Do not connect batteries in series or parallel as it can cause serious damage.
- Observe correct polarities during installation and charging.
- Do not heat over 70°C. The battery contains thermal fuses that could activate and render the battery inoperable.
- The battery contains an electronic device for protection against deep discharge, overcharge and short-circuiting between the terminals.
  - If you cannot discharge the battery, it may be deep discharged. Charge the battery for 0.5 hours and check again.
  - If you cannot charge the battery, it may be overcharged. Discharge the battery and check again.
  - If the battery has been short-circuited, charge it to reset the electronics.
  - If the battery still does not work, contact the Rohde & Schwarz customer support.
- Do not allow metallic objects to come into contact with the terminals.
- Do not solder directly to the battery.

#### Storage

The battery self-discharges while not in use. When storing the battery for an extended period of time, make sure to

- Handle the battery carefully to avoid short circuits. Make sure that leads and terminals are insulated.
- Keep the battery in the supplied packaging before use. The temperature should be between -20°C to 50°C.
- Store the battery at an initial state of charge between 15% and 50% of its capacity. When calculating the initial state of charge, consider
  - The maximum consumption of electronic devices
  - The self-discharge of the battery - the higher the state of charge, the higher the rate of self-discharge
- Avoid a deep discharge of the battery. A deep discharge occurs when the state of charge falls below 5% of the battery's capacity.
- Recharge the battery at least every six months.

Should the battery voltage be low or even 0 V, the battery protection circuit may have gone into a sleep mode. In that case, reset the battery with an approved charger.

### Transportation

No special regulations apply for transporting the battery. The battery cells contain no metallic lithium.

### End of life

The capacity of the battery decreases after it has gone through numerous charge cycles and nearing its end of life. When the battery is dead, do not open the battery. Do not dispose battery in fire.

## 3.1.2 Switching the instrument on and off

The instrument can be powered with an AC or DC (battery operated or via car adapter) input. See [Chapter 3.1.1.4, "Using the AC adapter"](#), on page 19.

- ▶ Press [Power] key to switch on the instrument.  
During booting, the R&S ZNH displays a splash screen to indicate the operable frequency range of the instrument. Depending on the frequency upgrade option installed, the respective splash screen is loaded.  
After booting, the instrument is ready for operation.  
Refer to the instrument brochure for the list of options available.
- ▶ Press [Power] key to switch off the instrument.





### NOTICE

#### Risk of losing data

If a running instrument (without battery) is disconnected directly from the power cord, the instrument loses its current settings. Furthermore, program data may be lost. Press [Power] key first to shut down the application properly.

The following shows the [POWER] key behavior in different operation modes.

**Table 3-1: Summary of LED indication on POWER key**

LED indication on [Power] key	Descriptions
Green LED 	Instrument is in operation mode.
Blue LED 	Instrument is in switch off mode with a fully charged battery. A blinking blue LED indicates that the battery charging is in process.
Amber LED 	Instrument is in switch off mode with AC supply and there is no battery in it.
Red LED 	There is an error in the battery charging.
LED "OFF" 	This is an indication that there is no AC or DC supply to the instrument. The instrument is in a switch off mode.

## 3.2 Instrument tour

This chapter describes the instrument in different views.

### 3.2.1 Front view



**Figure 3-4: Front view of R&S ZNH**

- 1 = RF port 1
- 2 = BNC connector
- 3 = Headphone jack
- 4 = USB ports
- 5 = RF port 2
- 6 = Touch-sensitive screen area
- 7 = Softkey labels (on display)
- 8 = Softkey
- 9 = Systems keys
- 10 = DC port (behind protective cap)
- 11 = Kensington lock
- 12 = Function keys
- 13 = On/off key
- 14 = Alphanumeric key
- 15 = Unit keys
- 16 = Back key
- 17 = Cancel key
- 18 = Rotary knob
- 19 = Screenshot key
- 20 = LAN and mini USB port (behind protective cap)
- 21 = Micro-SD card slot (not visible as it is located behind the battery compartment)

For a description of the keys, see [Chapter 5.3, "Front panel keys"](#), on page 78.



**NOTICE****Instrument damage caused by cleaning agents**

Cleaning agents contain substances that may damage the instrument. For example, cleaning agents that contain a solvent may damage the front panel labeling, plastic parts, or the display.

Never use cleaning agents such as solvents (thinners, acetone, etc.), acids, bases, or other substances.

The outside of the instrument can be cleaned sufficiently using a soft, lintfree dust cloth.

**3.2.2 Top view**

- 1 = RF port 1
- 2 = BNC connector
- 3 = Headphone jack
- 4 = USB type A connector
- 5 = RF port 2

**RF port 1 / RF port 2**

Depending on the instrument models, different RF connectors are used.

- Type N connectors for model 04 / 08 / 18
- RPC 3.5 mm connectors for model 26

The RF ports serve as output for the RF stimulus signal and as input for the measured RF signals from the DUT (response signals). Maximum permissible power at the RF input port is 0 dBm, maximum 50 Vdc. Depending on the models, connect a cable or DUT to the RF input with a respective connector. Use a cable to connect the DUT to the R&S ZNH, if necessary.

- With a single RF port, it is possible to generate a stimulus signal and measure the response signal in reflection. For measurement examples, see [Chapter 7.1, "Performing cable and antenna measurements"](#), on page 109.
- With two RF ports, it is possible to perform a full two-port measurement. For measurement examples, see [Chapter 8, "Vector network analysis"](#), on page 153.

**WARNING****Risk of electrical shock**

To avoid electrical shock, the DC input voltage must never exceed the value specified on the housing.



**NOTICE****Risk of instrument damage**

To avoid damage to the coupling capacitor, input attenuator or the mixer, the DC input voltage must never exceed the value specified in the data sheet.

**NOTICE****Risk of DUT damage**

The R&S ZNH displays a signal source indicator on the [title bar](#). When the indicator shows a full green circle, signal source is present on the RF out connector.

To prevent damage on DUT, it is important to consider maximum input power on DUT before connection.

-  : Signal source is present on the RF out connector
-  : Signal source is not present on the RF out connector

**BNC connector**

You can connect the BNC connector for various applications. It supports an external trigger signal or an external reference signal. It can also be configured as a BIAS port.

When the BNC connector is configured as a trigger input, it controls the start of a measurement. The trigger mode is selected in the SWEEP menu. The trigger threshold is similar to that of TTL signals.

When the BNC connector is configured as reference input, you can apply a 10 MHz external reference signal to it for frequency synchronization. The external reference label **Ext Ref** is displayed at the top right corner of the [title bar](#) to indicate that the reference signal is supplied via external signal input. The label turns green when the reference signal is detected.

The level of the reference signal must be larger than 0 dBm. If there is no reference signal present at the BNC connector, the R&S ZNH displays an appropriate message. Thus, measurements without a valid reference can be avoided.

With R&S ZNH-K10 (order number 1334.6846.02), the BNC connector can be configured as an internal DC bias port providing direct current output. Active equipment under test can be supplied with power via the bias port.

**NOTICE****Risk of instrument damage**

To avoid damage to the tracking generator output, never apply currents greater than 600 mA or voltages greater than 20 V to the BNC connectors if the BNC connectors are not configured as BIAS output ports.

If they are configured as BIAS ports, never apply currents greater than 600 mA or voltages greater than 50 V.

**Headphone jack**

The 3.5 mm connector for headphones has an internal impedance of approximately 10  $\Omega$ .

**USB type A connector**

The USB port provides the USB interface to connect a memory stick and store data sets or screenshots. It can also be used to control the operation of the external power sensor.

**WARNING****Risk of electrical shock**

To avoid electrical shock, the DC input voltage must never exceed the value specified on the housing.

**NOTICE****Risk of instrument damage**

- Make sure not to overload the RF input and keep within the maximum allowed signal levels. Refer to the datasheet for the maximum allowed signal levels.
- To avoid damage to the coupling capacitor, input attenuator or the mixer, the DC input voltage of 50 V must never be exceeded.

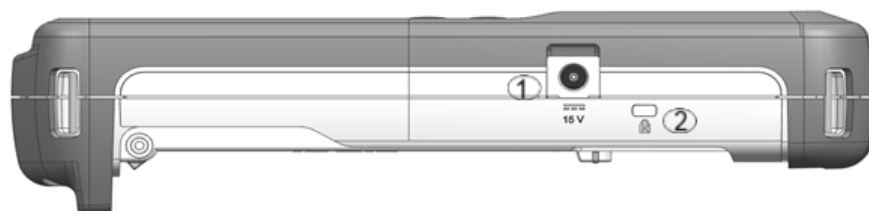
**3.2.3 Left view**

- 1 = DC input
- 2 = Kensington lock slot

### DC input

The R&S ZNH is supplied with power by the AC/DC transformer power supply via the DC connector. You can also use the DC connector to charge the battery.

### Kensington lock slot

A Kensington lock can be anchored to the R&S ZNH housing to secure it to a workstation mechanically.

## 3.2.4 Right view

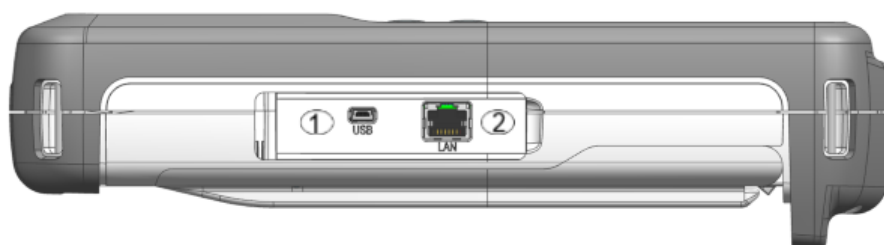

- 1 = Mini USB port
- 2 = LAN port

### LAN connector

RJ-45 connector to connect the instrument to a Local Area Network (LAN) and transfer data in both directions. It supports up to 100 Mbit/s.

### USB type B connector (mini USB)

Mini USB connector to connect a computer for remote control of the instrument and transfer data in both directions.

### 3.2.5 Rear view

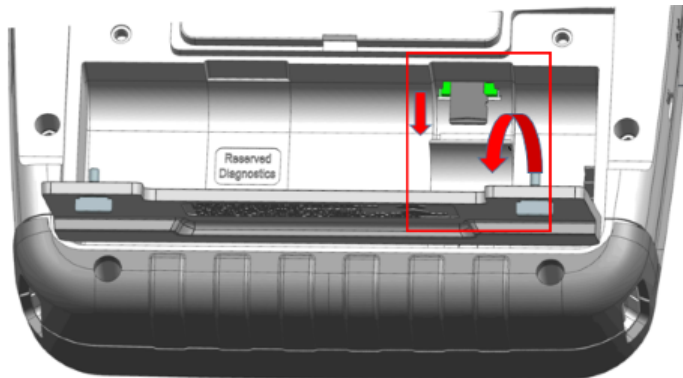

The micro-SD card slot is located behind the battery compartment of the R&S ZNH.

Peel open the micro-SD card protective cap to access to the micro-SD card slot. You can use the micro-SD card to store datasets or screenshots.

### 3.2.6 Display overview

The display area has a touch-sensitive screen, the touch functionality can be turned on or off in the instrument setup menu.

For information on the different sections of the display area and touchscreen gestures, see [Chapter 4.1, "Screen layout and elements"](#), on page 31 and [Chapter 5.1, "Touch-screen gesture element"](#), on page 72 in the R&S ZNH user manual.

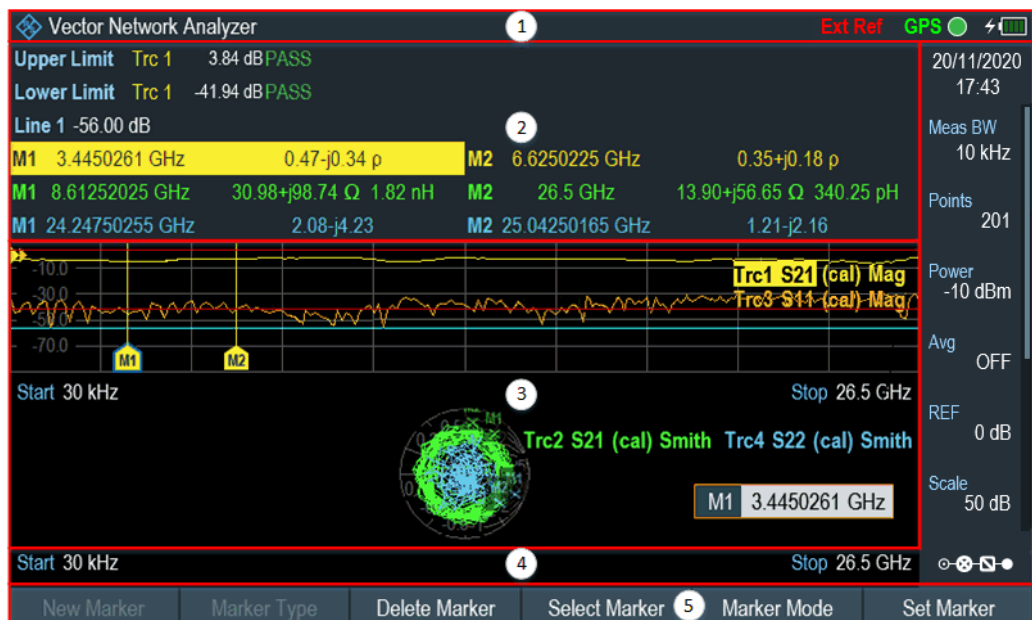

Figure 3-5: Display overview

- 1 = Title bar
- 2 = Measurement result view
- 3 = Measurement trace window
- 4 = Parameter view
- 5 = Softkey functions

---

**NOTICE****Risk of touchscreen damage during operation**

- Never touch the screen with ball point pens or other pointed objects with sharp edges.
  - It is recommended that you operate the touchscreen by finger only. As an alternative, you may use a stylus pen with a smooth soft tip.
  - Never apply excessive force to the screen. Touch it gently.
  - Never scratch the screen surface, e.g. with a finger nail. Never rub it strongly, for example with a dust cloth.
-

## 4 Basic operation

The following chapters provide an overview on the measurements that you can perform with the R&S ZNH.

- [Screen layout and elements](#).....31
- [Configuring the R&S ZNH](#).....39
- [Connecting the R&S ZNH to a PC](#).....52
- [Managing options](#).....59
- [Measuring transmissions](#).....62
- [Using a power sensor](#).....66
- [Saving and recalling results and settings](#).....70

### 4.1 Screen layout and elements

The following figure shows the screen layout in the vector network analyzer mode. Screen layouts that show the different operating modes or measurements are provided in the corresponding sections of this manual.

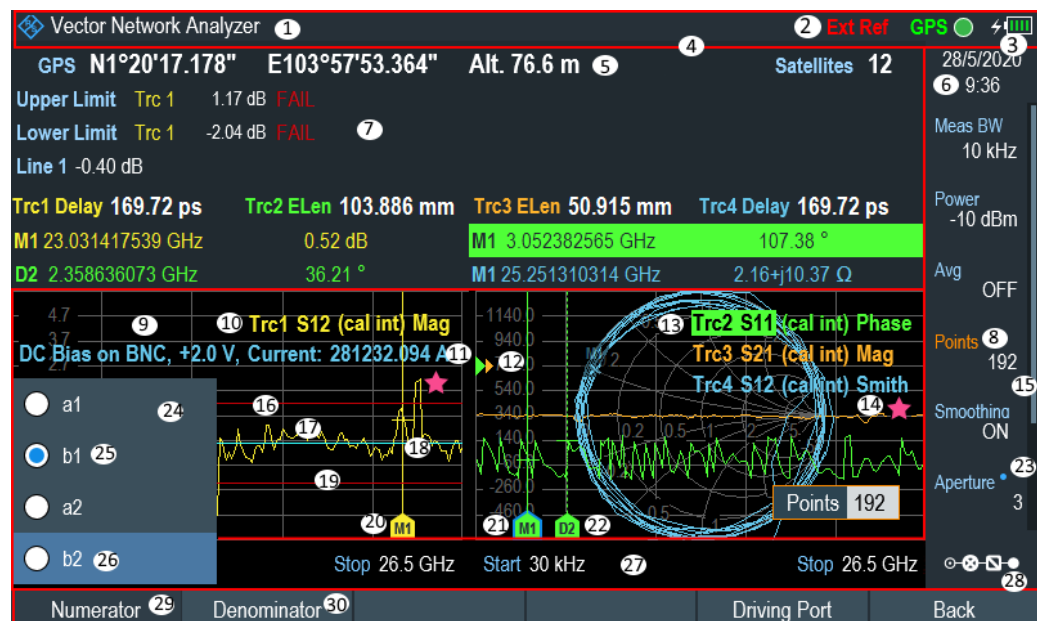

Figure 4-1: R&S ZNH screen layout

- 1 = Measurement information
- 2 = External reference, GPS and [signal source](#) status
- 3 = Battery status
- 4 = [Title bar](#)
- 5 = GPS information
- 6 = Date and time
- 7 = [Measurement result view](#)
- 8 = Currently selected button
- 9 = [Measurement trace window](#) (up to four can be displayed)
- 10 = [Trace label](#)

- 11 = [Internal DC bias connecting status](#)
- 12 = Reference position of trace measurement
- 13 = [Selected trace label](#)
- 14 = [Invalid trace indicator](#)
- 15 = Blue dot implies setting not coupled to another hardware setting
- 16 = Upper limit line threshold
- 17 = Trace measurement (up to four can be displayed)
- 18 = Display line
- 19 = Lower limit line threshold
- 20 = Marker
- 21 = Currently selected marker
- 22 = Delta marker
- 23 = Scrollbar for parameter view
- 24 = Available menu items
- 25 = Active menu item
- 26 = Current selected menu item
- 27 = [Parameter view](#)
- 28 = [Configuration overview](#)
- 29 = Selected softkey function
- 30 = Available softkey function

#### 4.1.1 Title bar

The title bar is located at the top of the screen layout.



It is used to display static content:

- Basic information such as R&S logo, measurement mode name (i.e. "Vector Network Analyzer", "Vector Voltmeter", "Power Meter"), external reference for frequency reference oscillator, GPS, signal source indicator and battery status
- Accessories name connected to the instrument, i.e power sensor
- Standard information such as cable model and channel table name

#### 4.1.2 Trace label

The trace label is displayed at the top-right corner of the [measurement trace window](#), it indicates the following:



- Trace selection status in vector network measurement (VNA) mode  
Selected trace is highlighted in the background
- Trace number in VNA mode (e.g. "Trc1", "Trc2", "Trc3", "Trc4")
- Trace measurement (e.g. "S21")
- [Calibration state](#) (e.g. "norm", "cal int")
- [Trace measurement format](#) (e.g. "Smith")



### 4.1.3 Measurement result view



#### Special touchscreen gesture

You can swipe vertically up or down in the measurement result view to hide or display the view.

The measurement result view is located below the [title bar](#).

GPS	N1°20'17.178"		E103°57'53.364"		Alt. 76.6 m		Satellites 12					
Upper Limit	Trc 1	1.17 dB	PASS	Trc 2	-12.77 dB	FAIL	Trc 3	7.14 dB	PASS	Trc 4	-14.03 dB	FAIL
Lower Limit	Trc 1	-2.04 dB	FAIL	Trc 2	-59.60 dB	FAIL	Trc 3	-55.36 dB	FAIL	Trc 4	-70.97 dB	FAIL
Line 1	-0.40 dB		Line 2	-25.33 dB		Line 3	-27.90 dB		Line 4	-36.00 dB		
M1	22.753930942 GHz		-2.97 dB		D2	-8.740827801 GHz		-8.15 dB				
M1	22.753930942 GHz		-2.97 dB		D2	-8.740827801 GHz		-8.15 dB				
M1	22.753930942 GHz		-2.97 dB		M1	22.753930942 GHz		-2.97 dB				

It displays measurement results of the following:

- GPS information
- Cable loss result in CAT mode
- Time delay and electrical length in VNA mode
- Display lines value and limit lines result (depends on measurement modes, up to four sets are displayed)
- Up to six marker values

When the marker is selected in the measurement result view, an entry box for marker positioning is displayed in the [measurement trace window](#). Selected marker is highlighted with a blue frame around the marker icon, see [Table 4-1](#).

**Table 4-1: Selected marker behavior**

Selected marker in the measurement result view	Selected marker in the measurement trace window
	<p>Note: A blue frame is shown around the selected marker icon, "M1".</p>

For more information on marker measurement, see [Chapter 8.5.2, "Using markers"](#), on page 187.

### 4.1.4 Measurement trace window

The measurement trace window is the main user interface window in the R&S ZNH. It displays the [trace label](#), internal DC bias status and measurement traces where markers and limit lines are positioned for measurement.

In VNA mode, the R&S ZNH provides up to four measurement traces in the displayed [measurement trace windows](#).

Each measurement trace is supported with the following:

- Reference position (index 12 of [screen layout](#)) of the trace measurement
- Up to six different markers
- Limits lines (upper and lower limits)
- Display line



#### Invalid trace indicator

The trace invalid indicator icon,  below the [trace label](#) indicates that the measurement is still in progress.

#### Multiple displays of measurement trace windows in VNA mode

1. Press [MODE] key.
2. Select "Network Analyzer" measurement mode.  
The R&S ZNH switches its operating mode.
3. Select "TRACE" softkey to display the trace measurement functions.
4. Select "Display" softkey.  
The R&S ZNH displays a submenu to select the display [combination](#) of measurement trace windows.
5. Select the desire combination.  
By default, the R&S ZNH displays the "S21" trace measurement in the added measurement trace window.

Table 4-2: Measurement trace window combination

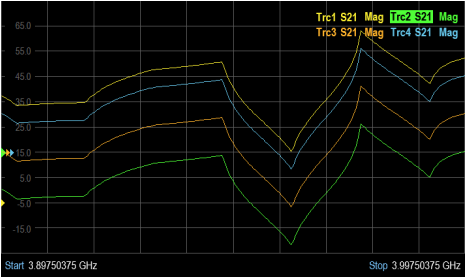
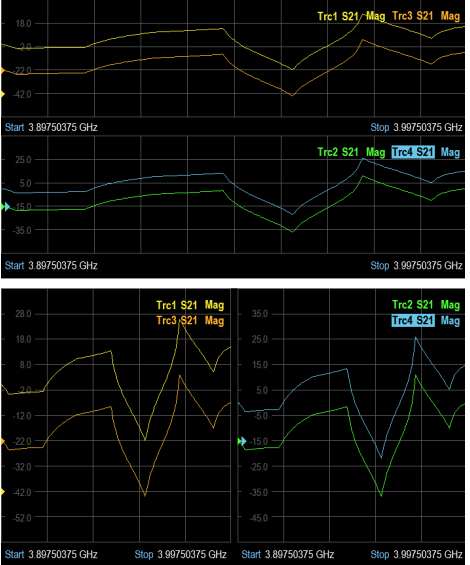
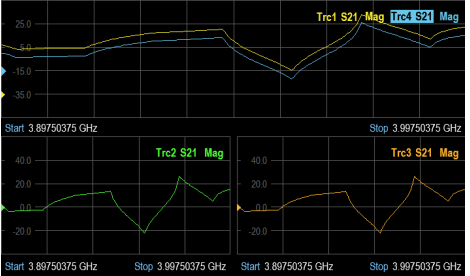
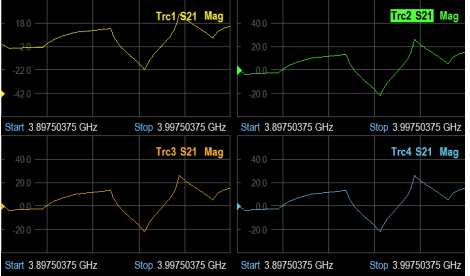
Types of measurement trace window display	
"Single" - single display	
"Dual-Hor" - dual horizontal display "Dual-Vert" - dual vertical display	
"Triple" - triple display	
"Quad" - quadrant display	

For more information of trace label, see [Chapter 8.3, "Performing vector network analysis measurements"](#), on page 163 and [Chapter 8.1.1, "Calibration states"](#), on page 155.

For information of the internal DC bias status, see ["Configuring the BIAS output port"](#) on page 41.





For information of markers, display line and limit lines, see [Chapter 8.5, "Analyzing measurement results"](#), on page 185.

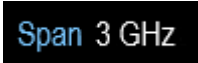

#### 4.1.5 Parameter view

The parameter view contains the important hardware parameters used in the measurement. It is operation mode dependent.

It is located at the right side and bottom section of the screen layout. See [Figure 4-1](#).

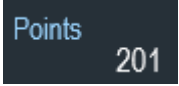
You can select any parameters in the "Parameter view" to adjust the configurations of the hardware settings. See details of each parameter in [Chapter 8.4.1, "Configuring the horizontal axis"](#), on page 179, [Chapter 8.4.2, "Configuring the vertical axis"](#), on page 179 and [Chapter 8.5.1, "Working with traces"](#), on page 186.

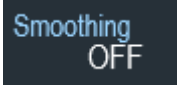
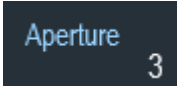
Parameter	Description
"Center", "Start", "Stop" 	Function-specific displays depending on the softkey indicated in the softkey label. It is used to configure one of the following: <ul style="list-style-type: none"> <li>Start, stop and center frequency for the measurement. See <a href="#">Chapter 8.4.1, "Configuring the horizontal axis"</a>, on page 179.</li> </ul>
"Span" 	Configure the frequency span of the measurement. See <a href="#">Chapter 8.4.1, "Configuring the horizontal axis"</a> , on page 179.
Time, date 	Display time and date of the instrument. This is a read-only field. See <a href="#">Chapter 4.2.3, "Configuring date and time"</a> , on page 43 and <a href="#">"Setting the date format"</a> on page 45.
"REF" 	Configure the reference level of the measurement. See <a href="#">Chapter 8.4.2.1, "Changing the reference value"</a> , on page 179.
"RBW" 	Configure the resolution bandwidth used for the measurement. See <a href="#">Chapter 8.4.4, "Setting the sweep parameters"</a> , on page 183.
"Points" 	Configure the number of measurement points. See <a href="#">Chapter 8.4.4.1, "Changing the number of measurement points"</a> , on page 184.

Parameter	Description
"Avg" 	Toggle the trace parameter to select the different trace mode ("OFF", "ON"). See <a href="#">Chapter 8.5.1, "Working with traces"</a> , on page 186.
"Suppr" 	Configure the smoothing mode to suppress signal resulting from interference source See <a href="#">Chapter 8.5.1.3, "Selecting suppressing interfering signals"</a> , on page 186.
"Aperture" 	Selectable only when smoothing mode is activated. Configure the aperture size used in the measurement. See <a href="#">Chapter 8.5.1.3, "Selecting suppressing interfering signals"</a> , on page 186.
"Config Overview" 	Display the configuration overview window for more configuration options used in the measurement. Configuration overview is operation mode dependent. See <a href="#">Chapter 4.1.6, "Configuration overview"</a> , on page 37.

#### 4.1.6 Configuration overview



There is a dedicated button located at the bottom right-hand corner of the parameter view. It is operation mode dependent. See [Figure 4-1](#).



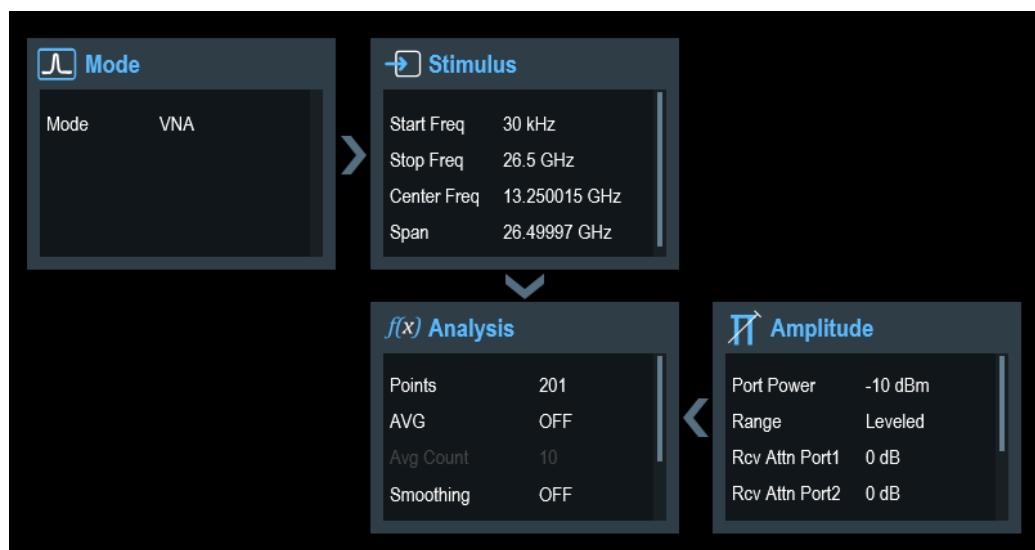

When you select this button, it opens the configuration overview window. Accessing it without the touchscreen input is possible via the [SETUP] key. See [Chapter 5.5, "Configuring measurements"](#), on page 84.



The configuration overview window illustrates here shows the flow of a vector network measurement (VNA) at different stages and the relevant parameters which have an impact on the measurement at each stage.

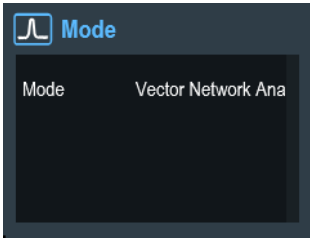

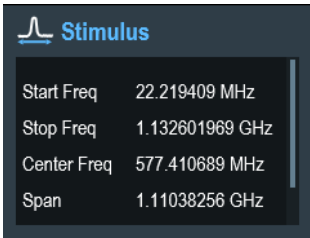
The configuration overview window is divided into six categories:

**Table 4-3: Corresponding dialog box of configuration overview window**

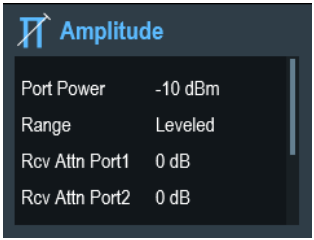
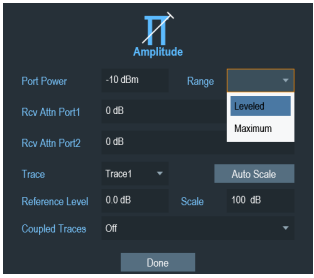
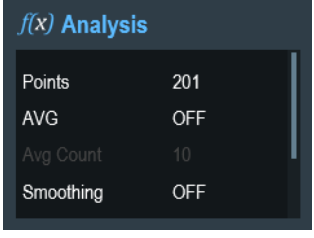
"Config Overview" block	Corresponding dialog box	Description
		<p>Select "MEAS" to load the available measurement modes (<a href="#">S-Parameters</a>, <a href="#">Wave</a>, <a href="#">Ratios</a> and <a href="#">Mixed modes</a>) to configure the desired <a href="#">trace format</a> and <a href="#">display combination</a> for the selected measurements.</p> <p>See <a href="#">Chapter 8.3, "Performing vector network analysis measurements"</a>, on page 163.</p>
		<p>Select "Stimulus" to configure the parameters related to the horizontal axis of the trace window.</p> <p>See <a href="#">Chapter 8.4.1, "Configuring the horizontal axis"</a>, on page 179.</p>

"Config Overview" block	Corresponding dialog box	Description
		<p>Select "Amplitude" to configure the parameters related to the <b>vertical axis (Range, Reference Level, Scale)</b> of the selected "Trace" ("Trace1", "Trace2", "Trace3", "Trace4"). To couple the vertical axis settings of different traces, select the "Coupled Traces" for configuration.</p> <p>You can also select the "Port Power" and "Rcv Att Port 1/2" to adjust the port power and receiver attenuation of the instrument. To adjust "Port Power" above -5 dBm, the "Range" should be set to "Maximum". By default, "Leveled" is set for "Range".</p> <p>See <a href="#">Chapter 8.4.2, "Configuring the vertical axis"</a>, on page 179.</p>
		<p>Select "Analysis" to determine the number of measurement points trace measurement mode.</p> <ul style="list-style-type: none"> <li>• If "AVG" is configured as "Average", the field "Avg Count" is available for configuration.</li> <li>• If "Smoothing" is set "On", the R&amp;S ZNH suppress signals resulting from interfering sources and the "Aperture" is available for configuration.</li> <li>• If "Aperture" is set to "Manual", the R&amp;S ZNH turns automatic aperture calculation off. The default aperture size is 1.</li> </ul> <p>See <a href="#">Chapter 8.5.1, "Working with traces"</a>, on page 186.</p>

## 4.2 Configuring the R&S ZNH

### SETUP

In the "Instrument Setup" dialog box, the R&S ZNH provides various general settings that are independent of the operating mode of the R&S ZNH.

1. Press [SETUP] key.
2. Select "Instrument Setup" softkey.  
A corresponding dialog box to configure the instrument opens.
3. Select the item you want to modify.

• Configuring the hardware.....	40
• Using the GPS receiver.....	41
• Configuring date and time.....	43
• Selecting regional settings.....	44
• Configuring the display.....	46
• Configuring the audio output.....	48
• Configuring power supply.....	49
• Configuring calibration kit model.....	50
• Resetting the R&S ZNH.....	51

### 4.2.1 Configuring the hardware

The hardware settings provide settings that control internal and connected hardware.

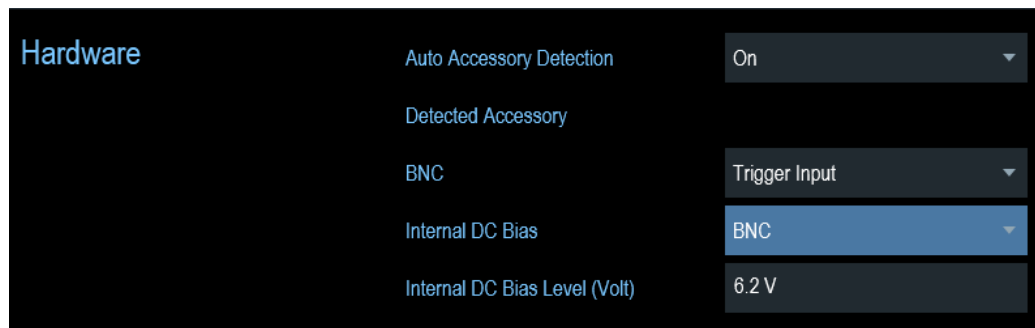

#### Using auto accessory detection

If you are using any accessories while working with the R&S ZNH, the instrument is able to identify the connected hardware. To enable this setting:

1. In the "Instrument Setup" dialog box, select the "Auto Accessory Detection" item. A drop-down menu to select the accessory detection opens.
2. Set "Auto Accessory Detection" to "On".  
When this feature is on, the name of the connected accessory is displayed in the "Detected Accessory" field.

#### Configuring the BNC connector

You can use the BNC connectors for various applications. For more information on the supported applications, see "[BNC connector](#)" on page 26.

1. In the "Instrument Setup" dialog box, select the "BNC" item.  
A drop-down menu to select the BNC connector application opens.



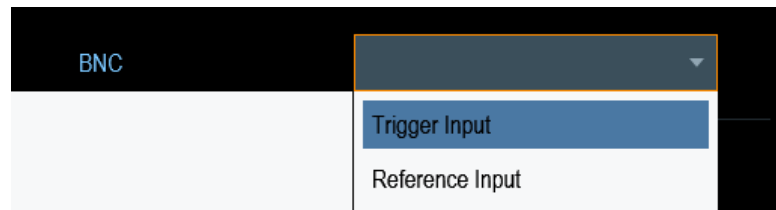

2. Select the required application.

### Configuring the BIAS output port



#### R&S ZNH option

R&S ZNH-K10 (order number 1334.6846.02) option is required for the BIAS output port.

You can supply direct current output via the RF out port or BNC connector. For more information on the supported applications, see [RF port 1 / RF port 2](#) and [BNC connector](#).

1. In the "Instrument Setup" dialog box, select the "Internal DC Bias" item. A drop-down menu to select the type of connector opens.

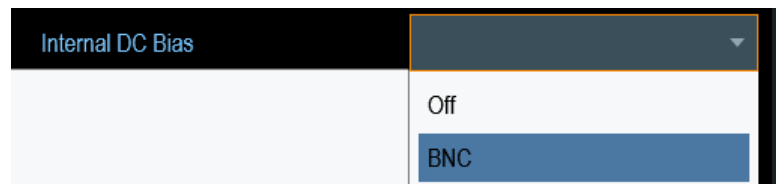

2. Select the desired connector.  
When the internal DC bias is activated, the status is displayed below the [trace label](#). The status consisting of connector setting, voltage and current level are shown. See [Chapter 4.1.4, "Measurement trace window"](#), on page 33.
3. Select the "Internal DC Bias Level (Volt)" item.
4. Enter the desired DC bias voltage.

## 4.2.2 Using the GPS receiver

The R&S ZNH can locate your exact position if you connect the GPS receiver (R&S HA-Z340, order number 1321.1392.02) to the USB connector.



### Location to secure GPS receiver (R&S HA-Z340)

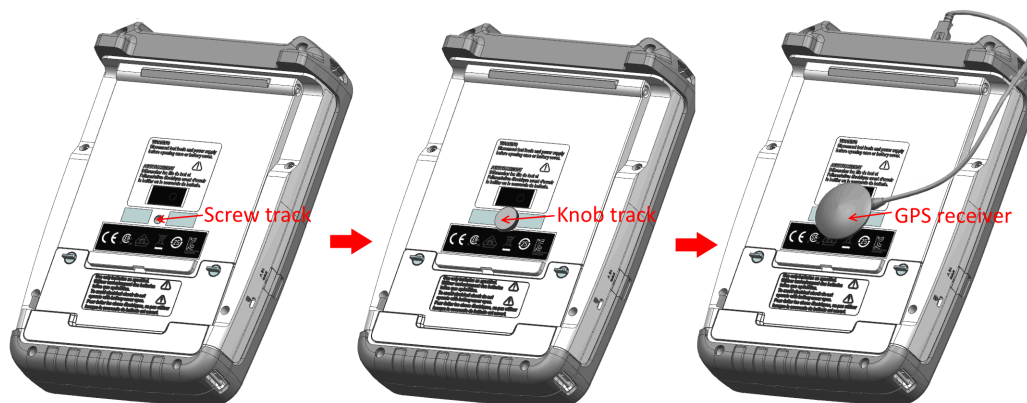
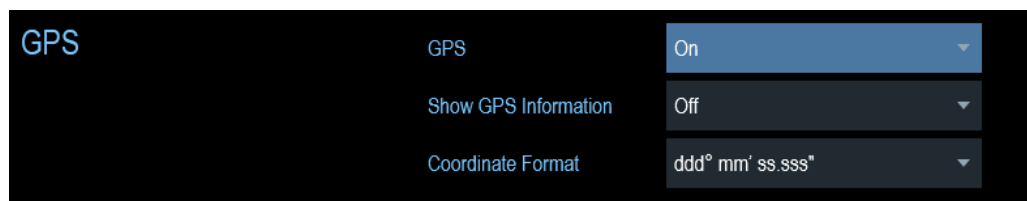

Figure 4-2: Location of GPS receiver

- Tighten the knob screw supplied with the GPS receiver to the screw track at the back of R&S ZNH.
- The GPS receiver can be conveniently attached to the knob screw as shown in [Figure 4-2](#).

The "Instrument Setup" dialog box provides all settings necessary to configure the GPS receiver.



### Enabling the GPS receiver

1. In the "Instrument Setup" dialog box, select the "GPS" item.  
A drop-down menu opens to turn the GPS receiver on or off.
2. Turn the GPS receiver on or off as required.

When "GPS" item is turned on, the R&S ZNH is ready to receive GPS data.

### Displaying GPS information

1. In the "Instrument Setup" dialog box, select the "Show GPS Information" item.  
A drop-down menu opens to turn the display of the GPS information on and off.
2. Turn the display of GPS information on or off as required.

When the "Show GPS Information" item is set on, the R&S ZNH displays the GPS coordinates and number of satellites in the [measurement result view](#) when sufficient connection is established to the GPS satellites.

GPS 1°20'20.022" N 103°57'53.238" E 52.5 m Satellites 9

When the satellite connection is lost, the GPS coordinates and number of satellites are displayed with a white bar.

GPS --- Satellites ---

When the GPS receiver is not connected or enabled, a message "GPS Not Connected" is displayed in the [measurement result view](#).

GPS Not Connected

### State of GPS receiver

The state of the GPS receiver locking to satellite is shown in the title bar is illustrated as follows.

- **GPS** indicates that the GPS receiver is enabled and that there is a fix connection with enough satellites for the GPS receiver to provide the coordinates.
- **GPS** indicates that the GPS receiver is enabled but that there is no fix connection to a satellite.
- **GPS** indicates that the GPS receiver is enabled but that there is no GPS receiver connection.
- The title bar shows no symbol if the GPS receiver is not enabled

### Selecting the coordinate format

1. In the "Instrument Setup" dialog box, select the "Coordinate Format" item. A drop-down menu opens to select the coordinate format.

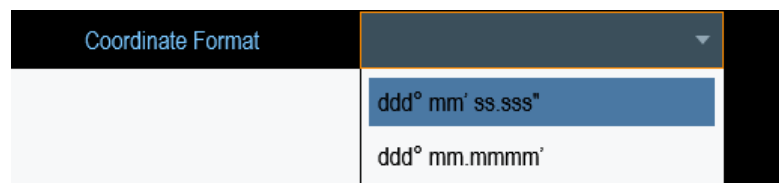

2. Select the coordinate format from the drop-down menu.

## 4.2.3 Configuring date and time

The R&S ZNH has an internal clock that can apply a date and timestamp. In the "Instrument Setup" dialog box, you can set both date and time.



### Setting the date

1. In the "Instrument Setup" dialog box, select the "Set Date" item.
2. Enter the date you want with the numeric keys. The sequence depends on the selected date format. See ["Setting the date format"](#) on page 45.



3. Confirm the entry with the rotary knob.

### Setting the time

1. In the "Instrument Setup" dialog box, select the "Set Time" item.
2. Enter the time you want with the numeric keys.



3. Confirm the entry with the rotary knob.  
After you have entered the time, the R&S ZNH verifies the validity of the time. If it is not a valid time, it sets to the next valid time.

### Selecting the time zone

1. In the "Instrument Setup" dialog box, select the "Time Zone" item.
2. Enter a positive or negative time offset relative to the system time with the numeric keys.



3. Confirm the entry with the rotary knob.  
After you have confirmed the time zone, the R&S ZNH adjusts the displayed time accordingly without changing the system time.

## 4.2.4 Selecting regional settings

The regional setting allows you to select a different language and date format.

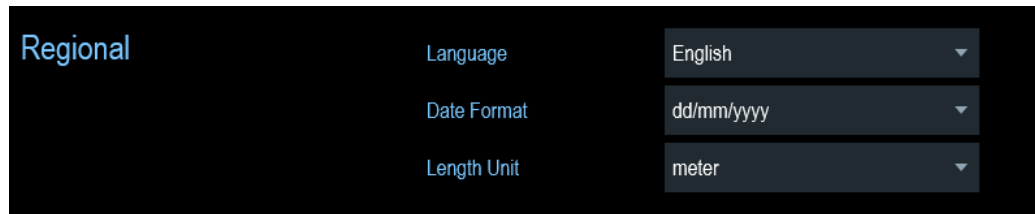

### Setting the language

The R&S ZNH supports several languages for the user interface.

The following is a list of languages that the instrument supports:

English	Spanish	Japanese	Russian
French	Italian	Chinese	Hungarian
German	Portuguese	Korean	Traditional Chinese

1. In the "Instrument Setup" dialog box, select the "Language" item. A drop-down menu opens to select the language.



2. Select the desired language from the drop-down menu.
3. Reboot the device to activate the choice of selected language.

### Setting the date format

The R&S ZNH provides two different formats to display the date.

1. In the "Instrument Setup" dialog box, select the "Date Format" item. A drop-down menu opens to select the date format.



2. Select the required date format from the drop-down menu.

### Setting the length unit

The R&S ZNH provides two different formats to configure the cable length unit.

1. In the "Instrument Setup" dialog box, select the "Length Unit" item. A drop-down menu opens to select the length unit.



2. Select the length unit from the drop-down menu.

## 4.2.5 Configuring the display

The display setting configures the display characteristics and the touch interface.

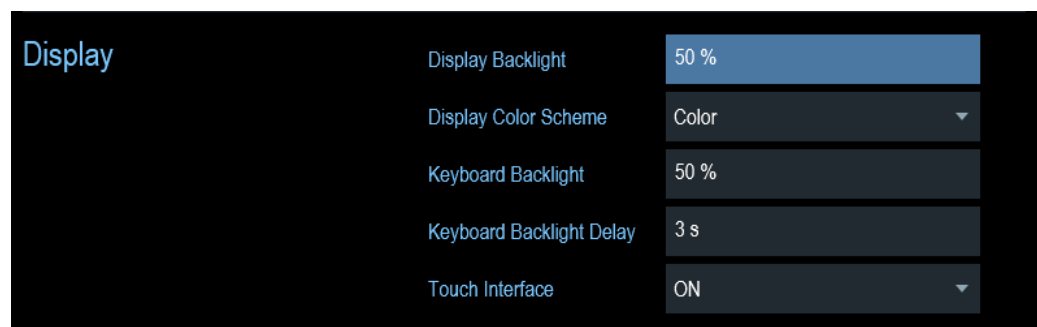

The display of the R&S ZNH is a TFT color LCD display.

The ideal brightness of the display depends on the intensity of the backlight. To strike a balance between battery operating time and screen display quality, set the backlight intensity to the minimum brightness needed.

To optimize the viewing angle, adjust the display color scheme settings. To achieve the maximum contrast, the screen can be switched from color display to black-and-white display.

The intensity of the keyboard backlight is adjustable with a time delay setting to turn off the backlight. The keyboard backlight remains on until the time specified by the "Keyboard Backlight Delay" or a subsequent key is pressed.

### Adjusting the display backlight

1. In the "Instrument Setup" dialog box, select the "Display Backlight" item.
2. Enter the backlight intensity you want with the numeric keys.



The backlight intensity is a percentage from 0% to 100% with 100% being the brightest.

3. Confirm the entry with the rotary knob.

### Adjusting the display color scheme

1. In the "Instrument Setup" dialog box, select the "Display Color Scheme" item. A drop-down menu opens to select the display color scheme.

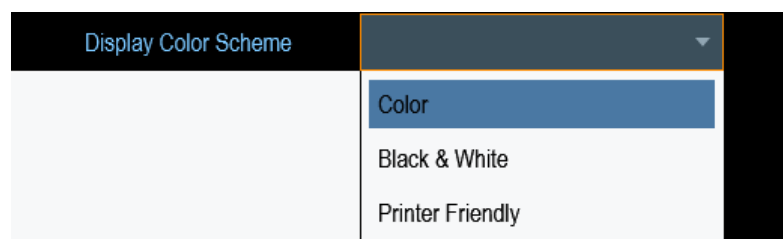

2. Select the color scheme from the drop-down menu.
  - a) "Color" selects a color display.
  - b) "Black & White" selects monochrome display.
  - c) "Printer Friendly" inverts the colors.

### Adjusting the keyboard backlight

1. In the "Instrument Setup" dialog box, select the "Keyboard Backlight" item.
2. Enter the backlight intensity you want with the numeric keys.



The backlight intensity is a percentage from 0% to 100% with 100% being the brightest.

3. Confirm the entry with the rotary knob.

### Adjusting the keyboard backlight delay

1. In the "Instrument Setup" dialog box, select the "Display Backlight" item.
2. Enter the time you want to turn off the keyboard backlight with the numeric keys.



The time delay has a range of 1s to 10s.

3. Confirm the entry with the rotary knob.

### Activating the touchscreen interface

1. In the "Instrument Setup" dialog box, select the "Touch Interface" item.
2. Select "ON" to activate the touchscreen interface with R&S ZNH.

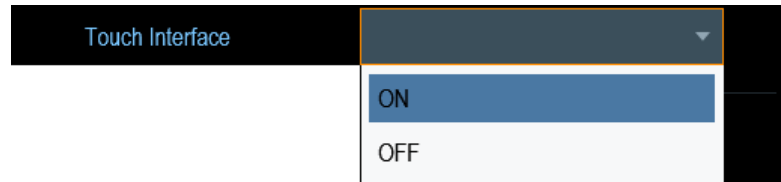

3. Select "OFF" to deactivate the touchscreen interface.  
Note: If the touch interface is not activated, the [On-screen keyboard](#) is disabled.

## 4.2.6 Configuring the audio output

The audio settings control the audio output of the system.

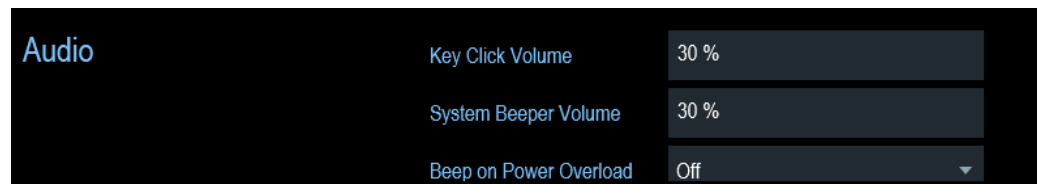

### Setting the key click volume

The key click volume sets the volume of the sound that the R&S ZNH produces when you press a key or select a softkey.

1. In the "Instrument Setup" dialog box, select the "Key Click Volume" item.
2. Enter the volume you want with the numeric keys.



The key click volume is a percentage from 0% to 100% with 100% being the loudest.

3. Confirm the entry with the rotary knob.

### Setting the system beeper volume

The system beeper volume sets the volume of the system beeper of the R&S ZNH used, i.e. if a message box pops up.

1. In the "Instrument Setup" dialog box, select the "System Beeper Volume" item.



2. Enter the volume you want with the numeric keys.



The system beeper volume is a percentage from 0% to 100% with 100% being the loudest.

3. Confirm the entry with the rotary knob.

### Activating / Deactivating audio alert for power overload

In case the R&S ZNH detects an overload at one of its inputs, you can configure the alert audible.

1. In the "Instrument Setup" dialog box, select the "Beep on Power Overload" item.
2. Select "Beep on Power Overload" to "On".  
When this beeper turns on, the R&S ZNH makes a sound every time it detects an overload.



## 4.2.7 Configuring power supply

The "Current Power Source" shows the source that the R&S ZNH is powered by.

When you are using the battery to power up the R&S ZNH, the remaining "Battery Level" is displayed as a percentage with 100 % representing a full charge.

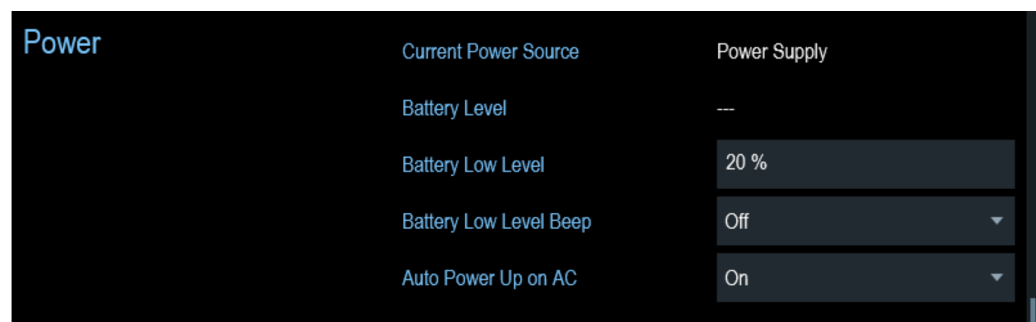

### Setting the battery low level

The battery low level is a reminder that the remaining battery charge might be used up soon.

When the battery low level is reached, the battery symbol in the [title bar](#) turns red and starts blinking. See [Chapter 3.1.1.5, "Battery operation"](#), on page 20.

1. In the "Instrument Setup" dialog box, select the "Battery Low Level" item.

2. Enter the charge level in percent of a fully charged battery with the numeric keys.



3. Confirm the entry with the rotary knob.

### Activating / Deactivating audio alert for battery low-level state

The R&S ZNH also allows you to turn on an audio signal that indicates that the battery has reached its low-level state.

1. In the "Instrument Setup" dialog box, select the "Battery Low Level Beep" item.

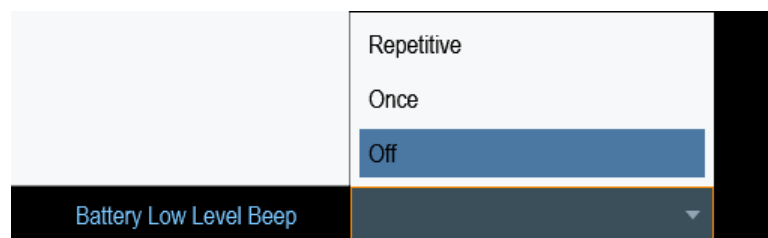

2. Select either "Repetitive" or "Once" to turn on the audio signal.  
If you have selected "Once", the R&S ZNH beeps once if the battery runs out of power. For a continuous beep, select "Repetitive".
3. Select "Off" to turn off the beeper.

### Auto power up

The R&S ZNH allows you to auto power up the instrument when supplying with an AC power, without pressing the [POWER] key button.

1. In the "Instrument Setup" dialog box, select the "Auto Power Up on AC" menu item.



2. Select "On" to turn on the auto power up mode.  
On the next power up cycle, the R&S ZNH goes into the auto power up mode when supplying with an AC power.

## 4.2.8 Configuring calibration kit model

The calibration kit setting loads the selected calibration kit model from the file manager. For a list of supported calibration kits model by the R&S ZNH, see [Chapter 8.1.2, "Calibration methods"](#), on page 156.

1. In the "Instrument Setup" dialog box, select the "Calibration Kit" item.

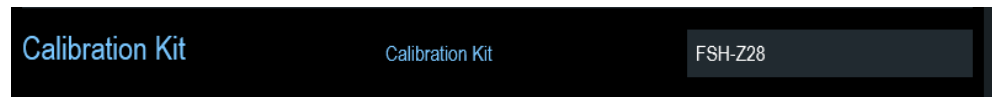

The R&S ZNH opens a file manager dialog to select the calibration kit model.

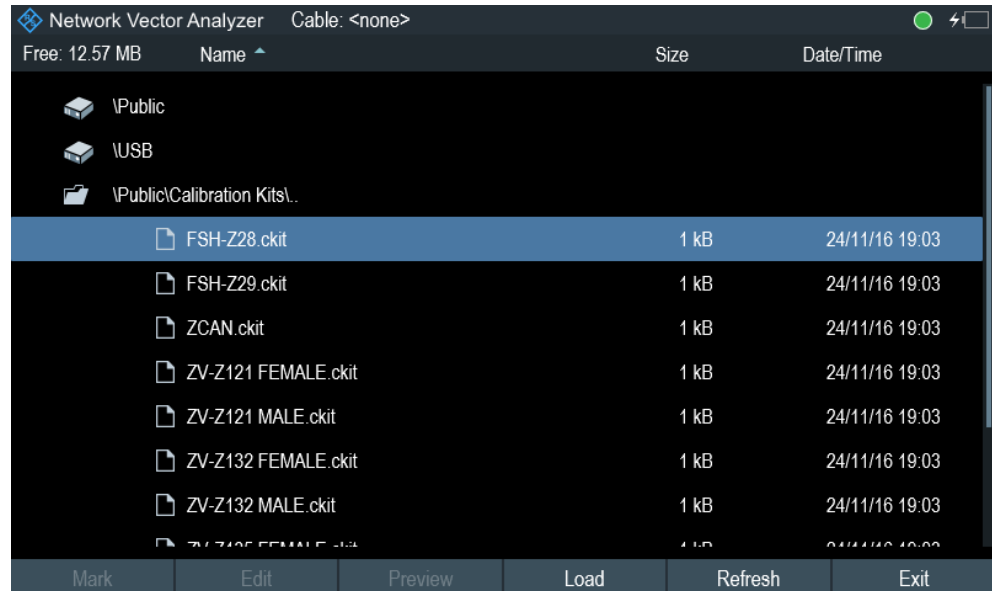

2. Select the calibration kit model that you require.

The R&S ZNH loads the selected calibration kit model which is taken in for consideration during the calibration.

For more information, see [Chapter 8.1.2, "Calibration methods"](#), on page 156 and [Chapter 7.1.9.3, "Calibration kit"](#), on page 128.

You can also define new calibration kit models with the R&S InstrumentView software and then transfer them to the R&S ZNH. For more information on creating the calibration kit models, refer to the documentation of the R&S InstrumentView software package.

## 4.2.9 Resetting the R&S ZNH

You can either preset the R&S ZNH or reset it to factory settings.

### Presetting the R&S ZNH

The [PRESET] key resets the R&S ZNH to the default setup of the currently active operating mode.

This default setup allows you to define the instrument with a new configuration based on a defined measurement parameter without using parameters from a previous measurement unintentionally still being active.

- ▶ Press the [PRESET]  key.

### Resetting the R&S ZNH

A "Reset to Factory Settings" resets the R&S ZNH to the factory defaults.

During a reset, the R&S ZNH restores the original configuration. It also deletes all customized datasets (limit lines, standards, channel tables, transducer tables etc.). Instead, it will reinstall all the datasets that have been available after delivery.



#### Risk of data loss

All datasets you have saved are deleted during a factory reset.



#### Calibration data

After a factory reset, the R&S ZNH is loaded with the default factory calibration data. See [Chapter 8.1.1, "Calibration states"](#), on page 155.

1. In the "Instrument Setup" dialog box, select the "Reset to Factory Settings" item.
2. Confirm the entry with the rotary knob.



The R&S ZNH initiates the reset procedure and shows a warning message box.

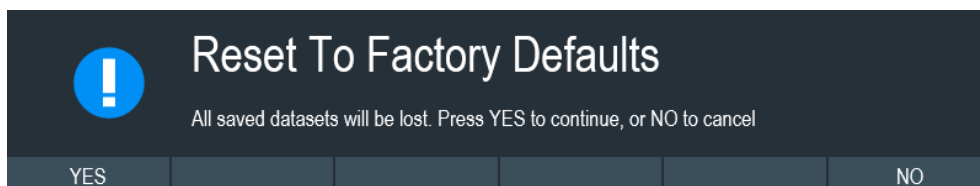

3. A corresponding dialog box opens for selection.
  - Select "Yes" to perform the reset. During the reboot, it shows a corresponding message.
  - Select "No" to cancel the reset.

## 4.3 Connecting the R&S ZNH to a PC

The R&S ZNH comes with the R&S InstrumentView software package. This software package features several tools that allow you to document measurement results, create and edit the different datasets necessary for the instrument. For more information, see the R&S InstrumentView software manual.

The .NET Framework 2.0 (or higher) is required to run the software properly.

You have to install the R&S InstrumentView software on the PC before you are able to establish a connection.

Download the latest R&S InstrumentView from <http://www.rohde-schwarz.com/product/znh.html>.



### Firewall settings

If no connection can be established between the software and the R&S ZNH after successful configuration, check the firewall settings on your PC.

- [LAN connection](#).....53
- [USB connection](#)..... 58

## 4.3.1 LAN connection

You can connect the R&S ZNH directly to the PC with a LAN cable. The **LAN port** is located behind a protective cap on the right side of the R&S ZNH.

You can set up the LAN connection in the "Instrument Settings" dialog box.

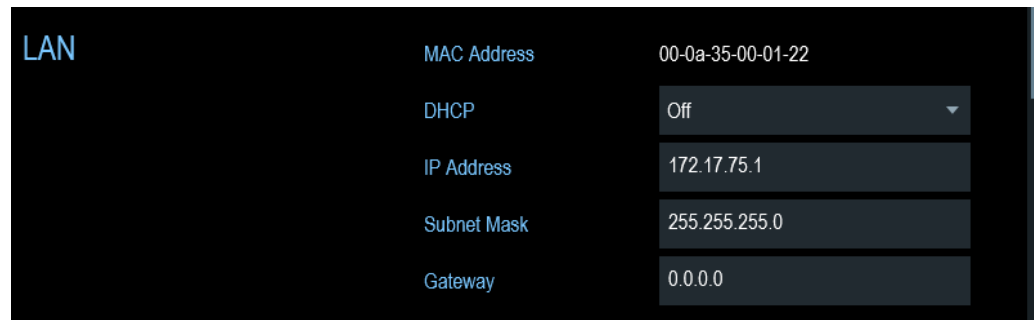

For a direct connection between the PC and R&S ZNH, the DHCP (Dynamic Host Configuration Protocol) of the R&S ZNH has to be turned off (which is the default state).

1. In the "Instrument Settings" dialog box, select the "DHCP" item. A drop-down menu opens to select the DHCP state.
2. Select "DHCP" to "On" or "Off" as required.

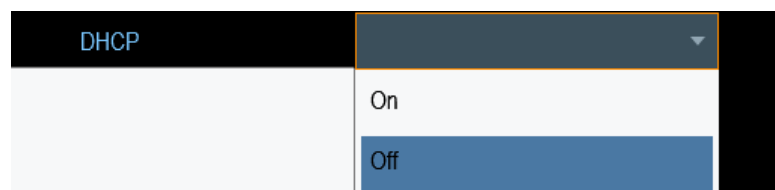

### Setting an IP address and subnet mask

To establish a connection, the PC and R&S ZNH have to be in the same subnet.

#### Subnet mask

1. Identify the subnet mask of your PC, i.e. in the Microsoft Windows "TCP/IP Properties".

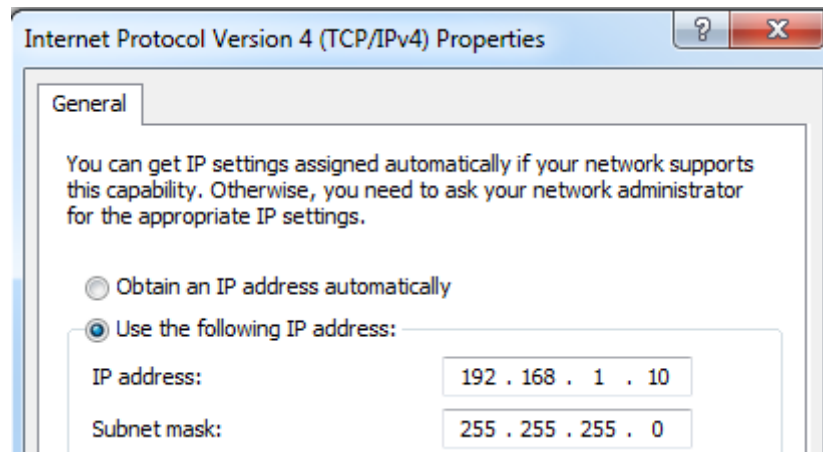

2. In the "Instrument Settings" dialog box, select the "Subnet Mask" item.
3. Enter the subnet mask of the PC with the numeric keys.



After you have matched the subnet mask, you can define the IP address. When both devices are in the same subnet, the first three digits of the IP address are usually the same. See example below:

**Example:**

IP address for PC: 192.168.1.10

IP address for R&S ZNH: 192.168.1.20

**IP address**

1. Identify the IP address of your PC, i.e. in the Microsoft Windows "TCP/IP Properties".

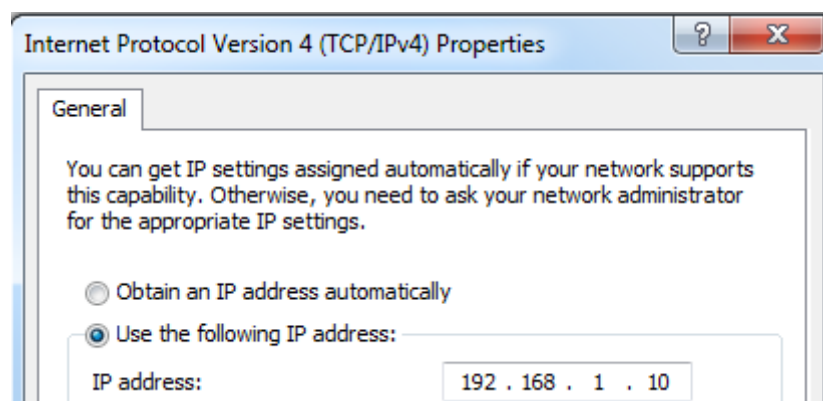

2. In the "Instrument Settings" dialog box, select the "IP Address" item.
3. Confirm the entry with the rotary knob.



4. Enter the IP address of the PC with the numeric keys.



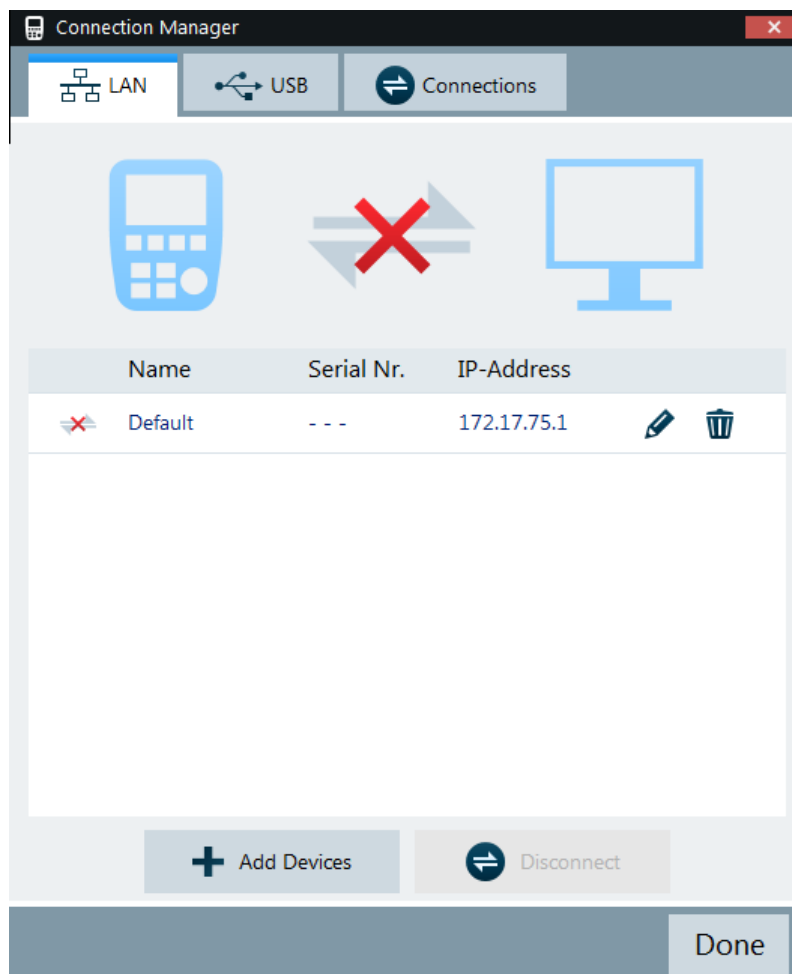

### Configuring the R&S InstrumentView software package

1. Start the R&S InstrumentView software.
2. Select the "LAN" tab in the screen layout.

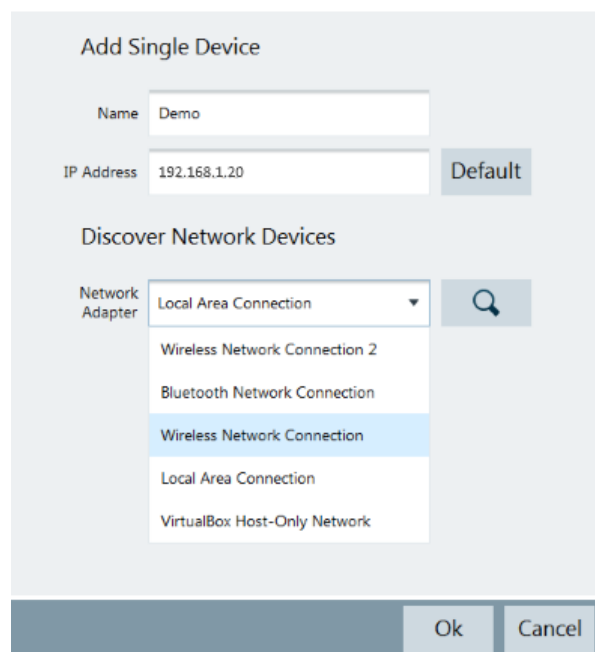

3. During the initial startup, the "IP-Address" field is set to default "172.17.75.1". You can edit the IP address using the   icons
4. Select the "Add Devices" button to create a new network connection.



5. Specify a name and the IP address for the new network connection.
6. Select "Local Area Connection" for the "Network Adapter".
7. Confirm the entry with the "OK" button to add the new instrument to the connection manager list.
8. Depending on the connection status icon,   you can connect or disconnect an instrument from the connection manager list



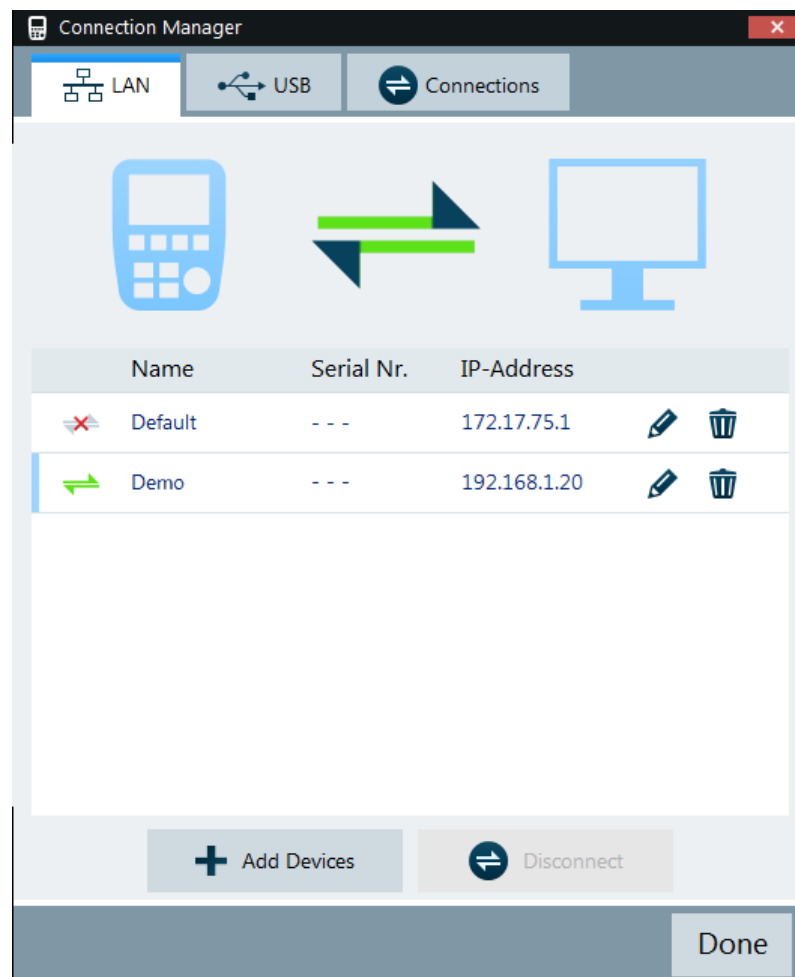

### Connecting the R&S ZNH in an existing LAN

You can either get the R&S ZNH IP address automatically from the DHCP server or manually assign a fixed address.

With manual allocation, a fixed IP address and subnet mask must be assigned to the R&S ZNH as described in [Chapter 4.3.1, "LAN connection"](#), on page 53. After setting up the R&S ZNH, configure the R&S InstrumentView software with the assigned IP address as described in ["Configuring the R&S InstrumentView software package"](#) on page 55.



#### Free IP address

Contact your IT system administrator to get a free IP address.

In networks with a DHCP server, the DHCP permits automatic allocation of the network configuration to the R&S ZNH connected via LAN cable. For this purpose, the DHCP has to be active on the R&S ZNH.

The DHCP is off by default. Turn it on like this:

1. In the "Instrument Setup" dialog box, select the "DHCP" item.
2. Select "DHCP" to "On" to activate the DHCP.

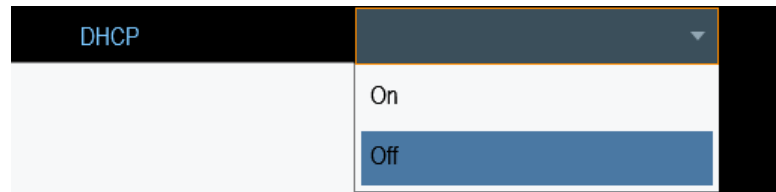

The R&S ZNH is now allocated an IP address and the subnet mask by the DHCP server. This can take several seconds.

The IP address and subnet mask are automatically set in the corresponding input fields and are no longer available for editing.



Configure the R&S InstrumentView software with the IP address and subnet mask as defined by the DHCP server. For more information, see [Chapter 4.3.1, "LAN connection"](#), on page 53.

### 4.3.2 USB connection

Alternatively, you can connect the R&S ZNH to the PC with a USB cable. The [mini USB interface](#) is located behind a protective cap on the right side of the R&S ZNH.

When you connect the R&S ZNH to a computer for the first time, Windows tries to install the new hardware automatically. The required drivers are installed along with the R&S InstrumentView software package.

When the drivers have been found on your system and the hardware has been successfully installed, Windows shows a corresponding message.

1. Connect the R&S ZNH via the mini USB port to your computer.
2. Start the R&S InstrumentView on the PC.
3. There is only one USB instance in the connection manager list. See [Figure 4-3](#). Depending on the connection status icon,   you can connect or disconnect an instrument from the connection manager list

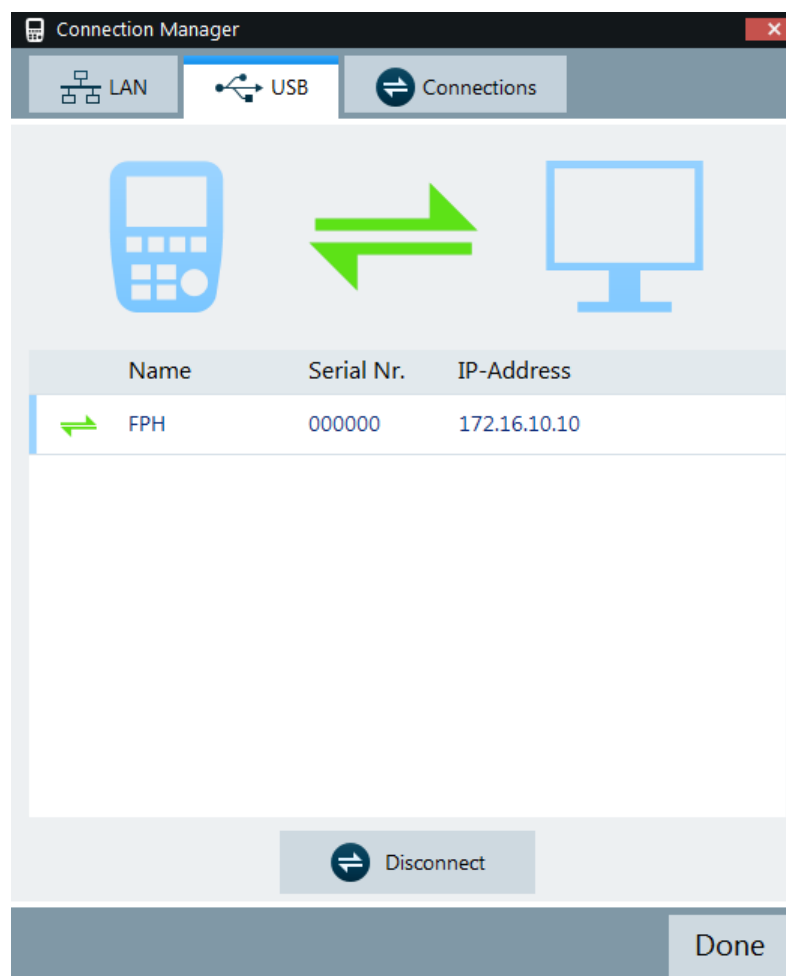

Figure 4-3: USB connection

## 4.4 Managing options

For special measurement tasks, you can equip the R&S ZNH with various firmware options.

### 4.4.1 Enabling options

To enable options, you have to enter a key code. The key code is based on the unique serial number of the R&S ZNH.

1. Press [SETUP] key.
2. Select "Installed Options" softkey.  
A list of all available options and the current status of the options is displayed. See [Figure 4-4](#).

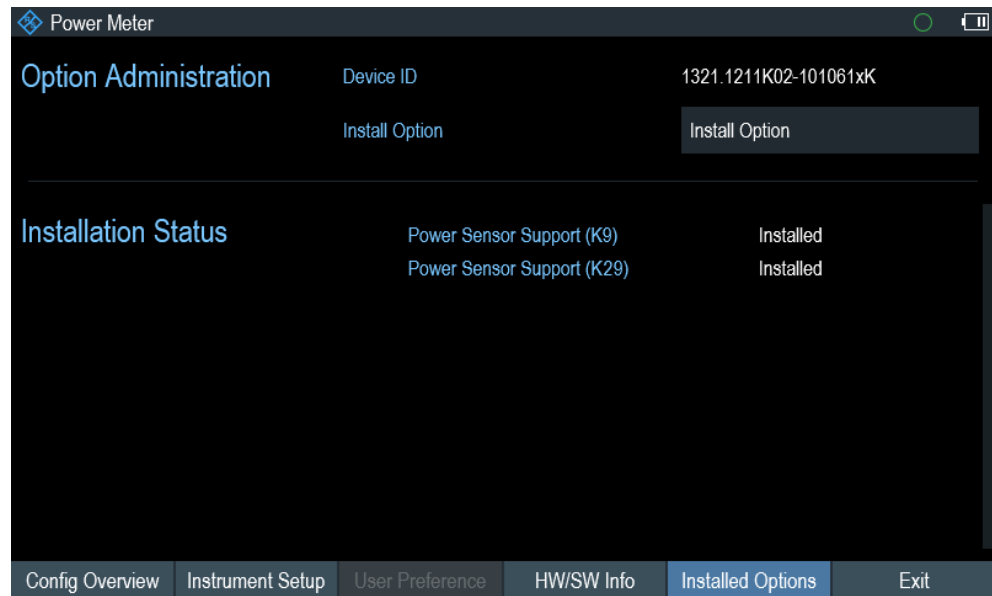

**Figure 4-4: Installed option**

3. Select the "Install Option" menu item from the dialog box.  
The R&S ZNH opens an entry field to enter the option key.
4. Enter in the appropriate option key.
5. Confirm the entry with the rotary knob.  
If you have entered the correct code, the instrument displays a "installation successful" message.  
If incorrect code is entered, the instrument displays a "invalid key code!" message.
6. Enter the correct code again.

#### 4.4.2 Checking options

In the "Setup" menu, the R&S ZNH shows all options that are currently installed.

1. Press [SETUP] key.
2. Select "Installed Options" softkey.  
The R&S ZNH shows a list of all available options and the current status of the option:
  - "Installed": This means that the option is installed and working.
  - "Demo": This means that the option is for demo purposes and it has an expiry date.
  - "Removed:<option key>": This indicates that a portable license has been removed and is ready to be transferred to another R&S ZNH.

### 4.4.3 Managing options with R&S license manager

If you are using the R&S ZNH in a local area network (LAN), you can manage the firm-ware options with a web browser (e.g. Microsoft Internet Explorer or Mozilla Firefox).

For more information on connecting the R&S ZNH to a LAN, see [Chapter 4.3.1, "LAN connection"](#), on page 53.

After you have connected the R&S ZNH, open your web browser.

1. Enter the IP address of the R&S ZNH in the address bar of the web browser.



The browser accesses the R&S License Manager. In this part of the R&S License Manager, you can install and activate licenses on the R&S ZNH.

This page features three areas:

- The first area shows the details of the connected device including the device ID and the IP address.

#### Connected Device

<b>FPH</b>	<b>Device ID:</b>	<b>1321.1111K02-900188-nK</b>
<b>FPH</b>	<b>IP Address:</b>	<b>10.113.10.184</b>
<b>Version: V1.00</b>	<b>Host Name:</b>	<b>localhost</b>

- The second area provides functionality to install and activate licenses.

#### What do you want to do?

- [Install Registered License Keys and Activate Licenses](#) ?
- [Register Licenses, Install License Keys and Activate Licenses](#) ?
- [Reboot Device](#) ?

- "Install Registered License Keys and Activate Licenses"  
Follow this link if you have purchased a registered license. Registered licenses only work in combination with a specific device ID.
- "Register Licenses, Install License Keys and Activate Licenses"  
Follow this link if you have purchased an unregistered license. Unregistered licenses are not connected to a specific device ID.
- "Reboot Device"  
Follow this link to reboot the R&S ZNH.
- Online help icon ?  
Opens a detailed online help to the corresponding topic.
- The third area provides hints on using the license manager when you move the mouse over one of the options.

#### Help

##### Reboot Device:

Many devices need to be rebooted, before newly installed license keys can activate the licenses on these devices. Use "Reboot Device" to allow the R&S License Manager to remotely reboot a device, which is accessible via LXI. You will be requested to select the Device ID of the applicable device.

If you already have one or more R&S ZNH equipped with options, you can manage the licenses of these options on the license manager web page.

2. Select the **Manage Licenses** button.

The browser accesses another part of the R&S License Manager. In this part of the license manager, you can manage licenses already installed on your R&S ZNH.

This page features two areas:

- The first area provides functionality to manage licenses already installed on a device.

#### What do you want to do?

- [Register Licenses](#) 
- [Unregister License](#) 
- [Move Portable License](#) 

- "Register Licenses"  
Follow this link if you have purchased an unregistered license. Unregistered licenses only work in combination with a specific device ID.
- "Unregister License"  
Follow this link if you have installed a portable license. Portable licenses work in combination with several device IDs. However, you have to unregister it on one device before you can use it on another.
- "Move Portable License"  
Follow this link if you want to move a portable license. Moving a portable license is possible without unregistering the license.
- Online help icon   
Opens a detailed online help to the corresponding topic.
- The second area provides hints on using the R&S License Manager when you move the mouse over one of the options.

After you have followed one of the links, follow the instructions displayed in the browser. If you encounter any problems during the licensing procedure, you can access the online help at any time with the online help icon . The online help contains an extensive description of all functionality that the license manager features.

## 4.5 Measuring transmissions

This measurement example measures the transmission characteristics of a lowpass filter in the VNA mode. The filter works in the frequency from 10 MHz to 200 MHz.

### Test setup

To measure the transmission:

- Connect the input of the filter to the generator output (RF port 1).
- Connect the output of the filter to the RF input (RF port 2).

### Preset the R&S ZNH

Before starting the measurement procedure, preset the R&S ZNH to restore the default configurations and connect the filter between the measurement ports.

- Press the [PRESET] key.
- Connect the filter between the measurement ports.

### Setting the frequency span

Before calibrating the R&S ZNH, you should define the frequency range of the filter.

1. Select the [FREQ/DIST] key.
2. Select the "Start" softkey.  
The R&S ZNH opens an input field to specify the start frequency.
3. Enter 10 MHz as the start frequency.  
The R&S ZNH adjusts the frequency range accordingly.
4. Select the "Stop" softkey.  
The R&S ZNH opens an input field to specify the stop frequency.
5. Enter 200 MHz as the stop frequency.  
The R&S ZNH adjusts the frequency range accordingly.

Note that the distance from start to stop frequency has to be equal to the span. The R&S ZNH adjusts the values if you enter a frequency range that is not the same as the span.

### Calibrating the measurement

For transmission measurements, you have to perform a 2-port normalization (e.g. "Trans Norm P1") to get the best results.

1. Press the [CAL] key.
2. Select the "Calibrate > Cal Config" softkey.  
The R&S ZNH displays the calibration configuration dialog box for selecting the measurement ports, calibration method and calibration kit.  
See [Figure 8-2](#).
3. Select "Port1" and "Port2" for the calibration port.
4. Select the calibration method, "Trans Norm P1" for the "Through" calibration from "Port1" to "Port2".
5. Select the desired calibration kit.  
The R&S ZNH open the file manager to load the available calibration kits.
6. Select "Apply" to confirm the calibration configurations.
7. Select "Calibrate" to proceed the normalization calibration from "Port1" to "Port2".  
The R&S ZNH displays a pop-up message on the calibration configurations.

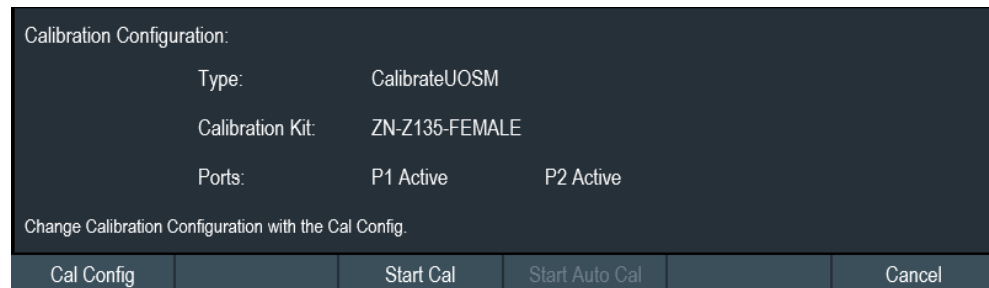

To change the calibration configurations, select "Cal Config" again.

8. Select "Start Cal" to start the calibration.  
The R&S ZNH displays the selected calibration procedure, "Through" for "P1<>P2" path.
9. Firmly connect a "Through" connection on both RF ports.
10. Proceed with "Through" to start the normalization calibration from "Port1" to "Port2".  
After finishing the calibration routine, the R&S ZNH highlights the "Through" in blue.

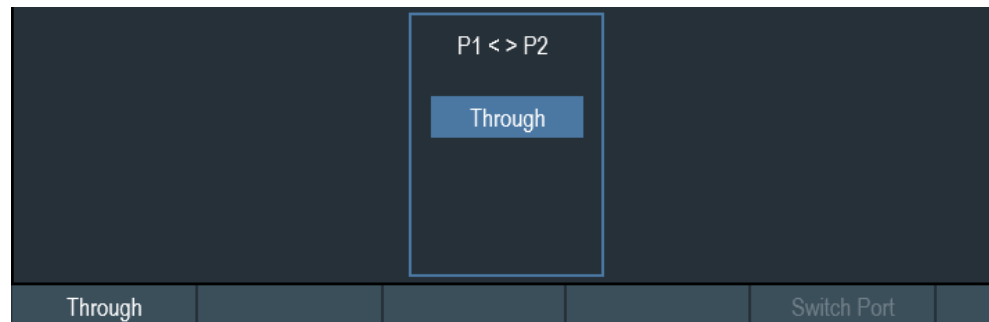

The R&S ZNH is now calibrated and a "(norm)" status is displayed next to the measurement format, i.e. **S21 (norm) Mag**. See [Chapter 3.2.6, "Display overview"](#), on page 29.

#### 4.5.1 Transmission measurement

Reconnect the filter to the measurement ports of the R&S ZNH.

1. Press the [MODE] key.
2. Select the "Vector Network Analyzer" softkey.  
The R&S ZNH switches its operating mode.
3. Press the [MEAS] key.
4. Select the "S21" or "S12" softkey for transmission measurements in forward or reverse direction  
For more information on multiple displays, see ["Multiple displays of measurement trace windows in VNA mode"](#) on page 34.



The R&S ZNH now shows the (corrected) characteristics of the lowpass filter.

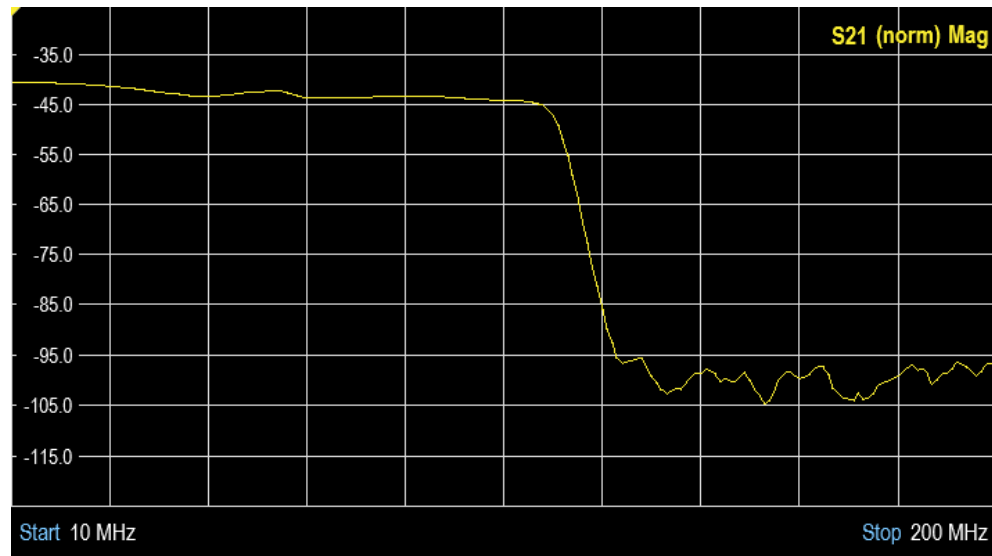

## 4.5.2 Reflection measurement

In a reflection measurement, the R&S ZNH transmits stimulus signal to the input port of the device under test (DUT) and measures the reflected wave. Different [trace formats](#) allow you to express and display the results. Only one analyzer test port is required for the reflection measurements.

In principle, the reflection measurement involves the same steps as a [transmission measurement](#). Note on the following differences:

- The basic test setup for reflection measurements involves a single DUT and analyzer port. You connect the input of your DUT to port 1 of the R&S ZNH.
- Using the basic [transmission test setup](#), you can measure and display reflection and transmission measurements in parallel. For more information, see [Chapter 8.3.1, "S-Parameter measurements"](#), on page 164.
- Choose the appropriate [calibration configuration](#) for reflection measurement. A full two port calibration type ("TOSM" or "UOSM") corrects the system errors for all transmission and reflection S-parameters.
- Some of the [trace formats](#) are particularly suited for reflection measurements. For instance, you can display the measured reflection coefficient,  $S_{11}$  in a smith chart to obtain the complex input impedance at port 1.

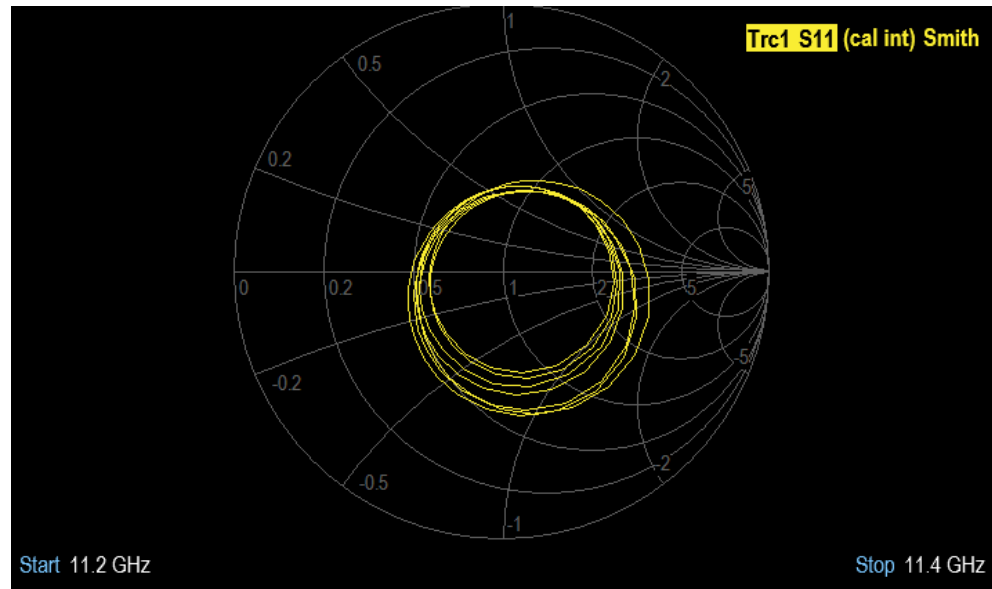

## 4.6 Using a power sensor



### R&S ZNH option

R&S ZNH-K9 (order number: 1334.6800.02) option is required to operate the R&S ZNH in the power sensor mode.

For highly accurate power measurements, you can connect one of the power sensors that are supported by the R&S ZNH.

For a list of R&S ZNH supported power sensors, see the datasheet of the R&S ZNH.

You can connect the list of supported power sensors to the USB port of the R&S ZNH. This connector allows you to control the power sensor and supplies it with power. For more information, see "[USB type A connector](#)" on page 27.

### 4.6.1 Measuring the power with a power sensor

For more information about the characteristics of the supported power sensors, refers to their datasheet.

**NOTICE****Risk of damaging the power sensor**

Because of high input power,

- The continuous power applied to the power sensor's input must not exceed 400 mW (26 dBm).
- Use an attenuator for measurements on high-power transmitters.

However, brief power peaks  $\leq 10 \mu\text{s}$  up to 1 W (30 dBm) are permissible.

**Test setup**

Connect the power sensor cable to the USB port of R&S ZNH. If the power sensor is having the binder connector (i.e R&S FSH-Z1, R&S FSH-Z18), the FSH-Z101 adaptor cable is needed.

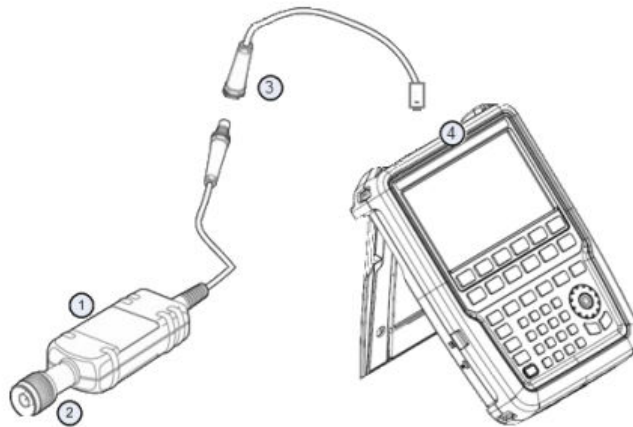

- 1 = Supported power sensor (e.g R&S FSH-Z1, R&S NRP-Z11)  
 2 = Power sensor connector (DUT)  
 3 = USB binder adaptor (R&S FSH-Z101)  
 4 = USB port connector

**Measuring the power**

1. Press [MODE] key.
2. Select "Power Meter" softkey.  
The R&S ZNH switches its operating mode.

If the R&S ZNH recognizes a power sensor, it sets up a connection via the USB interface. After a few seconds, the R&S ZNH shows the measured power.

If no power sensor has been connected or is not connected appropriately, the R&S ZNH shows nothing.

If there are communication problems between the R&S ZNH and the power sensor, the R&S ZNH displays an error message that indicates a possible cause.

For more information on the error messages, see [Table 10-1](#).

### Zeroing the power sensor

To compensate internal offsets of the power meter, a **zeroing** for the power sensor is required before starting the measurement.

1. Select "Zero" softkey.  
Do not to apply any signals to the power sensor while zeroing is active.  
A popup message box is displayed to provide instructions during the zeroing of the power sensor.



#### Please Remove All Signals

From the sensor input and press Continue to start zeroing

2. Disconnect the power sensor from any signal sources.
3. Select "Continue" softkey to start zeroing.  
The R&S ZNH starts the zeroing process.



#### Zeroing Power Sensor

Please wait while the system is zeroing the power sensor

4. Wait for the zeroing process to finish.  
After zeroing, the R&S ZNH displays the message "Power sensor zero done" and again shows the power sensor softkey menu.



#### Power sensor zero done

5. Connect the DUT to the power sensor.  
The R&S ZNH shows the measured power level in dBm. For more information, see [Chapter 10.1, "Using a power sensor"](#), on page 193.

### Set the frequency

To get the best results, enter the frequency of the signal under test.

1. Select "Freq" softkey.  
The R&S ZNH opens an entry box to enter the frequency.
2. Enter the frequency of the signal.
3. Confirm the entry with one of the unit keys.

The R&S ZNH transfers the new frequency to the power sensor which then corrects the measured power readings.

## 4.6.2 Measuring power and return loss

With the directional power sensors R&S FSH-Z14 and R&S FSH-Z44, you can measure the power in both directions.

When you connect the directional power sensor between the source and the load, the R&S ZNH measures the power from the source to load (forward power) and from the load to source (reverse power).

The ratio between the forward and reverse power is a measure of the load matching. The R&S ZNH displays it as the return loss or standing wave ratio.

The power sensors for the R&S ZNH have an asymmetrical design. Therefore, they have to be inserted into the test setup in such a way that the "Forward" arrow on the sensor points toward the load (in the direction of the power flux).

When measuring high powers, pay strict attention to the following instructions to avoid personal injury and to prevent the power sensor from being destroyed.

### **CAUTION**

#### **Danger of skin burns and damage to the instrument**

- Never exceed the permissible continuous power.
- See diagram on the rear of the sensor for the permissible continuous power.
- Turn off the RF power to connect the sensor.
- Screw the RF connectors tightly.

#### **Test setup**

Connect the power sensor cable to the USB port of R&S ZNH. If the power sensor is having the binder connector (i.e R&S FSH-Z14, R&S FSH-Z44), the FSH-Z144 adaptor cable is needed. Insert the directional power sensor between the source and the load.

The power sensors for the R&S ZNH have an asymmetrical design. Hence, you have to insert them into the test setup in such a way that the "Forward" arrow (1→2) on the sensor points toward the load (= in the direction of the power flux).

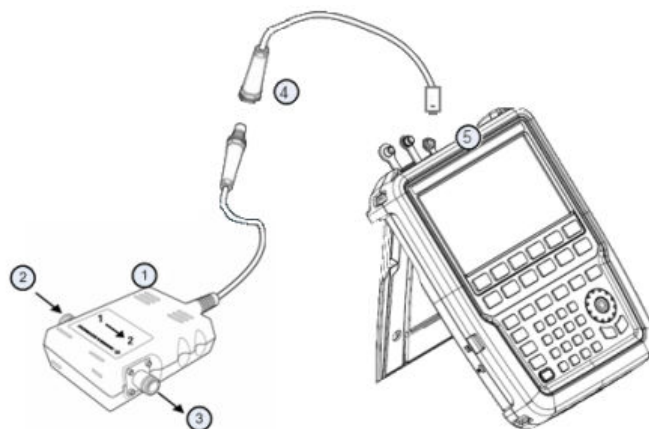

- 1 = Directional power sensor R&S FSH-Z14 or Z44
- 2 = Source
- 3 = Load
- 4 = USB binder adaptor (R&S FSH-Z144)
- 5 = USB port connector

### Measuring the power

1. Press [MODE] key.
2. Select "Power Meter" softkey.

As soon as the R&S ZNH recognizes the power sensor, it displays the type of the directional power sensor that is connected in the [title bar](#). After a few seconds, it also shows the forward power and return loss currently measured at the load.

### Zeroing the power sensor

Before performing the power measurement, you should zeroing the power sensor.

After zeroing is done, the R&S ZNH displays the message "Power sensor zero done" and again shows the power sensor softkey menu.

- ▶ Connect the R&S FSH-Z14 or R&S FSH-Z44 between the source and the load. The R&S ZNH displays the measured forward power in dBm and the SWR of the load. See [Figure 10-2](#).

To get the best results, you should also define the frequency of the signal. For more information, see [Chapter 10.2, "Using a directional power sensor"](#), on page 198.

## 4.7 Saving and recalling results and settings



### Storage device

If both USB flash drive and micro-SD card are connected to the instrument, the USB flash drive takes precedent over SD card as a storage device.

If both storage devices are not connected, the internal memory of the instrument is used for storage.

The R&S ZNH can store measurement results and settings in the internal memory, removable micro-SD card or on a USB flash drive via the USB interface.

Results and settings are always stored together, allowing them to be interpreted in context when recalled. The R&S ZNH can store at least 100 data records in the internal memory which are differentiated by their names.

The R&S ZNH provides two [USB ports](#) and one [micro-SD card slot](#).

For more information on saving measurement results and settings, see [Chapter 5.8.1, "Saving datasets"](#), on page 89.

For more information on recalling measurement results and settings, see [Chapter 5.8.2, "Restoring datasets"](#), on page 91.

## 5 Instrument functions

The following chapters provide information about the basic functionality and the user interface of the R&S ZNH.

• <a href="#">Touchscreen gesture element</a> .....	72
• <a href="#">On-screen keyboard</a> .....	77
• <a href="#">Front panel keys</a> .....	78
• <a href="#">Presetting the R&amp;S ZNH</a> .....	83
• <a href="#">Configuring measurements</a> .....	84
• <a href="#">Working directory</a> .....	84
• <a href="#">Taking screenshots</a> .....	85
• <a href="#">Managing datasets</a> .....	87
• <a href="#">Updating the firmware</a> .....	94
• <a href="#">Installing firmware options</a> .....	94
• <a href="#">Device documentation</a> .....	94

### 5.1 Touchscreen gesture element

To enhance greater flexibility and user experience in the user interaction with R&S ZNH, special touchscreen gestures are introduced. The following illustrated the list of special gestures that R&S ZNH provides.

• <a href="#">Change center frequency</a> .....	72
• <a href="#">Change reference level</a> .....	73
• <a href="#">Change span</a> .....	73
• <a href="#">Add marker</a> .....	74
• <a href="#">Move marker</a> .....	74
• <a href="#">Delete all markers</a> .....	75
• <a href="#">Hide or unhide measurement result view display</a> .....	75
• <a href="#">Preview screenshot</a> .....	76
• <a href="#">Skip wizard measurement</a> .....	76

#### 5.1.1 Change center frequency

Swipe left or right horizontally in the trace window to adjust the center frequency of the spectrum measurement. Alternatively, select the "Center" softkey in the [Parameter view](#) to adjust the center frequency or press the [FREQ/DIST] key on the front panel to display the "Center Freq" softkey label for adjustment.



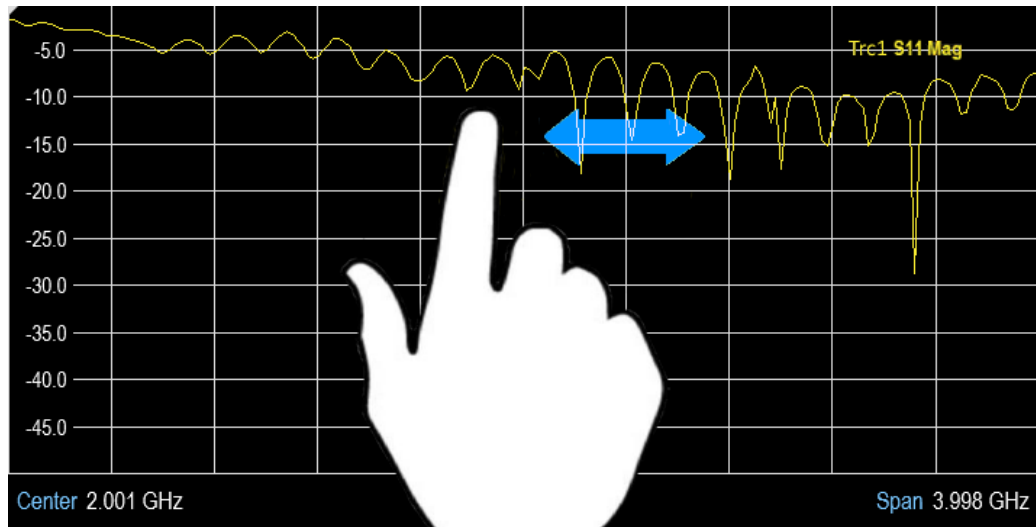

### 5.1.2 Change reference level

Swipe up or down vertically in the trace window to adjust the reference level of the spectrum measurement. Alternatively, select the "REF" softkey in the [Parameter view](#) to adjust the reference level or press the [SCALE] / [SCALE/AMPT] key on the front panel to display the "Ref Level" softkey label for adjustment.

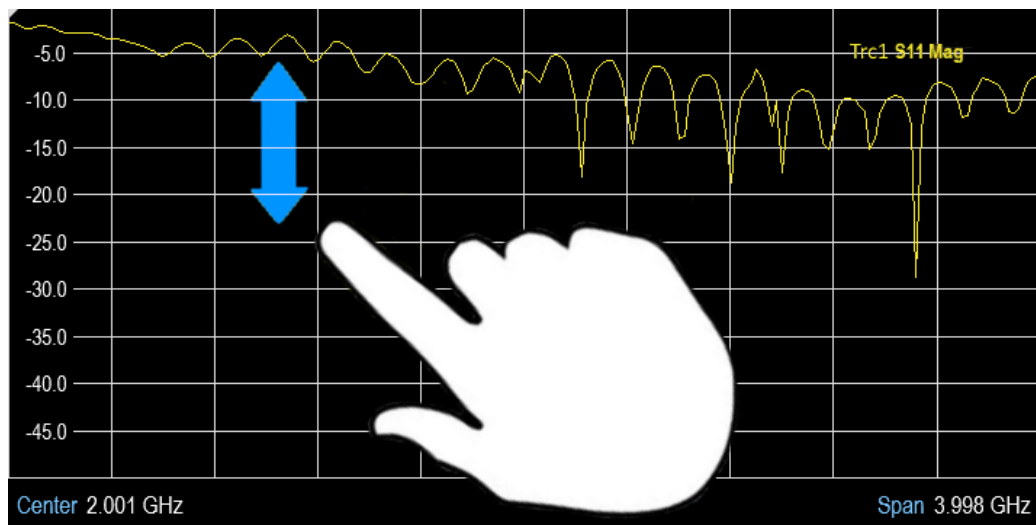

### 5.1.3 Change span

Pinch or stretch two fingers horizontally to adjust the span of the spectrum measurement. Alternatively, select the "Span" softkey in the [Parameter view](#) to adjust the span of the spectrum measurement or press the [FREQ/DIST] key on the front panel and select the "Span" softkey label for adjustment.

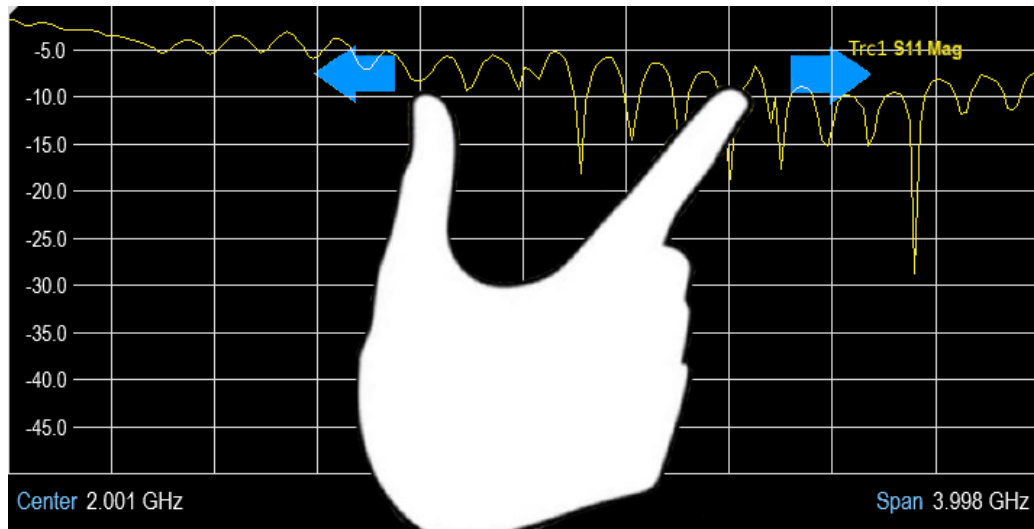

### 5.1.4 Add marker

Double tap in the trace window to create a marker on the spectrum measurement. The marker is placed on the trace where the double tap gesture is performed.

Alternatively, press the [MARKER] key on the front panel and select the "New Marker" softkey to create a marker on the spectrum measurement.

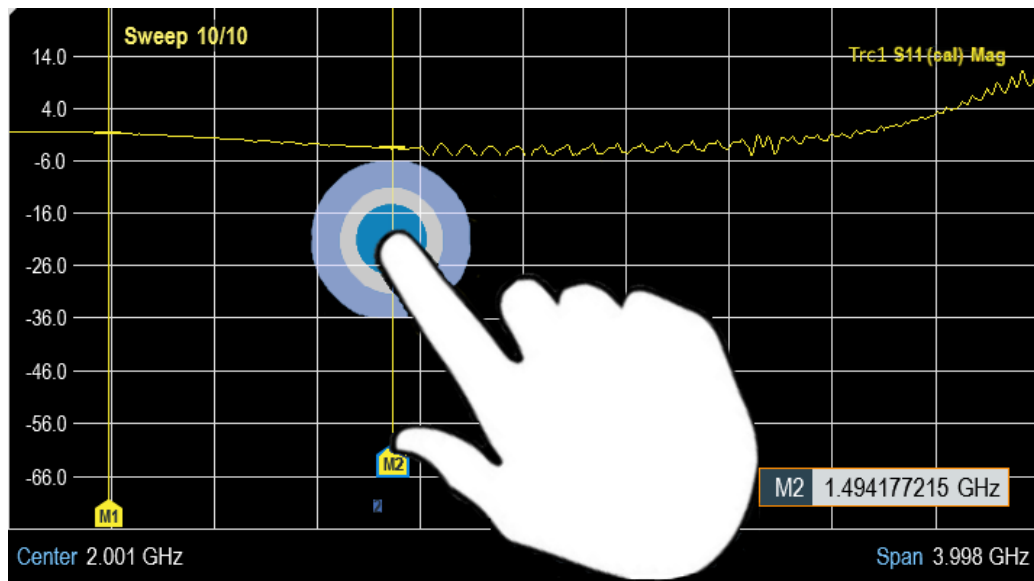

### 5.1.5 Move marker

Tap and drag on the marker icon to change the marker position in the trace window.

Alternatively, select the marker label in the [Measurement result view](#) to adjust the marker position on the spectrum measurement or press the [MARKER] key on the front panel and select the "Select Marker" softkey for adjustment.

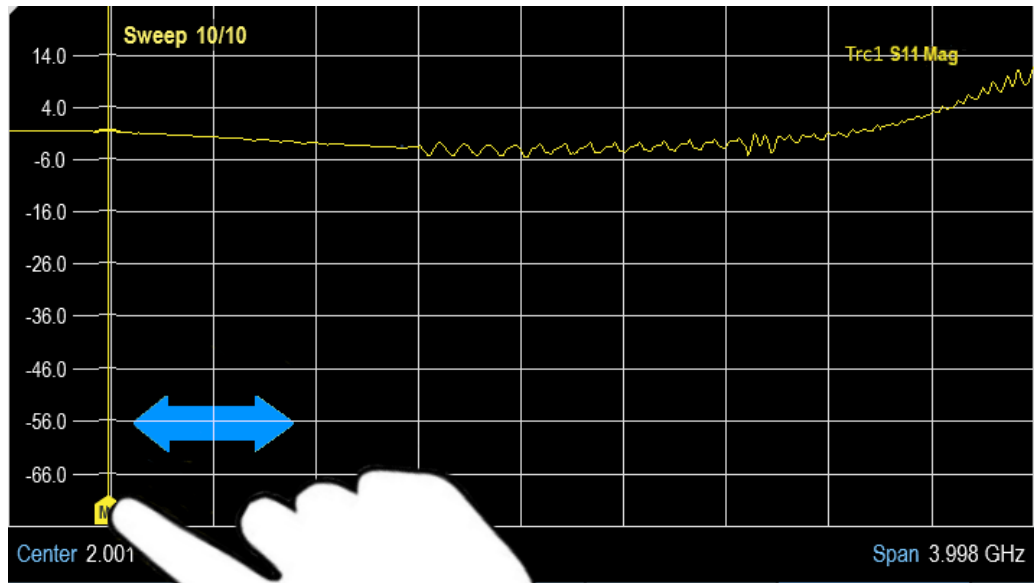

### 5.1.6 Delete all markers

Draw an "X" on the trace window to delete all markers from the spectrum measurement. Alternatively, press the [MARKER] key on the front panel and select the "Delete Marker" softkey to delete all markers from the spectrum measurement.

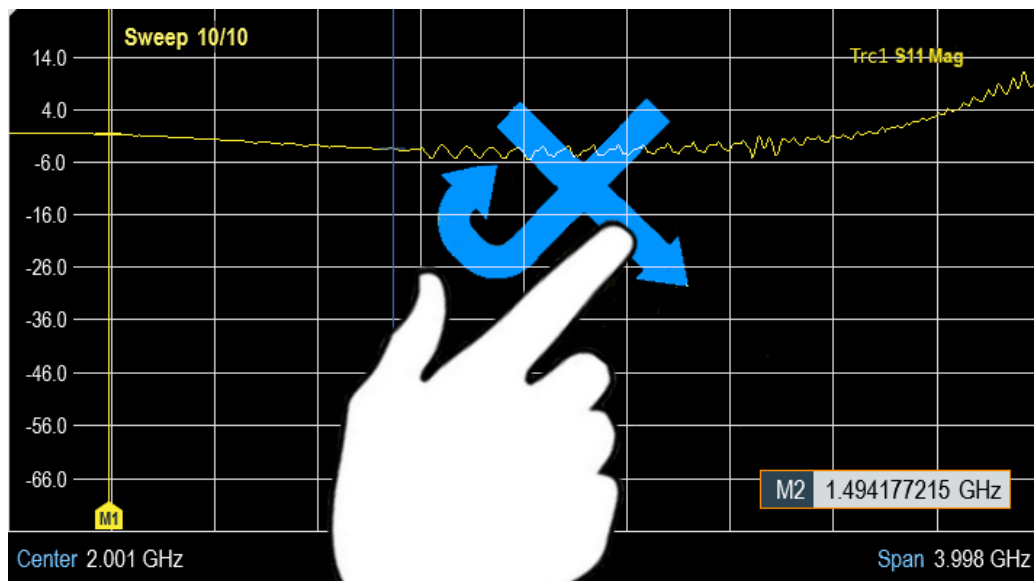

### 5.1.7 Hide or unhide measurement result view display

Swipe up or down vertically on the [Measurement Result View](#) window to hide or view the results display window.

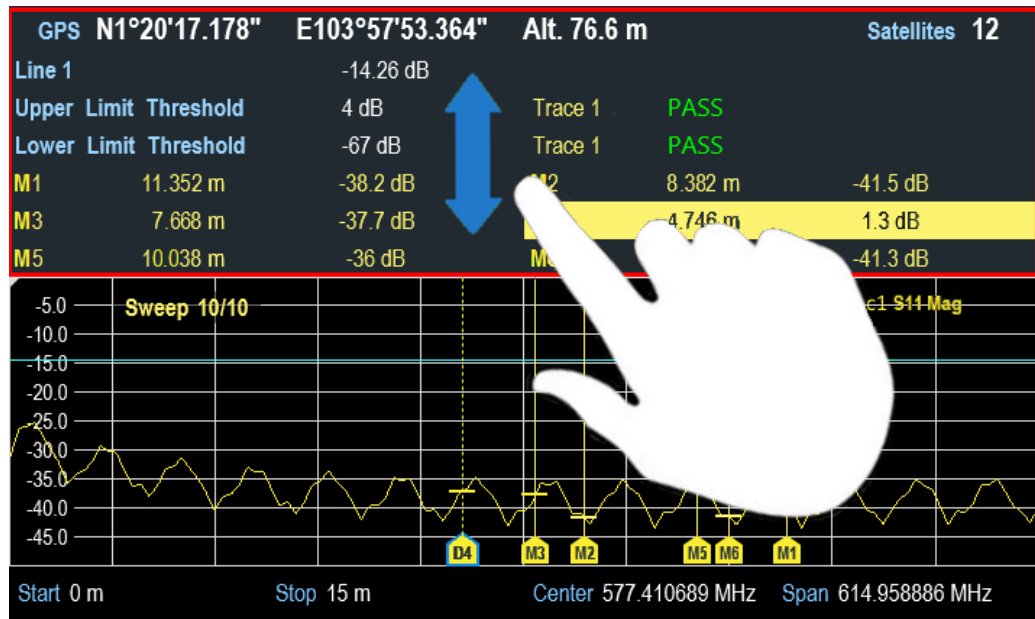

### 5.1.8 Preview screenshot

Swipe horizontally to the left or right direction in the trace window to preview the screenshot. Alternatively, select the "Prev" or "Next" softkey to preview the screenshot.

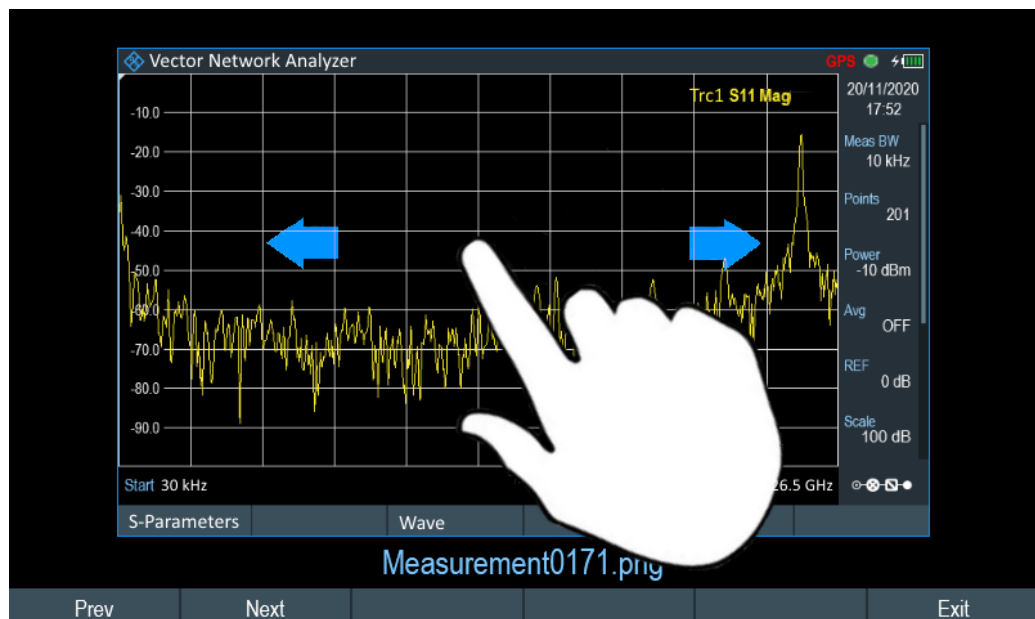

### 5.1.9 Skip wizard measurement

Swipe horizontally to the left direction to skip a wizard measurement. Alternatively, select the "Skip" softkey to skip the measurement.

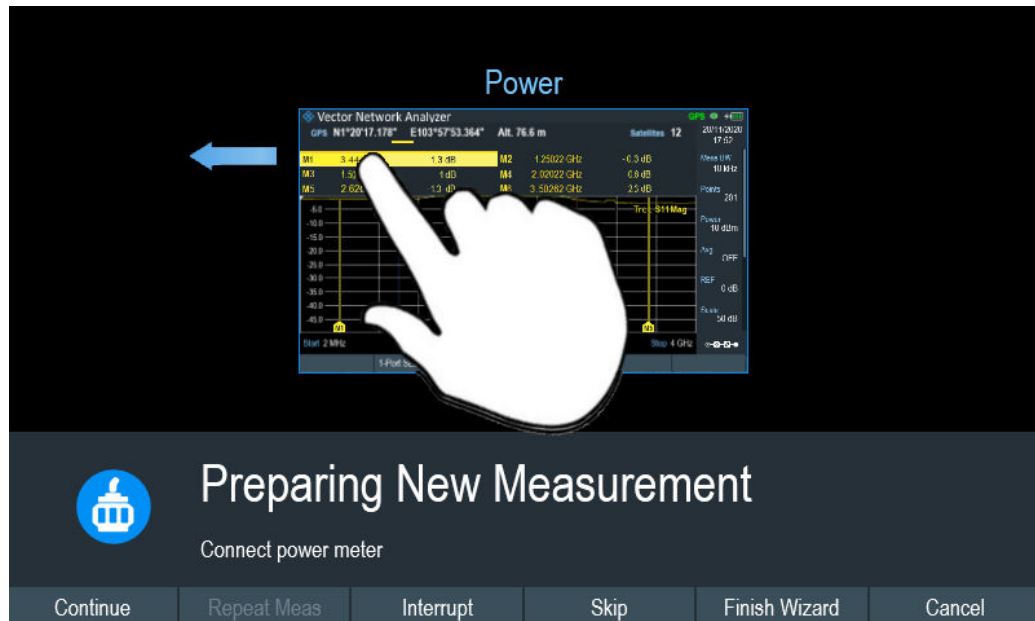

## 5.2 On-screen keyboard

The on-screen keyboard is an additional means of interacting with the instrument. It provides convenience of usage with the touchscreen input.

Accessing the on-screen keyboard is only available for text-based entry, e.g. save or open a filename.



### Touchscreen interface

If the [touchscreen interface](#) is not activated, the on-screen keyboard is disabled.



The on-screen keyboard display can be switched on and off using the on-screen keyboard  icon highlighted at the top right-hand corner.

## 5.3 Front panel keys

The following chapters illustrate the function of the front panel keys.

### 5.3.1 POWER key

The [POWER]  key is located on the lower left of the front panel. It starts up and shuts down the instrument.

See [Chapter 3.1.2, "Switching the instrument on and off"](#), on page 23.

See also [Figure 3-4](#).

### 5.3.2 Screenshot key

The screenshot  key provides a quick way to capture screenshot of the current screen at anytime.

For more information, see [Chapter 5.7, "Taking screenshots"](#), on page 85.

### 5.3.3 Softkey

The six softkeys on the front panel are used to access the softkey label. See [Figure 3-4](#).



The softkey label is function-specific depending on the key selected on the front panel of the instrument. See [Chapter 5.3.5, "Function keys"](#), on page 79.

### 5.3.4 System keys

System keys provide settings affecting the general instrument settings, result evaluation settings and save and recall functions.



SYSTEM keys	Descriptions
[PRESET]	Resets the instrument to the default state.
[SETUP]	Provides basic instrument configuration functions: <ul style="list-style-type: none"> <li>• Date, time, display, audio and regional configuration</li> <li>• Battery low indicator</li> <li>• LAN interface</li> <li>• Disabling and enabling of options</li> <li>• Information about instrument configuration including firm-ware version and system error messages</li> </ul>
[MODE]	Provides the selection between applications. <ul style="list-style-type: none"> <li>• "Vector Network Analyzer"</li> <li>• "Cable &amp; Antenna"</li> <li>• "Vector Voltmeter"</li> <li>• "Power Meter"</li> </ul>
[LINES]	Configures display line and limit lines.
[SAVE RECALL]	Provides a file manager function to facilitate the saving and recalling of result and instrument settings.

### 5.3.5 Function keys

Function keys provide access to the most common measurement settings and functions in the instrument.



FUNCTION keys	Descriptions
[FREQ/DIST]	Mode-dependent button. Sets the center frequency, frequency span, start and stop frequencies for the frequency range under consideration. It also sets the time and distance settings in time domain measurement.
[CAL]	The [CAL] key provides the following functions: <ul style="list-style-type: none"> <li>• Performs calibration on the R&amp;S ZNH.</li> <li>• Selection of calibration kit models, calibration ports and calibration methods for measurement.</li> <li>• Sets calibration port length offset to shift the calibration plane.</li> </ul> For more information, see <a href="#">Chapter 8.1, "Calibrating measurements"</a> , on page 154.

FUNCTION keys	Descriptions
[SCALE/AMPT]	<p>Mode-dependent button.</p> <p>The [SCALE/AMPT] key provides the following functions:</p> <ul style="list-style-type: none"> <li>• Sets the reference level, dynamic range of the reference level and auto scaling of the reference level.</li> <li>• Sets tracking generator power and receiver attenuation.</li> </ul> <p>For more information, see <a href="#">Chapter 8.4.2, "Configuring the vertical axis"</a>, on page 179 for VNA mode and <a href="#">Chapter 7.2.3, "Configuring the vertical axis"</a>, on page 136 for CAT mode.</p>
[WIZARD]	<p>Performs a sequence of standardized and recurring measurements.</p> <p>See <a href="#">Chapter 6, "Working with the measurement wizard"</a>, on page 96.</p>
[FORMAT]	<p>Mode-dependent button.</p> <p>This key provides functionality to select and configure measurements in the following</p> <ul style="list-style-type: none"> <li>• In VNA measurement mode: Provides the different measurement format for trace measurement: "dB Mag", "Linear", "Phase", "Smith", "SWR", "Polar", "Group Delay". See <a href="#">Chapter 8.4.3, "Selecting the measurement format"</a>, on page 181.</li> <li>• In CAT measurement mode: Depending on the measurement modes, provides the different measurement formats in the following: <ul style="list-style-type: none"> <li>– Return Loss: "db Mag", "Phase Wrap", "Phase Unwrap", "Smith" and "SWR"</li> <li>– DTF: "db Mag", "SWR"</li> <li>– Transmission: "db Mag", "Phase Wrap" and "Phase Unwrap"</li> <li>– Cable Loss: "db Mag"</li> <li>– RL + Trans: "db Mag", "Phase Wrap" and "Phase Unwrap"</li> </ul> </li> </ul> <p>See <a href="#">Chapter 7.1, "Performing cable and antenna measurements"</a>, on page 109.</p>
[SWEEP]	<p>Sets number of sweep points for measurement. Up to a maximum of 16000 sweep points is configurable</p> <p>Selects continuous measurement or single measurement.</p> <p>In VNA mode, the [SWEEP] key also provides the functionality to set the sweep time, resolution bandwidth as well as trigger mode and trigger delay of the external trigger signal.</p>
[TRACE]	<p>Configures the measured data acquisition and the analysis of the measurement data.</p> <p>Sets the suppress interference signal and aperture mode for measurement.</p> <p>In VNA mode, selects the display combinations of <a href="#">measurement trace windows</a> ("Single", "Dual-Hor", "Dual-Vert", "Triple", "Quad").</p>



FUNCTION keys	Descriptions
[MEAS]	<p>Mode-dependent button.</p> <p>This key provides functionality to select and configure measurements in the available measurement modes.</p> <p>For more information, see the corresponding measurement modes in the R&amp;S ZNH user manual.</p>
[MARKER]	<p>Mode-dependent button.</p> <p>Sets and positions the absolute and relative measurement markers (markers and delta markers).</p> <p>Marker positioning using peak, next peak and minimum level.</p> <p>Marker search limit function.</p> <p>Enables or disables checkbox for "View List" function.</p> <p>Provides the following marker functions:</p> <p>In VNA measurement mode</p> <ul style="list-style-type: none"> <li>• Marker mode function provides marker format of the selected trace. Available format: "dB Mag + Phase", "Lin Mag + Phase (Rho)", "Real + Imag (Rho)", "R +jX", "G +jB", "(R+ jX) / Z0", "(G + jB) / Y0"</li> <li>• Sets reference impedance</li> </ul> <p>For more information, see <a href="#">Chapter 8.5.2, "Using markers"</a>, on page 187.</p>

### 5.3.6 Keypad

The keypad is used to enter alphanumeric parameters, including the corresponding units.

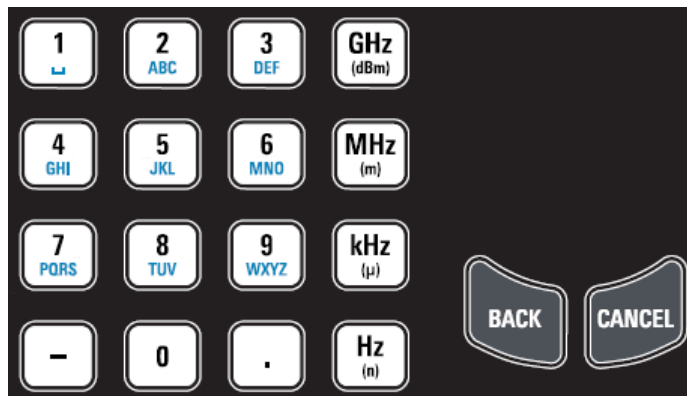

It contains the following keys:

Type of key	Description
Alphanumeric keys	Enter numbers and (special) characters in edit dialog boxes.
Decimal point	Inserts a decimal point "." at the cursor position.
Sign key	Changes the sign of a numeric parameter. In the case of an alphanumeric parameter, inserts a "-" at the cursor position.

Type of key	Description
Unit keys (GHz/-dBm MHz/ dBm, kHz/dB and Hz/dB)	These keys add the selected unit to the entered numeric value and complete the entry. In the case of level entries (e.g. in dB) or dimensionless values, all units have the value "1" as multiplying factor. Thus, they also act like an enter key function.
CANCEL key	Closes all kinds of dialog boxes, if the edit mode is not active. Quits the edit mode, if the edit mode is active. In dialog boxes that contain a "Cancel" button, it activates that button.  For "Edit" dialog boxes the following mechanism is used: <ul style="list-style-type: none"> <li>• If data entry has been started, it retains the original value and closes the dialog box.</li> <li>• If data entry has not been started or has been completed, it closes the dialog box.</li> </ul>
BACK key	If an alphanumeric entry has already been started, this key deletes the character to the left of the cursor.  Note: If an entry is confirmed with enter key, this key restores the value entered before. This action can be used to toggle, for example, between two frequencies.

### 5.3.7 Navigation controls

The rotary knob provides navigation controls in the display or within dialog boxes.



The rotary knob has several functions:

- Increments (clockwise direction) or decrements (counter-clockwise direction) the instrument parameters at a defined step width in the case of a numeric entry
- Shifts markers, limit lines and display line on the screen
- Acts like a cursor key in dialog boxes or softkey submenus.
- Moves the scroll bar vertically if the scroll bar is in focused
- Acts as an enter key when pressed

## 5.4 Presetting the R&S ZNH



Before you prepare a measurement, it is recommended to preset the R&S ZNH. During a preset, the R&S ZNH resets all settings to their default state. Restoring the default configuration has the advantage that old settings do not affect measurements.

The default setup is specific to the operating mode.

- ▶ Press [PRESET] key.  
The R&S ZNH restores its default setup.

You can load or discard a previous calibration data during a preset.

You can also define your own default settings via a dataset. This dataset is then loaded after pressing the [PRESET] key instead of the factory default.

1. Press [SETUP] key.
2. Select "User Preference" softkey.
3. In the "User Preferences" dialog box, select the "Preset Dataset" item.  
The R&S ZNH displays the file manager dialog box to select the dataset that contains the settings you would like to have as the preset settings.

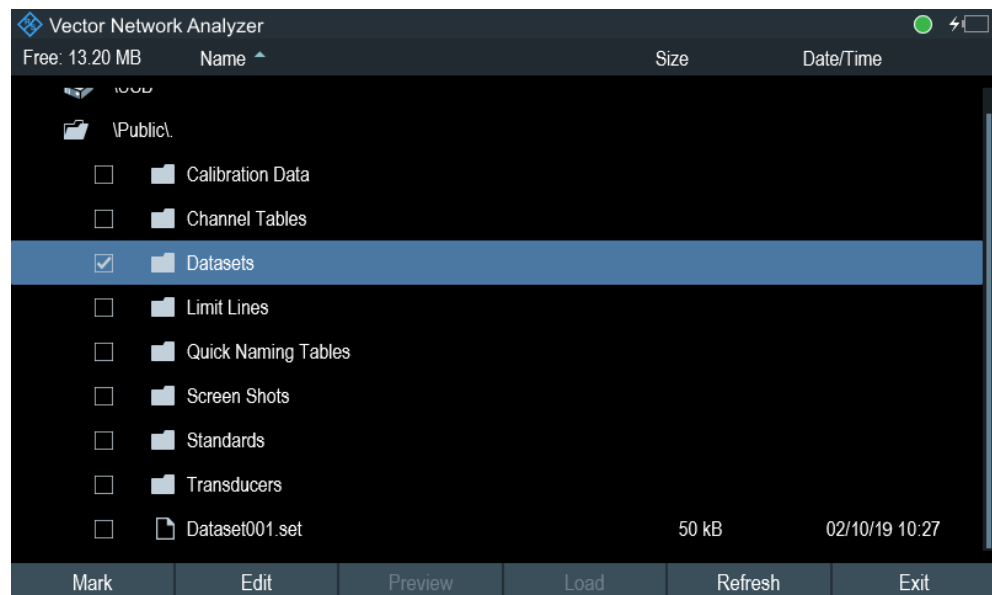

4. Select the dataset with the settings you want and press "Load" softkey.
5. In the "User Preferences" dialog box, select the "Preset Mode" item.  
A drop-down menu opens to select the preset mode.
6. Select "User Defined" to load the dataset defined in the "Preset Dataset".  
The R&S ZNH now loads the settings of the dataset after you press [PRESET.]
7. Select "Discard Calibration Data" to define the usage of user calibration data after preset.

A drop-down menu opens to select the user calibration data.

8. Select "On" to apply user calibration data or "Off" to discard calibration data after preset.  
Depending on the selection, the R&S ZNH loads or discards the calibration data after preset.

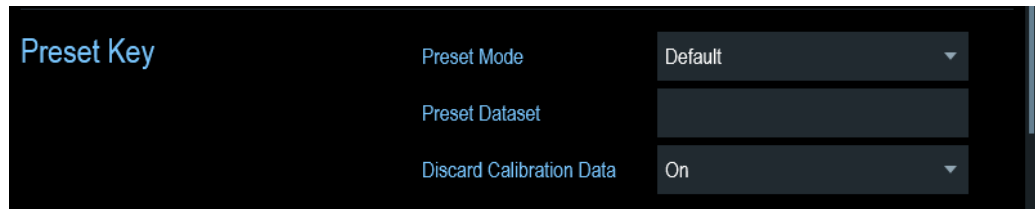

## 5.5 Configuring measurements



The [Configuration overview](#) dialog box provides an overview of the current configuration of the R&S ZNH. In addition, you can also change the configuration in this dialog box.

1. Press [SETUP] key.
2. Select "Config Overview" softkey.
3. Select one of the dialog boxes and change the settings as you like.

Note that the contents of the "Config Overview" dialog box are customized for each operating mode of the R&S ZNH. Therefore, the order and number of displayed settings are different in each mode.

## 5.6 Working directory

Using the "Working Directory", you can customize the folder directory to save the screenshots and datasets captured during measurement.

1. Press [SETUP] key.
2. Select "User Preference" softkey.
3. In the "User Preferences" dialog box, select the "Using working directory" item.
4. Select "On" to activate the customize folder directory or "Off" to use the default storage device in the R&S ZNH. See ["Data storage devices"](#) on page 89.
5. Define the folder name in the "Working directory" item.

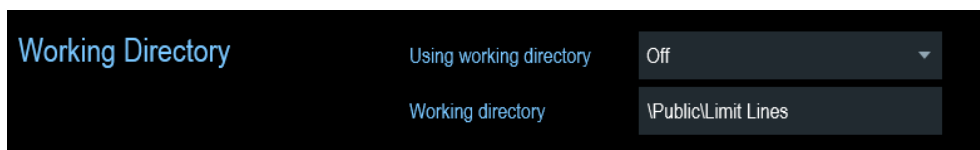

## 5.7 Taking screenshots



You can take and store a screenshot of the current screen anytime with the screenshot key.

- ▶ Press the screenshot key.  
The R&S ZNH takes the screenshot.

If available, the R&S ZNH stores the screenshot on an external storage device (USB flash drive or micro-SD card). If both are connected, the R&S ZNH uses the USB flash drive.

If no external device is available, the R&S ZNH stores the screenshot in its internal memory until the internal memory is full. In that case, you can transfer the screenshots with the R&S InstrumentView software to your computer.



### Saving screenshot and dataset at the same time

Depending on the "Capture" settings configured in the "User Preference" menu, using the screenshot key also saves a dataset in addition to the screenshot.

For more information, see [Chapter 5.8, "Managing datasets"](#), on page 87.

### Screenshot filename and file format

All screenshots get a default filename "Screenshot#####". The files also get numbers (#####) in an ascending order, beginning with 0000. You can select a default filename and a starting number in the "User Preference" menu.

The file format of screenshots is either \*.png or \*.jpg, depending on your configuration in the "User Preference" menu.

1. Press [SETUP] key.
2. Select "User Preference" softkey.
3. Select the "Default Filename" and "Filename Counter Starts At" items and assign a filename and number as you wish.
4. Select the "Capture Screen Format" items to select the screenshot file format.

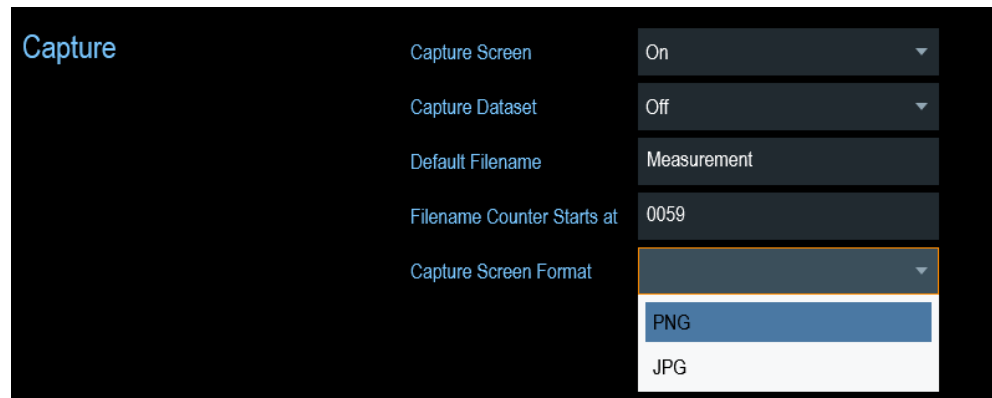

### Previewing screenshots

The R&S ZNH provides functionality to preview screenshot.



#### Special touchscreen gesture

You can swipe horizontally to the left or right direction to preview the screenshot. See [Chapter 5.1.8, "Preview screenshot"](#), on page 76.

1. Press [SAVE/RECALL] key.
2. Select "File Manager" softkey.  
The R&S ZNH opens the file manager to select a screenshot for the preview.
3. Select the screenshot for preview.
4. Select "Preview" softkey to preview the screenshot.
5. Select the "Prev" or "Next" softkey to preview the screenshots available in the selected folder.  
The filename of the previewed screenshot is displayed below the screenshot. See [Figure 5-1](#) and [Figure 5-3](#).
6. Select "Exit" softkey to return to the file manager.

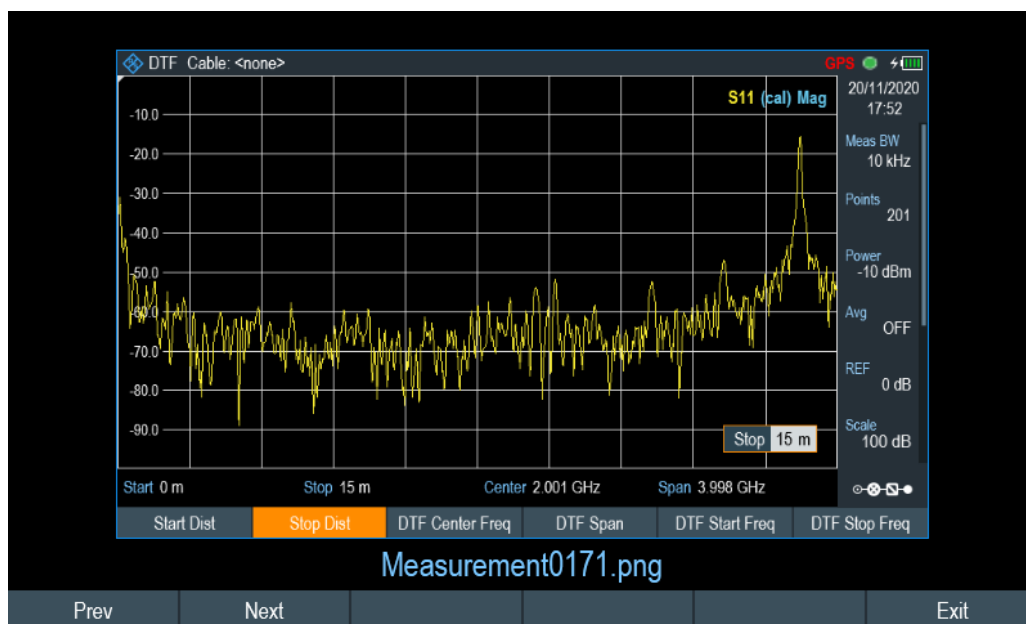

Figure 5-1: Preview screenshot

## 5.8 Managing datasets



The R&S ZNH provides functionality to manage (e.g. save, restore, delete) datasets available in its internal memory or an external storage device.

### Datasets

The R&S ZNH supports various types of datasets. The instructions below primarily describe the management of datasets that you create on the R&S ZNH during measurements, for example measurement results and configurations. Note that these datasets have the file extension `.set`.

Datasets with the file extension `.set` are an image of measurement results and configurations. Thus, you can subsequently reproduce the context of the measurement.

Using the R&S InstrumentView software, you can use the datasets for documentation purposes or post-processed it for a more detailed analysis later on. Note that datasets also contain calibration data if calibration has been performed.

### Templates



The R&S ZNH also supports various other types of datasets or templates. Such templates mainly contain additional requirements for a particular measurement, like limit lines or channel tables.

Creating and editing of these templates are only possible with the functionality provided by the R&S InstrumentView software package. Note that the file extension depends on the application of the template (for example, a template containing a channel table has the extension `.chntab`).

For more information on working with templates and datasets, refer to the documentation of the R&S InstrumentView software package.

### Data synchronization

The R&S InstrumentView features data synchronization that matches the data available between the R&S ZNH and the PC.

1. Select "File Transfer" from the "Instrument" menu.  
The software opens the "File Transfer" dialog box.
2. Select the "Template & Result"  synchronization button to process data synchronization between the computer and instrument.  
This data synchronization updates all files that have been created or edited with the R&S InstrumentView software package to the instrument and vice versa. (Note that template can only be created and edited in the PC, see "[Templates](#)" on page 87).
3. Alternatively, data can be transferred in a single direction using the  direction button between the PC and instrument and vice versa.

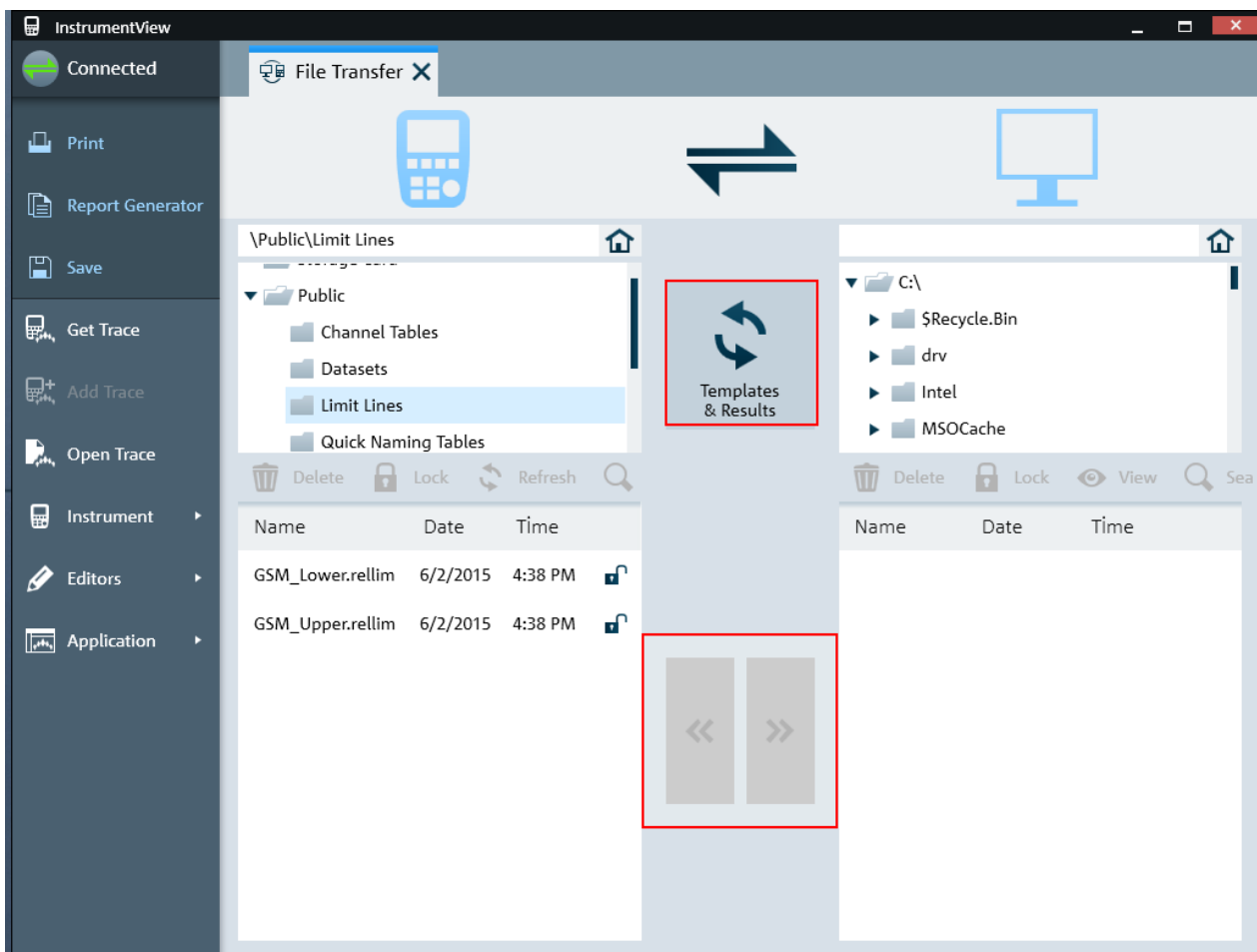



• Saving datasets.....	89
• Restoring datasets.....	91
• Deleting datasets.....	93
• Export datasets.....	94

### 5.8.1 Saving datasets

The R&S ZNH allows you to save the data that is analyzed at any time.

1. Press [SAVE/RECALL] key.

2. Select "Save" softkey.

The R&S ZNH opens the "Save Dataset" dialog box.

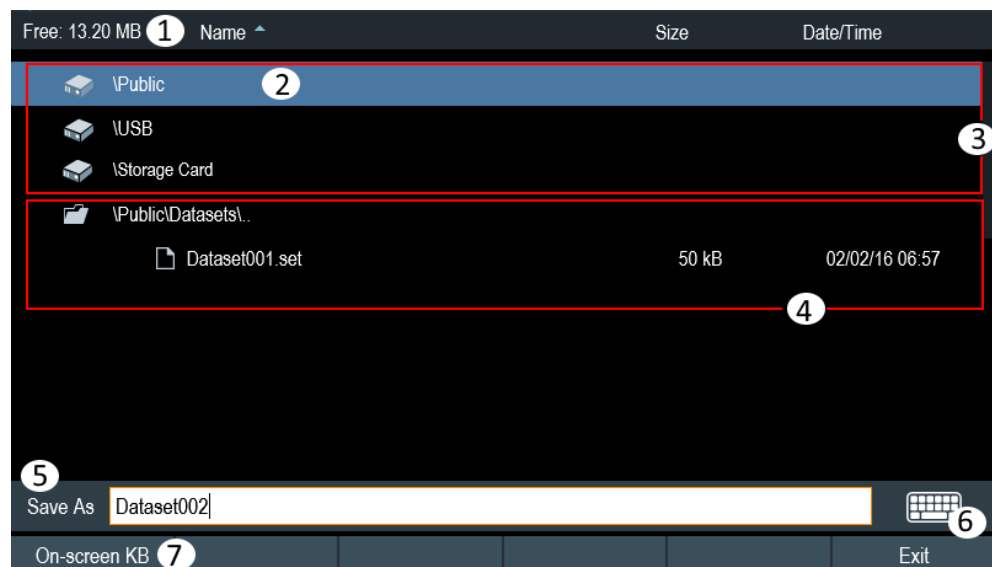

**Figure 5-2: Save Dataset dialog box**

- 1 = Remaining memory on selected data storage device
- 2 = Currently selected data storage
- 3 = Available data storage
- 4 = Currently folder structure of the selected data storage
- 5 = Dataset name input field
- 6 = [On-screen keyboard](#) icon
- 7 = File manager softkey menu

#### Data storage devices



##### Storage device

If both USB flash drive and micro-SD card are connected to the instrument, the USB flash drive takes precedent over SD card as a storage device.

If both storage devices are not connected, the internal memory of the instrument is used for storage.

The folder structure shows all the available data storage devices. Possible storage devices are the internal memory of the R&S ZNH, micro-SD card or USB flash drive.

The default storage device depends on which devices are connected to the R&S ZNH. See "[Storage device](#)" on page 89.

The internal memory provides approximately 20 MB of data, therefore the number of datasets you save on the R&S ZNH is limited. Each dataset needs about 100 kB of memory, but this value can vary.

If you are using an external storage device, the number of datasets you can save is limited only by the size of the storage device.

R&S ZNH shows the remaining memory on the storage device in the dialog box.

1. Select the storage device you want to save the data.
2. Select the folder you want to save the data.
3. Enter a filename in the corresponding input field.  
The default filename for datasets is `Dataset###.set` with a new number in ascending order for each new dataset. The file extension for datasets is `.set`. If you enter another name, the R&S ZNH uses that name and assigns a new number to the filename if you save the data set the next time. This function allows you to assign consecutive dataset filename without entering a new name every time you want to save a dataset.  
You can define the dataset filename at the "User Preference" dialog box. Select the "Default Dataset Name" and enter the filename in the entry box.
4. Press the rotary knob to confirm the entry.  
The R&S ZNH saves the dataset.

#### 5.8.1.1 Alternative ways to save datasets

Using the screenshot key , the R&S ZNH provides an alternative and more convenient way to save dataset.

1. Press [SETUP] key.
2. Select "User Preference" softkey.
3. Configure the "Default Filename", "Filename Counter Starts at" and "Capture Screen Format" menu items.  
The screenshot key  saves a screenshot of the display and the selected data of the current measurement based on the filename syntax defined in the "Default Filename", "Filename Counter Starts at" and "Capture Screen Format" menu items.

#### 5.8.1.2 Renaming filename

If necessary, you can rename files or file directories directly on the R&S ZNH.

1. Press [SAVE/RECALL] key.
2. Select "File Manager" softkey.  
The R&S ZNH opens the file manager.
3. Select the files or file directories in the file manager.  
Alternatively, press the "Mark" softkey to select the desired files or files directories.
4. Select "Edit" softkey.  
The R&S ZNH displays a submenu for selection.
5. Select "Rename" menu item to rename the files or file directories.  
The R&S ZNH opens an input field to change the name of the selected files or file directories.

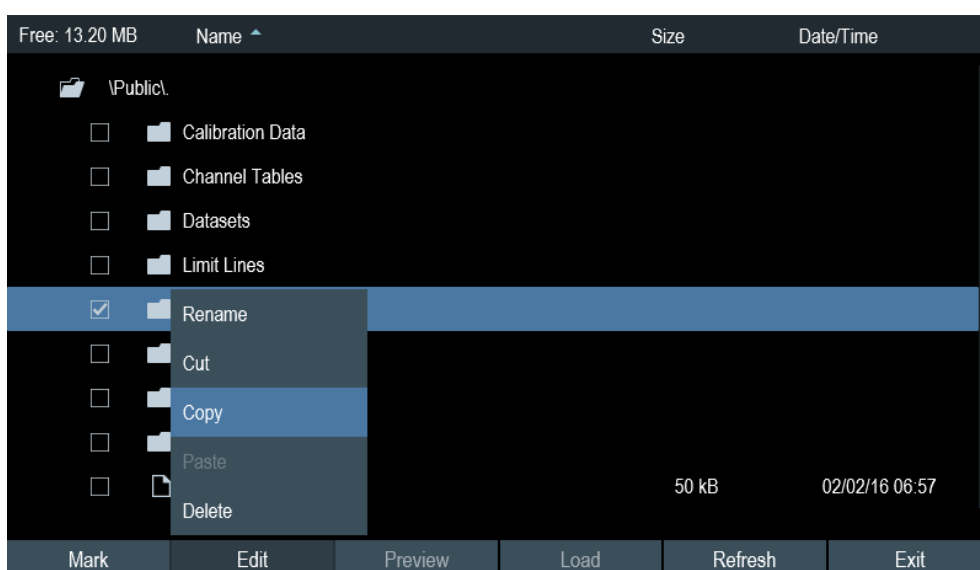

### 5.8.2 Restoring datasets

You can preview and load previous saved measurement results with the recall function of the R&S ZNH. This function also provides easy access to previous measurement settings so that you do not have to set up the R&S ZNH again.

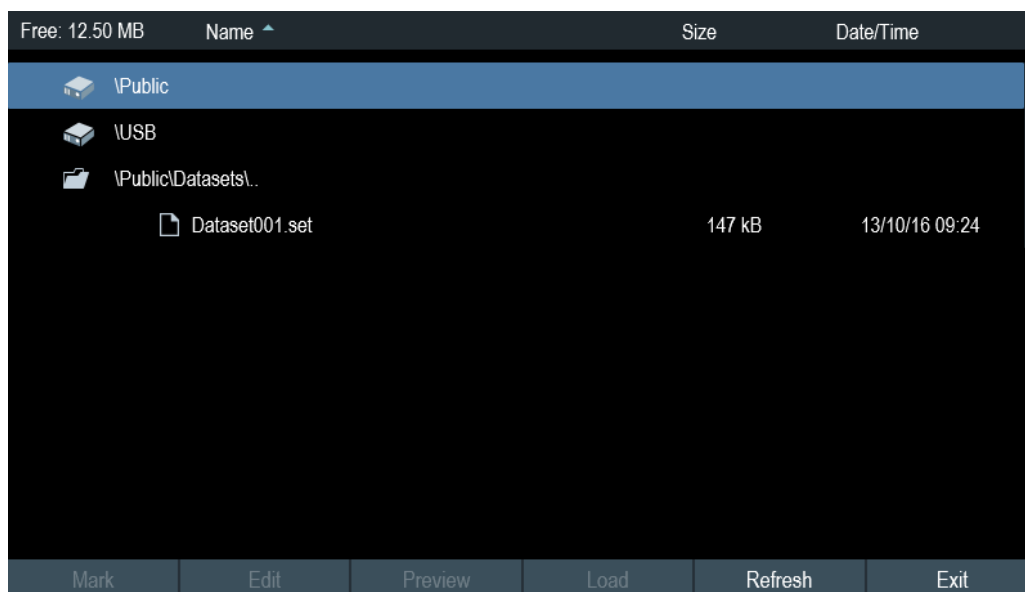

1. Press [SAVE/RECALL] key.
2. Select "Recall" softkey.  
The R&S ZNH opens the "Recall Dataset" dialog box.
3. Select the storage device and file directory you want to load the dataset.  
The R&S ZNH restores the configuration that the dataset contains.

By default, the most recently saved dataset is highlighted. If you need another dataset, navigate to the file directory or storage device that contains the dataset you need.

#### 5.8.2.1 Previewing a dataset

The R&S ZNH provides the function to preview datasets. The preview function allows you to take a quick look at the screenshot and its corresponding measurement settings. During preview, the R&S ZNH does not yet activate the measurement settings of that dataset.

1. Press [SAVE/RECALL] key.
2. Select "File Manager" softkey.
3. Browse through the available datasets and select the desired dataset.
4. Select "Preview" softkey.  
The R&S ZNH shows a preview of the measurement results and the measurement settings contained in the selected dataset.
5. Select the "Prev" or "Next" softkey to preview the datasets available in the selected folder.  
The filename of the previewed dataset is displayed at the bottom of the screen layout. See [Figure 5-3](#).

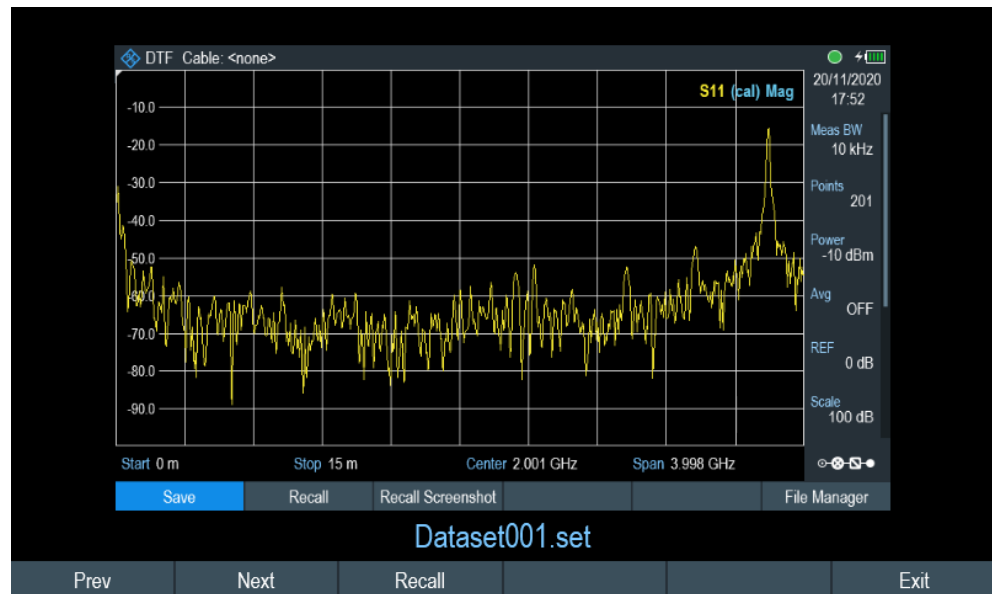

Figure 5-3: Preview dataset

6. Select "Recall" softkey to load the dataset  
Alternatively, select the "Exit" softkey to return to the file manager.

### 5.8.2.2 Loading a dataset

If you find a dataset whose settings you need for your current measurement task, you can load it.

- ▶ Select "Load" softkey.  
The R&S ZNH loads the dataset and adjusts its measurement settings according to the dataset.  
See also [Chapter 5.8.2.1, "Previewing a dataset"](#), on page 92.

### 5.8.3 Deleting datasets

If you have to delete a dataset, you can do so with the file manager.

1. Press [SAVE/RECALL] key.
2. Select "File Manager" softkey.  
The R&S ZNH opens the file manager.
3. Select the desired files or file directories in the file manager.  
Alternatively, press the "Mark" softkey to select the desired files or files directories.
4. Select "Edit" softkey.  
The R&S ZNH displays a submenu for selection.
5. Select the "Delete" menu item to delete the files or file directories.

Before deleting, the R&S ZNH shows a warning message that you need to confirm.

6. Select "Yes" to delete the selected files or file directories.  
The R&S ZNH deletes the selected files or file directories from its memory.

#### 5.8.4 Export datasets

You can export a dataset to CSV format.

1. Press [SAVE/RECALL] key.
2. Select "Export" > "Export CSV" softkey to save dataset as CSV format. For exporting of file in Touchtone format 1.1, see [Chapter 7.1.1.1, "Managing S-Parameters file"](#), on page 112.  
The R&S ZNH opens the "Export Data" dialog box.
3. Select the desired file storage location to save the dataset in CSV format.  
See also [Chapter 5.8.1, "Saving datasets"](#), on page 89.

### 5.9 Updating the firmware

You can download new firmware versions from the R&S ZNH website.

<http://www.rohde-schwarz.com/product/znh.html>

The website also provides release notes for each new firmware version. The release notes include instructions on how to perform a firmware update.

### 5.10 Installing firmware options

You can equip the R&S ZNH with several firmware options to enable additional operating modes or special measurements.

For more information, see [Chapter 4.4, "Managing options"](#), on page 59.

### 5.11 Device documentation

You can export the R&S ZNH OSA document from the instrument.

1. Press [SETUP] key.
2. Select "User Preference" softkey.
3. In the "User Preferences" dialog box, select the "Export" menu item.  
The R&S ZNH displays the file manager window to export the documentation.

4. Select the desired file location in the file manager window to export the documentation.

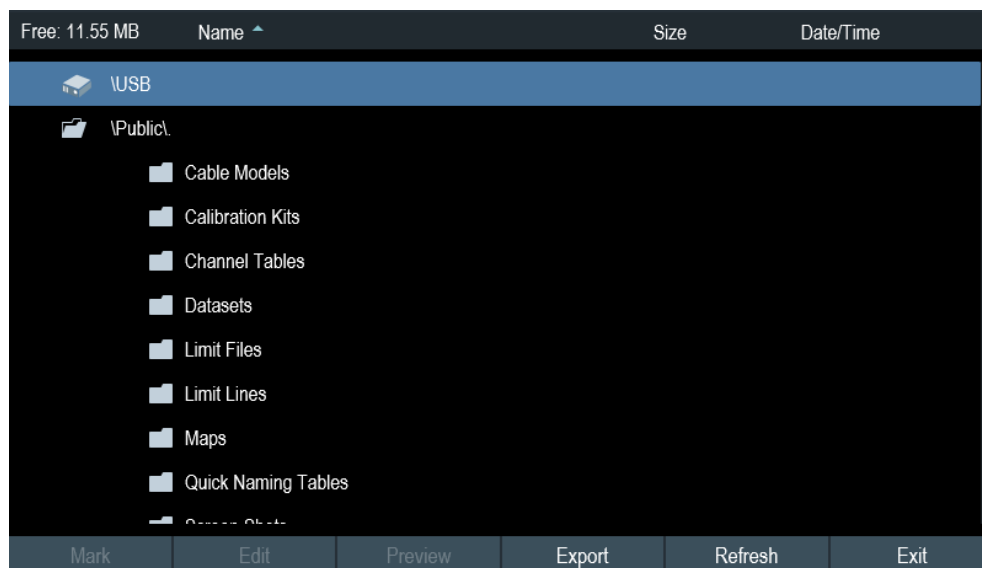

5. Select "Export" to export documentation from the instrument.  
The R&S ZNH export the documentation into the selected file location.

## 6 Working with the measurement wizard



When testing antennas and making measurement which involves complex signals, it is often necessary to perform a sequence of standardized and recurring measurements, often in an environment that is not easily accessible. To make sure that measurements are performed as required and to avoid a constant adjustment of parameters, the R&S ZNH features a measurement wizard.

The measurement wizard allows you to combine several individual measurement configurations to a sequence of measurements (or measurement set). As all relevant parameters have been set before the actual measurement and cannot be changed once the measurement procedure has begun, the wizard is a good way to avoid mistakes and save time when setting up measurements. You can use the wizard for measurements in all the operating modes.

Note that it is necessary to install and use the R&S InstrumentView software package if you want to configure the measurement steps and parameters in the measurement wizard.

For details on the individual measurements you can perform with the wizard, refer to the corresponding chapters.

- [Chapter 8, "Vector network analysis"](#), on page 153
- [Chapter 7, "Cable and antenna test mode"](#), on page 107
- [Chapter 9, "Vector voltmeter"](#), on page 190
- [Chapter 10, "Power meter"](#), on page 193
- [Chapter 11, "Performing pulse power measurements"](#), on page 203

You can use the wizard for measurements in all operating modes.

The following chapters illustrates the wizard measurements used in the "Cable & Antenna" mode.

Note: It is necessary to install and use the R&S InstrumentView software package if you want to access the measurement wizard.

### 6.1 Performing and configuring measurements

Before you can use the measurement wizard, you have to define a measurement set using the "Wizard Set Editor" in the R&S InstrumentView software package.

The R&S InstrumentView software package is delivered with the R&S ZNH. The latest version is also available for download on the R&S ZNH website at <http://www.rohde-schwarz.com/product/znh.html>.

After creating the measurement wizard set using the R&S InstrumentView, transfer the file to the R&S ZNH.

For more information of the "Wizard Set Editor", see the R&S InstrumentView manual.



### Load the measurement wizard

Now that the measurement set is available on the R&S ZNH, you can perform the measurement wizard.

1. Press [Wizard] key.  
The R&S ZNH opens the wizard dialog box. See [Figure 6-1](#).

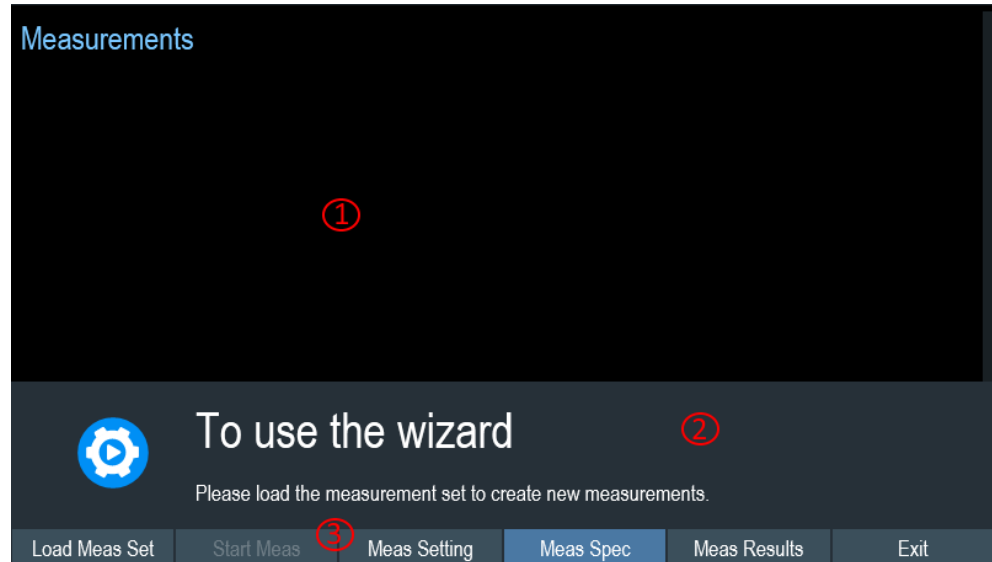

**Figure 6-1: Wizard dialog box**

- 1 = Measurement wizard dialog box
- 2 = Measurement wizard message box
- 3 = [Softkeys](#) menu of measurement wizard application

2. Select "Load Meas Set" softkey.  
The R&S ZNH opens the file manager to select the measurement wizard set.
3. Select the desired measurement wizard set from the file manager.
4. Select "Load" softkey to confirm the selection.  
The R&S ZNH loads the measurement wizard set.

### Measurement setting

The parameters highlighted in the measurement setting dialog are configurable during the start of the measurement. See [Figure 6-2](#).

1. Select "Meas Setting" softkey.  
The R&S ZNH opens the "Meas Setting" dialog box.
2. Select the desired menu item in the "Meas Setting" dialog box.  
Note that some of the parameters are read-only information. See [Table 6-1](#).

<b>General</b>	Measurement Definition	
	User	
	No. of Steps to Perform	0
	Description	
<b>Site</b>	Site Name	
	Comments	
	GPS Position	not connected
<b>Cable Definition</b>	Use Wizard Cable Settings	Off
	Cable Model	<none>
	Clear Cable Model	Clear
	Cable Length	20 m
<b>Calibration Settings</b>	Default Calibration	None
	Use Stored Calibrations	On

Figure 6-2: Measurement setting dialog

Table 6-1: Measurement setting parameters

Measurement parameters		Descriptions
"General"	User	Name of the person that performs the measurement.
	Measurement Definition	Name of the measurement wizard set. This field is a read-only field that shows the measurement name as defined in the R&S InstrumentView software package.
	Number of Steps to Perform	Number of individual measurements in the measurement sequence as defined with the R&S InstrumentView software package.  The field allows you to reduce the number of individual measurements and perform only those measurements that are necessary. If you reduce the number of measurements, the R&S ZNH omits the last measurement in the sequence.  You can edit this field only if you turned on the "Allow Variable Number of Sequence Steps" in the "Wizard Set Editor" of the R&S InstrumentView software.
	Descriptions	Short description of the measurement task. This field is a read-only field that shows the description as defined with the R&S InstrumentView software.
"Site"	Site Name	Location of the measurement.

Measurement parameters		Descriptions
	Comments	Comments about the measurement, e.g. the external conditions during the measurement.
	GPS Position	Displays the GPS information. See <a href="#">Chapter 4.2.2, "Using the GPS receiver"</a> , on page 41.
"Cable Definition"	Use Wizard Cable Settings	Select the usage of cable characteristics as defined in the measurement set.  Select "On" to use the predefined cable characteristics or "Off" to redefine the cable model and cable length in R&S ZNH. In the case, if "On" is selected, the parameters below will be locked.
	Cable Model	Cable model that you perform the measurement on. You can define a cable model with the R&S ZNH software, but can also change the cable model on short notice, if necessary. See <a href="#">Chapter 7.2.1.3, "Creating a cable model"</a> , on page 130.
	Clear Cable Model	Deactivates the currently active cable model. See <a href="#">Chapter 7.2.1.2, "Clear cable model"</a> , on page 130.
	Cable Length	Length of the cable that you perform the measurement on.
"Cable Settings"	Default Calibration	Calibration that was defined when creating the wizard set in the R&S InstrumentView software.
	Use Stored Calibrations	If set to "On", the wizard uses the calibration stored in the R&S ZNH. If set to "Off", the wizard uses the calibration defined in the R&S InstrumentView software.

### Measurement specification

The measurement specification dialog box displays the measurement step sequences and the individual performed measurement status. See [Figure 6-3](#).

- ▶ Select "Meas Spec" softkey.  
The R&S ZNH opens the "Meas Spec" dialog box.

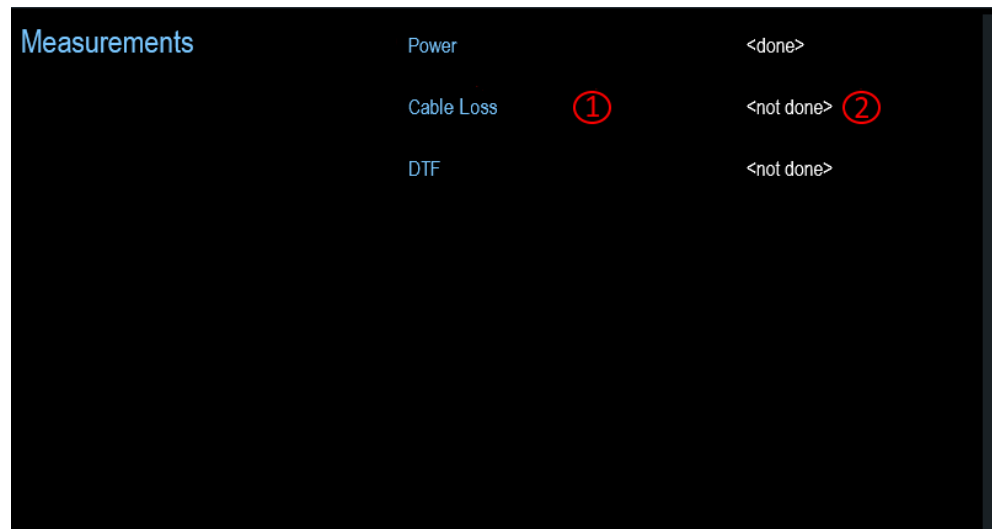

Figure 6-3: Measurement specification dialog box

1 = Measurement step in a wizard set

2 = Individual measurement step status

## Performing a sequence of measurements



### Calibration data

The R&S ZNH adds the calibration data of each calibration you perform to a calibration data folder available on its internal memory. Each dataset in the calibration data folder is unique for a particular calibration method and a particular measurement configuration.

Note that the calibration is only valid for the instrument it has been performed on.

Before you start a measurement sequence with the measurement wizard, the R&S ZNH compares the contents of the calibration data folder to the measurement configurations and required calibration methods in the measurement sequence.

- If the R&S ZNH has already been calibrated for a particular configuration, it restores that data. Another calibration is not necessary.
- If the R&S ZNH has not been calibrated for a particular configuration yet, calibration becomes necessary. The new calibration data is added to the calibration data folder.

Therefore, calibration is necessary only for calibration methods that have not been used for a particular measurement configuration before.

However, it is recommended to perform calibration regularly to keep measurements as accurate as possible.

You can delete obsolete calibration data from the folder:

```
\Public\Calibration Data
```

Now that you have updated all [measurement setting parameters](#) concerning the measurement task, you can start the measurement procedure.

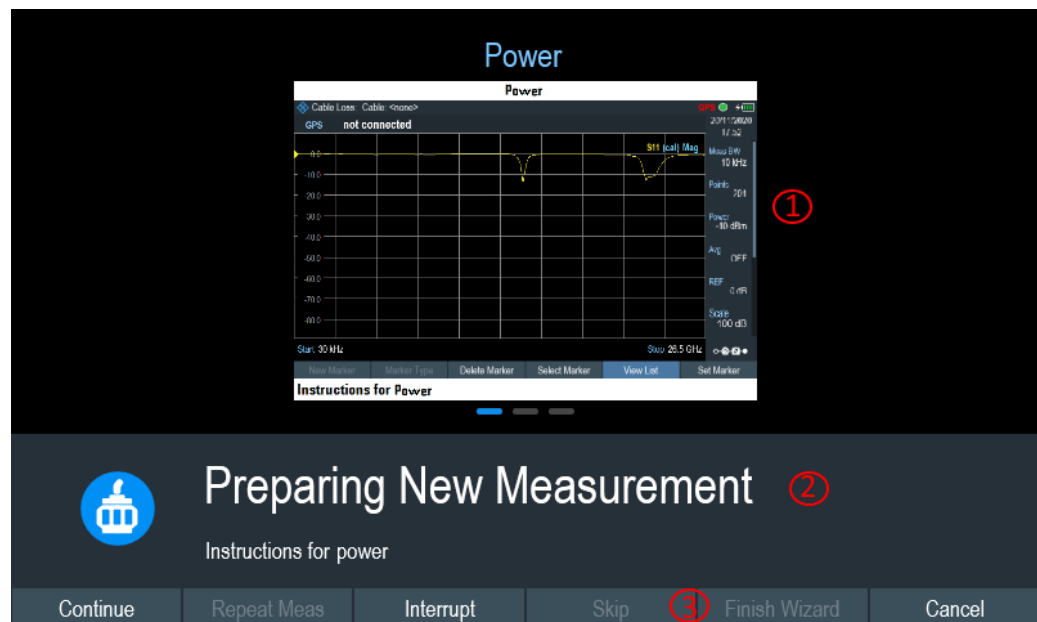

Figure 6-4: Perform wizard measurement dialog box

- 1 = Image of a measurement step defined in the R&S InstrumentView software package.  
 2 = Wizard message box  
 3 = See [Table 6-2](#)

1. Select "Start Meas" softkey.

If you have not yet calibrated the R&S ZNH for the measurement, it asks you to perform the calibration routine. The stages of the calibration depend on the defined calibration routine. See [Chapter 7.1.9, "Calibrating measurements"](#), on page 124 and ["Calibration data"](#) on page 100.

After having successfully calibrated the R&S ZNH, it starts to go through the measurements that are part of the measurement wizard set. The sequence of the measurements is defined in the R&S InstrumentView.

Before the start of each measurement, the R&S ZNH displays a message "Preparing New Measurement" in the wizard message box.

The message box contains information and instructions on how to prepare and perform the measurement that you have defined in the R&S InstrumentView software.

2. At each measurement step, you have several options:

- Select "Continue" softkey.  
 The R&S ZNH finishes the current measurement and opens the measurement wizard dialog box. See [Figure 6-5](#)

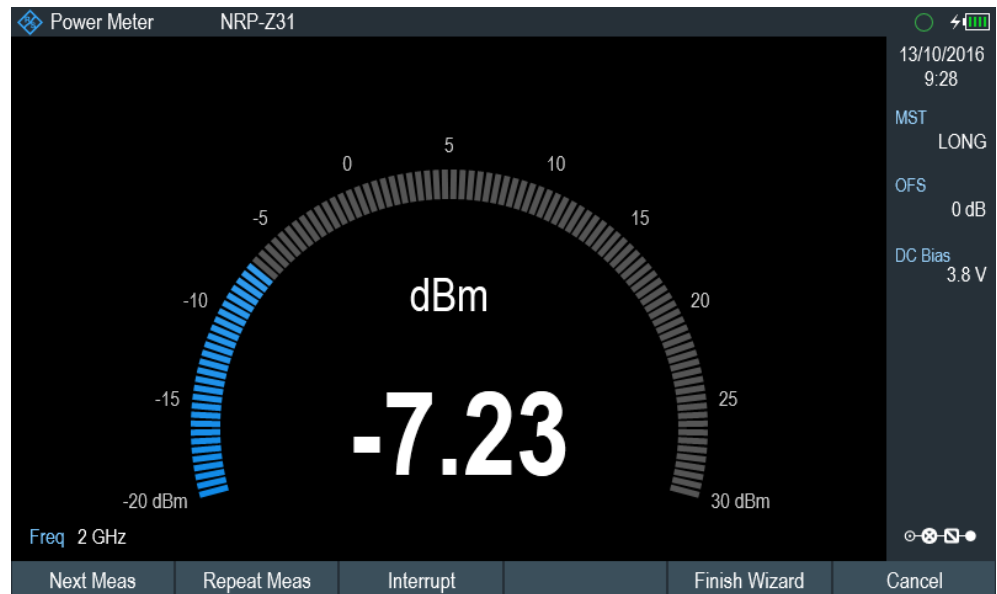

Figure 6-5: Measurement wizard dialog

- Select "Next Meas" softkey to proceed to the next measurement step in the measurement sequence.
- Select "Repeat Meas" softkey if the result does not match your expectation and you want to validate the result again.
- Select "Interrupt" softkey if the result does not match your expectation and you want to find the origin of the problem by using a different settings or measurement than those defined in the wizard.
- Select "Finish Wizard" softkey to end the measurement sequence.
- Select "Cancel" softkey if at any time the result does not match your expectation and you want to abort the measurement.

The R&S ZNH prompts you to save measurement result and exit the wizard measurement.

- Select "Interrupt" softkey.

The R&S ZNH opens the wizard interrupt dialog box.

There are three selections in the wizard interrupt dialog box, you can either:

- Select "Leave Menu" softkey to proceed and perform the necessary reconfiguring of the measurement. The R&S ZNH goes to the current measurement environment which you can analyze the measurement settings and make the necessary reconfiguration on the measurements.

After you have completed the reconfiguration on the measurement, press [WIZARD] key to return back to the wizard interrupt dialog box

- Select "Resume Sequence" softkey to resume back to the measurement.
- Select "Cancel" softkey to abort the wizard measurement.

- Select the "Skip" softkey.

The R&S ZNH skips a single measurement step and continue the subsequent measurement step.

Note: Alternatively, you can swipe horizontally to the left direction to skip a wizard measurement. See [Chapter 5.1.9, "Skip wizard measurement"](#), on page 76.

- Select "Cancel" softkey.

The R&S ZNH displays a message "Cancel Incomplete Wizard Sequence" in the wizard message box.

Select "YES" to abort the wizard measurement or "NO" to continue.

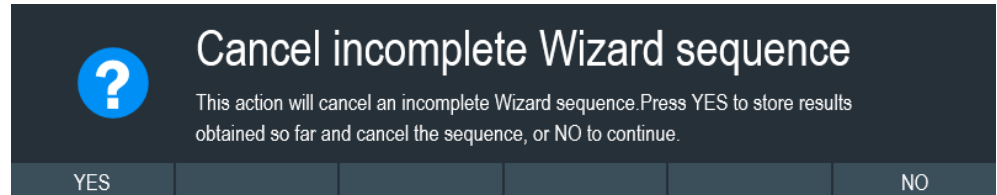

This is followed with a message prompt to save measurement result. The R&S ZNH displays a message "Save Wizard Measurement Results" in the wizard message box.

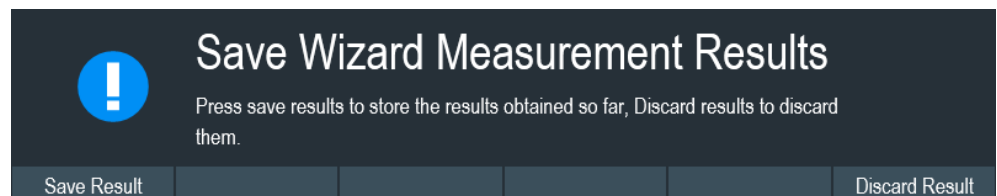

Select "Save Result" to save the measurement results or "Discard Result" to discard the measurement results.

3. After each measurement is completed, the R&S ZNH displays a message "Measurement Done" in the wizard message box. Select "Continue" softkey to proceed to the next measurement step (if any).



**Note:** Changing cable characteristics. If necessary, you can define different cable characteristics (cable model and length) after each individual measurement. This is useful, for example, if you want to do the same measurements on different cables at one go.

This feature is available when you activated the "Prompt User to Change Cable Settings" in the "Wizard Set Editor" of the R&S InstrumentView software.

When this function is activated, the R&S ZNH asks you to select new cable characteristics during the preparation of a measurement.

- Select "Yes" softkey if changes are required and select new cable characteristics before proceeding with the measurement.
  - Press "No" softkey if changes are not required and proceed with the measurement.
4. After all the measurements are completed, the R&S ZNH displays a message "All Measurements Done" in the wizard message box.

Select "Continue" softkey. The R&S ZNH prompts you to save or discard the measurement results.

Select "Save Result" softkey to save the results on the selected storage device or "Discard Result" softkey to discard all the measurement results.



## All Measurements Done

**Table 6-2: Softkey in the measurement wizard**

Softkey	Description
"Next Meas"	The R&S ZNH proceeds to perform the measurement.
"Continue"	The R&S ZNH finishes the current measurement and begins with the next measurement by showing the necessary preparation instruction.
"Repeat Meas"	Repeat the current measurement
"Interrupt"	<p>If you interrupt the measurement sequence, you can change the different settings or measurements as if wizard is not in used. The R&amp;S ZNH keeps the results of measurement you have already performed.</p> <p>When you finished reconfigured the measurement, you can resume back to the measurement sequence.</p>
"Skip"	<p>Skip a single measurement step and continue the subsequent measurement step</p> <p>Skipping individual measurements is possible when you turn on "Allow to skip measurements and finish wizard sequence" in the "Wizard Set Editor" of the R&amp;S InstrumentView software package.</p>
" Cancel"	<p>Abort wizard measurement. The R&amp;S ZNH displays a message "Cancel Immediate Wizard Sequence" in the message box.</p> <p>If wizard measurement is aborted, the R&amp;S ZNH displays a message "Save Wizard Measurement Results" in the message box.</p> <p>If wizard measurement result is saved, the R&amp;S ZNH returns to the last saved measurement result trace window. If the result is discarded, the R&amp;S ZNH returns to the <a href="#">measurement dialog box</a>.</p>
"Exit"	Exit wizard measurement.
"Finish Wizard"	<p>Ends the measurement sequence and returns to the "Measurement Wizard" dialog box. The results of the measurements you have already finished are kept in the memory of the R&amp;S ZNH.</p> <p>Ending the sequence is possible when you turn on "Allow to skip measurements and finish wizard sequence" in the "Wizard Set Editor" of the R&amp;S InstrumentView software package.</p>



Softkey	Description
"Save Result"	Save result of the measurements performed in the wizard set. See " <a href="#">Measurements result</a> " on page 105
"Discard Result"	Discard measurement results.

### Measurements result



#### Limited internal memory

If you have to store the results on the internal memory, make sure that there is enough space left to store them or else the results might get lost. If the space is not enough, you can delete old data with the file manager.

For more information, see [Chapter 5.8.3, "Deleting datasets"](#), on page 93.



#### Measurement wizard results

All the measurement wizard results are stored in the wizard result folder during the process of the measurement wizards. These stored results will not be saved until you do a [Save Result](#) at the end of the wizard measurement.

The results for a measurement set consist of several files, each file corresponding to one of the performed measurements. For easy evaluation, the R&S ZNH includes the name of the measurement as defined in the wizard dialog or R&S InstrumentView.

All result files that belong to a measurement set are stored in the same directory. The directory is named after the measurement name and site. The syntax is 'site-name\_measurement\_#'.

The R&S ZNH adds numbers in ascending order to the files and directories if you perform a measurement or measurement set more than once.

## 6.2 Evaluating results

The R&S InstrumentView software package provides functionality to evaluate results and compile measurement reports. However, before you can start to evaluate the results you have to download the results to your computer. See "[Data synchronization](#)" on page 88.

The report generator function in R&S InstrumentView allows you to create measurement reports for the full measurement set or a selection of dataset only. You can also perform simple tasks like activating or deactivating markers that have been set during the measurement.

1. Select "Report Generator" menu item in the R&S InstrumentView  
The R&S InstrumentView opens the "Report Generator" dialog box that provides all functionality to manage measurement sets.
2. Select the measurement sets that you want to include in the report.

3. Select the reporting parameters checkmarks that you want to show in the report, e.g. checkmark to show marker data.
4. Select "Generate" button to create the report.

For more information on the report generator function, see the R&S InstrumentView user manual.

## 7 Cable and antenna test mode

The cable and antenna test (CAT) mode provides functionality to measure cables and antennas of transmission equipment in wireless telecommunication systems.

In a perfect system, the signal would arrive at the antenna without any losses and be transmitted with the required power and frequency. In reality, however, you can encounter many possible mechanical defects in the system that cause a deterioration of the transmission quality. See [Figure 7-1](#) for the typical defects in a transmission system.

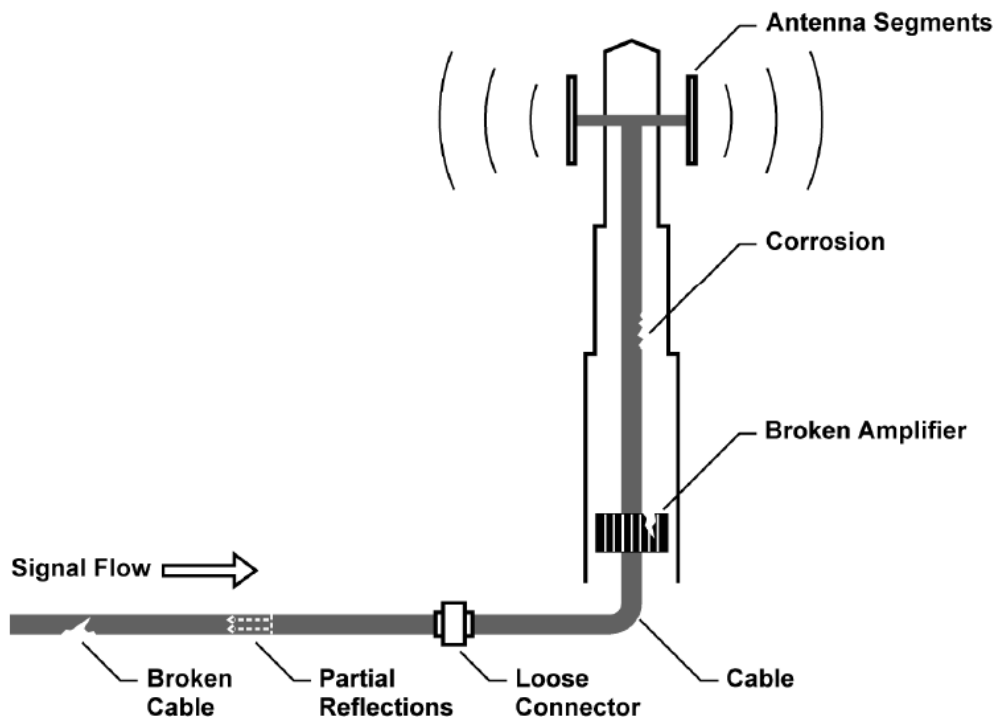

*Figure 7-1: Typical defects in a transmission system*

The R&S ZNH provides the necessary functionality to test the system equipment for its characteristics and identify faults when it is being installed or maintained.

- [Retrun Loss Measurements](#)
- [SWR](#)
- [Distance to Fault Measurements](#)
- [1-Port Cable Loss Measurements](#)
- [Transmission Measurements](#)
- [Waveguide Measurements](#)
- [Smith Chart](#)
- [Phase Measurement](#)

## Test setup



### Signal source

A tracking generator is available for the signal source. See [Chapter 7.2.4, "Configuring the tracking generator"](#), on page 138.

A typical test setup for cables and antennas includes the R&S ZNH, an RF cable (R&S FSH-Z320, order number 1309.6600.00), a calibration standard (R&S FSH-Z28/Z29, order number 1300.7810.03 / 1300.7610.03) and the cable under test. See [Chapter 7.1.9.2, "Calibration methods"](#), on page 125.

Cable and antenna tests also require a signal source which is already part of the R&S ZNH hardware. The signal source transmits a reference signal to the test port.

1. Connect the RF cable to the RF input.
2. Connect the test cable to the RF cable.
3. Select the "DC Bias" softkey.  
The R&S ZNH opens an input field to specify the DC bias voltage.  
For measurement on DUTs that need an external voltage supply (e.g. power amplifiers), you can use the optional internal DC bias option (R&S ZNH-K10, order number 1334.6846.02) to supply the voltage.
4. Enter the required voltage.  
For more information, see ["Configuring the BIAS output port"](#) on page 41.

By default, the R&S ZNH is in the VNA mode after you have turned it on. To switch to the CAT mode, proceed as follows.

1. Press [MODE] key.
2. Select "Antenna & Cable" softkey.  
The R&S ZNH starts the antenna and cable test (CAT) mode.

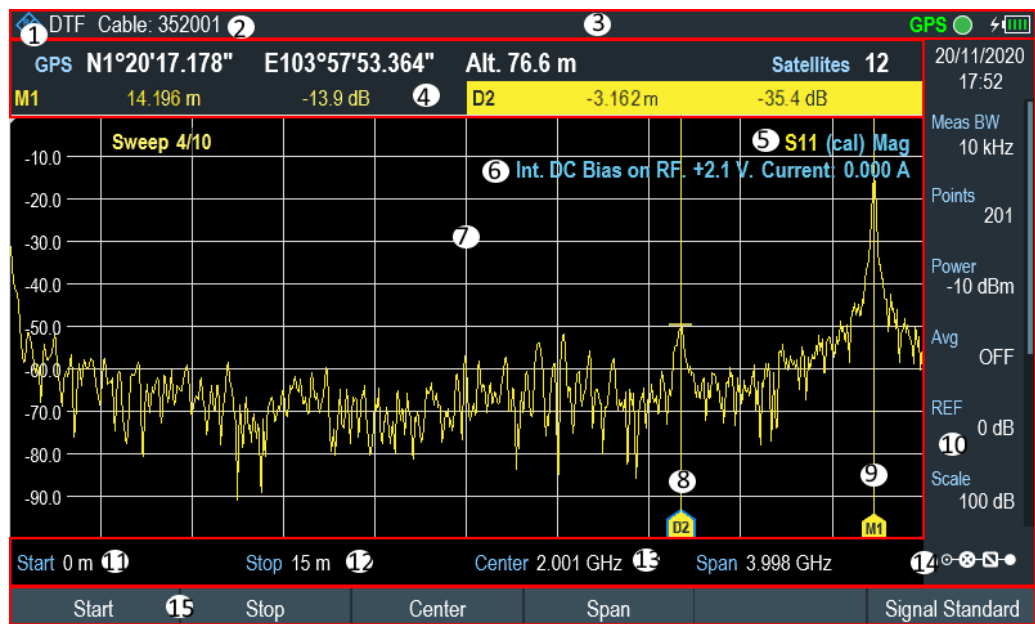

Figure 7-2: Screen layout of cable and antenna test mode

- 1 = Measurement mode
- 2 = Cable model
- 3 = Title bar
- 4 = Measurement result view
- 5 = Calibration status line: (S-matrix, calibration status, measurement format)
- 6 = Internal DC bias status: (connector type, voltage, current)
- 7 = Measurement trace window
- 8 = Delta marker
- 9 = Marker
- 10 = Parameter view
- 11 = Cable start length
- 12 = Cable stop length
- 13 = Cable frequency information
- 14 = Config Overview
- 15 = CAT softkey menu

- [Performing cable and antenna measurements](#)..... 109
- [Configuring cable and antenna tests](#)..... 129
- [Analyzing measurement results](#)..... 140

## 7.1 Performing cable and antenna measurements

In order to get an idea about the problems in a transmission system that is as accurate as possible, the R&S ZNH features several measurements. Each measurement shows a different aspect of the cable characteristics.

- [Reflection measurements](#)..... 110
- [1-Port cable loss measurement](#)..... 113
- [Transmission measurements](#)..... 114
- [Waveguide measurements](#)..... 116

• <a href="#">Distance to fault measurements</a> .....	118
• <a href="#">Time domain reflectometry (TDR)</a> .....	120
• <a href="#">Smith chart</a> .....	121
• <a href="#">Phase measurement</a> .....	123
• <a href="#">Calibrating measurements</a> .....	124

### 7.1.1 Reflection measurements

The reflection measurement (S11, S22) is a good way to get an idea if the transmission system works properly. If unusual amounts of signal power are being reflected, you can guess that there is something wrong in the system.

A reference signal is transmitted along the transmission system, and this signal is reflected back by a discontinuity along the transmission line, usually by an impedance mismatch. This reflected signal is measured and compared with the reference signal to determine the loss of power.

The reflection measurement can be performed in the following measurement formats:

- **Magnitude (return loss in dB)**  
Return loss is power loss in dB, measured over the specified frequency range of the transmission system. The return loss in dB is the default measurement format in the reflection measurement.
- **SWR**  
The standing wave ratio, SWR provides the ratio of the maximum and minimum AC voltages along the transmission line caused by the reflections.
- [Chapter 7.1.8, "Phase measurement"](#), on page 123
- [Chapter 7.1.7, "Smith chart"](#), on page 121

1. Press [MEAS] key
2. Select "Meas Mode > Return Loss" softkey to perform return loss measurement. The R&S ZNH starts the reflection measurement with default measurement format over its entire frequency range.
3. Alternatively, select "Meas Mode > RL +Trans" for [combined measurement](#). The R&S ZNH displays the "RL +Trans" measurements over its entire frequency range.
4. To perform S22 measurement, select "Port 2" menu item from "Driving Port" softkey. The R&S ZNH starts the S22 reflection measurement.
5. To change the measurement format, press [FORMAT] key. The R&S ZNH displays the available measurement formats (softkey) for "Return Loss" measurement.
6. Select the required format softkey ("dB Mag", "Lin Mag", "Phase", "Smith", "SWR"). The R&S ZNH starts the reflection measurement over its entire frequency range with the selected measurement format.

For more information on "Phase" and "Smith" measurements, see [Chapter 7.1.8, "Phase measurement"](#), on page 123 and [Chapter 7.1.7, "Smith chart"](#), on page 121 respectively.

[Figure 7-3](#) shows an example of a reflection measurement in magnitude dB and SWR measurement format without any major faults in the cable or the antenna.

See also measurement formats for [Chapter 7.1.7, "Smith chart"](#), on page 121 and [Chapter 7.1.8, "Phase measurement"](#), on page 123.

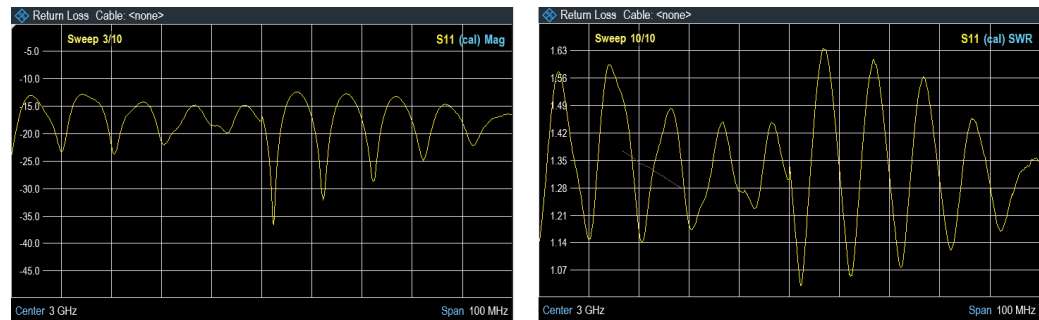

**Figure 7-3: Reflection measurement**

### Combined measurements

You can combine reflection measurement with [Chapter 7.1.3, "Transmission measurements"](#), on page 114 and have the measurements display together for easy evaluation.

1. Press [MEAS] key.
2. Select "Meas Mode > RL + Trans" menu item.  
The R&S ZNH displays the combined measurements over its entire frequency range. See [Figure 7-4](#).  
Note: The highlighted S21 trace measurement window is the window in focus. Markers added, removed or moved over here are coupled to the S11 trace measurement.

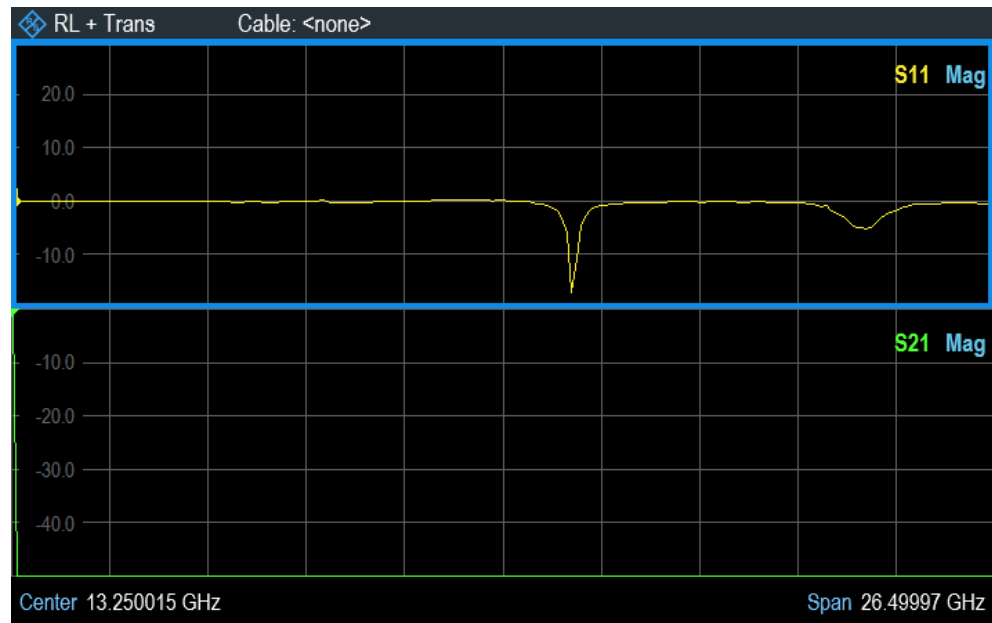

Figure 7-4: RL + Trans measurement display

You can perform reflection measurements on the complete system or on individual components of the system. If you measure while two or more system components are connected, the results of the reflection measurement are an aggregate over these components. Therefore you can only see the aggregated magnitude of the reflected power in a specified frequency range.

To draw conclusions about which component is affected and to determine the location of the fault, you need to perform further analysis using other measurements.

#### 7.1.1.1 Managing S-Parameters file

The R&S ZNH is able to export the measurements trace to S1P, S2P file in Touchstone format 1.1.

To export the file, do the following:

1. Press [SAVE/RECALL] key.
2. Select the "Export" > "Export SnP" softkey to export file in Touchstone format 1.1. For exporting of file in CSV format, see [Chapter 5.8.4, "Export datasets"](#), on page 94.

The R&S ZNH opens the "Export" dialog box.



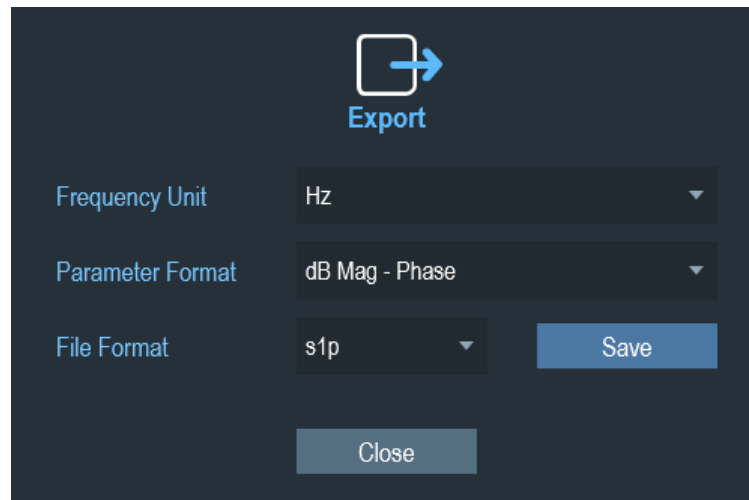

3. Define the required parameters to export the S-parameter file:
  - "Frequency Unit": Frequency unit of spectrum ("Hz", "kHz", "MHz", "GHz")
  - "Parameter Format": Select the exported [parameter format](#) on the measurement ("Real - Imaginary", "dB Mag - Phase", "Lin Mag - Phase")
  - "File Format": s1p or s2p file format
4. Select "Save" to save the export configuration.  
The R&S ZNH opens the file manager dialog.
5. Select the storage device and folder that you want to save the data.
6. Enter a filename in the input field of "Save Dataset" dialog box.  
The default filename is "Measurementxxx" which "xxx" is the new number in ascending order.  
The file extension for the S1P and S2P is \*.s1p and \*.s2p respectively.
7. Press the rotary knob to confirm the entry.  
The R&S ZNH saves the file.
8. To delete the file, see [Chapter 5.8.3, "Deleting datasets"](#), on page 93.

### 7.1.2 1-Port cable loss measurement

The 1-port cable loss measurement evaluates the power attenuation of a cable over a specified frequency range in dB on an open-ended cable. The amount of power that gets absorbed depends on the frequency and length of the cable.

The 1-port cable loss measurement can be performed in the following measurement formats:

- Normal
- (Short + Open) / 2  
Additional steps are required to terminate the end of the cable under test with a short and open before the cable loss measurement is performed.



## (Short + Open) / 2

Please connect a "SHORT" to the end of the cable under test.

1. Press [MEAS] key.
2. Select "Meas Mode > Cable Loss" softkey.  
The R&S ZNH displays a submenu to select measurement format.
3. Select "Normal" or "(Short + Open) / 2" menu item.  
The R&S ZNH evaluates the cable loss over its entire frequency (span) in dB.

The numerical result is the average cable loss over the specified span. [Figure 7-5](#) shows the typical results of a cable loss measurement with a steadily declining loss over the selected frequency range and several maximums and minimums.

By default, the R&S ZNH evaluates the cable loss over its entire frequency range (full span of the R&S ZNH). When you reduce the span, make sure to define a span that is appropriate for the measurement, especially for high center frequencies, and consider the cable length and the wavelength of the selected center frequency. For a typical cable loss trace, you should select a span that is large enough to evaluate at least one peak and one minimum. Otherwise, the result might not be valid.

If the cable loss is constant over a large span (for example if there is low center frequencies), you can select any span.

However, if the cable loss is greater than 20 dB, you are better off using the ([Transmission](#)) measurement, because the cable loss measurement might yield invalid results.

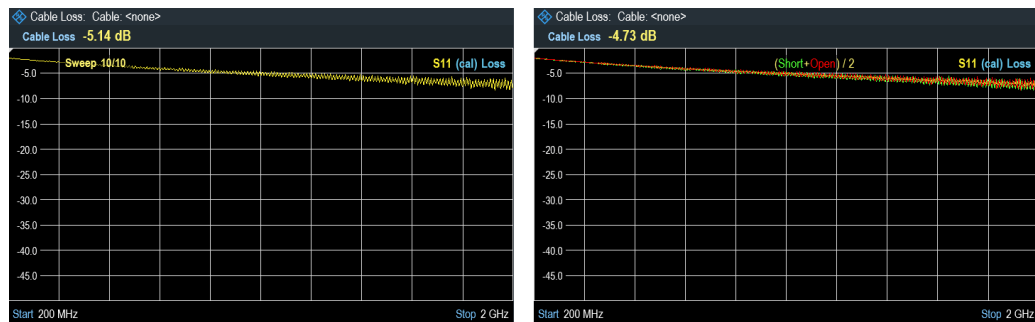

Figure 7-5: 1-port cable loss measurement

### 7.1.3 Transmission measurements

You can use transmission measurement (S21, S12) to test if a radio signal can travel through the line without losses. This type of forward transmission measurement helps to find faults by displaying the magnitude of the reflections in dB in a specified frequency range.

For ease of evaluation, you can also display the combination of transmission measurement with reflection measurement, see "[Combined measurements](#)" on page 111.

Typically you perform transmission measurements on a filter to test if it works according to the datasheet or test the isolation of two antennas (e.g. two receiving antennas or a receiving and a transmitting antenna).

The transmission measurement can be performed in the following measurement formats:

- Magnitude (return loss in dB)
- [Chapter 7.1.8, "Phase measurement"](#), on page 123

For more information on the test setup and settings, see [Chapter 4.5, "Measuring transmissions"](#), on page 62.

1. Press [MEAS] key.
2. Select "Meas Mode > Transmission" softkey.  
By default, the R&S ZNH starts the forward transmission measurement, S21 with default measurement format over its entire frequency range.
3. Alternatively, select "RL +Trans" for [combined measurement](#).  
The R&S ZNH displays the "RL +Trans" measurements over its entire frequency range.
4. To perform S12 measurement, select "Port 2" menu item from "Driving Port" softkey.  
The R&S ZNH starts the S12 transmission measurement.
5. To change the measurement format, press [FORMAT] key.
6. Select the "dB Mag" or "Phase" softkey.  
The selected measurement format is used for the display of transmission measurement.
7. If "Phase" is chosen, select "Wrap" or "UnWrap" softkey.  
By default, "Wrap" is the default phase measurement format.

The following shows the results of a forward transmission measurement on a lowpass filter. The results show the characteristics of how the filter performs.

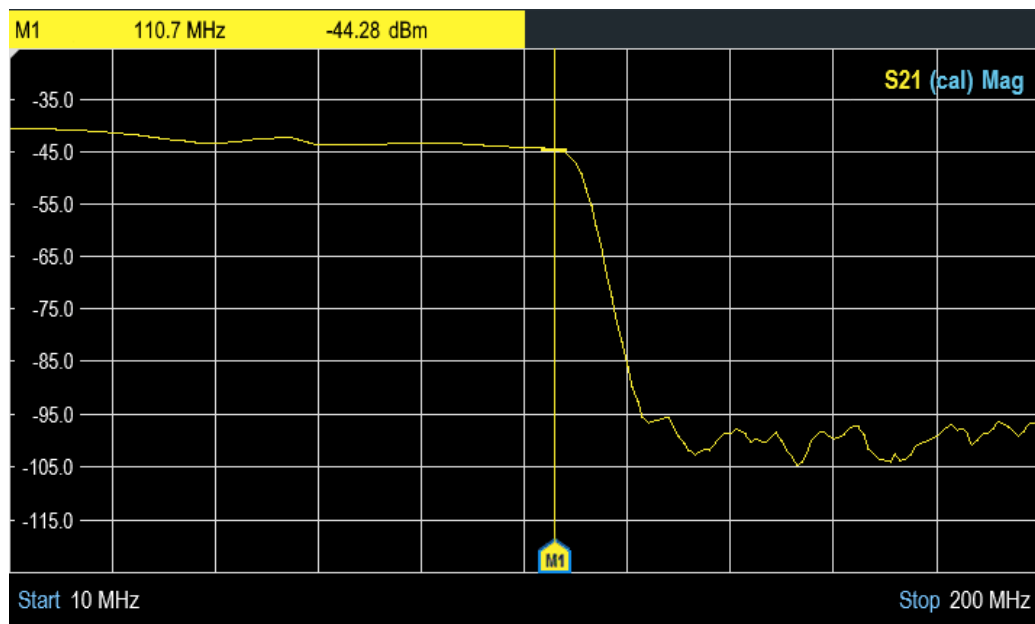
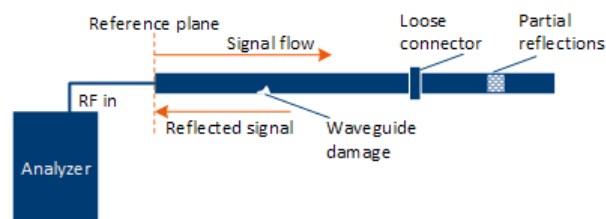

Figure 7-6: Transmission measurement

### 7.1.4 Waveguide measurements

The waveguide measurement is a modification of the cable measurement, with a waveguide being the DUT instead of a cable. The main difference to cable measurements is that waveguide measurements take into account the different speed of wave propagation in a waveguide, depending on the frequency. The test setup and purpose is similar to other cable measurements.

The purpose is to find possible faults in the waveguide, for example broken parts in the waveguide or loose connections between waveguide elements. A test setup consists of the R&S ZNH, a waveguide and an adapter to connect the analyzer's RF input to the waveguide at its reference plane. Like other reflection measurements, the RF input also feeds a signal into the waveguide.



Like cable measurements, you can:

- Determine the distance to a fault in the waveguide ([Distance-to-Fault](#) result)
- Check how much energy is reflected ([Reflection](#) result display)

The R&S ZNH starts the waveguide measurement over the frequency range setting. As long as a waveguide measurement is configured, the results (distance-to-fault,

reflection or frequency spectrum) refer to a waveguide. A waveguide measurement can be configured either with [calibration](#) or [configuration](#).

#### 7.1.4.1 Calibrating waveguide measurement

Before we perform waveguide measurement, a calibration on the waveguide is required. Waveguide calibration requires a special calibration kit which consists either of the following:

- A short, an offset short and a match
- A short and two offset shorts
- A through, reflection and a line

You can define the characteristics of this calibration kit using the with the functionality of the R&S InstrumentView software package and transfer it to the R&S ZNH. Otherwise, the calibration method is the same as for all measurements.

1. Disconnect the DUT from the waveguide.
2. Load the calibration kit. See [Chapter 4.2.8, "Configuring calibration kit model"](#), on page 50. A waveguide kit is detected automatically.
3. Press [SETUP] > "Cable" > "Cutoff Frequency" to enter the waveguide cutoff frequency.  
The cutoff frequency is the frequency below which the wave does not propagate. The cutoff frequency depends on the geometry of the waveguide and can be found in the waveguide datasheet.
4. Alternatively, press [CAL] key > "Cal Config" to change "Cutoff Frequency".

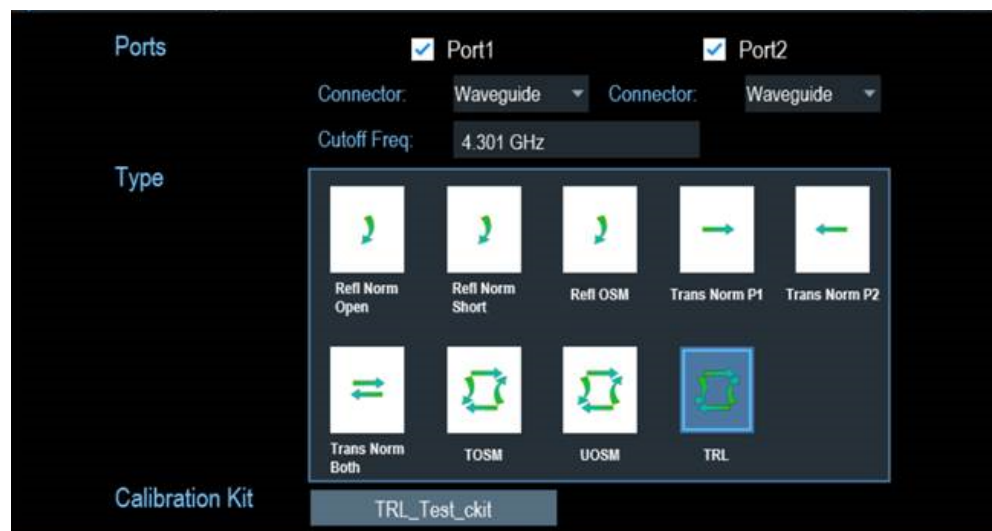

Figure 7-7: Calibration dialog for waveguide configuration

5. Select "Start Cal" to start calibration.
6. Connect all calibration standards one after another as instructed.

For details of the calibration procedure, see [Chapter 8.1.3, "Performing calibration"](#), on page 157.

#### 7.1.4.2 Configuring waveguide measurement

When a waveguide calibration is performed, the instrument is automatically configured for waveguide measurements and this step is not needed.

However, since waveguide calibrations require special calibration kit and may not be always available on site, it is possible to configure DTF measurement and apply the waveguide propagation corrections on a regular cable measurement.

1. Press [MEAS] key.
2. Select the "Meas Mode" > "DTF" > "Cable Config" > "Use Waveguide" to enter cut-off frequency.  
Note that you can select a cable model, but this setting has currently no effect.

#### 7.1.5 Distance to fault measurements

The distance to fault (DTF) measurement determines the exact location of possible faults in a transmission system. If you connect the end of the cable to the R&S ZNH, the DTF measurement shows you the exact distance to the fault (in meter or feet), regardless by what the fault is caused. In addition, the measurement shows the degree of the fault in dB. From this information, you can determine the component that has the fault and its seriousness.

In order to determine the distance to a cable fault, the R&S ZNH measures the reflections of the cable under test in the frequency domain. The R&S ZNH first determines the magnitude of the reflections for a particular frequency by comparing the phase of the reflected signal and a reference signal created by the signal source. It then performs an inverse fast fourier transformation (IFFT) on the signal that has been received. In combination with the characteristics of the cable model, the R&S ZNH is able to determine the distance the reflections have been traveling.

Because of its sensitivity by first measuring in the frequency domain and subsequent IFFT, the measurement is able to locate faults in a cable accurately. To keep this accuracy, the R&S ZNH also accounts for any attenuation that occurs over distance in a cable.

If you are measuring the cable only, make sure to terminate the other end into a load.

The DTF measurement can be performed in the following measurement formats:

- Magnitude (return loss in dB)
  - SWR
  - Impedance
1. Press [MEAS] key.
  2. Select "Meas Mode > DTF" softkey.

The R&S ZNH calculates the distance to cable faults with default measurement format.

3. To change the measurement format, press [FORMAT] key.
4. Select the required format ("dB Mag", "SWR" or "Impedance") softkey for measurement.

The R&S ZNH calculates the distance to cable faults on the selected measurement format.

Figure 7-8 shows an example of a DTF measurement in magnitude, SWR and impedance measurement format. The peaks that the trace shows at the marker positions are possible faults. Depending on the distance, you can also get an idea of the component that is defective.

Marker 1, M1 for example, shows a defect in the cable. Marker 2, M2 shows a fault at the end of the cable, probably a bad or loose connection.

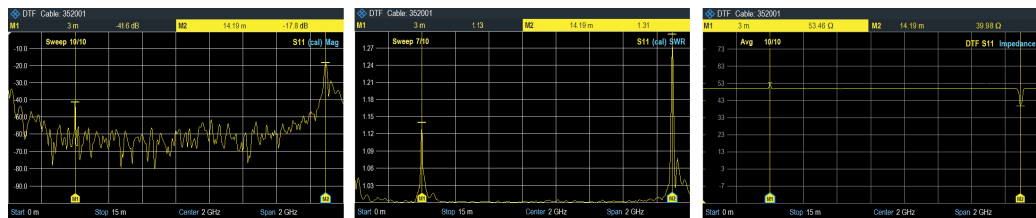

Figure 7-8: Distance to fault measurement in different measurement format

### Split screen

Using split screen, you can display the DTF measurement in both time and frequency domain. The main DTF measurement is displayed in the upper screen window (frequency domain) and the selection of reflection (Refl) or time domain reflectometry (TDR) measurement is displayed in the lower screen window (time domain). The Y-axis on both screen window depends on the selected measurement format (magnitude, SWR or impedance) in DTF/TDR measurement.

The marker and limit line controls are independent for each screen window. The markers or limit lines shown in the [measurement result view](#) are measurement performed by the selected screen window. See [Figure 7-9](#).

1. Press [MEAS] key.
2.
  - "Meas Mode > DTF + Return Loss": Displays DTF measurement in the top screen window and the reflection measurement in the bottom screen window
  - "Meas Mode > DTF + TDR": Displays DTF measurement in the top screen window and the time domain reflectometry measurement in the bottom screen window
3. Select the required measurement.  
The R&S ZNH displays the selected measurement combination.
4. Tap on the desired trace window to select the screen window.

The selected screen window is highlighted with a blue frame around the screen window. Alternatively, you can select the trace to identify the screen window.

5. Press [TRACE] key.
6. Select "Select Trace" softkey to toggle between the screen window.  
The selected screen window is highlighted with a blue frame around the screen window.

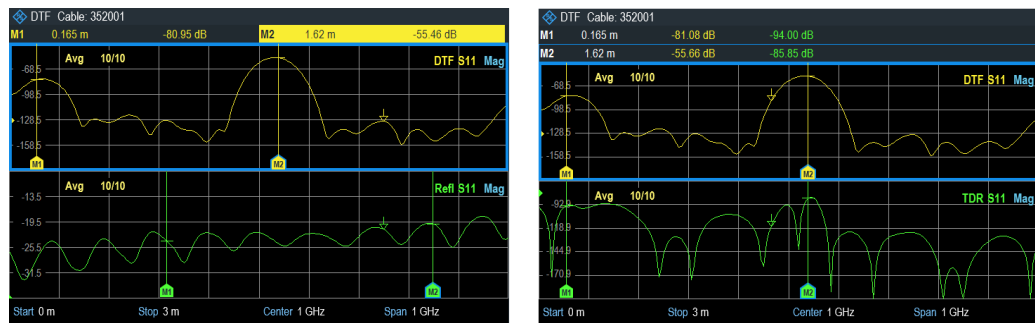

Figure 7-9: Split screen for DTF measurement

### 7.1.6 Time domain reflectometry (TDR)

In addition to the DTF measurement, time domain reflectometry (TDR) measurement is also provided to determine faults (e.g. capacitive or inductive) in a transmission system. Unlike the comprehensive TDA measurement, the TDR measurement is performed with fixed parameters, i.e. **lowpass** mode with **step response** using normal gate windowing for measurement.

The TDR measurement can be performed in the following measurement formats:

- Magnitude (return loss in dB)
- SWR
- Impedance

1. Press [MEAS] key.
2. Select "Meas Mode > TDR" softkey.  
The R&S ZNH perform the time domain reflectometry with default measurement format.



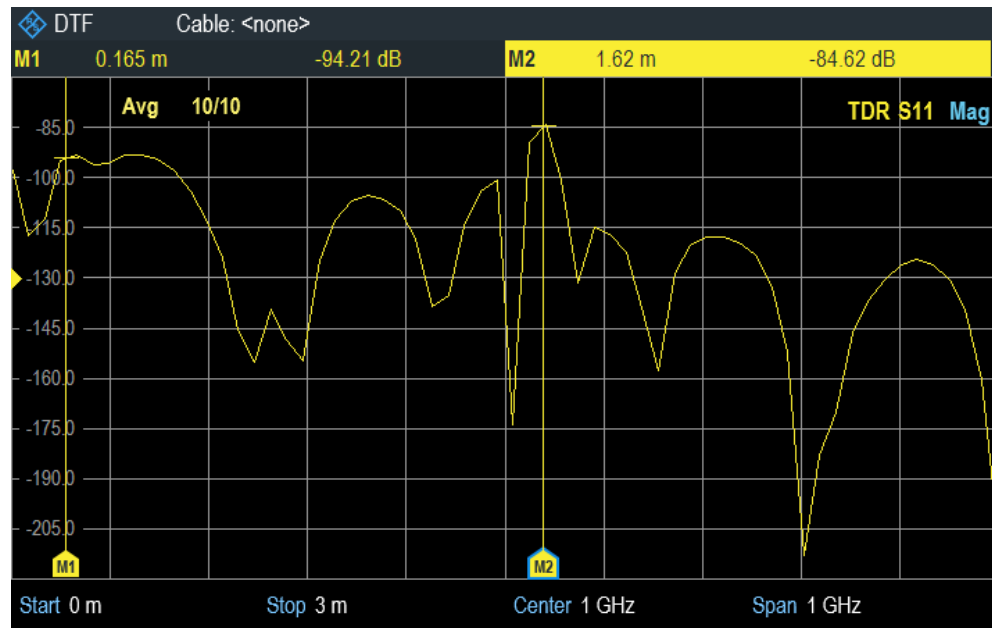

3. To change the measurement format, press [FORMAT] key.
4. Select the required format ("dB Mag", "SWR" or "Impedance") softkey for measurement.

### Split screen

For more information, see ["Split screen"](#) on page 119.

## 7.1.7 Smith chart

The smith chart is a circular diagram that primarily shows the impedance or reflection characteristics of a DUT.

1. Press [MEAS] key.
2. Select "Meas Mode > Return Loss" softkey.  
The R&S ZNH starts the reflection measurement with default measurement format over its entire frequency range.
3. Press [FORMAT] key.
4. Select "Smith" menu item.  
The R&S ZNH shows the reflection of the DUT in smith chart.

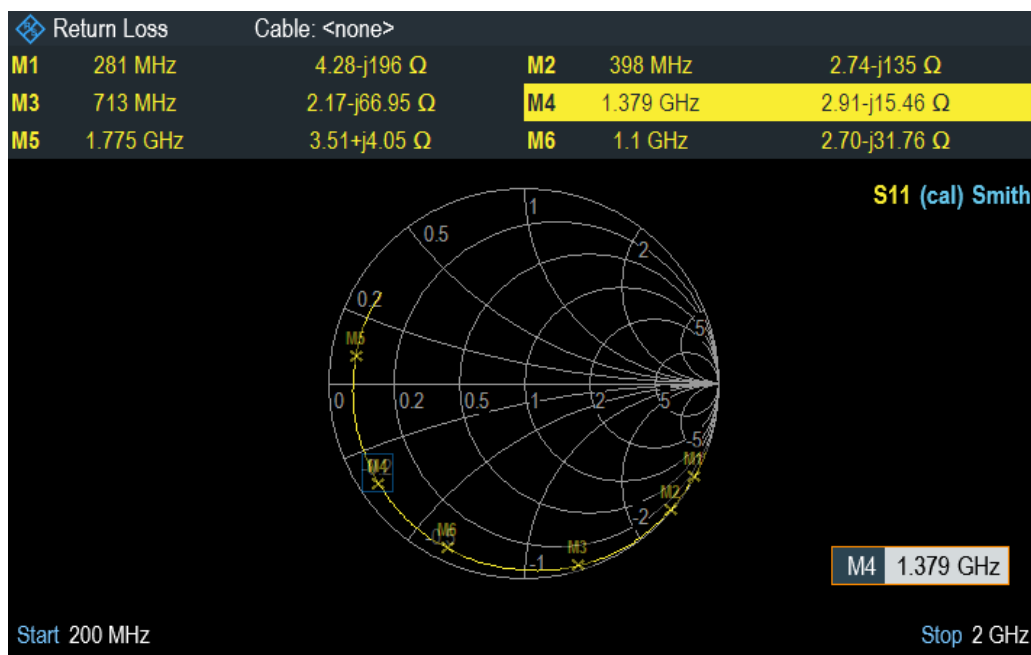

### Using markers

In addition to the standard marker functionality, the following features several extended marker output formats.

**Table 7-1: Extended marker output format**

Marker output format	Descriptions
"Normal"	Shows the marker value in current trace format.
"dB Magnitude + Phase"	Shows the magnitude (in dB) and the phase at the current marker position.
"Lin Magnitude + Phase (Rho)"	Shows the converted magnitude (in %) and the phase (in rho) at the current marker position.
"Real + Imag (Rho)"	Shows the real and imaginary components at the current marker position.
"R + jX"	Shows the real and imaginary components of the impedance at the marker position. The imaginary component is converted to inductance or capacitance. Marker frequency and sign are taken into account.
"G + jB"	Shows the real and imaginary components of the admittance at the marker position. The imaginary component is converted to inductance or capacitance. Marker frequency and sign are taken into account.
"SWR"	Shows the standing wave ratio at current marker position.
"Delay"	Shows the group delay at the current marker position.

- ▶ Press [MARKER] key.  
The R&S ZNH activates a marker and opens the marker softkey menu. Like usual traces, you can move the marker around with the rotary knob or enter a specific marker position.

By default, the marker position is specified by the marker frequency and complex resistance in  $\Omega$ . The complex resistance in that case is calculated according to: (real component) + j (imaginary component).

1. Select "Marker Mode" softkey.  
The R&S ZNH displays the marker mode submenu.
2. Select the marker format that you require.  
The R&S ZNH adjusts the marker information accordingly.  
See ["Using markers"](#) on page 122.

### 7.1.8 Phase measurement

The phase measurement shows the phase characteristics of the DUT in degrees. The diagram is a Cartesian diagram with a linear vertical axis. The horizontal axis represents the measured frequency range.

In the default state, the R&S ZNH shows the phase only from  $-200^\circ$  to  $+200^\circ$ . In that case, the R&S ZNH displays measurement results correctly only if the phase difference between two adjacent test points is less than  $180^\circ$ .

You can unwrap the phase to expand the range of the phase.

1. Press [MEAS] key.
2. Select "Meas Mode > Return Loss" softkey.  
The R&S ZNH starts the reflection measurement with default measurement format over its entire frequency range.
3. Press the [FORMAT] key.
4. Select "Phase" softkey.  
The R&S ZNH performs the phase measurement of the DUT.
5. Select the "Wrap" or "Unwrap" softkey.
6. For additional information display, select either "Electrical Length" or "Delay Time".
  - "Electrical Length" - Enable or disable the check box to display the electrical length of the DUT.
  - "Delay Time" - Enable or disable the check box to display cable delay time.

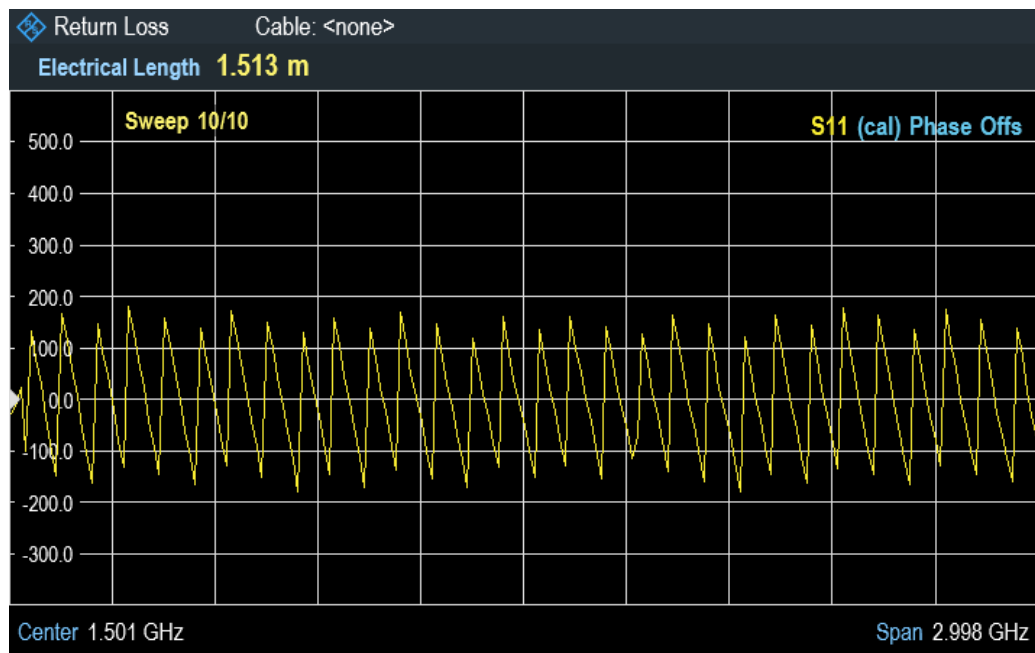

### 7.1.9 Calibrating measurements

In its default state, the R&S ZNH uses factory calibration. Factory calibration is a full 2-port calibration over the full frequency range (i.e. span) of the R&S ZNH. When the factory calibration is active, no calibration status is shown on the trace label. This factory calibration can be overwritten by user calibration, see [Chapter 8.1.3, "Performing calibration"](#), on page 157. In many cases, the factory calibration already provides accurate results.

To get the best and most accurate results, you have to calibrate the measurement. The R&S ZNH provides several calibration methods. You will need one of the available calibration standards such as R&S FSH-Z28 / Z29 (order number. 1300.7810.03 / 1300.7610.03), R&S ZV-Z121 (order no. 1164.0496.02/.03) or [R&S ZN-Z103 \(order number: 3586.9392.00\)](#). For a full list of supported calibration kits, see [Chapter 7.1.9.3, "Calibration kit"](#), on page 128.

Alternatively, you can create customized calibration kits with the functionality of the R&S InstrumentView software package and transfer those to the R&S ZNH.

To successfully calibrate the test setup, you have to connect the calibration standard at the reference plane, usually the output of the RF measurement cable.

The calibration is performed over the R&S ZNH entire frequency range (full span). This full span calibration eliminates the need for recalibration when you change a parameter or select a different cable or DUT. If user calibration is performed, customize frequency span can be performed for the calibration. If you change the frequency parameter after a successful calibration, the [calibration state](#) changes into ("cal", "norm" or "cal int").

Calibration also remains valid after turning off the R&S ZNH or changing into another operating mode as calibration data is saved in the internal memory of the R&S ZNH. If you save the measurement in a dataset, calibration data is part of that dataset. When

you restore the dataset and perform the same measurement again, you do not have to recalibrate the R&S ZNH. See [Chapter 5.4, "Presetting the R&S ZNH"](#), on page 83.

### 7.1.9.1 Calibration states

The R&S ZNH features several calibration states that it displays on the cabin the status line. The possible states depend on the calibration state (see below).

- <no calibration label>  
The R&S ZNH does not display a calibration state when the calibration data uses the factory calibration. The factory calibration is a "Full 2-port" calibration performed in the factory during production. It is stored in the memory and can be restored after a preset.
- (cal)  
The calibration data uses the user calibration. To get in this state, a "Full 1-port" or "Full 2-port" calibration such as "Refl OSM", "TOSM" or "UOSM" is performed.
- (cal int)  
The calibration data uses the interpolated user calibration after a "Full 1-port" or "Full 2-port" is performed. Interpolation is used when you change one of the frequency parameters (start, stop or center frequency). In that case, the distribution of the measurement points is different to the distribution during calibration. This could result in an increasing measurement uncertainty.
- (norm)  
The R&S ZNH is using normalization. To get in this state, the normalization type of calibration is performed, such as "Refl Norm Open", "Refl Norm Short", "Refl Norm P1", "Refl Norm P2" or "Normalization Both". For more information, see [Chapter 8.1.2, "Calibration methods"](#), on page 156.
- (uncal)  
No calibration is loaded. The R&S ZNH is in this state during the calibration process.

### 7.1.9.2 Calibration methods

The following user calibration methods are available in the antenna and cable test mode.

- Full 2-Port ("TOSM", "UOSM" and "TRL")  
Both RF ports are calibrated for a complete set of measurements. Depending on the calibration methods used, the following calibration routine applies:
  - "TOSM", "UOSM"  
The calibration routine requires the connection of the standards load, open and short to both test ports, and a through connection of the RF ports.
  - "TRL"  
The calibration routine requires the connection of the reflection standard to both test ports, a through and a line connection of the RF ports.

The influences of the test setup and of the isolation between the RF ports are thereby determined and taken into account in the subsequent measurement of the device under test.

While this method is the most time-consuming during calibration, it does provides the greatest accuracy for all measurements at both test ports without recalibration and is thus the most flexible. For more information on "TOSM", "UOSM" and "TRL", [Chapter 8.1.2, "Calibration methods"](#), on page 156.

- Full 1-Port ("Refl OSM")  
RF input port is calibrated for measurements on that port. The calibration routine requires the calibration standards open, short and load to be connected one after another.  
For more information on "Refl OSM", see [Chapter 8.1.2, "Calibration methods"](#), on page 156.
- One port normalize ("Refl Norm Open" and "Refl Norm Short")  
RF input port is calibrated for measurement on that port. The calibration procedure requires no calibration standards for "Refl Norm Open" calibration as the R&S ZNH calibrates an open connection only. See [Chapter 8.1.2, "Calibration methods"](#), on page 156 for more information on "Refl Norm Open" and "Refl Norm Short".
- Normalize Trans ("Trans Norm P1", "Trans Norm P2" and "Trans Norm Both")  
Both RF ports are calibrated for transmission measurements. The calibration routine requires only a Through connection. In the subsequent measurement, the isolation between the test ports is not taken into account, a possible cross-talk between the test ports in the test setup is not eliminated.  
See [Chapter 8.1.2, "Calibration methods"](#), on page 156 for more information on "Trans Norm P1", "Trans Norm P2" and "Trans Norm Both".

### User calibration

After a user calibration is performed, the R&S ZNH allows you the option to apply user calibration ("cal" or "norm") or resume factory calibration data on the measurement.

1. Press the [CAL] key.
2. Select the "User Calibration" softkey.  
Depending on the current calibration state, the R&S ZNH toggles between the user calibration and factory calibration state.  
Note: The [calibration state](#) is displayed as part of the [trace label](#) at the top right-hand corner of the trace window.

### Calibration unit, R&S ZN-Z103

Equipped with the calibration kit, R&S ZN-Z103, you can perform an automatic "Full 1-Port" calibration across the entire frequency range. Unlike the manual calibration, this calibration unit performs the calibration standard open, short and load to RF input of the R&S ZNH without making any connection change during the calibration procedure.

Detection of the calibration kit is by means of the USB interface connection to the R&S ZNH. See [Figure 7-11](#).

When the calibration kit is detected, the R&S ZNH displayed the information in the [Figure 7-10](#).



Figure 7-10: Calibration kit information on title bar

1. Press the [CAL] key.  
The R&S ZNH displayed the message "Calibration unit detected".

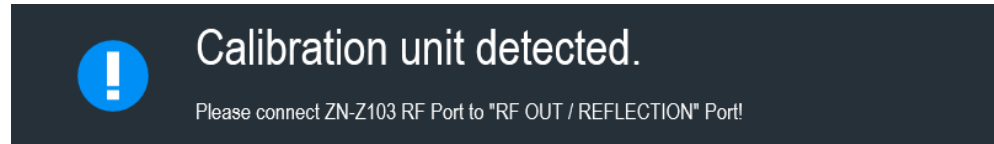

2. Connect the calibration kit, R&S ZN-Z103 to "RF OUT/ REFLECTION" port of the R&S ZNH.
3. Select "Continue" to start the calibration.  
The R&S ZNH performs the full 1-port calibration for a "Short", "Open" or a "Load" connection automatically.

When the calibration routine is completed, the R&S ZNH displays the message "Calibration done!".

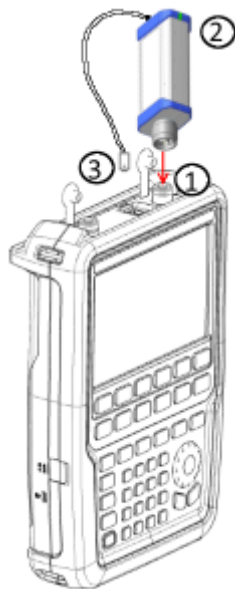

Figure 7-11: Calibration kit, R&S ZN-Z103

- 1 = RF input
- 2 = Calibration kit, R&S ZN-Z103
- 3 = USB interface of calibration kit, R&S ZN-Z103

### 7.1.9.3 Calibration kit



When calibration unit [R&S ZN-Z103](#) is used for the calibration procedure, its calibration model will supersede the calibration kit model selected.

The calibration kit model provides the "Open", "Short", and "Load" parameters that are to be taken into consideration when performing a calibration with the corresponding calibration kit. The R&S ZNH supports the following calibration models:

- R&S FSH-Z28
- R&S FSH-Z29
- R&S ZN-Z229
- R&S ZN-Z270
- R&S ZCAN
- R&S ZV-Z121 Male / Female
- R&S ZV-Z132 Male / Female
- R&S ZV-Z135 Male / Female
- R&S ZV-Z170 Male / Female

Alternatively, you can create customized calibration kits with the functionality of R&S InstrumentView software package and use them on the R&S ZNH. For more information, see the documentation of the R&S InstrumentView software package. See also [Chapter 4.2.8, "Configuring calibration kit model"](#), on page 50.

### 7.1.9.4 Performing a full 2-Port calibration



#### Cancel calibration

You can abort the calibration any time by pressing the "Cancel" softkey.



#### Full 1-Port calibration

The full 1-Port calibration is similar to full 2-Port calibration, except that "THROUGH" calibration is not performed.



#### R&S ZN-Z103

Using calibration unit [R&S ZN-Z103](#), auto calibration is performed for the open, short and load calibration standards followed by a manual connection of through cable for the through calibration standard.

The calibration routine in CAT performs mode is the same as VNA mode.

For details on performing a full 2-port calibration, see [Chapter 8.1.3, "Performing calibration"](#), on page 157.



## 7.2 Configuring cable and antenna tests

For valid measurement results, you need to specify the characteristics of the cable under test like cable model or the frequency usage range.

### 7.2.1 Selecting the cable mode

To determine the speed of propagation, and therefore the precise distance to any faults, you have to specify the cable model that you want to test.

The R&S ZNH already comes with an assortment of predefined cable models that you can use without doing anything. If you want to test a cable that is not listed, you can also define cable models manually, either directly on the R&S ZNH or with the "Cable Model Editor" of the R&S InstrumentView software package that is delivered with the R&S ZNH.

For more information of the "Cable Model Editor", see R&S InstrumentView user manual.

#### 7.2.1.1 Selecting a predefined cable model

1. Press [MEAS] key.
2. Select "Meas Mode > DTF" or "Meas Mode > TDR" softkey for the respective measurement type.  
The R&S ZNH displays the DTF/TDR configuration submenu.
3. Select the "Cable Config" softkey.  
The R&S ZNH opens a submenu to select the cable model.
4. Select the "Cable Model" menu item.  
The R&S ZNH opens the file manager to select a cable model.

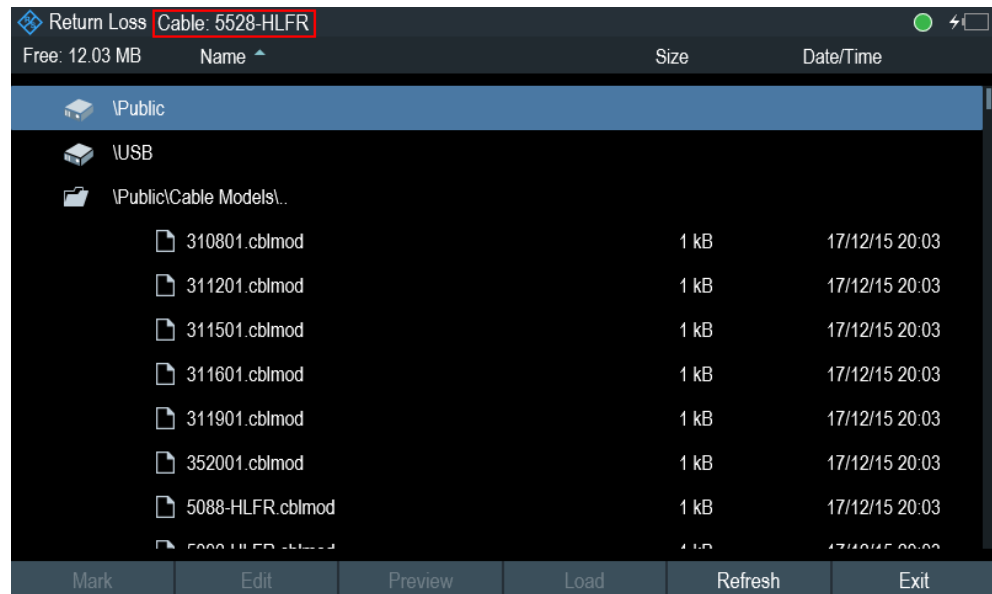

- Select the cable model that you are testing.  
The R&S ZNH loads the selected cable model. Note that the selected cable model is also displayed in the [title bar](#).

### 7.2.1.2 Clear cable model

- Press [MEAS] key.
- Select "Meas Mode > DTF" or "Meas Mode > TDR" softkey for the respective measurement type.  
The R&S ZNH displays the DTF/TDR configuration submenu.
- Select the "Cable Config" softkey.  
The R&S ZNH opens a submenu to select the cable model.
- Select the "Clear Model" softkey.  
The R&S ZNH unloads the cable model from the measurement.

### 7.2.1.3 Creating a cable model



#### Temporary cable model

When you change any cable parameters or load another cable model, the temporary cable model data is lost and you have to define it again if you have to perform further measurements.

The R&S ZNH provides two ways to define customized cable models.

The first way is to define a cable model with the "Cable Model Editor" that is part of the R&S InstrumentView software package. The R&S InstrumentView is delivered with the

R&S ZNH. With this software, you can define a cable model on a computer and then transfer it to the instrument.

For more information, see [Chapter 5.8, "Managing datasets"](#), on page 87.

If you do not have access to a computer, but still need a cable model that is not stored on the R&S ZNH, you can also define the characteristics of a cable temporarily on the R&S ZNH itself. It is not possible to save these cable characteristics in a dataset, they are lost when you change them or load another cable model.

1. Press [MEAS] key.
2. Select "Meas Mode > DTF" or "Meas Mode > TDR" softkey for the respective measurement type.  
The R&S ZNH displays the DTF/TDR configuration submenu.
3. Select the "Cable Config" softkey.  
The R&S ZNH opens a submenu to select the cable model.
4. Select the "User Settings" menu item.  
The R&S ZNH opens a submenu to specify the user settings for the cable model.
5. Select the "Frequency" menu item.  
The R&S ZNH opens an input field to specify the frequency.
6. Enter the frequency of the cable that you are measuring.
7. Repeat from step 3 to configure the settings for the cable velocity and cable loss.  
You can now perform measurements using the temporary cable definition.  
See ["Temporary cable model"](#) on page 130.

After you have defined the cable characteristics, you still have to activate the use of the customized cable.

1. Select the "Cable Config" softkey.  
The R&S ZNH opens a submenu to select the cable model.
2. Enable the checkbox to turn on the "User Model" menu item.  
The R&S ZNH uses the customized cable model.

#### 7.2.1.4 Working with a DTF list



"DTF/TDR List" and "List Threshold" are only available in the distance to fault (DTF) measurement.

The DTF list shows the results of the distance to fault measurement in numerical form.

1. Press [MEAS] key.
2. Select "Meas Mode > DTF" or "Meas Mode > TDR" softkey for the respective measurement type.

The R&S ZNH displays the DTF/TDR configuration submenu.

3. Select the "DTF/TDR List" softkey.  
The R&S ZNH opens a table that lists the peaks it has found during the measurement.

Peak ①	Distance ②	Return Loss ③
1	13.87 m	-42.78 dB
2	13.92 m	-42.11 dB
3	13.99 m	-41.73 dB
4	14.2 m	-14.11 dB
5	14.4 m	-41.83 dB
6	14.45 m	-42.13 dB
7	14.51 m	-42.10 dB

Threshold -43.00 dB

1 = Shows the peak results

2 = Shows the distance from the measurement plane to the peak.

3 = Shows the magnitude of the peak.

To limit the information in the list, you can define a new threshold level for the DTF list, so that only the peaks above a certain level are included in the list.

1. Press [MEAS] key.
2. Select "Meas Mode > DTF" or "Meas Mode > TDR" softkey for the respective measurement type.  
The R&S ZNH displays the DTF/TDR configuration submenu.
3. Select the "List Threshold" softkey.  
The R&S ZNH opens a submenu to specify the threshold in dB.
4. Enter the threshold that you require.  
The R&S ZNH now only shows the peaks that are above the level you have entered.

## 7.2.2 Configuring the horizontal axis

The [FREQ/DIST] key contains all necessary functions to define the frequency and distance parameters when performing cable measurements. The contents of the menu depend on the currently selected measurement.



### Dedicated DTF frequency

The "Dedicated DTF Frequency" menu item defines whether the frequency "(DTF Start Freq", "DTF Stop Freq", "DTF Center Freq", "DTF Span") settings in DTF measurement are coupled to frequency ("Start", "Stop", "Center", "Span") settings in other measurements in CAT mode. When set "Off", the frequency (start, stop, span) settings are coupled across all measurements in CAT mode.

See ["Setting a dedicated DTF frequency"](#) on page 134.

#### 7.2.2.1 Setting the frequency range for DTF measurements

In the default settings, the R&S ZNH automatically selects a center frequency of 1 GHz and a distance of 50 m. The R&S ZNH optimizes the settings for the best resolution, if you change the stop distance.

If you have to keep the current frequency settings, it is best to define a manual span.

#### Setting the frequency span

When setting the frequency range, it is best to set the span first follow by the center frequency.

There are four different span modes in the DTF measurement:

- Manual  
Setting for span is defined manually.
- Auto Span  
The best span is automatically calculated for the best length resolution.
- Auto Points  
The best number of points is automatically calculated for the best length resolution for the frequency setting.
- Coupled  
The frequency parameters are coupled with the [Return Loss](#) measurement, with the maximum cable distance adjusted for the best resolution. This mode is useful when you switch between the [Return Loss](#) and [DTF](#) measurements.

1. Press the [FREQ/DIST] key.
2. Select the "DTF Span" softkey.  
The R&S ZNH opens a submenu to specify the frequency span.  
By default, the R&S ZNH automatically calculates the best span ("Auto Span") for the best length resolution. If the required span is too large for the current center frequency, the R&S ZNH sets the center frequency to the smallest possible frequency.
3. Select the "Manual Span" menu item.  
The R&S ZNH opens an input field to specify the frequency span.
4. Enter the span that you require.  
The R&S ZNH sets the new span.

Note1: For "Auto Span", the maximum span you can set depends on the maximum cable distance you have defined and is never greater than the span calculated by the "Auto Span" function.

Note2: For "Auto Points", the number of points is adjusted to give you the best length resolution for a cable distance and frequency setting. However, the increase of length resolution results in a longer of sweep time in measurement.

The minimum span that you can set is 10 MHz.

### Setting the displayed frequency range

After you have selected the span, you can set a particular frequency range which results the R&S ZNH displays.

In the default settings, the R&S ZNH adjusts the "DTF start" and "DTF stop" frequency according to the span and the center frequency. The distance from center frequency to the start and stop frequency is the same. Alternatively, you can directly set a "DTF start" and "DTF stop" frequency.

1. Press the [FREQ/DIST] key.
2. Select the "DTF Center Freq" softkey.  
The R&S ZNH opens an input field to specify the center frequency.
3. Enter the center frequency that you require.  
The R&S ZNH adjusts the frequency range according to span and center frequency.
4. Select the "DTF Start Freq" or the "DTF Stop Freq" softkey.  
The R&S ZNH opens an input field to specify the start frequency or stop frequency.
5. Enter the start frequency or stop frequency you require.  
The R&S ZNH adjusts the frequency range according to your settings.  
Note that the distance from start to stop frequency has to be equal to the span. The R&S ZNH adjusts the values if you enter a frequency range that is not the same as the span.

### Setting a dedicated DTF frequency

You can set a dedicated DTF frequency to be used in the DTF measurement. With this setting, the DTF frequency remains unchange when there is a frequency change in other measurements in the CAT mode.

1. Press the [SETUP] key.
2. Select the "User Preference" softkey.
3. Select the "Dedicated DTF Frequency" item.  
A drop- down menu opens to select the dedicated DTF frequency setting.
4. Select "On" to set a dedicated DTF frequency.  
See "[Dedicated DTF frequency](#)" on page 133.

### 7.2.2.2 Setting the start and stop distance for DTF measurements

The start and stop distance define the scaling of the horizontal axis.

In the default setting, the horizontal axis start at 0 m and covers the maximum or stop distance you have set. By adjusting the start and stop distance, you can zoom in to a particular section of the cable for further analysis.

1. Press the [FREQ/DIST] key.
2. Select the "Start Dist" or "Stop Dist" softkey.  
The R&S ZNH opens an input field to specify the start distance or stop distance.
3. Enter the distance that you want the display to start from and to end at.  
In auto span mode, the R&S ZNH adjusts the frequency settings in order to get the best display resolution.  
If you have set the span manually, the R&S ZNH zooms in to the section of the cable you have defined. The results maintain their accuracy in that case.

### 7.2.2.3 Setting the frequency range for CAT measurements (except DTF)

For measurement on reflection, transmission or cable loss, the displayed frequency range is defined by the span, the center frequency or start and stop frequencies.

#### Defining the span

The span you should select depends on the frequency band you are analyzing and the frequency range you need information about.

1. Press the [FREQ/DIST] key.
2. Select the "Span" softkey.  
The R&S ZNH opens an input field to specify the frequency span.
3. Enter the span that you require.  
The R&S ZNH sets the span that you have entered.

#### Setting the displayed frequency range

In the default settings, the R&S ZNH adjusts the start and stop frequency according to the span and the center frequency, with the center frequency being in the middle of the horizontal axis. Alternatively, you can directly set the start and stop frequency.

1. Press the [FREQ/DIST] key.
2. Select the "Center" softkey.  
The R&S ZNH opens an input field to specify the center frequency.
3. Enter the center frequency that you require.  
Alternatively, set the frequency range independent of span and center frequency.
4. Select the "Start" or "Stop" softkey.

The R&S ZNH opens an input field to specify the frequency.

5. Enter the frequency that you require.

#### 7.2.2.4 Selecting a signal standard for CAT measurements (except DTF)

When you perform the reflection, cable loss, smith chart or phase measurement, the R&S ZNH provides several configurations for measurements on a particular signal standard. When you select one of these standards, the R&S ZNH loads the corresponding parameters like center frequency or span.

1. Press the [FREQ/DIST] key.
2. Select the "Signal Standard" softkey.  
The R&S ZNH opens a submenu to select the signal standard.
3. Select either the "Select Uplink" or "Select Downlink" menu items.  
The R&S ZNH opens the file manager to select the signal standard.
4. Select the standard you require.  
The R&S ZNH load the settings of the standard you selected.

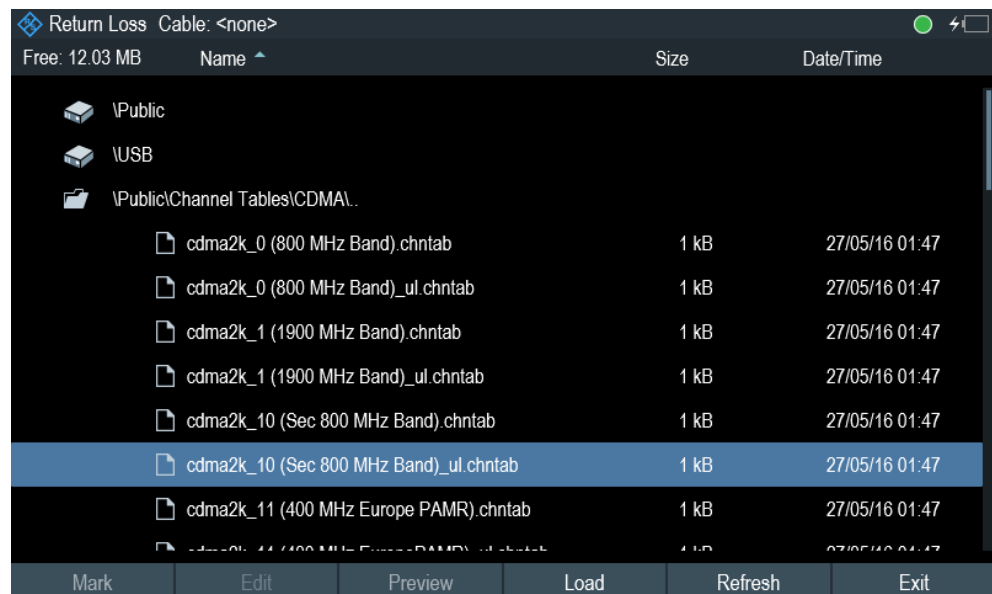

### 7.2.3 Configuring the vertical axis

The [SCALE/AMPT] key contains menu on settings related to the level display.

#### 7.2.3.1 Setting the reference value

The reference value defines the amplitude of the reference line. The R&S ZNH indicates the position of the reference value with a triangle  at the vertical axis.



When you change the reference value, the R&S ZNH adjusts the labels of the vertical axis. Changing the reference value results a change in the vertical position of the trace. It does not change the position of the reference line.

1. Press the [SCALE/AMPT] key.
2. Select the "Ref" softkey.  
The R&S ZNH opens an input field to specify the reference level.
3. Enter the reference level that you require or move the reference level with rotary knob.  
The R&S ZNH sets up the display accordingly.

#### 7.2.3.2 Defining the display range

The display range defines the scale of the vertical axis and therefore the amplitude between the two horizontal grid lines. The unit depends on the measurement format.

When you change the display range, you can increase or decrease the amplitude the R&S ZNH displays and, e.g. include signal parts that are outside the displayed screen area. The position of the reference value and the trace does not change.

1. Press the [SCALE/AMPT] key.
2. Select the "Range" softkey.  
The R&S ZNH opens an input field to specify the range setting.
3. Enter the range that you require.  
The R&S ZNH adjust the vertical axis accordingly.

#### 7.2.3.3 Adjusting the vertical axis automatically

The R&S ZNH provides an automatic scaling algorithm to optimize the results display. The R&S ZNH does this by determining the minimum and maximum trace values and adjust the vertical axis according to these values.

1. Press the [SCALE/AMPT] key.
2. Select the "Auto Scale" softkey.  
The R&S ZNH performs the automatic adjustment of the vertical axis.

#### 7.2.3.4 Setting the reference position

The reference position defines the position of the reference line in the diagram. The reference position is a linear value between "0" and "10". Each value represents one horizontal grid line of the diagram. The "0" value corresponds to the top grid line and the "10" corresponds to the bottom grid line.

When you change the reference position, the R&S ZNH also shifts the position of the trace by the magnitude of the reference position change. It has no effect on the reference value itself.

1. Press the [SCALE/AMPT] key.
2. Select the "Ref Position" menu item.  
The R&S ZNH opens an input field to specify the reference position.
3. Enter the reference position that you require.  
The R&S ZNH moves the trace accordingly.

#### 7.2.3.5 Setting the attenuation

The R&S ZNH provides functions to attenuate the signal at the RF input.

1. Press the [SCALE/AMPT] key.
2. Select the "Receiver Att" softkey.  
The R&S ZNH opens an input field to specify the attenuation level.
3. Enter the attenuation of the signal at the RF input.  
You can set an RF attenuation in the range from 0 dB to 30 dB in 5 dB steps.

#### 7.2.4 Configuring the tracking generator



##### Tracking generator output level

Using an output level of 0 dBm (or a receiver attenuation of 0 dB) for S12 or S21 measurements can cause an overload at the RF input. It is therefore recommended to use an output level of -10 dBm (default) or lower for these measurements. This especially applies to measurements on amplifiers.

1. Press the [SCALE/AMPT] key.
2. Select the "Port Config" softkey.  
The R&S ZNH opens a submenu to configure port settings.
3. Select the "Port Power" menu item.  
The R&S ZNH opens an input field to specify the output level.
4. Enter the desired output level of the signal in dBm.

#### 7.2.5 Setting the measurement bandwidth

The measurement bandwidth determines the noise figure of the receiver. Small bandwidths result in higher measurement dynamics for S21 measurements. However, small bandwidths cause longer measurement times because of the settling time of the filter.

Possible bandwidths are between 10 Hz and 100 kHz in a 1-3 sequences.

1. Press [SWEEP] key.

2. Select the "Meas BW" softkey.  
The R&S ZNH opens an input field to specify the measurement bandwidth.
3. Enter the measurement bandwidth that you require.  
As an indicator that the "Meas BW" is no longer coupled to the span, the R&S ZNH displays a blue dot in front of the "Meas BW" item in the parameter view.

## 7.2.6 Setting the measurement sweep

The [SWEEP] key provides menu to control the response on how the measurement results are presented.

### 7.2.6.1 Selecting the sweep mode

The sweep mode is the way the R&S ZNH performs the measurement.

In its default state, the R&S ZNH measures continuously. In this mode, the R&S ZNH automatically repeats the sweep in the defined range of the horizontal axis and updates the trace accordingly after it has finished with one sweep.

Single sweep mode performs the sweep in the defined span once, then the R&S ZNH goes into an idle state. If the trace averaging is set, the R&S ZNH performs the sweep a certain number of times (depending on the number of averages you have set) over the defined span and then stops measuring.

1. Press the [SWEEP] key.
2. Select the "Single Sweep" or "Continuous Sweep" softkey.  
The R&S ZNH performs the sweep respectively.

For more information on trace setting, see [Chapter 7.3.1, "Working with traces"](#), on page 140.

### 7.2.6.2 Changing the number of measurement points

The number of (measurement) points defines the number of measurements performed during a sweep. Thus, it indirectly sets the frequencies of those measurements. The distance from one measurement point to the next depends on the currently set frequency range (span divided by number of points). However, the measurement points are spread evenly over the selected frequency range.

The number of points also defines the resolution and, therefore, the accuracy of the measurement and affects the measurement time. In the default state, the R&S ZNH evaluates 201 measurement points. This number allows for fast measurement times and sufficient accuracy. For measurements with a higher or lower frequency resolution, you can change the number of measurement points. Note that measurement times increase if you set a higher number of measurement points.

1. Press the [SWEEP] key.

2. Select the "Points" softkey.  
The R&S ZNH opens an input field to specify the number of measurement points. Up to 16001 measurement points is possible for measurement.
3. Enter the number of measurement points that you require.  
The R&S ZNH sets the number of measurement points used for the measurement.

### 7.2.6.3 Measurements hold

The R&S ZNH provides a hold function that stops the display update and leaves room for further analysis of the measurement results.

1. Press the [SWEEP] key.
2. Select the "Hold" softkey.  
The R&S ZNH interrupt the display update.  
To resume the display update, select the "Hold" softkey again.

## 7.3 Analyzing measurement results

### 7.3.1 Working with traces

The R&S ZNH provides several trace modes. The trace mode defines the way the R&S ZNH writes the trace.

For more information on the sweep mode, see [Chapter 7.2.6.1, "Selecting the sweep mode"](#), on page 139.

#### 7.3.1.1 Setting the trace mode

There are two ways how the R&S ZNH write the trace:

- "Average Off"  
This is the default trace mode. In this mode, the trace is overwritten after each sweep.
- "Average On"  
In this mode, the trace is the result of the moving average over several sweeps. You can define the number of sweeps to be (moving) averaged.

1. Press the [TRACE] key.
2. Select the "Trace Mode" softkey.  
The R&S ZNH opens a submenu to select the trace mode.
3. Select "Average Off" or "Average On" menu item.

### 7.3.1.2 Suppressing interfering signals

When performing measurements in the field, you may encounter interfering signals from surrounding signal sources like other antennas. These signals could distort the actual measurement and therefore lead to false assumptions about faults in the system you are measuring.

The R&S ZNH provides a method to suppress signals resulting from interfering sources without affecting the accuracy of the actual measurement.

1. Press the [TRACE] key.
2. Select the "Smoothing" softkey.  
The R&S ZNH opens a submenu to select the trace mode.
3. Select the "Smoothing On" menu item.  
When the suppression of interference is activated, the menu item for aperture setting is available.
4. By default the "Aperture Auto" is used. To set it manually, select "Aperture Manual" menu item.  
The R&S ZNH turns automatic aperture calculation off and opens an input field to specify the aperture setting.
5. Set the aperture size according to your measurement.

When suppression of interference is activated, the R&S ZNH looks for signals that interfere with the measurement and suppresses them in the result display. Faults in the system you are measuring, however, still displayed correctly.

### 7.3.1.3 Working with memory traces

The R&S ZNH can transfer a trace to the trace memory and also display the current trace and the trace in the trace memory for comparison. The saved trace is always displayed in a lighter yellow to distinguish it from the current trace. See [Figure 7-12](#).

1. Press the [TRACE] key.
2. Select the "Trace ►Memory" softkey.  
The R&S ZNH transfers the trace to the trace memory.
3. Select the "Show Memory" softkey.  
The R&S ZNH displays the saved trace in lighter color.

You can remove the memory trace by pressing the "Show Memory" softkey again.

The memory traces are bit-mapped into the picture memory. Therefore, when the memory trace is recalled, it will not be adapted to any modifications of the reference level or span that may have been made in the meantime.

When you load a dataset, the R&S ZNH stores the corresponding trace in the trace memory. You can view that trace with the "Show Memory" softkey.

### 7.3.1.4 Using trace mathematics

Trace mathematics subtract the memory trace from the live trace and vice versa and then display the results. After you transfer a trace to the trace memory, you can perform the trace mathematics function.

1. Press the [TRACE] key.
2. Select the "Trace Math" softkey.  
The R&S ZNH opens a submenu to select the trace math operation.
3. Select the "Trace - Memory" or "Memory / Trace" menu item.  
The R&S ZNH calculates and shows the resulting trace.
4. To turn off trace mathematics, select the "Off" menu item.

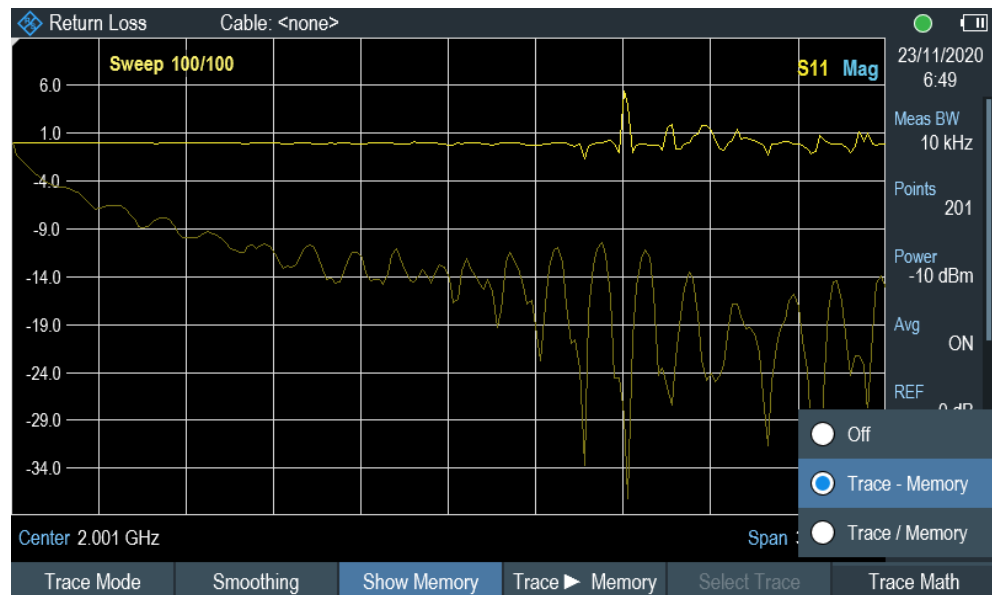

Figure 7-12: Trace memory

## 7.3.2 Using markers

The [Measurement result view](#) shows the horizontal position of all markers and the corresponding vertical value.

You can select any marker in the [Measurement result view](#) for further marker function using the marker softkey menu.

### 7.3.2.1 Using markers and deltamarkers

The R&S ZNH has six markers, five of which can be used as either markers or delta markers.

The markers cannot leave the trace and indicate the horizontal and vertical coordinates of the point they are positioned on. The horizontal position of a marker is shown by a vertical line which extends from the top to the bottom of the measurement diagram. The marker list above the diagram area shows the exact coordinates of all markers in use.

The position of a delta marker is indicated by a dashed line to distinguish it from a normal marker. The delta marker level is always a relative to the main marker level and so the delta marker level unit is always dB. The delta marker frequency is always relative to the main marker – in other words, the delta marker frequency is the frequency difference between the frequency at the point marked by the main marker and the frequency at the point marked by the delta marker.

To measure complex signals, you can activate up to six markers. Marker 1 is always a normal marker and the reference of all delta markers. Markers 2 to 6 are either markers or delta markers depending on your setup.

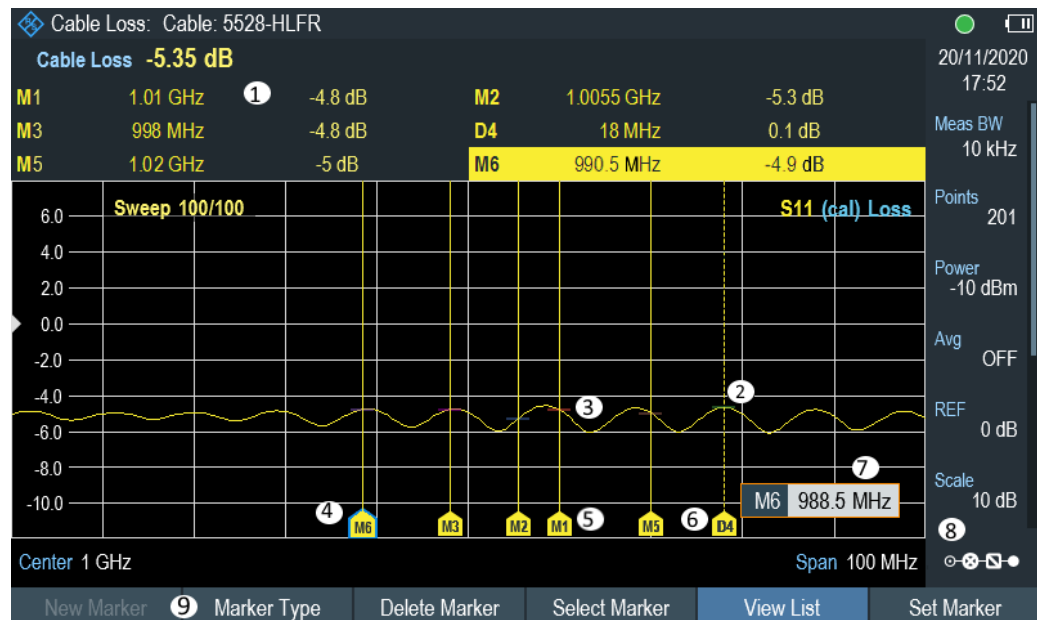

Figure 7-13: Screen layout with active markers

- 1 = [Measurement result view](#)
- 2 = Delta marker (dotted line)
- 3 = Marker (solid line)
- 4 = Active marker label (see highlighted line on the marker list as well as the marker label )
- 5 = Marker label: M(x)
- 6 = Delta marker label: D(x)
- 7 = Marker input field
- 8 = [Parameter view](#)
- 9 = Marker menu

## Positioning markers



### Special touchscreen gesture

Double tap on the touchscreen to position new marker on the trace window. The first marker that is positioned on the trace window is always the main marker, the following markers added on the trace window are the delta markers.

Tab and drag on the marker icon to change the marker position.

See [Chapter 5.1.4, "Add marker"](#), on page 74 and [Chapter 5.1.5, "Move marker"](#), on page 74.

1. Press the [MARKER] key.  
If no marker has been activated, the R&S ZNH automatically activates the main marker and positions it on the maximum level that has been measured. In addition, the marker frequency input field opens.  
You can perform the following actions:
  - Tab and drag on the marker icon to change the marker position.
  - Position the marker with the rotary knob  
When positioning the marker with the rotary knob, the step size is one pixel.
  - Enter a marker position with the number keys and confirm the entry with one of the unit keys.
2. Confirm the marker position by pressing the rotary knob.  
The marker input field closes.

## Positioning a delta marker

When a normal marker is already in use, you can add delta markers.



### Special touchscreen gesture

Double tap on the touchscreen to position the delta marker on the trace window.

See [Chapter 5.1.4, "Add marker"](#), on page 74.

1. Press the [MARKER] key.
2. Select the "New Marker" softkey.  
The R&S ZNH activates a delta marker and positions it on the next maximum level that has been measured. In addition, the delta marker input field opens.  
The R&S ZNH adds the delta marker to the marker list and shows the marker position relative to the normal marker (M1).  
You can perform the following actions:
  - Enter a delta marker position with the number keys and confirm the entry with one of the unit keys.
  - Change the delta marker position with the rotary knob.
3. Confirm the delta marker position by pressing the rotary knob.  
The delta marker input field closes.



4. To add more markers, press the "New Marker" softkey several times until you have the number of markers you want in the display.

### Selecting the marker type

When you add new markers, they are delta markers by default. Their coordinates are relative to the first marker (M1). You can turn delta markers into normal markers if you need absolute information about the marker position.

1. Press the [MARKER] key.
2. Select the delta marker you want to convert in the [Measurement result view](#).  
Alternatively, select the "Select Marker" softkey to select the delta marker you want to convert.
3. Select the "Marker Type" softkey.  
The delta marker turns into a normal marker. Its label changes accordingly (e.g. D2 to M2) and its coordinates are now absolute values.

### Automatic positioning of markers

The R&S ZNH offers functions that make setting the markers easier or allow to make instrument settings on the basis of the current marker position:

1. Press the [MARKER] key.
2. Select the affected marker in the [Measurement result view](#).  
Alternatively, select the "Select Marker" softkey to select the affected marker.
3. Select the "Set Marker" softkey.  
The R&S ZNH opens a submenu to select the marker automatic positioning settings.
4. Select the marker automatic position that you require.  
The R&S ZNH positions the marker accordingly.

The R&S ZNH provides the following selections for automatic positioning of markers:

- "Set To Peak"  
The peak function places the active marker or the delta marker on the highest level value of the trace.
- "Set To Next Peak"  
The next peak function places the active marker or delta marker on the next highest level value of the trace, relative to its current position.
- "Set To Minimum"  
The minimum function places the active marker or delta marker on the lowest value of the trace.
- "All Marker To Peak"  
This function place all the active markers to the peak values of the trace.
- "Search Range"  
See ["Using marker search limits"](#) on page 146.

### Removing markers

Remove markers any time you want from the trace window.

### Removing selected markers



#### Deactivating markers

If you delete main marker ("M1"), all delta markers that are relative to that marker are also deleted.

1. Select the marker you want to delete in the [Measurement result view](#).  
Alternatively, select the "Select Marker" softkey to select the marker you want to delete.
2. Select the "Delete Marker" softkey.  
The R&S ZNH opens a submenu to select the marker deletion.
3. Select the "Delete Selected" menu item.  
The R&S ZNH deletes the marker.

### Removing delta markers only

1. Press the [MARKER] key.
2. Select the "Delete Marker" softkey.  
The R&S ZNH opens a submenu to select the marker deletion.
3. Select the "Delete All Delta" menu item.  
The R&S ZNH deletes all delta markers.

### Removing all markers at the same time.



#### Special touchscreen gesture

Draw an "X" on the trace window to delete all markers and delta markers on the trace window.

See [Chapter 5.1.6, "Delete all markers"](#), on page 75.

1. Press the [MARKER] key.
2. Select the "Delete Marker" softkey.  
The R&S ZNH opens a submenu to select the marker deletion.
3. Select the "Delete All" menu item.  
The R&S ZNH deletes all markers and delta markers.

### Using marker search limits

The R&S ZNH allows you to use only a limited section of the trace for the marker automatic positioning functions. See ["Automatic positioning of markers"](#) on page 145. The R&S ZNH provides setting to define two search range limits.

1. Press the [MARKER] key.
2. Select the "Set Marker" softkey.  
The R&S ZNH opens a submenu to select the marker positioning.
3. Select the "Search Range" menu item.  
The R&S ZNH opens the marker search limits softkey menu.
4. Select "Search Range 1" or "Search Range 2" softkey to define the two search range limit respectively.  
The R&S ZNH opens a submenu to define the lower and upper limit of the search range.
5. Select the "Lower Limit" menu item.  
The R&S ZNH opens an input field to define the lower limit.
6. Enter the limit you require.
7. Confirm the entry with one of the unit keys.  
If the span is wide enough, the R&S ZNH displays a blue and green line to indicate the limit line for "Search Range 1" and "Search Range 2" respectively. By default, the search limit range is over the whole span.

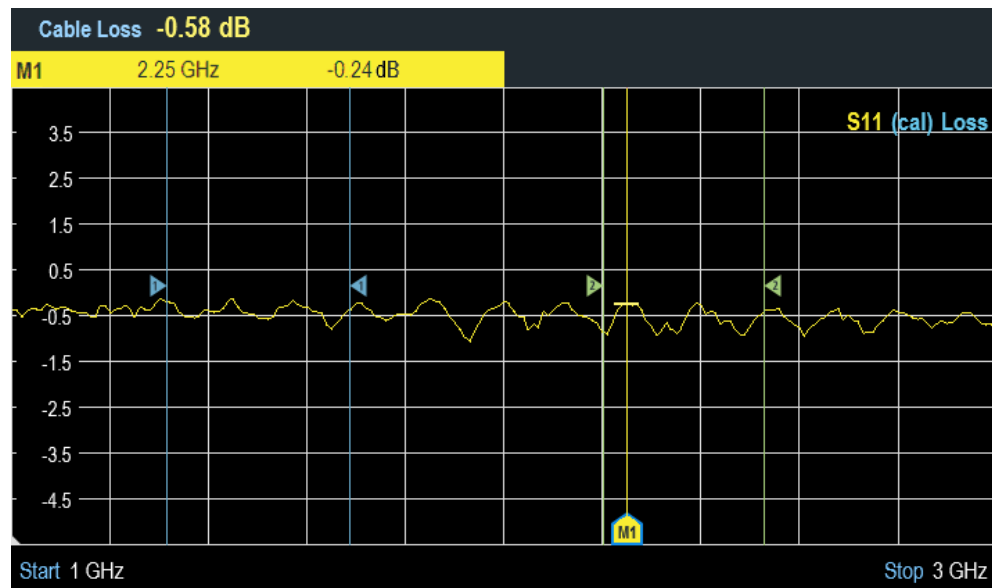

8. Define the "Upper Limit" menu item the same way.
9. Alternatively, select the "Select Marker" softkey.
10. Select the "Selected Marker" softkey.  
The R&S ZNH opens the submenu to select the search range menu items.
11. Select "Search Range 1" or "Search Range 2" menu item.  
The R&S ZNH activates the selected search range limit of the selected marker.

### Deactivating marker search limits

1. Press the "Selected Marker" softkey.  
The R&S ZNH opens the submenu to select the search range menu items.
2. Select the "Search Range Off" menu item.  
The R&S ZNH turns off the marker search limit function for the selected marker.
3. To turn off the marker search limits function for all markers, select "All Markers" softkey and repeat the above steps

### View list

You can hide or view the display of the [Measurement result view](#).



### Special touchscreen gesture

Swipe up or down vertically on the [Measurement result view](#) to hide or unhide the marker list.

See [Chapter 5.1.7, "Hide or unhide measurement result view display"](#), on page 75.

1. Press the [MARKER] key.
2. Select the "View List" softkey.  
The R&S ZNH hide or un-hide the [Measurement result view](#), depending on its original state.

## 7.3.3 Using display line

Like markers, display line helps you to determine the level of the signal.

A display line is a blue straight line that runs horizontally and corresponds to a certain level value. You can move the display line to each pixel in the display. This means that the accuracy and exact vertical position of the display line depends on the resolution of the vertical axis.

With a display range of 100 dB, for example, each pixel corresponds to 0.3 dB. In that case, the accuracy of the display line is 0.3 dB. If you enter a value with a higher resolution, the R&S ZNH rounds that value. See [Figure 4-1](#).

You can also move the display line with the rotary knob. The step size for movement with the rotary knob is one pixel.

1. Press the [LINES] key.
2. Select the "Display Line" softkey.  
The R&S ZNH displays the display line as a blue horizontal line. It shows the vertical position of the line in a table above the diagram area.  
When you activate the display line, the R&S ZNH also opens an input field to define the vertical position of the line.

3. Enter the level value you need.  
The R&S ZNH positions the display line accordingly.  
Alternatively, you can also move the display line with the rotary knob.

### 7.3.4 Using limit lines

Limit lines help you to identify if a signal complies with certain level characteristics.

A limit line is made up out of two or more points that are connected to a line. Each of the points that define the shape of the limit line consists of two coordinates. One coordinate defines the horizontal position (e.g. frequency), the other one the vertical position. With the R&S ZNH, you can build limit lines that consist of up to 1000 points.

Values that define the horizontal characteristics of the limit line can be either absolute values (e.g. frequency in MHz) or relative values whose reference is the center of the measurement trace (e.g. the center frequency). Relative values are of advantage if you, for example, measure modulated output signals and you change the center frequency but need the limit line to remain the same. Absolute limit lines have the file extension ".abslim" while relative limit lines have the file extension ".rellim"

Values that define the vertical characteristics are always level values in dB. If the scaling of the vertical axis is currently a linear one (units V or W), the R&S ZNH automatically switches to a logarithmic scaling after you turn on the limit line.

After turning on a limit line, the R&S ZNH checks if the signal violates the shape of the limit line. If one or more signal levels exceed the limit value, the R&S ZNH features several indicators that the limit check has failed.

- A general message in the diagram header that indicates if the signal violates the limit line, including the trace that violates the limit: 
- An audio signal that sounds every time a limit is violated

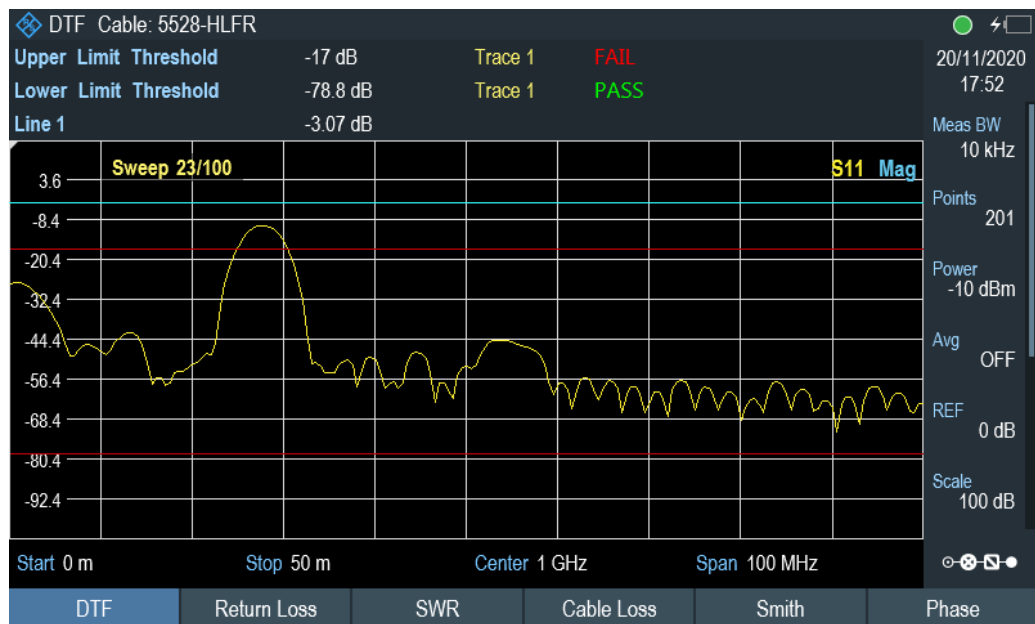

Figure 7-14: Upper and lower limit lines

You can create and edit limit lines with the R&S InstrumentView software and then transfer them into the internal memory of the R&S ZNH. The number of limit lines you can store in the memory depends on other datasets available on the R&S ZNH or if you are using an external storage device (e.g. memory stick).

For more information on limit lines, see [Chapter 5.8, "Managing datasets"](#), on page 87.

#### 7.3.4.1 Selecting a limit line

Before selecting a limit line, you need to decide if you want to use it as an upper or lower limit line. In case of upper limit lines, the R&S ZNH checks if the signal is above the limit line. In case of lower limit lines, the R&S ZNH checks if the signal is below the limit line.

You also have to make sure that the limit line is compatible to the scale of the horizontal axis.

1. Press the [LINES] key.
2. Depending on the application, press the "Upper Limit" or "Lower Limit" softkey.
3. Select the "Load From File" menu item.  
The R&S ZNH opens the file manager to select the limit line.
4. Select one of the available limit lines.
5. Press the "Load" softkey.  
The R&S ZNH activates the limit line. In the diagram, the limit line is displayed as a red line. See [Figure 7-14](#).

If you have already selected a limit line, you can turn the limit line on and off with the "Show Limit Lines" softkey.

Alternatively, you can define a threshold that works like a limit line. A threshold is a simple horizontal limit line.

1. Press the "Upper Limit" or "Lower Limit" softkey.
2. Select the "Set Threshold" menu item.  
The R&S ZNH opens an input field to define the threshold.
3. Enter the threshold you require.  
The R&S ZNH displays the line and performs a limit check for that threshold.



#### Threshold line and display line

Like the display line, a threshold line is a straight horizontal line. The difference is that the R&S ZNH performs a limit check for threshold lines, but not for display lines.

A failed limit check may be an issue if you want to create a measurement report, because measurements with failed limits are not included in this report.

Using a display line, you can use a line and are able to create a measurement report at the same time, regardless if any limits have been violated or not.

The process of turning off a limit line completely is similar to that of selecting a line.

1. Press the "Show Limit Lines"  
The R&S ZNH hides the limit line.
2. To remove the limit lines, select the "Upper Limit" or "Lower Limit" softkey.
3. Select the "Remove" softkey.  
The R&S ZNH removes the limit line.

#### 7.3.4.2 Performing limit checks



#### Limit violation

Note that a limit check fails only if the signal exceeds the limit line. If the signal level is the same as the limit value, the limit check passes.

If limit lines are active, the R&S ZNH automatically checks the trace for limit violations after each frequency sweep. As long as the signal does not violate the limit line, the R&S ZNH shows a "Pass" message in the measurement diagram. When one single value (i.e. one pixel) is outside of the limits, the R&S ZNH displays a "Fail" message in the diagram area and, in addition, sounds a beep.

A limit check relates only to the frequency range defined by the limit line, not the span.

**Audio signal**

You can turn the acoustic signal that sounds in case of a limit violation on and off.

- ▶ Select the "Audio Beep" menu item.  
Once selected, the audio beep is active, the R&S ZNH beeps each time a limit is violated.



## 8 Vector network analysis

The network analyzer mode provides the functionality to characterize networks with one or two test ports.

All R&S ZNH models have a tracking generator and VSWR bridge that are necessary to use the network analyzer. The network analyzer provides measurements to determine the reflection or transmission characteristics in both directions of the device under test (DUT). In addition to the magnitude of the transmitted and reflected power, vector measurements also determine the phase characteristics of the DUT.

Although the accuracy of measurements is high in the default factory calibration, the R&S ZNH also provides all necessary calibration methods to correct the magnitude for these kinds of measurements and make results even more accurate.

1. Press the [MODE] key.
2. Select the "Vector Network Analyzer" softkey.  
The R&S ZNH starts the vector network analyzer (VNA) mode and turns on the tracking generator.

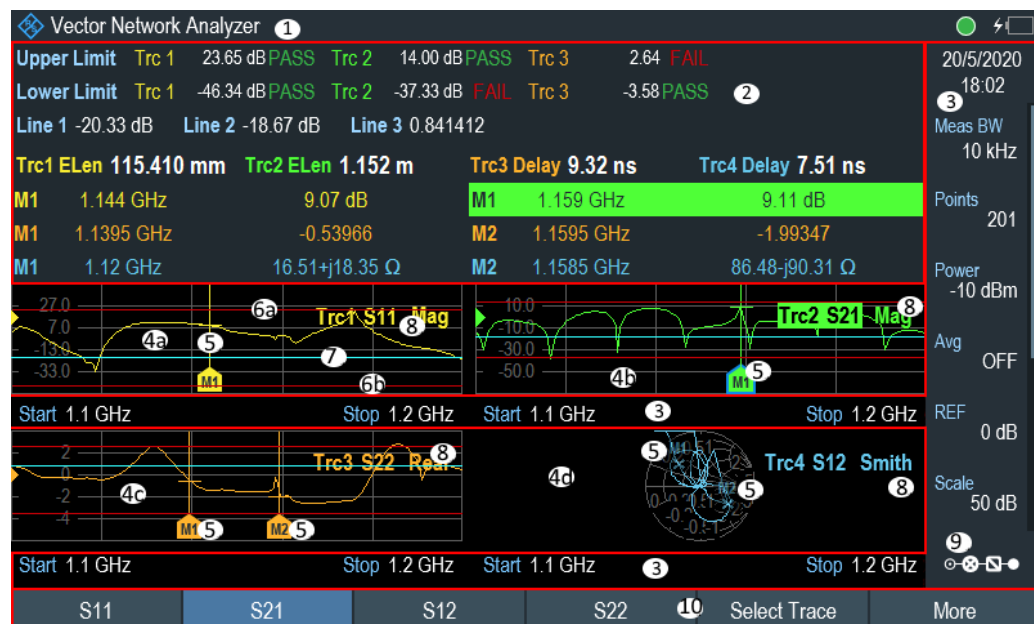

Figure 8-1: Screen layout of the network analyzer

- 1 = Title bar
- 2 = Measurement result view
- 3 = Parameter view
- 4a, 4b, 4c, 4d = Up to four different measurement trace windows are displayed, see [Measurement trace window](#)
- 5 = Up to six different markers can be used in a measurement trace window. A total of six markers are displayed in all trace window combinations.
- 6a, 6b = Upper and lower test limits
- 7 = Display line

- 8 = Trace label
- 9 = Configuration overview
- 10 = Network analyzer softkey menu

### Defining the output level of the test port power (tracking generator)



#### Test port power output level

Using an output level of 0 dBm (or a receiver attenuation of 0 dB) for S12 or S21 measurements can cause an overload at the RF input. It is therefore recommended to use an output level of -10 dBm (default) or lower for these measurements. This especially applies to measurements on amplifiers.

The tracking generator generates a signal at the current R&S ZNH frequency. The nominal output level of the signal is adjustable from -25 dBm to 0 dBm in steps of 1 dB.

1. Press the [SCALE/AMPT] key.
2. Select the "Port Config" softkey.  
The R&S ZNH opens a submenu to select the test port configuration settings.
3. Select the "Port Power" menu item.  
The R&S ZNH opens an input field to set the output level.  
The output power of the tracking generator is in the range from -25 dBm and 0 dBm.  
By default, the output power is configured at -10 dBm. To set a level higher than -5 dBm, the "Range" parameter needs to change from "Leveled" to "Max Range".
4. Alternatively, set the "Rcv Attn Port 1" or "Rcv Attn Port 2" receiver attenuation to reduce the signal level.  
Select the "Rcv Attn Port 1" or "Rcv Attn Port 2" from the "Port Config" submenu.  
The R&S ZNH opens an input field to set the attenuator level.
5. Enter the required value.
6. Confirm the value with a unit key.

## 8.1 Calibrating measurements

In its default state, the R&S ZNH uses factory calibration. Factory calibration is a full 2-port calibration over the complete frequency range of the R&S ZNH model. By default, the factory calibration is active, but this can be overwritten by user calibration (see [Chapter 8.1.3, "Performing calibration"](#), on page 157). In many cases, the factory calibration already provides accurate results.

To get the best and most accurate results, you have to calibrate the measurement manually, because factory calibration does not take the actual test setup into account (e.g. cables). The R&S ZNH provides several calibration methods. You will need one of the available calibration standards R&S FSH-Z28, -Z29 (order no. 1300.7804.03 and 1300.7504.03) or R&S ZV-Z121 (order no. 1164.0496.02/.03).

Alternatively, you can create customized calibration kits with the functionality of the R&S InstrumentView software package and transfer those to the R&S ZNH.

To successfully calibrate the test setup, you have to connect the calibration standard at the reference plane, usually the output of the RF measurement cable.

Before you calibrate the R&S ZNH for the current measurement, you should set the frequency parameters, reference level, measurement bandwidth and attenuation levels. If you change one of these parameters after a successful calibration, it may become invalid.

During calibration, the R&S ZNH removes systematic errors from the measurement. This process is based on correction data it gets while performing the calibration.

The correction data for transmission measurements is based on the results of comparing the transmission characteristics of the test setup to the frequency response of the tracking generator. The correction data for reflection measurements is based on the results of a reflection measurement at a short and an open on the bridge.

Calibration remains valid after turning off the R&S ZNH or changing into another operating mode as calibration data is saved in the internal memory of the R&S ZNH. If you save the measurement in a dataset, calibration data is part of that dataset. When you restore the dataset and perform the same measurement again, you do not have to recalibrate the R&S ZNH.

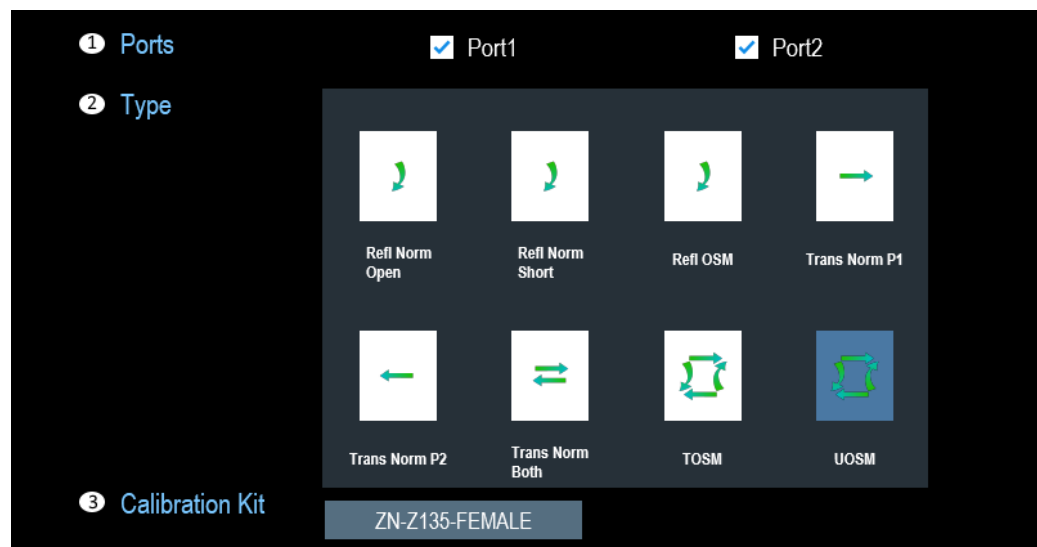

**Figure 8-2: Calibration configuration dialog**

1 = Test port combination, see ["RF port 1 / RF port 2"](#) on page 25

2 = Calibration type, see [Chapter 8.1.2, "Calibration methods"](#), on page 156

3 = Calibration kits, see [Chapter 7.1.9.3, "Calibration kit"](#), on page 128

### 8.1.1 Calibration states

The calibration states are the same as in the cable and antenna analyzer. For more information, see [Chapter 7.1.9.1, "Calibration states"](#), on page 125.

### 8.1.2 Calibration methods

The R&S ZNH provides several calibration methods on one or two test ports for vector measurements.

- **Refl Norm Open**  
The reflection normalization calibration routine requires connection of the Open standard to the selected test ports. It is used to derive reflection tracking error terms.
- **"Refl Norm Short"**  
The reflection normalization calibration routine requires connection of the Short standard to the selected test ports. It is used to derive reflection tracking error terms.
- **"Refl OSM"**  
The full one-port calibration routine requires a Short, an Open and a Match standard to be connected to the selected test port. It is used to derive source match, reflection tracking and directivity error terms.
- **"Trans Norm P1"**  
The transmission normalization calibration routine requires a Through standard from Port1 to Port2. It is used to derive transmission tracking error term.
- **"Trans Norm P2"**  
The transmission normalization calibration routine requires a Through standard from Port2 to Port1. It is used to derive transmission tracking error term.
- **"Trans Norm Both"**  
The transmission normalization calibration routine requires a Through standard from both test ports (Port1 to Port2 and Port2 to Port1). It is used to derive transmission tracking error term for each direction.
- **"TOSM"**  
The TOSM is a calibration routine requires the same standard as "Refl OSM" with a Through standard from both test ports. All measurements are performed in the forward and reverse direction. It is used to derive the source match, reflection tracking error and directivity error at all source ports, and transmission tracking error terms for each direction.
- **"UOSM"**  
The classic TOSM does not provide direct calibration of test setups for DUT equipped with different types of connectors at the input and output. The UOSM is used to overcome such problem, it involves the same as effort as TOSM calibration, but with unknown Through standard.  
It can be selected as follows:
  - If different connector types are assigned to the test ports, the analyzer automatically replaces TOSM by UOSM.
  - If the same connector types are used but an appropriate Through standard is not defined, the analyzer also replaces TOSM by UOSM.
  - UOSM can be selected explicitly in the [Figure 8-2](#).
- **"TRL"**  
Through-reflect-line calibration routine is especially useful for planar line technology (e.g. test fixtures, on-wafer measurements) where it is difficult to design and connect accurately modeled Open, Short or Match standards. The calibration rou-

tine requires a Reflecting one-port standard at both test ports and the two-port standards Through and Line.

The magnitude of the reflection coefficient of the Reflect standard can be unknown but must be nonzero; its phase must be roughly known (90 deg). The magnitude and phase of the reflection coefficient must be the same at both test ports.

As a rule, singularities are avoided with sufficient accuracy if the phase shift resulting from the (electric) length difference between the Through and the Line standard is between 20° and 160°. This corresponds to a ratio of 1:8 for the start and stop frequency of the calibrated sweep range.

The TRL calibration routine is used to derive the source match, reflection tracking error and directivity error at all source ports, and transmission tracking error terms for each direction.

Each calibration method is suitable for certain kinds of measurement tasks.

- For high isolation measurements, use the normalization and isolation calibration methods.
- For filter measurements requiring high standards (for example S11 in passband better than -20 dB), use the full 2-port calibration.
- For full S-parameter measurements on attenuators or amplifiers, use the full 2-port calibration.

### 8.1.3 Performing calibration



- A successful calibration supersedes the previous calibration, discarding all previous system error correction data.

The procedure is similar for all calibration methods, except that you are going to need different type and number of calibration standards.

1. Disconnect the DUT from the RF cable.  
After disconnecting the DUT, the R&S ZNH is ready for calibration.
2. Press [CAL] key.
3. Select "Cal Config" softkey.  
The R&S ZNH displays the [Calibration configuration dialog](#).
4. Select the "Ports" ("Port1" and/or "Port2") to define the port assignments between the R&S ZNH and the calibration unit.  
The R&S ZNH extracts the "Connector" type and "Gender" of the connector from "Calibration Kit" file.
5. Select the calibration "Type" to perform the calibration standard.  
For more information, see [Chapter 8.1.2, "Calibration methods"](#), on page 156.
6. Select the calibration kit to load the required calibration file from the file manager.  
For a list of supported calibration kits, see [Chapter 7.1.9.3, "Calibration kit"](#), on page 128.

7. Select "Apply" to save the calibration configuration.

The R&S ZNH displays the [Chapter 4.1.4, "Measurement trace window"](#), on page 33.

If the calibration configuration is incompatible for the selected "Ports" and calibration "Type" settings, the R&S ZNH displays an invalid message.

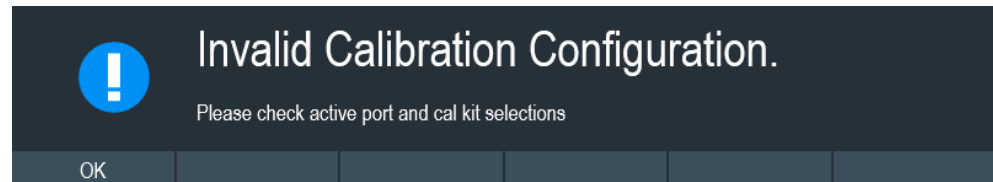

8. Select "Calibrate" softkey to proceed the user calibration.

The R&S ZNH displays the saved "Calibration Configuration" message box.

If you want to change the calibration configuration, select the "Cal Config" to make changes.

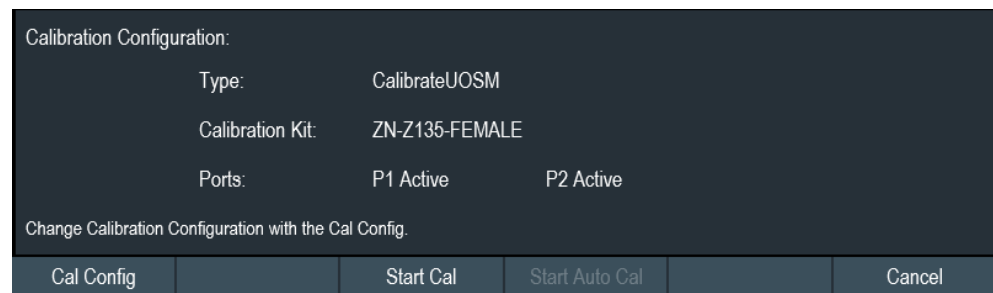

9. Select "Start Cal" to proceed the user calibration.

The R&S ZNH displays the calibration dialog with respect to the saved calibration configuration.

The following illustrates an example of the calibration standards associated to the USOM calibration method saved in the calibration configuration.

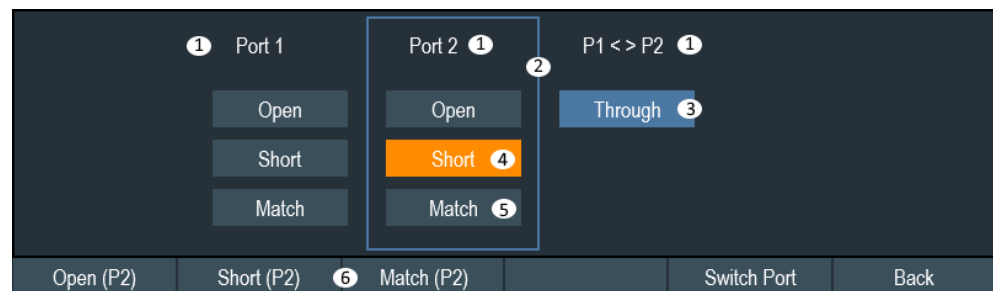

**Figure 8-3: Calibration dialog**

1 = Calibration test port, see ["RF port 1 / RF port 2"](#) on page 25

2 = Selected calibration test port

3 = Completed calibration standard

4 = Calibration standard in process

5 = Un-calibrated standard

6 = Softkey for calibration

10. You can randomly select any of the calibration standard ("Open", "Short", "Match", "Through", "Line") at different calibration test ports to proceed the calibration. Alternatively, press "Switch Port" to switch to the desired test port to proceed the calibration standard. Completed calibration standards are highlighted in blue, whereas port in calibration process is highlighted in orange. See [Figure 8-3](#).

## 8.2 Offset parameters

The functionality of offset parameters complements the R&S ZNH's calibration measurements. It compensates for the known length and loss of a (non-dispersive and perfectly matched) transmission line between the calibrated reference plane and the DUT.

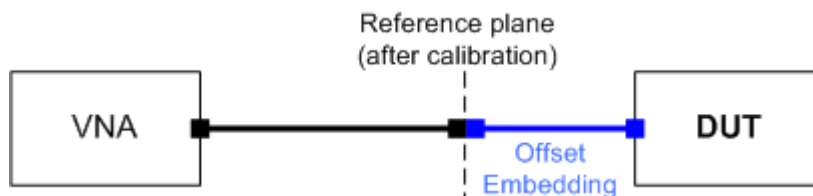

Figure 8-4: Compensation of offset embedding between reference plane and DUT

The R&S ZNH can also auto-determine length and loss parameters, assuming that the actual values should minimize the group delay and loss across the sweep range.

### 8.2.1 Definition of offset parameters

The *delay* is the propagation time of a wave traveling through the transmission line. The *electrical length* is equal to the delay times the speed of light in the vacuum. It is a measure for the length of the transmission line between the standard and the actual calibration plane. For a line with permittivity  $\epsilon_r$  and *mechanical length*  $L_{mech}$  the delay and the electrical length are calculated as follows:

$$Delay = \frac{L_{mech} \cdot \sqrt{\epsilon_r}}{c}; \quad Electrical\ Length = L_{mech} \cdot \sqrt{\epsilon_r}$$

1. Press [CAL] key.
2. Select "Offsets" > "Offset Settings" > "Length Config" menu.

The "Delay", "Electrical Length" and Mech. Length are coupled parameters. When one of them changed, the other two are adjusted accordingly.

For a non-dispersive DUT, the delay defined above is constant over the considered frequency range and equal to the negative derivative of the phase response for the frequency (see mathematical relations). The length offset parameters compensate for a constant delay, which is equivalent to a linear phase response.

## 8.2.2 Definition of loss parameters

The loss is the attenuation that a wave experiences when traveling through the transmission line. In logarithmic representation, it can be modeled as the sum of a constant and a frequency-dependent part, where the frequency dependence is due to the skin effect.

In the limit case, where the length of the transmission line is considered to be "almost zero", the loss is considered constant:

$$Loss(f) = Loss_{DC}$$

Otherwise, if the loss at DC and one additional frequency  $f_1$  is known (or measured), the loss at frequency  $f$  is approximated by:

$$Loss(f) = Loss_{DC} + (Loss(f_1) - Loss_{DC}) \cdot \sqrt{\frac{f}{f_1}}$$

If in addition the loss at a second frequency  $f_2$  is known (or measured), then the loss can be approximated by:

$$Loss(f) = Loss_{DC} + (Loss(f_1) - Loss_{DC}) \cdot \left(\frac{f}{f_1}\right)^b, \text{ where } b = \frac{\log_{10}\left(\frac{Loss(f_1) - Loss_{DC}}{Loss(f_2) - Loss_{DC}}\right)}{\log_{10}\left(\frac{f_1}{f_2}\right)}$$

In practice, the frequency-dependent part is often dominant, so that  $Loss_{DC}$  can be set to zero. Experimentally, the loss value at DC can be determined in a separate measurement at a very low frequency ( $f \rightarrow 0$ ).

## 8.2.3 Auto length

The "Auto Length" function adds an electrical length offset to the active trace's receive port, such that the residual delay of the active trace (defined as the negative derivative of the phase response) is minimized across a configurable frequency range. If "Delay" is the selected trace format, the entire trace is shifted in vertical direction and centered on zero. In phase format, the "Auto Length" corrected trace shows the deviation from linear phase.

### Length and delay measurement, related settings

"Auto Length" is suited for length and delay measurements on transmission lines.

1. Connect a (non-dispersive) cable to a single analyzer port no.  $n$  and measure the reflection factor  $S_{11} / S_{22}$ .
2. Press [CAL] > "Offsets" menu.
3. Select "Auto Length" to normalize active trace.

The delay is displayed in the "Delay" field, the cable length (depending on the "Velocity Factor") in the "Mech. Length" field.



It is also possible to determine cable lengths using a transmission measurement. Note that "Auto Length" always provides the **single** cable length and the delay for propagation in **one** direction.

#### **Preconditions for Auto Length, effect on measured quantities and exceptions**

The "Auto Length" is enabled if the measured quantity contains the necessary phase information as a function of frequency, and if the interpretation of the results is unambiguous:

- A frequency sweep must be active.
- The measured quantity must be an S-parameter, ratio, wave quantity, a converted impedance or a converted admittance.

The effect of "Auto Length" on S-parameters, wave quantities and ratios is to eliminate a linear phase response as described above. The magnitude of the measured quantity is not affected.

#### **Auto Length for logical ports**

The "Auto Length" function can be used for balanced port configurations as well. If the active test port is a logical port, then the same length offset must be assigned to both physical ports that are combined to form the logical port. If different length offsets have been assigned to the physical ports before, they are both corrected by the same amount.

### **8.2.4 Auto length and loss**

The "Auto Length and Loss" function determines all offset parameters at the active trace's receive port such that the residual group delay of the active trace (defined as the negative derivative of the phase response) is minimized **and** the measured loss is minimized as far as possible across a configurable frequency range.

"Auto Length and Loss" involves a two-step procedure:

- An "Auto Length" correction modifies the phase of the measured quantity, minimizing the residual group delay. The magnitude of the measured quantity is not affected.
- The automatic loss correction modifies the magnitude of the measured quantity, leaving the (auto length-corrected) phase unchanged.

#### **Preconditions for Auto Length and Loss, effect on measured quantities and exceptions**

"Auto Length and Loss" is enabled if the measured quantity contains the necessary phase information as a function of the frequency, and if the interpretation of the results is unambiguous:

- A frequency sweep must be active.
- The measured quantity must be an S-parameter, ratio, wave quantity.

The effect of "Auto Length and Loss" on S-parameters, wave quantities and ratios is to eliminate a linear phase response and account for a loss as described above.

### Calculation of loss parameters

The loss is assumed to be given in terms of the DC loss  $\text{Loss}_{\text{DC}}$ , the reference frequency  $f_{\text{ref}}$ , and the loss at the reference frequency  $\text{Loss}(f_{\text{ref}})$ . The formula used in the Auto Loss algorithm is similar to the formula for manual entry of the loss parameters (see [Chapter 8.2.2, "Definition of loss parameters"](#), on page 160).

The result is calculated according to the following rules:

- The reference frequency  $f_{\text{ref}}$  is kept at its previously defined value (default: 1 GHz).
- The DC loss  $c$  is zero except for wave quantities and for S-parameters and ratios with maximum dB magnitude larger than  $-0.01$  dB.
- "Auto Length and Loss" for a wave quantity centers the corrected dB magnitude as close as possible around 0 dBm.
- "Auto Length and Loss" for S-parameters and ratios centers the corrected dB magnitude as close as possible around 0 dB.

The resulting offset parameters are displayed in the [CAL] > "Offsets" > "Offset Settings" of the respective port.

### Auto Length and Loss for balanced ports

The "Auto Length and Loss" function can be used for balanced port configurations as well. If the active test port is a balanced (logical) port, then the same offset parameters must be assigned to both physical ports that are combined to form the logical port. If different offset parameters have been assigned to the physical ports before, they are both corrected by the same amount.

## 8.2.5 Application and effect of offset parameters

Offset and loss parameters can be particularly useful if the reference plane of the calibration cannot be placed directly at the DUT ports, e.g. because the DUT has non-coaxial ports and can only be measured in a test fixture. Offset parameters can also help to avoid a new complete system error correction if a cable with known properties has to be included in the test setup.

- A positive length offset moves the reference plane of the port towards the DUT, which is equivalent to deembedding the DUT by numerically removing a (perfectly matched) transmission line at that port.
- A negative offset moves the reference plane away from the DUT, which is equivalent to embedding the DUT by numerically adding a (perfectly matched) transmission line at that port.

The offset parameters are also suited for length and delay measurements; see [Chapter 8.2.3, "Auto length"](#), on page 160.

Each offset parameter is assigned to a particular port. The delay parameters affect the phase of all measured quantities related to this port; the loss parameters affect their magnitude. An offset at port 1 affects the S-parameters  $S_{11}$ ,  $S_{21}$ .



To account for the propagation in both directions, the phase shift of a reflection parameter due to a given length offset is twice the phase shift of a transmission parameter. If, at a frequency of 300 MHz, the electrical length is increased by 250 mm ( $\lambda/4$ ), then the phase of  $S_{21}$  increases by 90 deg, whereas the phase of  $S_{11}$  increases by 180 deg.

Equivalent relations hold for the loss.

If the trace is displayed in "Delay" format, changing the offset parameters simply shifts the whole trace in vertical direction.

The sign of the phase shift is determined as follows:

- A positive offset parameter causes a positive phase shift of the measured parameter and therefore reduces the calculated group delay.
- A negative offset parameter causes a negative phase shift of the measured parameter and therefore increases the calculated group delay.

### 8.2.6 Offset parameters for balanced ports

The offset parameters can be used for balanced port configurations:

- Offset parameters must be assigned to both physical ports of a logical port.
- "Auto Length" corrects the length offset of both physical ports of a logical port by the same amount.

## 8.3 Performing vector network analysis measurements

Unlike scalar measurements, vector measurements also measure the phase characteristics of DUT. Vector measurements have a higher dynamic range and accuracy because of the advanced calibration methods that vector measurements provide. For more information on the scalar measurement, see [Chapter 7.1, "Performing cable and antenna measurements"](#), on page 109.

In addition to normalization, vector measurements feature full calibration methods that require a 50  $\Omega$  termination in addition to an open or short circuit. Instead of the characteristics of the VSWR bridge, the decisive factor of the quality of results is the quality of the calibration standards. See [Chapter 8.1, "Calibrating measurements"](#), on page 154.

Because of the higher dynamic range, vector measurements allow more accurate measurements of well matched DUTs at a higher display resolution.

Vector measurements also unlock more measurement formats and therefore provide more information from different perspectives about the DUT.



### Supply DC voltage to active DUTs

If you are performing measurements on active DUTs (e.g. amplifiers), you can supply them with DC voltage by connecting an RF cable to the BIAS ports. The DC voltage (R&S K10) is fed in from a suitable external power supply (max. 600 mA/max. 50 V).



Simultaneously display of up to four different trace measurements (S-Parameters, Wave, Ratios) and formats (dB Mag, Linear, Phase, Smith, SWR, Polar and Group Delay) are possible via the [TRACE] > "Display" softkey selection.

The R&S ZNH can display a combination of up to four [measurement trace windows](#), respective trace measurements and formats are indicated on the [trace label](#).

Note that the simultaneous display of more than one result in a single diagram is only possible with a high accuracy calibration. See [Chapter 8.1, "Calibrating measurements"](#), on page 154.

### 8.3.1 S-Parameter measurements

S-parameters are the basic measured quantities of a network analyzer which describe how the DUT modifies a signal that is transmitted or reflected in the forward or reverse direction.

The following also shows when the source and load port are not ideally matched, part of the transmitted waves can be reflected off the receiver port. An additional  $a_2$  contribution occurs in forward measurements and  $a_1$  contribution occurs in the reverse measurement.

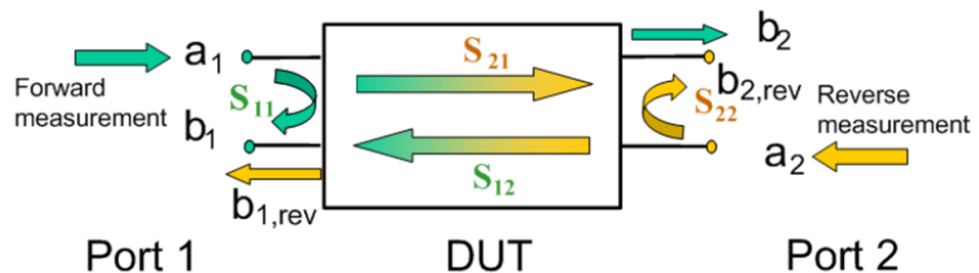

**Figure 8-5: 2-port measurement with signal flows**

$a_1$  = Incident wave at port 1

$b_1$  = Outgoing wave at port 1

$b_2$  = Outgoing wave at port 2

$a_2$  = Incident wave at port 2

$S_{11}$  = Reflection coefficient of DUT, the ratio between  $b_1$  and  $a_1$  in a forward measurement with matched DUT port 2, i.e.  $S_{11} = b_1 / a_1$ , if  $|a_1| > 0$  and  $a_2 = 0$

$S_{21}$  = Forward transmission coefficient, the ratio between  $b_2$  and  $a_1$  in a forward measurement with matched DUT port 2, i.e.  $S_{21} = b_2 / a_1$ , if  $|a_1| > 0$  and  $a_2 = 0$

$S_{12}$  = Reverse transmission coefficient, the ratio between  $b_1$  and  $a_2$  in a forward measurement with matched DUT port 1, i.e.  $S_{12} = b_1 / a_2$ , if  $|a_2| > 0$  and  $a_1 = 0$

$S_{22}$  = Reflection coefficient of DUT port 2, the ratio between  $b_2$  and  $a_2$  in a forward measurement with matched DUT port 1, i.e.  $S_{22} = b_2 / a_2$ , if  $|a_2| > 0$  and  $a_1 = 0$

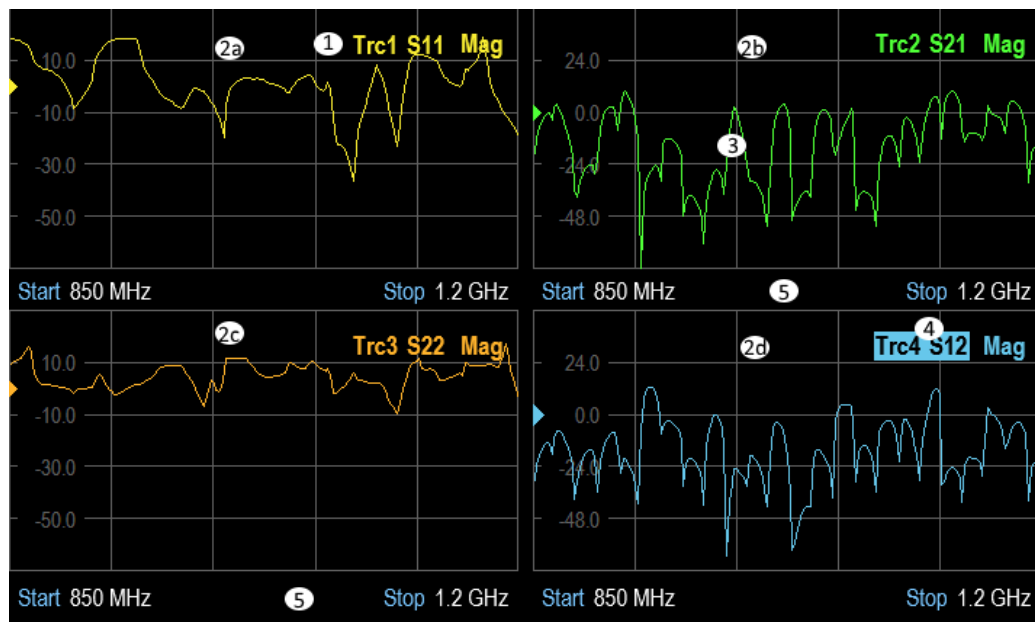

Figure 8-6: S-parameters measurements in quadrant measurement trace windows display

- 1 = Trace label
- 2a, 2b, 2c, 2d = Up to four different combinations of Measurement trace window
- 3 = Trace measurement
- 4 = Selected trace
- 5 = Same start and stop horizontal domain (e.g. frequency)

1. Press the [MEAS] key.
2. Select the required S-parameters measurement ("S11", "S21", "S12", "S22") soft-key for S-parameters measurement.  
The R&S ZNH performs the selected S-parameters measurement.  
For more information on transmission and reflection measurement, see [Chapter 4.5.1, "Transmission measurement"](#), on page 64 and [Chapter 4.5.2, "Reflection measurement"](#), on page 65.

### 8.3.2 Wave measurements



#### R&S ZNH option

R&S ZNH-K66 (order number 1334.6869.02) option is required for the wave measurements. See also [Chapter 8.3.2, "Wave measurements"](#), on page 165.

A wave quantity measurement provides the power (dBm) of any of the transmitted or received waves.

The wave quantities provide the power at the receive ports of the analyzer. This is different from an S-parameter measurement, where the absolute power of a linear DUT is

canceled. Wave quantities are therefore suitable for the analysis of nonlinearities of DUT and also as a selective power meter.

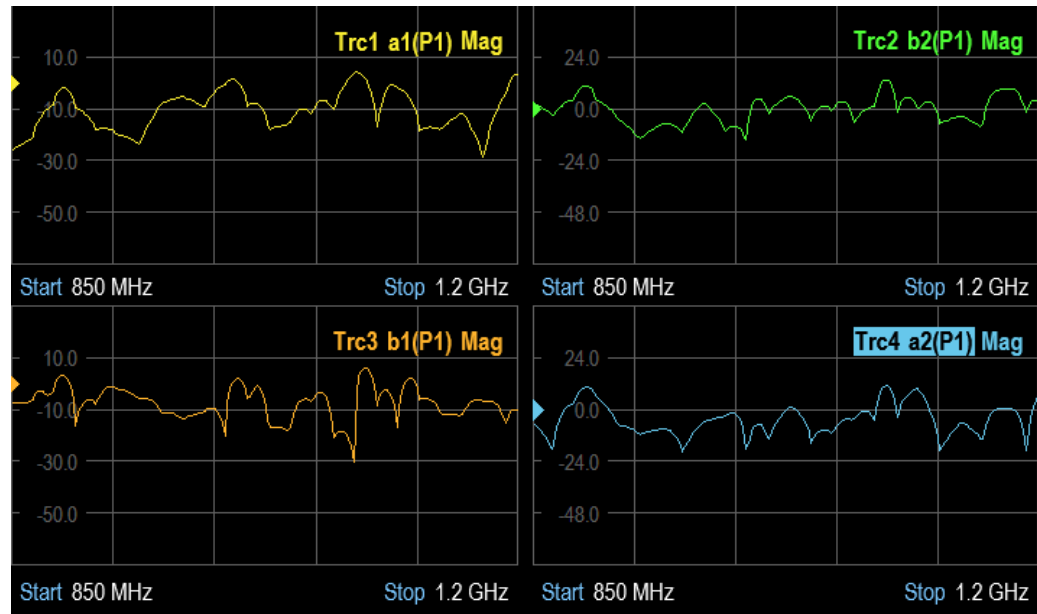

Figure 8-7: Wave measurements in quadrant measurement trace windows display

1. Press the [MEAS] key.
2. Select "More > Wave" for wave measurement.
3. Select the required **wave measurement** ("a1", "b1", "a2", "b2") softkey.  
The R&S ZNH performs the selected wave measurement.
4. Select "Driving Port" to switch signal source on the driving port.  
The R&S ZNH display a submenu to select "Port 1" or "Port 2" for the signal source.

With reference to [Figure 8-5](#), the following notations for wave quantities are followed:

Notation	Description
$a_i$ Src Port j	Incoming wave at DUT port i, when DUT port j ("Driving Port") is stimulated. $a_i$ is detected at the reference receiver of the VNA port connected to DUT port i.
$b_i$ Src Port j	Outgoing wave at DUT port i, when DUT port j ("Driving Port") is stimulated. $b_i$ is detected at the measurement receiver of the VNA port connected to DUT port i.

In a standard forward S-parameter measurement,  $a_1$  Src Port 1 is the incident wave and  $b_1$  Src Port 1 is the reflected wave at DUT port 1.

### 8.3.3 Ratios measurements



#### R&S ZNH option

R&S ZNH-K66 (order number 1334.6869.02) option is required for the ratios measurement. See also [Chapter 8.3.2, "Wave measurements"](#), on page 165.

Ratios provide the complex ratio of any combination of transmitted or received wave quantities. Ratios complement the S-parameters measurements, where only ratios of the form  $b_i/a_j$  (ratios between outgoing and incoming waves at the DUT ports) are considered.

A measurement of ratios is particularly suitable in the following test scenarios:

- The test setup or some of its components (e.g. active components or non-reciprocal devices) do not allow a system error correction so that a complete S-parameter measurement is not possible.
- The test setup contains frequency-converting components so that the transmitted and the received waves are at different frequencies.
- A ratio of two arbitrary waves that is not an element of the S-matrix (e.g. a ratio of the form  $a_i/a_j$ ) is needed.

The notation for ratios is similar to the notation for [wave quantities](#). Given a source port  $k$ , any ratio between wave quantities " $a_i$  Src Port  $k$ " and " $b_j$  Src Port  $k$ " can be measured.

#### Example:

- " $b_2/a_1$  Src Port" is the ratio of the outgoing wave at DUT port 2 and the incident wave at DUT port 1 (i.e. DUT port 1 is stimulated). This corresponds to the forward transmission coefficient  $S_{21}$ .
- " $b_1/a_1$  Src Port 1" is the ratio of the outgoing wave at DUT port 1 and the incident wave at DUT port 1 (i.e. DUT port 1 is stimulated). This corresponds to the forward reflection coefficient  $S_{11}$ .

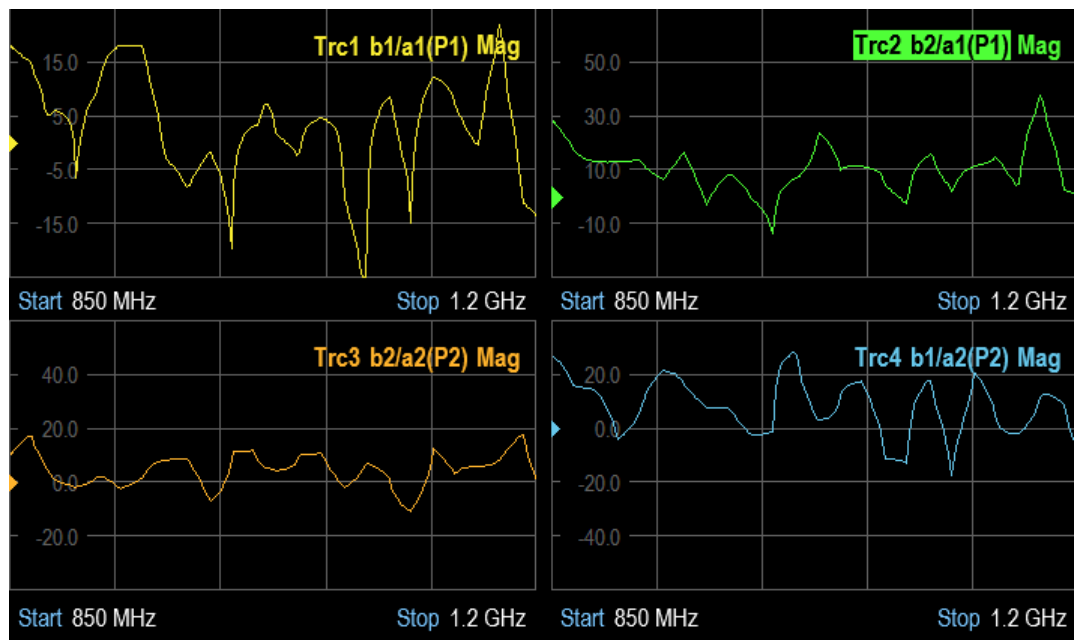

1. Press the [MEAS] key.
2. Select "More > Ratios" for ratios measurement.
3. Select the required **ratios measurement** ("b1/a1(P1)", "b2/a1(P1)", "b1/a2(P2)", "b2/a2(P2)") softkey.  
The R&S ZNH performs the selected wave measurement.
4. To perform ratios measurement that is not an S-matrix element, select "More" softkey.  
The R&S ZNH displays the "Numerator" and "Denominator" for ratio settings
5. Select the ratio settings.  
The R&S ZNH displays a submenu to select the ratio element.
6. Select "Driving Port" to switch signal source on the driving port.  
The R&S ZNH displays a submenu to select "Port 1" or "Port 2" for the signal source.
7. Select the required driving port.  
The R&S ZNH switches the signal source from the selected port.

### 8.3.4 Mixed mode measurements



#### R&S ZNH option

R&S ZNH-K47 (order number 1334.6875.02) option is required for the mixed mode measurement.



## Performing vector network analysis measurements

Mixed mode measurements are an extension of [S-parameters](#) for balanced measurements. With mixed mode measurements, the R&S ZNH simulates unbalance-balance transformers (baluns) integrated in the measurement circuit. It converts the DUT ports from an unbalanced state into a balanced state and virtually separates the differential and common mode signals. Two physical ports on the R&S ZNH are combined to form one balanced logical port. See [Figure 8-8](#).

The R&S ZNH measures the unbalanced state but converts the results and calculates mixed mode S-parameters. No physical transformer is needed.

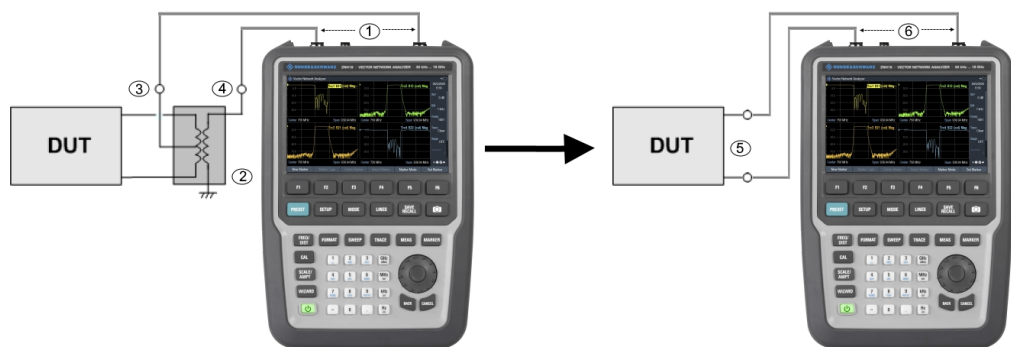

**Figure 8-8: Unbalanced to balance measurement**

- 1 = Physical ports
- 2 = Physical transformer (balun)
- 3 = Common mode
- 4 = Differential mode
- 5 = Balanced port
- 6 = Logical port

Unbalance-balance conversion avoids the disadvantages of real transformers:

- There is no need to fabricate test fixtures with integrated baluns for each type of DUT
- The measurement is not impaired by the non-ideal characteristics of the balun (e.g. error tolerances, limited frequency range)
- Calibration can be performed at the DUT's ports. If necessary (e.g. to compensate for the effect of a test fixture), it is possible to shift the calibration plane using length offset parameters.
- Differential and common mode parameters can be evaluated with a single test setup

In general, the notation of a mixed mode S-parameter is  $S_{\langle \text{mout} \rangle \langle \text{min} \rangle \langle \text{out} \rangle \langle \text{in} \rangle}$  where  $\langle \text{mout} \rangle$  and  $\langle \text{min} \rangle$  denote the output and input port modes,  $\langle \text{out} \rangle$  and  $\langle \text{in} \rangle$  denote the output and input port number. If the  $\langle \text{mout} \rangle$  is different from  $\langle \text{min} \rangle$ , the S-parameters are called mode conversion factors.

For the following examples of test setups, mixed mode parameters can be obtained:

- DUT with only single ended ports: No balanced port definition necessary, the R&S ZNH provides single-ended dual port parameters (see [Chapter 8.3.1, "S-Parameter measurements"](#), on page 164).

## Performing vector network analysis measurements

- DUT with one balance port: Only reflection and mode conversion measurements with differential and common mode parameters

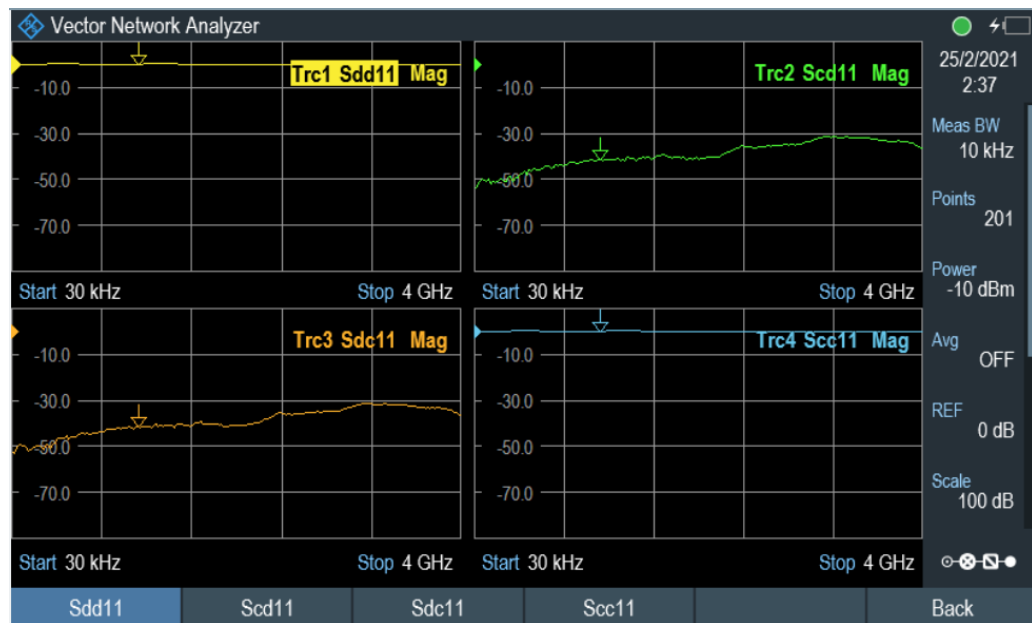
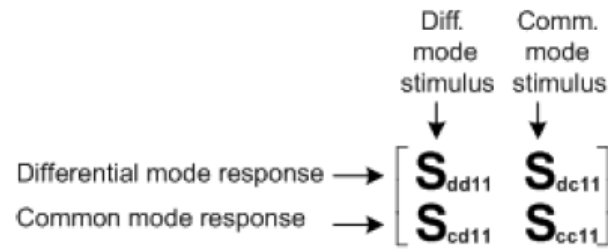

Figure 8-9: Mixed mode measurements in quadrant measurement trace windows display

1. Press the [MEAS] key.
2. Select "More > Mixed Mode" for mixed mode measurement.
3. Select the required mixed mode ("Sdd11", "Scd11", "Sdc11", "Scc11") softkey. The R&S ZNH performs the selected mixed mode measurement.

### 8.3.5 Time domain analysis



#### R&S ZNH option

R&S ZNH-K68 (order number 1334.6881.02) option is required for the time domain analysis measurement.

The R&S ZNH measures and displays complex S-parameters and other quantities as a function of the frequency. The measurement results can be filtered and mathematically

transformed to obtain the time domain representation, which often gives a clearer insight into the characteristics of the DUT.

Time domain transforms can be calculated in [band pass](#) or [lowpass mode](#). For the latter, the R&S ZNH offers the impulse and step response as two alternative transformation types. A wide selection of windows can be used to optimize the time domain response and suppress side lobes due to the finite sweep range. Additionally, it is possible to remove unwanted responses using a [time gate](#) and transform the gated result back into the frequency domain.

For more information on the application of time domain transformation, you can refer to application note 1EZ44 which is available on the R&S internet at [http:// www.rohde-schwarz.com/appnotes/1EZ44](http://www.rohde-schwarz.com/appnotes/1EZ44).

1. Press "FREQ/DIST"
2. Select "Time Domain" softkey.  
The R&S ZNH displays a submenu to select the time domain settings.
3. Select "Time Domain" to enable the time domain measurement.
4. Select "Time X-Axis" or "Distance X-Axis" to define the x-axis for the time domain measurement.
5. Select the "Frequency Range" to define measurement frequency.

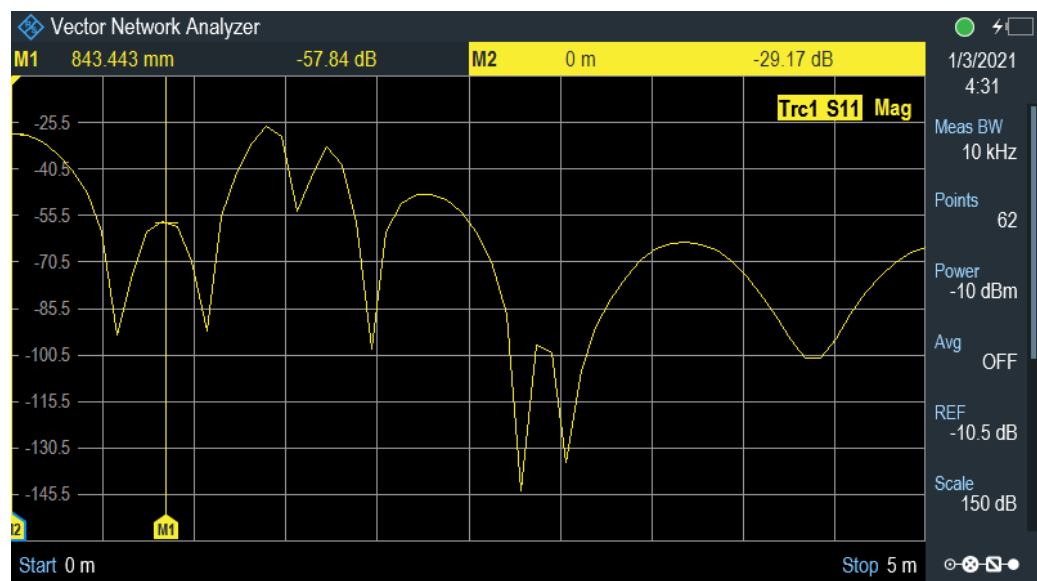

### 8.3.5.1 Band pass and low pass mode

The R&S ZNH provides two different types of time domain transforms:

#### **Band pass mode:**

The time domain transform is based on the measurement results obtained in the sweep range between any set of positive start and stop values. The sweep points must

be equidistant. No assumption is made about the measurement point at zero frequency (DC value). The time domain result is complex, with an undetermined phase depending on the delay of the signal.

### Low pass mode:

The measurement results are continued towards  $f = 0$  (DC value) and mirrored at the frequency origin so that the effective sweep range (and thus the response resolution) is more than doubled. Together with the DC value, the condition of equidistant sweep points implies that the frequency grid must be harmonic. Due to the symmetry of the trace in the frequency domain, the time domain result is harmonic.

See also [Chapter 8.3.5.3, "Harmonics grid"](#), on page 174.

Two different types of response are available in low pass mode, see [Table 8-1](#).

**Table 8-1: Comparison of band pass and low pass mode**

Transform type	Band pass	Low pass
Advantages	Easier to use: works with any set of equidistant sweep points	Higher response resolution (doubled) Includes information about DC value Real result Impulse and step response
Restrictions	No step response Undetermined phase	Needs harmonic grid
Applications	Scalar measurements where the phase is not needed DUTs that do not operate down to $f = 0$ (e.g. pass band or high pass filters)	Scalar measurements where the sign is of interest DUTs with known DC value

### Impulse and step response

In low pass mode, the R&S ZNH can calculate two different types of responses:

- The impulse response corresponds to the response of a DUT that is stimulated with a short pulse.
- The step response corresponds to the response of a DUT that is stimulated with a voltage waveform that transitions from zero to unity.

The two alternative responses are mathematically equivalent; the step response can be obtained by integrating the impulse response:

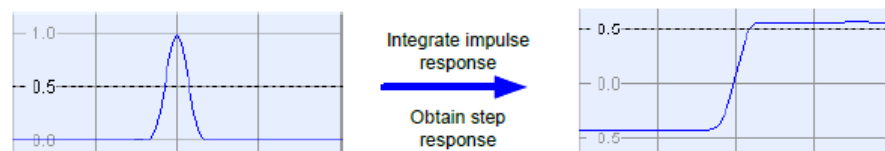

The step response is recommended for impedance measurements and for the analysis of discontinuities (especially inductive and capacitive discontinuities). The impulse

response has an unambiguous magnitude and is therefore recommended for most other applications.

1. Press "FREQ/DIST"
2. Select "Time Domain" softkey.  
The R&S ZNH displays a submenu to select the time domain settings.
3. Select "Time Domain Config" to display the "Time Domain" dialog.

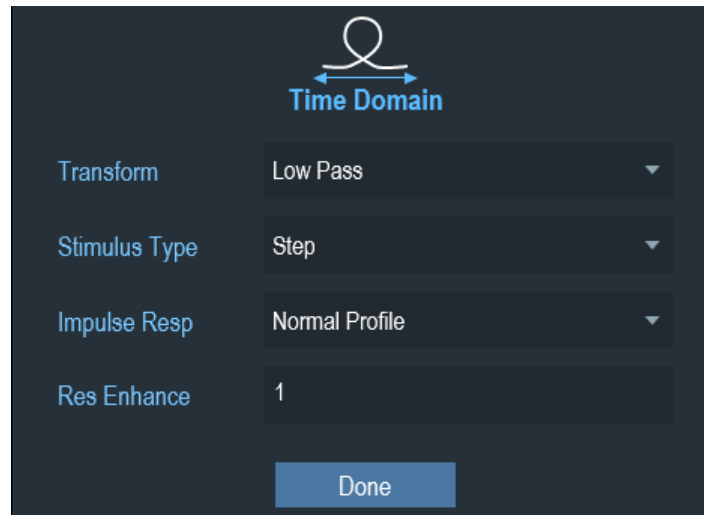

Figure 8-10: Time domain dialog

4. Select "Transform" to set the time domain transform.
  - See [Band pass](#) mode.
  - See [Low pass](#) mode.
5. For low pass mode, select the required "Stimulus Type", "Impulse Resp." and "Res Enhance" to set the type of signal input and impulse response characteristics to optimize measurement.  
See "[Impulse and step response](#)" on page 172 and [Chapter 8.3.5.2, "Windows in the frequency domain"](#), on page 173.
6. Set the "Time Domain Range" to define the time domain range.

### 8.3.5.2 Windows in the frequency domain

The finite sweep range in a frequency domain measurement with the discontinuous transitions at the start and stop frequency broadens the impulses and causes side lobes (ringing) in the time domain response. The impulse response window offered in the [time domain](#) dialog can reduce this effect and optimize the time domain response. See [Table 8-2](#).

Table 8-2: Properties of impulse response windows

Window	Side lobe suppression	Relative impulse width	Application
"No Profiling" (Rectangle)	13 dB	1.0	-
"Low1stSidelobe"	43 dB	1.4	Response resolution: separation of closely spaced response with comparable amplitude
"Normal Profile"	32 dB	1.6	Good compromise between pulse width and side lobe suppression
"Steep Falloff"	46 dB	1.9	Dynamic range: separation of distant responses with different amplitude

### 8.3.5.3 Harmonics grid

A harmonic grid is formed by a set of equidistant frequency points  $f_i$  ( $i = 1 \dots n$ ) with spacing  $\Delta f$  and the additional condition that  $f_1 = \Delta f$ . In other words, all frequencies  $f_i$  are set to harmonics of the start frequency  $f_1$ .

If a harmonic grid, including the DC value ( $f = 0$ ), is mirrored to the negative frequency range, the result is again an equidistant grid.

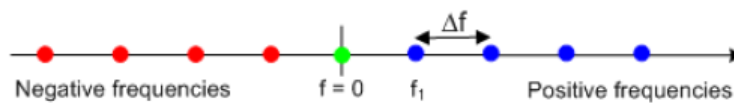

The point symmetry with respect to the DC value makes harmonic grids suitable for lowpass time domain transformations.

#### Visualization of the harmonic grid algorithms

The R&S ZNH provides three different algorithms for harmonic grid calculation. The three harmonic grids have the following characteristics:

- Keep "Stop Freq, Nr. Of Points" means that the stop frequency and the number of sweep points is maintained. The sweep points are redistributed across the range between the minimum frequency of the analyzer and the stop frequency; the step width can be increased.

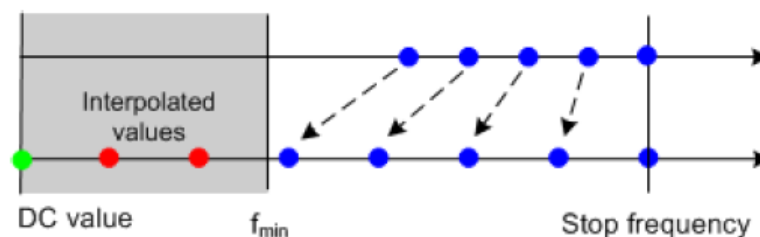

- Keep "Freq Gap, Nr. Of Points" means that the number of sweep points and their relative spacing is maintained. If the start frequency of the sweep is sufficiently above the  $f_{min}$ , the entire set of sweep points is shifted towards lower frequencies so that the stop frequency is decreased.

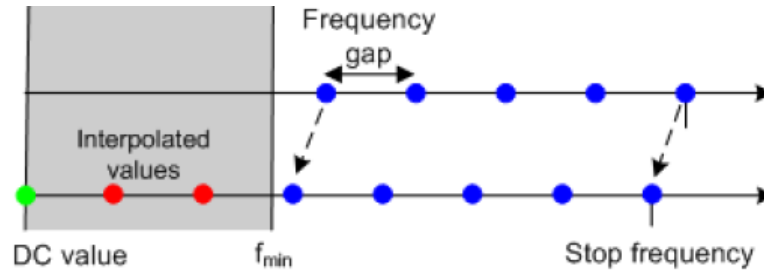

- If the start frequency of the sweep is close to  $f_{min}$ , then the sweep points can have to be shifted towards higher frequencies. If the last sweep point of the calculated harmonic grid exceeds the maximum frequency of the analyzer, then an error message is displayed, and another harmonic grid algorithm must be used.
- Keep "Stop Freq, Approx Freq Gap" means that the stop frequency is maintained and the number of sweep points is increased until the range between  $f_{min}$  and the stop frequency is filled. The frequency gap is approximately maintained.

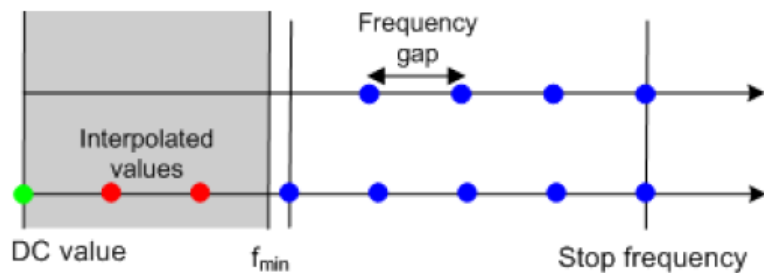

The figures above are schematic and do not comply with the conditions placed on the number of sweep points and interpolated/extrapolated values.



The harmonic grids cannot be calculated for any set of sweep points. If the minimum number of sweep points is smaller than 5, then the interpolation/extrapolation algorithm for additional sweep points does not work. The same is true if the number of sweep points or stop frequency exceeds the upper limit. Besides, the ratio between the sweep range and the interpolation range between  $f = 0$  and  $f = f_{min}$  must be large enough to ensure accurate results. If the sweep range for the harmonic grid exceeds the frequency range of the current system error correction, a warning is displayed.

### Finding the appropriate algorithm

The three types of harmonic grids have different advantages and drawbacks. Note that for a bandpass transformation the grid parameters have the following effect:

- A wider sweep range (i.e. a larger bandwidth) increases the time domain resolution.
- A smaller frequency gap extends the unambiguous range.
- A larger number of points increases the sweep time.

With default analyzer settings, the differences between the grid types are small. The following table helps you find the appropriate grid.

**Table 8-3: Properties of grid types**

Grid type: Keep	Sweep time	Time domain resolution	Unambiguous range	Algorithm fails if...
"Stop Freq, Nr. Of Points"	➡	⬆	⬇	-
"Freq Gap, Nr. Of Points"	➡	➡	➡	Stop frequency beyond upper frequency limit
"Stop Freq, Approx Freq Gap"	⬆	⬆	➡	Number of sweep points beyond limit

1. Press "FREQ/DIST"
2. Select "Time Domain" softkey.  
The R&S ZNH displays a submenu to select the time domain settings.
3. Select "Low Pass Config" to display the "Low Pass" dialog.  
The "Is Harmonic Grid" indicates whether the current frequency grid is harmonic. If using a "Low Pass" transformation and the "Is Harmonic Grid" is Off, trigger one of the harmonic grid algorithms in the "Keep Constant" or set the "Auto Harmonic" grid to "On".

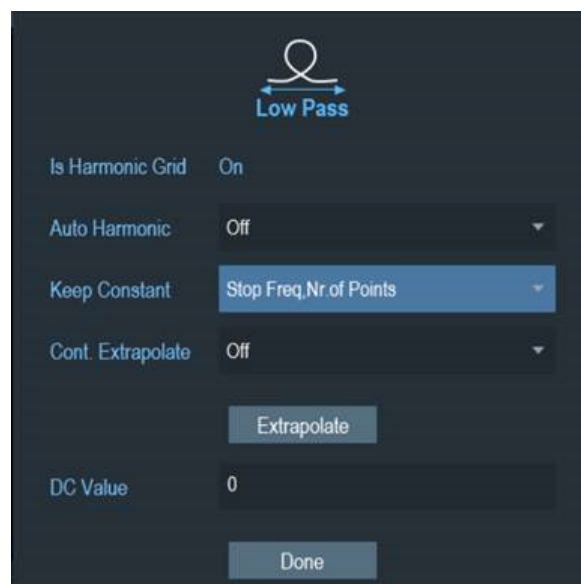

**Figure 8-11: Low pass config dialog**

4. Depending on the "Is Harmonic Grid", set the "Auto Harmonic" accordingly.  
If set "On", the frequency grid is automatically kept harmonic.
5. Select the "Keep Constant" to set algorithm for calculation of harmonic grid.
  - "Freq Gap, Nr. Of Points": Calculates a harmonic grid based on the current number of points and the current frequency gap / frequency step size.



- "Stop Freq, Nr. Of Points": Calculates a harmonic grid based on the current "Stop Frequency" and increasing the number of points in such a way that the frequency gap / frequency step size remains approximately the same.
  - "Stop Freq, Nr. Of Points": Calculates a harmonic grid based on the current "Stop Frequency" and the current number of points.
6. Set the "Cont. Extrapolate" and "DC Value" accordingly.  
To set the DC Value at zero frequency, this section is only available after a harmonic grid is established.  
If the properties of the DUT at  $f = 0$  are sufficiently known, it is recommended to manually set the "DC Value", e.g. at  $f = 0$ , the DC value for an open ended cable is 1, for a short-circuited cable is -1, and for cable with a matched termination is 0.
- "Cont. Extrapolate": Initiates a continuous extrapolation of the measured trace towards  $f = 0$ . The extrapolation is repeated after each sweep.
  - "Extrapolate": Initiates an extrapolation of the measured trace towards  $f = 0$  and overwrites the current DC value. This function can be used for a consistency check.

#### 8.3.5.4 Time gates

A time gate is used to eliminate unwanted responses that appear on the time domain transform. An active time gate acts on the trace in time domain and in frequency domain representation.

The properties of the time gates are analogous to the properties of the frequency domain windows. See [Table 8-4](#).

**Table 8-4: Properties of time gates**

Window	Side lobe suppression	Passband ripple	Application
"Steepest Edges" (Rectangle)	13 dB	0.547 dB	Eliminate small distortions in the vicinity of the useful signal, if demands on amplitude accuracy are low
"Steep Edges" (Hamming)	43 dB	0.019 dB	Good compromise between edge steepness and side lobe suppression.
"Normal Gate" (Hann)	32 dB	0.032 dB	Good compromise between edge steepness and side lobe suppression
"Max Flatness" (Bohman)	46 dB	0 dB	Maximum attenuation of responses outside the gate span
"Arb Gate Shape" (Dolph-Chebyshev)	User defined between 10 dB and 120 dB	0.071 dB	Adjustment to individual needs; tradeoff between side lobe suppression and edge steepness

### Time-gated frequency domain trace

The trace in the frequency domain depends on the state of the "Time Gate":

- If the gate is disabled, the frequency domain (FD) trace corresponds to the measured sweep results before the time-domain transformation.
- If the gate is enabled, the displayed frequency domain trace is calculated from the time domain (TD) trace which is gated and transformed back into the frequency domain.

The R&S ZNH uses fixed **No Profiling (Rectangle)** window settings to transform the measured trace into time domain. The TD trace is gated using the selected **time gate**. The gated trace is transformed back into frequency domain using a **No Profiling (Rectangle)** window.

The shape, width and position of the time gate affect the gated frequency domain trace. The window type selection in the **time domain** dialog is ignored. The selected **impulse response window** is used again when the TD trace is displayed ("Time Domain" is enabled.).

The rectangular **No Profiling (Rectangle)** windows minimize numerical inaccuracies near the boundaries of the measured frequency span. In the limit where the effect of the time gate vanishes (e.g. a gate of filter type "Notch" and a very small width), the time gated trace is equal to the original measured trace.

1. Press "FREQ/DIST"
2. Select "Time Domain" softkey.  
The R&S ZNH displays a submenu to select the time domain settings.
3. Select "Time Gate" to enable the time gated measurement in the time domain and frequency domain traces.
4. Select "Time Gate Config" to display the "Time Gate" dialog.

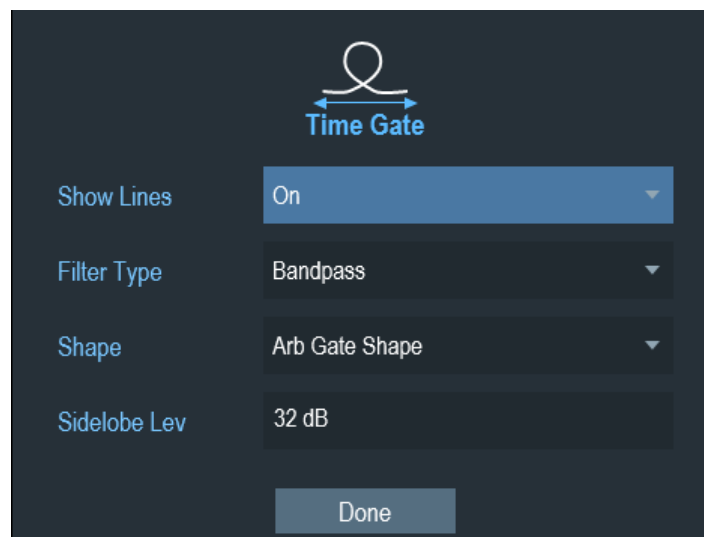

Figure 8-12: Time gate dialog

5. Select "Show Lines" to display the start and stop of the time gate in a time domain diagram.
6. Select the "Filter Type" to set type of filtering for gating function.
  - "Bandpass": Apply bandpass filter to pass all information in the specified time region and rejects everything else
  - "Notch": Apply notch filter to reject all information in the specified time region and passes everything else
7. Select the "Shape" to filter the trace in the time domain.  
For details, see [Table 8-4](#).
8. Set the "Time Gate Range" to define the time gate range for gating function.

## 8.4 Configuring vector network analysis

For valid measurement results, you need to specify the parameters to best display the characteristics of the measurements.

### 8.4.1 Configuring the horizontal axis

The [FREQ/DIST] key defines the frequency, span and signal standard on the horizontal axis of the measurements. When measurements are made in time domain, the [FREQ/DIST] key defines the time and distance of the measurements.

For more information on the settings of frequency, span and signal standard, see "[Setting the displayed frequency range](#)" on page 135, "[Defining the span](#)" on page 135 and [Chapter 7.2.2.4, "Selecting a signal standard for CAT measurements \(except DTF\)"](#), on page 136.

For more information on the settings of time or distance, see [Chapter 7.2.2.2, "Setting the start and stop distance for DTF measurements"](#), on page 135.

### 8.4.2 Configuring the vertical axis

Some results may not fit in the diagram area as it is configured in the default state of the R&S ZNH (e.g. measurement on amplifiers).

If you are performing measurements on an amplifier, you most likely have to change the scaling of the vertical axis in order to see the complete transmission function.

The R&S ZNH provides several ways to adjust the scaling of the vertical axis.

#### 8.4.2.1 Changing the reference value

Changing the reference value works like an attenuation or gain in that it moves the trace to another level. The R&S ZNH adjusts the scale of the vertical axis accordingly.

For more information, see [Chapter 7.2.3.1, "Setting the reference value"](#), on page 136.

#### 8.4.2.2 Defining the reference position

Changing the reference position moves the position of the reference value up or down. The reference position also moves the trace up or down. The levels and the reference value, however, remain the same. The default reference position is the grid line at the top of the diagram. The reference position is indicated by a triangle at the vertical axis .

The reference position is a number between 0 and 10 with 0 being the grid line at the bottom and 10 being the grid line at the top of the diagram.

For more information, see [Chapter 7.2.3.4, "Setting the reference position"](#), on page 137.

#### 8.4.2.3 Defining the display range

Changing the display range of the R&S ZNH modifies the value of the vertical axis of the measurement diagram of the selected trace.

For more information, see [Chapter 7.2.3.2, "Defining the display range"](#), on page 137.

#### 8.4.2.4 Adjusting the vertical axis automatically



##### Automatic scaling of the vertical axis

All measurement formats except the Smith chart feature an automatic scale function. If you use automatic scaling, the R&S ZNH automatically sets the display range in a way that the trace best fits on the display.

For more information, see [Chapter 7.2.3.3, "Adjusting the vertical axis automatically"](#), on page 137.

#### 8.4.2.5 Setting the port power and receiver attenuation

You can configure the "Port Power" to transmit a suitable signal source power into the DUT. Value can be adjusted from -25 dBm to 0 dBm in step of 1 dB. See also ["Defining the output level of the test port power \(tracking generator\)"](#) on page 154.

Beside adjusting the signal source power, you can adjust the receiver step attenuators to adapt the receiver signal level to the input level range of the analyzer. This helps to protect the instrument from being overloaded or damaged, i.e. if the DUT is a power amplifier. Attenuator factors are from 0 dB to 15 dB in steps of 5 dB.

1. Press the [SCALE/AMPT] key.
2. Select the "Port Config" softkey.  
The R&S ZNH opens a submenu to specify the power setting.

- "Port Power": Signal source power of the selected driving port setting.
  - "Rcv Attn Port1": Receiver step attenuator for port 1.
  - "Rcv Attn Port2": Receiver step attenuator for port 2.
  - "RF Off": Signal source is turned off.
3. The R&S ZNH displays an input field for signal source and receiver step attenuator settings.  
To turn off the signal source power, select "RF Off" from the menu item.

#### 8.4.2.6 Synchronizing trace settings

By coupling the trace settings together, you can align the vertical settings ([Ref Level](#), [Scale Range](#), [Ref Position](#), [Auto Scale](#)) of all measurement traces to the selected trace settings.

1. Select the [trace label](#) which vertical settings are to be aligned.  
The R&S ZNH highlights the trace label.
2. Press the [SCALE/AMPT] key.
3. Select the "Couple Traces" softkey.  
The R&S ZNH aligns the vertical settings of all display traces to the selected trace settings.

#### 8.4.3 Selecting the measurement format



Different trace formats allow you to express and display the results, depending on what you want to learn from the data. The R&S ZNH allows arbitrary combinations of display formats and [measured quantities](#). To extract useful information, it is important to select a display format which is appropriate to the analysis of a particular [measured quantities](#).

The following table gives an overview of the recommended display formats that is suited to the [measured quantities](#):

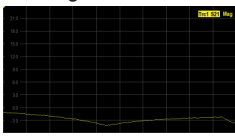
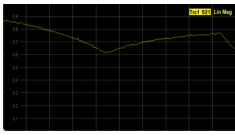
*Table 8-5: Recommendation of display format vs measured quantities*

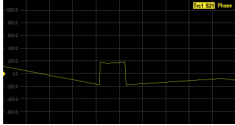
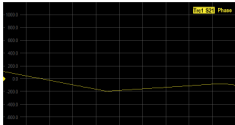
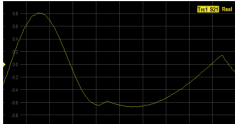
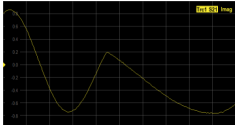
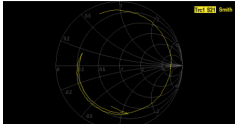
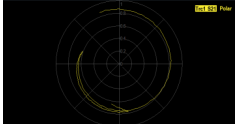
Measured quantities	Description	Complex dimensionless quantities: S-parameters and ratios	Complex quantities with dimensions: Wave quantities
Lin Mag 	Selects a Cartesian diagram with a linear vertical axis scale to display the magnitude of the measured quantity.	ON	ON
dB Mag 	Selects a Cartesian diagram with a dB scale of the vertical axis to display the magnitude of the complex measured quantity.	ON *(default)	ON *(default)

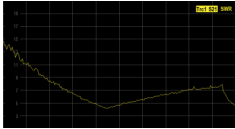
Measured quantities	Description	Complex dimensionless quantities: S-parameters and ratios	Complex quantities with dimensions: Wave quantities
Phase 	<p>Shows the phase characteristics of the DUT in degrees. The diagram is a Cartesian diagram with a linear vertical axis. The horizontal axis represents the measured frequency range.</p> <p>In the default state, the R&amp;S ZNH shows the phase only from <math>-200^{\circ}</math> to <math>+200^{\circ}</math>. In that case, the R&amp;S ZNH displays measurement results correctly only if the phase difference between two adjacent test points is less than <math>180^{\circ}</math>.</p>	ON	ON
Unwrapped phase 	<p>Unwrap the phase to expand the range of the phase.</p>	ON	ON
Real 	<p>Selects a Cartesian diagram to display the real part of a complex measured quantity.</p>	ON	ON
Imag 	<p>Selects a Cartesian diagram to display the imaginary part of a complex measured quantity.</p>	ON	ON
Smith 	<p>Selects a Smith chart to display a complex quantity, primarily a reflection S-parameter.</p> <p>The Smith chart is a circular diagram that primarily shows impedance or reflection characteristics of a DUT. In contrast to the polar diagram, the scaling of the diagram is not linear.</p>	ON (reflection coefficients $S_{ii}$ )	-
Polar 	<p>Selects a polar diagram to display a complex quantity, primarily an S-parameter or ratio.</p>	ON	-

Measured quantities	Description	Complex dimensionless quantities: S-parameters and ratios	Complex quantities with dimensions: Wave quantities
SWR 	Calculates the Standing Wave Ratio (SWR) from the measured quantity (typically a reflection S-parameter) and displays it in a Cartesian diagram.	ON (reflection coefficients $S_{ii}$ )	-
Group delay 	Calculates the (group) delay from the measured quantity (typically a transmission S-parameter) and displays it in a Cartesian diagram.  The group delay is a measure that describes the time period or delay of the signal as it goes through the DUT.	ON (transmission coefficients $S_{ii}$ )	-

\*The default formats are activated automatically when the [measured quantity](#) is changed.

1. Press the [FORMAT] key.  
The R&S ZNH displays available formats of the [measured quantity](#).
2. Select "More" to display more [measured quantity](#).
3. Select the required display formats according to [Table 8-5](#).
4. The marker also provides an extended range of measurement formats for trace measurements.  
To convert any point on a trace, create a marker and select the appropriate marker mode. Marker and trace can be applied independently.  
For more information, see [Chapter 8.5.2.2, "Marker modes"](#), on page 187.

#### Multiple displays of trace measurements

You can display and compare different measurement trace formats in a single or multiple measurement trace windows.

For multiple displays of measurement traces and measurement trace windows, see ["Multiple displays of measurement trace windows in VNA mode"](#) on page 34.

#### 8.4.4 Setting the sweep parameters

The [SWEEP] key allows you to define the scope and timing of the trace measurements.

- ▶ Press the [SWEEP] key.

The R&S ZNH displays the sweep functions for selection.

#### 8.4.4.1 Changing the number of measurement points

Sets the total number of measurement points per sweep. The minimum number of points is 3 (measurement at a single frequency/power/time value), the maximum is 16,001.

Increasing the number of sweep points improves the resolution of the trace but increases the measurement time. The overall measurement time is composed of the hardware settling time at the beginning of the sweep plus the sum of the measurement times at each individual sweep point. Hence the measurement time increases roughly linearly with the number of points.

1. Press the "Number of Points" softkey.  
The R&S ZNH opens an input field to define the measurement points.
2. Key in the required measurement points.

#### 8.4.4.2 Setting the measurement bandwidth

The measurement bandwidth determines the noise figure of the receiver. Small bandwidths result in higher measurement dynamics for trace measurements. However, small bandwidths cause longer measurement times because of the settling time of the filter.

1. Press the "Meas BW" softkey.  
The R&S ZNH opens an input field to define the measurement bandwidth.
2. Use the rotary knob to adjust the settings.

#### 8.4.4.3 Setting the sweep time

The measurement time is the total measurement time for the sweep. The minimum possible sweep time is equal to the estimated value in the "Auto" mode which value is defined by the [measurement points](#) and [measurement bandwidth](#).

Possible bandwidths are between 10 Hz, 30 Hz, 100 Hz, 300 Hz, 1 kHz, 3 kHz, 10 kHz, 30 kHz, 100 kHz.

1. Press the "Sweep" softkey.  
The R&S ZNH opens a submenu to define the sweep time.
  - Auto: Default setting for the sweep time.
  - Manual: Manual value keyed-in for the sweep time. Value lesser than "Auto" mode is reverted to "Auto" value.
2. Select the required setting.



#### 8.4.4.4 Setting the triggering measurements

In the default state, the R&S ZNH starts a measurement on completion of the previous measurement ("Free Run" measurements).

However, for measurements perform under certain signal conditions, you can use the triggering function. A trigger responds to certain events. If a trigger is active, the R&S ZNH starts to measure if the trigger conditions are met. The trigger can be generated either externally or internally.

1. Press the "Trigger" softkey.

The R&S ZNH opens a submenu to select the trigger source.

- "Free Run": A new sweep starts on completion of the previous sweep. This is the default state of the R&S ZNH.
- "External Rise" / "External Fall": A sweep starts on the rising edge ("Rise") or on the falling edge ("Fall") of an external trigger signal. The external trigger signal is fed in via the [BNC connector](#). The switching threshold is 1.4 V, i.e. a TTL signal level.
- "Trigger Delay": When applying an external trigger, a delay at the start of the measurement with respect to the trigger event by entering a delay time. In this way, a time difference between the trigger event and the measurement can be included.

The range of the trigger delay is from 0 us to 100 s. The resolution depends on the subrange.

- 0 ms to 1 ms - 10 us resolution
- 1 ms to 10 ms - 100 us resolution
- 10 ms to 100 ms - 1 ms resolution
- 100 ms to 1 s - 10 ms resolution
- 1 s to 10 s - 100 ms resolution
- 10 s to 100 s - 1 s resolution

2. Select the trigger source you need.

The R&S ZNH activates the trigger.

#### 8.4.4.5 Selecting the sweep mode

The R&S ZNH provides single sweep and continuous sweep to perform measurement.

For more information, see [Chapter 7.2.6.1, "Selecting the sweep mode"](#), on page 139.

## 8.5 Analyzing measurement results

The following sections describe how you can work with traces and use markers, limit lines and display line to analyze your measurement result.

## 8.5.1 Working with traces

When working with traces, it is important to select the right [trace label](#) to work with.

- ▶ Press the [TRACE] key.  
The R&S ZNH displays the trace functions for selection.

### 8.5.1.1 Number of traces

You can add up to four measurement traces in all display measurement trace windows. For more information, see [Chapter 4.1.4, "Measurement trace window"](#), on page 33.

1. Select "New Trace" to add a new measurement trace on the selected measurement trace window.
  - "Add Trace": A default "S21" measurement with "dB Mag" trace format is added.
  - "Add Trace + Disp": A new trace is added to a new measurement trace window.
2. Select "Delete Trace" to delete the selected trace.  
The R&S ZNH opens a submenu to delete the trace measurement.
  - "Delete Selected": The selected trace measurement is deleted.  
If the selected trace is the only trace in the measurement trace window, the affected measurement trace window will be removed.  
Note: "Trc1" measurement is not removable.
  - "Delete All": All traces except "Trc1" are deleted from the display measurement trace windows.
3. Delete the required trace.

### 8.5.1.2 Selecting the trace mode

The R&S ZNH provides two trace modes to write the trace: "Average On" and "Average Off".

For more information, see [Chapter 7.3.1.1, "Setting the trace mode"](#), on page 140.

### 8.5.1.3 Selecting suppressing interfering signals

The selection of suppressing interfering signals affect all the display trace measurements.

For more information, see [Chapter 7.3.1.2, "Suppressing interfering signals"](#), on page 141.

### 8.5.1.4 Working with memory traces

The R&S ZNH supports a total of four measurement traces and each trace can be transferred to the trace memory for comparison.

For more information, see [Chapter 7.3.1.3, "Working with memory traces"](#), on page 141.

#### 8.5.1.5 Using trace mathematics

Trace mathematics that subtract one trace from another are available for most measurement formats in the network analyzer mode.

For more information, see [Chapter 7.3.1.4, "Using trace mathematics"](#), on page 142.

### 8.5.2 Using markers

The marker allows you to make measurement points on a trace, define their properties and as a searching tool for searching special points on traces.

The marker also provides function to extend output formats for trace measurements, see [Chapter 8.5.2.2, "Marker modes"](#), on page 187.

#### 8.5.2.1 Using markers and deltamarkers

Numerical results of the marker and deltamarker are displayed in the measurement result view.

For more information on using markers and deltamarkers, see [Chapter 7.3.2.1, "Using markers and deltamarkers"](#), on page 142.

#### 8.5.2.2 Marker modes

In addition to the standard marker functionality, the "Marker Modes" extended the trace measurement output formats.

1. Press the [MARKER] key.  
If no marker has been activated, the R&S ZNH automatically activates the main marker and positions it on the maximum level that has been measured. In addition, the marker frequency input field opens.
2. Select "Marker Mode"  
The R&S ZNH opens a submenu to select the marker output formats.  
For a list of the output format, see [Table 7-1](#).
3. Select the required output format.

#### 8.5.2.3 Marker coupling

The R&S ZNH allows you to compare different measurement results (assigned to different measurement traces) using the same marker.

When marker coupling is active, the marker sets of the related traces are always kept in sync, i.e.:

- If a marker is added to (removed from) one of the related traces, it is also added to (removed from) the other related traces.
- If a marker is moved to a particular stimulus value for one of the related traces, then it is moved to this stimulus value for all related traces.

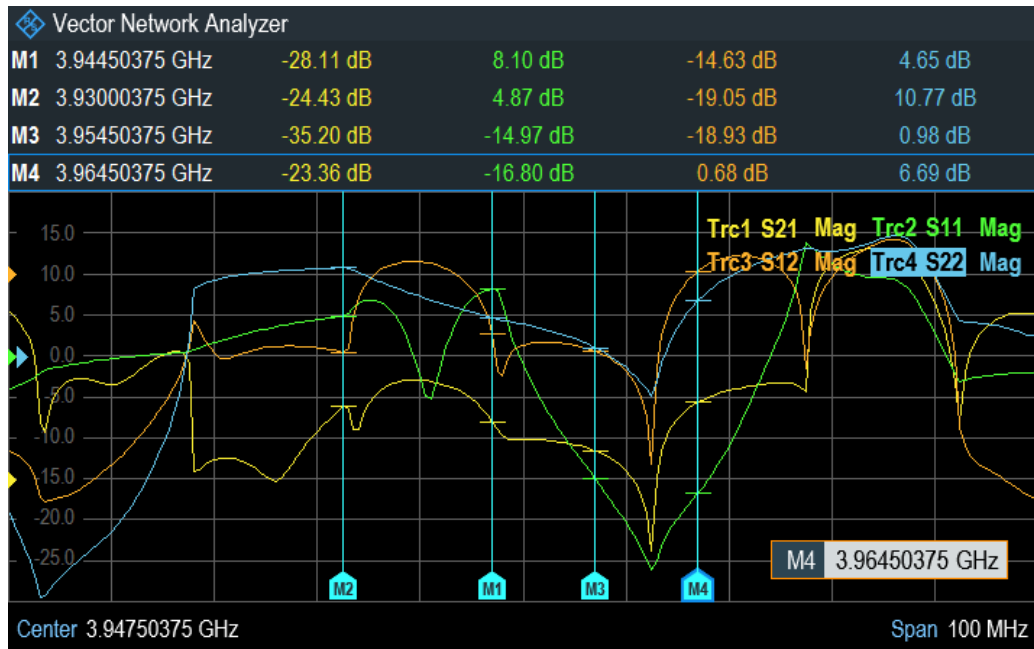

1. Press the [MARKER] key.  
If no marker has been activated, the R&S ZNH automatically activates the main marker and positions it on the maximum level that has been measured. In addition, the marker frequency input field opens.
2. Select "Set Marker" softkey.  
The R&S ZNH opens a submenu to set marker coupling.
3. Enable the marker coupling checkbox.

### 8.5.3 Using display lines

A display line is a straight line that runs horizontally and corresponds to a certain level value on the measurement trace window.

For more information, see [Chapter 7.3.3, "Using display line"](#), on page 148.

### 8.5.4 Using limit lines

When working with the magnitude format in the network analyzer, you can use limit lines to set limits for level characteristics on the display that must not be exceeded.

You can create and edit limit lines with the R&S InstrumentView software and load them into the R&S ZNH via the USB or the LAN interface. The number of limit lines the

R&S ZNH can store in its memory depends on the number of other data sets on the R&S ZNH

For more information, see [Chapter 7.3, "Analyzing measurement results"](#), on page 140.

## 9 Vector voltmeter



### R&S ZNH option

R&S ZNH-K45 (order number 1334.6852.02) option is required to operate the R&S ZNH in the vector voltmeter mode.

Equipped with R&S ZNH-K45, you can use a R&S ZNH with tracking generator and VSWR bridge as a vector voltmeter.

A vector voltmeter performs reflection (S11) and transmission measurements (S21). The tracking generator provides the signal source that generates an unmodulated sine-wave signal on a single frequency. Typical applications for a vector voltmeter are:

- adjustment of the electrical length of cables with a reflection measurement
- testing of the antenna elements of a phase-controlled antenna-array relative to a reference antenna with a transmission measurement

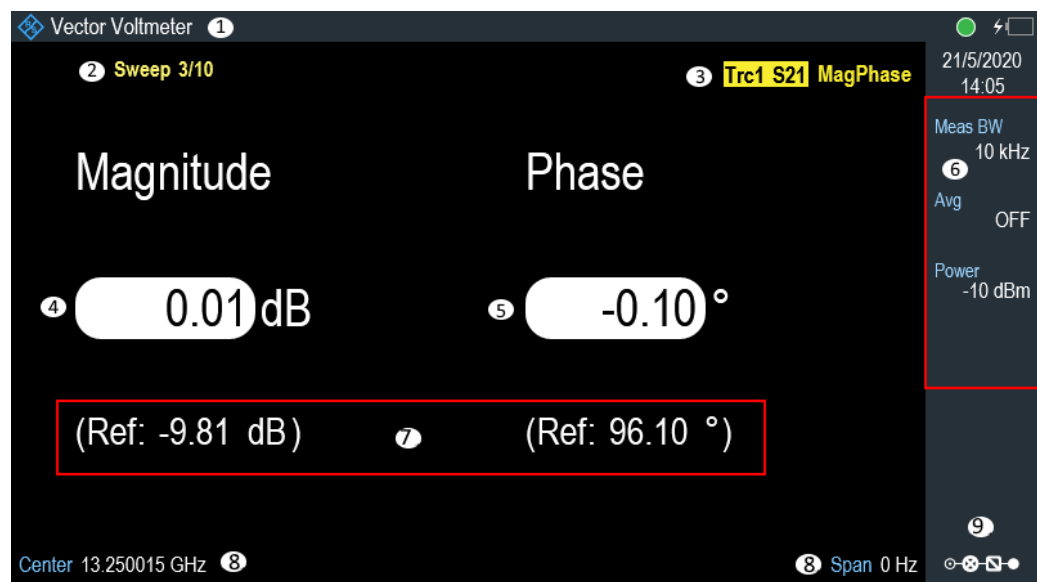

**Figure 9-1: Screen layout of vector voltmeter**

- 1 = Vector voltmeter measurement mode
- 2 = Counter value when averaging measurement is performed
- 3 = [Trace label](#)
- 4 = If "> Ref" is enabled, the magnitude result displays the difference of current measurement and the display reference value. The above screen layout shows -9.80 dB if "> Ref" is disabled. See [Chapter 9.3, "Analyzing measurement results"](#), on page 192.
- 5 = If "> Ref" is enabled, the phase result displays the difference of current measurement and the display reference value. The above screen layout shows 96.00 ° if "> Ref" is disabled. See [Chapter 9.3, "Analyzing measurement results"](#), on page 192.
- 6 = [Parameter view](#)
- 7 = Display reference of the measurements
- 8 = [Center frequency](#) of the measurements in 0 Hz span (time domain)
- 9 = [Config Overview](#)

1. Press the MODE key.
2. Press the "Vector Voltmeter" softkey.  
The R&S ZNH starts the vector voltmeter mode. It turns on the tracking generator and the zero span mode.

## 9.1 Calibrating measurements

To get the best and most accurate results, you have to calibrate the measurement. The reflection and transmission measurement of the vector voltmeter each have their own calibration procedures. To successfully calibrate the test setup, you have to connect one or more calibration standards at the reference plane.

The process of calibration including the selection of a calibration kit works like that for scalar or vector measurement. For calibration to remain valid, the frequency, bandwidth and attenuation have to remain the same during the measurement.

Reconnect the DUT after the calibration, see [Table 9-1](#) for the recommended calibration methods used for S21 and S11 measurements.

For more information, see [Chapter 8.1, "Calibrating measurements"](#), on page 154.

**Table 9-1: Recommended calibration methods**

Calibration method	Measurement
<a href="#">TOSM or UOSM</a>	Transmission measurement, S21
<a href="#">Refl OSM</a>	Reflection measurement, S11

## 9.2 Performing voltmeter measurements

With the vector voltmeter, you can measure the reflection on port 1 and the transmission in reverse direction.

### Select the type of reflection measurement

1. Press the [MEAS] key.  
The R&S ZNH displays the measurement softkeys for selection.
  - "S11": Reflection measurement on port 1
  - "S21": Transmission measurement in reverse direction
  - "> Ref": Reference result for future measurements
2. Select the required measurements.

### Define the frequency parameters

Before calibrating the measurement, you should define the frequency parameters to avoid interpolation of the results.

1. Press the [FREQ/DIST] key.  
The R&S ZNH opens an input field to set the center frequency.
2. Enter the required frequency.

#### Define the power

It is important not to overload at the RF input. Supply a suitable signal source and attenuate the receiving power depending on the DUT characteristics.

1. Press [SCALE/AMPT] key.
2. Select "TG Power" to set the output signal source.  
The R&S ZNH opens an input field to set the tracking generator power.
3. Set the required power level.
4. Select "Receiver Att" to attenuate the receiving power at the RF input.  
The R&S ZNH opens an input field to attenuate the receiving power at the RF input of R&S ZNH.
5. Set the required attenuation level.

#### Setting the trace mode

For more information, see [Chapter 8.5.1.2, "Selecting the trace mode"](#), on page 186.

#### Setting the sweep parameters

For more information to set measurement bandwidth, signal triggering, sweep mode, see respective section in [Chapter 7.2.6.1, "Selecting the sweep mode"](#), on page 139.

For more information to set measurement hold, see [Chapter 7.2.6.3, "Measurements hold"](#), on page 140.

## 9.3 Analyzing measurement results

If you perform measurements on different DUTs whose results you would like to compare, you can save the current results as reference values.

1. Press the [MEAS] key
2. Press the "> Ref" softkey.  
The R&S ZNH saves the results as the reference result for future measurements.  
The magnitude and phase results displayed show the difference of the current measurement and the reference measurement. The unit for reference measurement is always dB. For more information, see [Figure 9-1](#).



## 10 Power meter



### R&S ZNH option

R&S ZNH-K9 (order number: 1334.6800.02) option is required to operate the R&S ZNH in the power meter mode.



### Signal source output

When the "Signal Gen" softkey is activated, the R&S ZNH provides a signal source which you can use to perform a quick cable loss measurement on DUT. See "[Activating signal source](#)" on page 198.

For highly accurate power measurements, you can connect a power sensor to the R&S ZNH and perform measurements.

- [Using a power sensor](#)..... 193
- [Using a directional power sensor](#)..... 198

### 10.1 Using a power sensor

The power sensor function turns the R&S ZNH into a wideband power meter. It then always measures the power of the whole signal in the frequency range of the power sensor. In most cases, the signal shape has no effect on the measurement.

The power sensor measures the power in the frequency range defined in the data sheet of the power sensor. This means that you can measure both sine signals and modulated signals precisely over a large dynamic range.

For a complete list of supported power sensors, refer to the data sheet.

If you are using one of the NRP power sensors, you also need a passive USB adapter (R&S NRP-Z4) to connect the power sensor to the R&S ZNH.

For more information on the characteristics of the supported power sensors, see the following:

- The datasheet of the R&S ZNH.
- The website for R&S power sensors.

[http://www.rohde-schwarz.com/en/products/test\\_and\\_measurement/power\\_volt\\_meter/NRPZ.html](http://www.rohde-schwarz.com/en/products/test_and_measurement/power_volt_meter/NRPZ.html)

1. Press [MODE] key.
2. Select "Power Meter" softkey  
The R&S ZNH activates the mode for power meter measurement.

3. If R&S K-69 option is installed, you can activate the power meter measurement with "Meas Mode > Average" menu item. For more information, see [Chapter 12, "Performing Frequency Conversion Power Measurements"](#), on page 211.

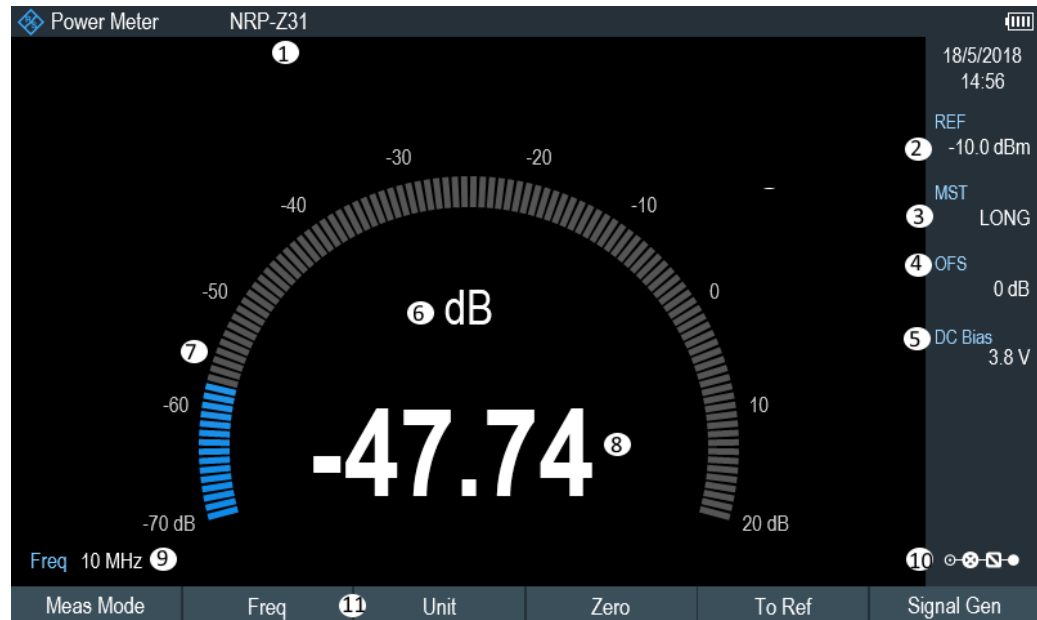

**Figure 10-1: Screen layout of the power meter mode**

- 1 = Connected power sensor model
- 2 = Reference for relative power measurements
- 3 = Measurement time
- 4 = Power offset
- 5 = ["Configuring the BIAS output port"](#) on page 41
- 6 = Power measurement unit
- 7 = Analog readout of the measured power
- 8 = Readout of the measured power
- 9 = Measurement frequency
- 10 = Configuration overview icon
- 11 = Power sensor softkey menu

### 10.1.1 Connecting a power sensor

The R&S ZNH controls and powers the power sensors via the USB interface on the top of the instrument. See ["USB type A connector"](#) on page 27.

If you are using the R&S FSH-Z1 and R&S-FSH-Z18 power sensors, connect the power sensor cable to the FSH-Z144 (USB to binder adapter) before connecting it to the USB interface of the R&S ZNH.

For the test setup of the power sensor, see ["Test setup"](#) on page 67.

After connecting the power sensor to the R&S ZNH, you can connect the DUT to the N-connector of the power sensor.

**NOTICE****Risk of damage to the power sensor**

Before you start to work with the power sensor, make sure that the continuous power applied to the input of the power sensor does not exceed a certain level.

Refer to the documentation of the power sensor for more information on the maximum input power.

If the R&S ZNH recognizes a power sensor, it sets up a connection via the interface and after a few seconds shows the measured power. It displays the type of the power sensor in the display header.

If no power sensor has been connected or it is not connected appropriately, the R&S ZNH shows nothing.

If there are communication problems between the R&S ZNH and the power sensor, the R&S ZNH displays one of the following error messages that indicate the possible cause.

**Table 10-1: Error message for power sensor**

Message	Cause	Remedy
Error in zeroing: signal at sensor	A signal was present at the power sensor when zeroing was performed.	Unscrew the power sensor from the device under test and repeat zeroing.
Warning: Input overloaded	The power at the input of the power sensor exceeds the permitted power (23 dBm = 200 mW).	Reduce the power at the sensor input.
Power sensor hardware error	Communication error between the R&S ZNH and the power sensor.	Unscrew the sensor from the R&S ZNH and check the connectors.  If the problem persists, contact a Rohde & Schwarz service center.
Power sensor error	The power sensor signals an error to the R&S ZNH	Contact a Rohde & Schwarz service center.
Unknown power sensor model connected	The R&S ZNH cannot identify the device connected to the power sensor interface.	

### 10.1.2 Performing and configuring measurements

After you have connected a power sensor, the R&S ZNH immediately starts to measure the signal power.

#### Defining the center frequency or wavelength

Power sensors have a memory containing correction values that are dependent on the frequency or wavelength. Hence, measurement results are the most accurate for signals whose frequency or wavelength you know.

### Center frequency

Note that the R&S ZNH maintains the center frequency that you have set in another operating mode. In that case, it uses that frequency as the power sensor frequency.

If you want to perform measurements on another known signal, you can change the power sensor frequency manually.

1. Select "Freq" softkey.  
The R&S ZNH opens an input field to define the frequency.
2. Enter the frequency of the signal.  
The R&S ZNH transfers the new frequency to the power sensor which then corrects the measured power readings.

### Wavelength

Wavelength is typically used in the measurement result for optical power sensor measurement. The R&S ZNH supports the wavelength: 850 nm, 1300 nm, 1310 nm, 1490 nm, 1550 nm, 1610 nm, 1625 nm for measurement.

1. Select "wavelength" softkey.  
The R&S ZNH opens a submenu for the selection of wavelength settings.
2. Select the required wavelength for measurement.  
The R&S ZNH transfers the new wavelength to the power sensor which then corrects the measured power readings.

### Zeroing the power sensor

Offset voltages and currents have most effect on the power readout when measuring low powers. You can compensate for these offsets by zeroing the power sensor.

Do not apply power during the zeroing process, as the power sensor cannot distinguish between external powers and internal offsets.

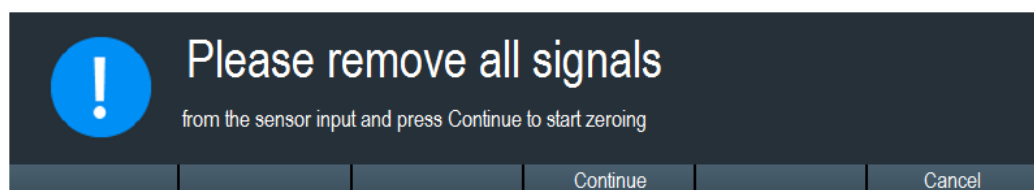

1. Select "Zero" softkey.
2. The R&S ZNH asks you not to apply any signals to the power sensor during the zeroing process.
3. Disconnect the power sensor from any signal sources.
4. Select "Continue" softkey to start zeroing.
5. Select "Cancel" softkey to abort zeroing, for example, if you cannot disconnect the signal source.

The R&S ZNH immediately starts power sensor zeroing.

While zeroing is in progress, the R&S ZNH shows the message "Zeroing power sensor, please wait while the system is zeroing the power sensor".

When zeroing is over, the R&S ZNH displays the message "✓ Power sensor zero done".



Power sensor zero done

### Selecting the unit for the power readout

The R&S ZNH can display measured power in relative units (dBm) or in absolute units (W, mW,  $\mu$ W, nW and  $\rho$ W). It is also possible to set a reference level in dB.

1. Select "Unit" softkey.  
A submenu to select the unit opens.
2. Select the unit you require.  
The R&S ZNH adjusts the result display accordingly.

### Setting the reference level

If you have selected the unit dB Rel, the R&S ZNH opens an input field to set the reference level. The R&S ZNH shows the currently set reference level in the diagram header.

1. Enter the reference level you require.  
Alternatively, you can set the current level readout as the reference level.
2. Select "To Ref" softkey.  
The R&S ZNH sets the current result as the reference level.  
It then displays the measured level relative to the reference level in dB. The unit is automatically set to dB Rel.

### Setting the averaging time

The averaging time determines the length of the measurement. The longer the averaging time, the more stable the display, particularly if signals have low power or are noisy.

The averaging time is either "Short", "Normal" or "Long".

- A short measurement time provides stable and accurate results for stationary sine signals with high levels ( $> -40$  dBm). It is also appropriate for measurements that require a high repetition rate.
- A normal measurement time increases the stability of results for signals with low levels or modulated signals.
- A long measurement time is appropriate for signals with very low-power levels ( $< -50$  dBm)

To eliminate noise and the effects of noise on the measurement effectively, use the R&S FSH-Z1 power sensor.

1. Select "MeasTime" softkey.
2. Select the measurement time most suitable for your test setup.

#### Taking additional loss or gain into account

At high powers that cause the power sensor maximum input level to be exceeded or at very low levels that are below the R&S ZNH minimum sensitivity, the R&S ZNH can take additional loss or gain between the DUT and the power sensor into account. These differences are defined in terms of an offset in dB relative to the measured level. A positive offset corresponds to a loss and a negative offset corresponds to a gain.

The R&S ZNH shows the current offset in the diagram header.

1. Select "OFS" softkey.  
The R&S ZNH opens an input field to define the reference offset.
2. Enter the offset you require.  
The R&S ZNH takes the offset value into account in the power or level display.

#### Activating signal source

The R&S ZNH provides the setting to enable or disable the built-in signal source in the power meter mode.

Once the signal source is enabled, you can output a signal source of -10 dBm at the designated frequency from the RF output connector.

- Select "Signal Gen" softkey.  
The R&S ZNH output a signal source of -10 dBm at the RF output connector.

## 10.2 Using a directional power sensor

For power measurements in both directions (forward and reverse), you can connect directional power sensors to the R&S ZNH. The R&S ZNH supports the following directional power sensors:

- R&S FSH-Z14
- R&S FSH-Z44

With a directional power sensor, the R&S ZNH measures the power of a signal from source to load (forward power) and from load to source (reverse power). The ratio of forward and reverse power is a measure of the load matching. The R&S ZNH displays the results as the return loss or the standing wave ratio.

1. Press [MODE] key.
2. Select "Power Meter" softkey  
The R&S ZNH activates the mode for power measurements.

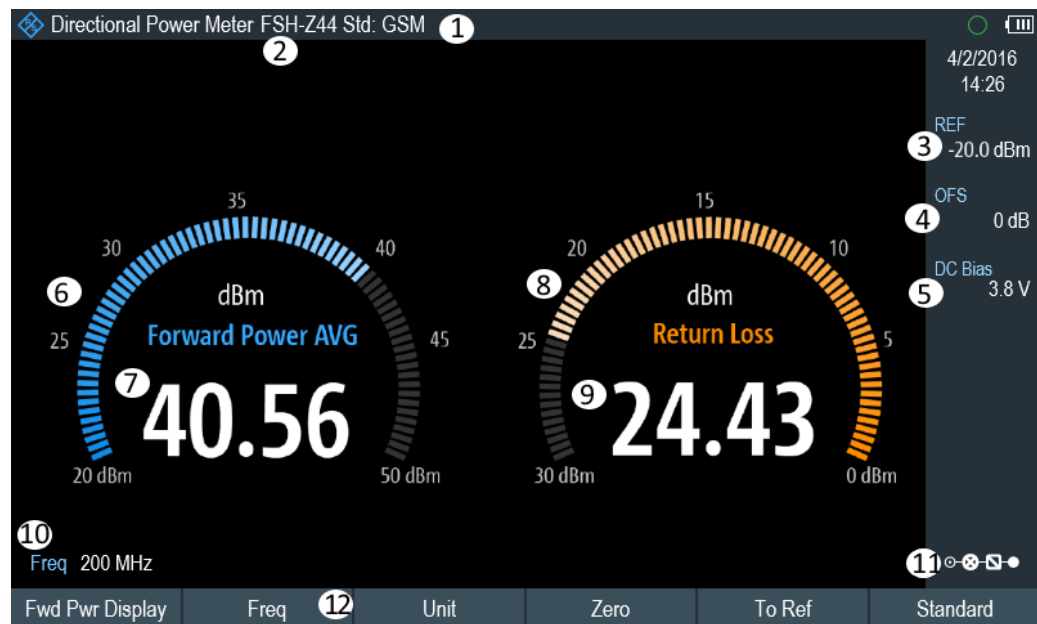

**Figure 10-2: Screen layout of the directional power mode**

- 1 = Selected transmission standard
- 2 = Connected power sensor model
- 3 = Reference for relative power measurements
- 4 = Power offset
- 5 = "Configuring the BIAS output port" on page 41
- 6 = Analog readout of the forward power
- 7 = Readout of the forward power
- 8 = Analog readout of the matching value
- 9 = Readout of the matching value
- 10 = Measurement frequency
- 11 = Configuration overview icon
- 12 = Directional power sensor "MEAS" softkey menu

## 10.2.1 Connecting a directional power sensor

The R&S ZNH controls and powers the directional power sensors via a special interface on the top of the instrument.

Connect the power sensor cable via the USB to binder adapter to the USB port of R&S ZNH. The power sensor itself is located between the source and the load of the test setup.

For the test setup of the directional power sensor, see "Test setup" on page 67.

If the R&S ZNH recognizes a power sensor, it sets up a connection via the interface and after a few seconds shows the results. It displays the type of the power sensor in the display header. If an error occurs, the R&S ZNH shows a corresponding message.

For more information, see [Chapter 10.1.1, "Connecting a power sensor"](#), on page 194.

## 10.2.2 Performing and configuring measurements

After you have connected a power sensor, the R&S ZNH immediately starts to measure the signal power.

When measuring high powers, pay strict attention to the following instructions to avoid personal injury and to prevent the power sensor from being destroyed.

### CAUTION

#### **Risk of skin burns and / or damage to the R&S ZNH**

Measuring high powers may lead to skin burns and / or damage to the R&S ZNH. You can avoid it by:

- Never exceeding the permissible continuous power. The permissible continuous power is indicated on a diagram on the back of the power sensor.
- Turning off the RF power when connecting the power sensor.
- Connecting the RF connectors tightly.

#### **Defining the center frequency**

To get the most accurate results, you should synchronize the frequency to that of the signal.

Note that the R&S ZNH maintains the center frequency that you have set in another operating mode. In that case, it uses that frequency as the power sensor frequency.

If you want to perform measurements on another known signal, you can change the power sensor frequency manually.

1. Select "Freq" softkey.  
The R&S ZNH opens an input field to define the frequency.
2. Enter the frequency of the signal.  
The R&S ZNH transfers the new frequency to the power sensor which then corrects the measured power readings.

#### **Zeroing the power sensor**

For more information, see ["Zeroing the power sensor"](#) on page 196.

#### **Setting the power measurement weighting mode**

For forward power display, the R&S ZNH provides both average power and peak envelope power.

1. Press [MEAS] key.
2. Select "FwrD Pwr Display" softkey.
3. Select the weighting mode you require.  
The R&S ZNH indicates the weighting mode at the forward power heading.



- "Average" = average power
- "Peak Envelope" = peak envelope power

### Selecting the unit for the power readout

When using a directional power sensor, the R&S ZNH displays the forward power as a logarithmic level value in dBm (relative value) or as a linear value in W or mW (absolute value). In addition, you can define a reference level relative to which the R&S ZNH indicates the level difference in dB. Load matching is indicated as return loss in dB or as voltage standing wave ratio (VSWR). In addition, the absolutely reflected power can be displayed in W, or the reflected level in dBm.

For more information, see ["Selecting the unit for the power readout"](#) on page 197.

### Setting the reference level

If you have selected the unit dB Rel for the forward power, the R&S ZNH opens an input field to set the reference level. The R&S ZNH shows the currently set reference level in the diagram header.

For more information, see ["Setting the reference level"](#) on page 197.

### Selecting a standard

To ensure that true results are output when measuring modulated signals, the R&S ZNH offers the possibility of taking correction values into account for several common telecommunications standards.

1. Select "Standard" softkey.  
A menu to select a standard opens.
2. Select the standard you require.  
The R&S ZNH takes the selected standard into account. The currently active standard is displayed in the display header.

### Taking additional attenuation into account

When the directional power sensor is connected to a test point not directly but via a cable, the influence of cable attenuation can be taken into account. For this purpose, the cable attenuation for the measurement frequency in question is to be entered is based on the following condition:

Condition for setting cable attenuation

- As a positive dB value if the power and matching are to be measured at the source and the cable is connected between the source and the power sensor
- As a negative dB value if the power and matching are to be measured at the load and the cable is connected between the load and the power sensor

The directional power sensor then corrects the power and matching values to produce the results that would have been obtained if it had been directly connected to the test point.

1. Select "OFS" softkey.

The R&S ZNH opens an input field to define the reference offset.

2. Enter the offset you require.

The R&S ZNH takes the offset value into account in the power (level) and matching results.

If high powers are applied that exceed the maximum input level of the R&S FSH-Z14 or R&S FSH-Z44, a directional coupler or an attenuator has to be connected ahead of the power sensor.

In such cases, the coupling attenuation of the directional coupler or the attenuation value of the attenuator are entered as positive dB values (see [condition to set cable attenuation](#)) into the R&S ZNH to ensure true measured power readout. In both cases, a termination or an attenuator of sufficient power-handling capacity has to be connected to the power sensor at the load end. The matching readout is irrelevant in such case since it is likewise corrected by taking into account the attenuation value of the termination or attenuator.

# 11 Performing pulse power measurements



## R&S ZNH option

R&S ZNH-K29 (order number: 1334.6823.02) option is required to operate the R&S ZNH in the pulse power meter mode.

When you equip the R&S ZNH with the pulse power measurement option and connect one of the wideband power sensors available from Rohde & Schwarz (R&S NRP-Z81, -Z85 or -Z86), you can perform pulse power measurements with your R&S ZNH.

Like the normal power meter application, the pulse power application measures the power of the whole signal in the frequency range of the (wideband) power sensor.

1. Press [MODE] key.
2. Select "Power Meter" softkey  
The R&S ZNH activates the mode for power measurements.

## Connecting the power sensor

You can connect the wideband power sensors to the USB port of the R&S ZNH. For more information, see [Chapter 10.1.1, "Connecting a power sensor"](#), on page 194.

The measurement starts as soon as the power sensor is connected.

## Numerical result display

1. Press [MEAS] key.
2. Select "Meas Mode" softkey.
3. Select the "Average" menu item.

The layout and contents of the numerical result display are the same as those described in [Figure 10-1](#).

## Graphical result display (Power vs Time)

The graphical representation of the results is a special feature only available with the firmware option R&S ZNH-K29.

1. Press [MEAS] key.
2. Select "Meas mode" softkey.
3. Select the "Power vs Time" menu item.

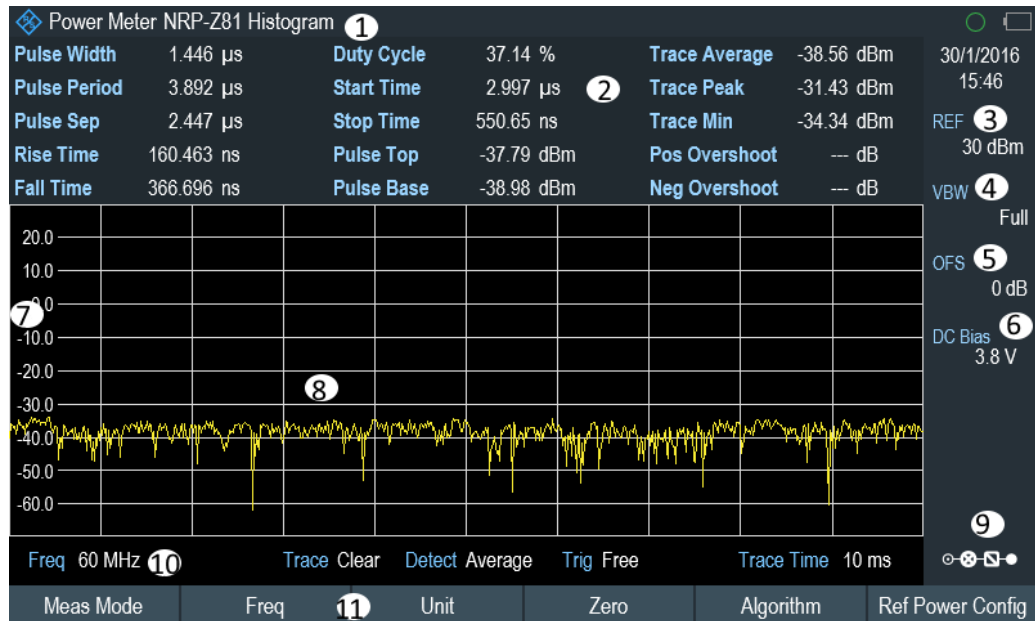

**Figure 11-1: Power vs time display**

- 1 = Connected power sensor model and type of algorithm for power calculation
- 2 = Numerical results showing the pulse characteristics
- 3 = Reference for relative power measurements
- 4 = Video bandwidth
- 5 = Power offset
- 6 = [Configuring the BIAS output port](#)
- 7 = Scale of the x-axis
- 8 = Diagram showing the pulse characteristics in a graphical format (trace display)
- 9 = Configuring overview icon
- 10 = Measurement frequency
- 11 = Softkey menu of the pulse power measurement application

The following power characteristics are calculated and displayed as numerical values. See [Figure 11-2](#) for a graphical representation of the parameters.

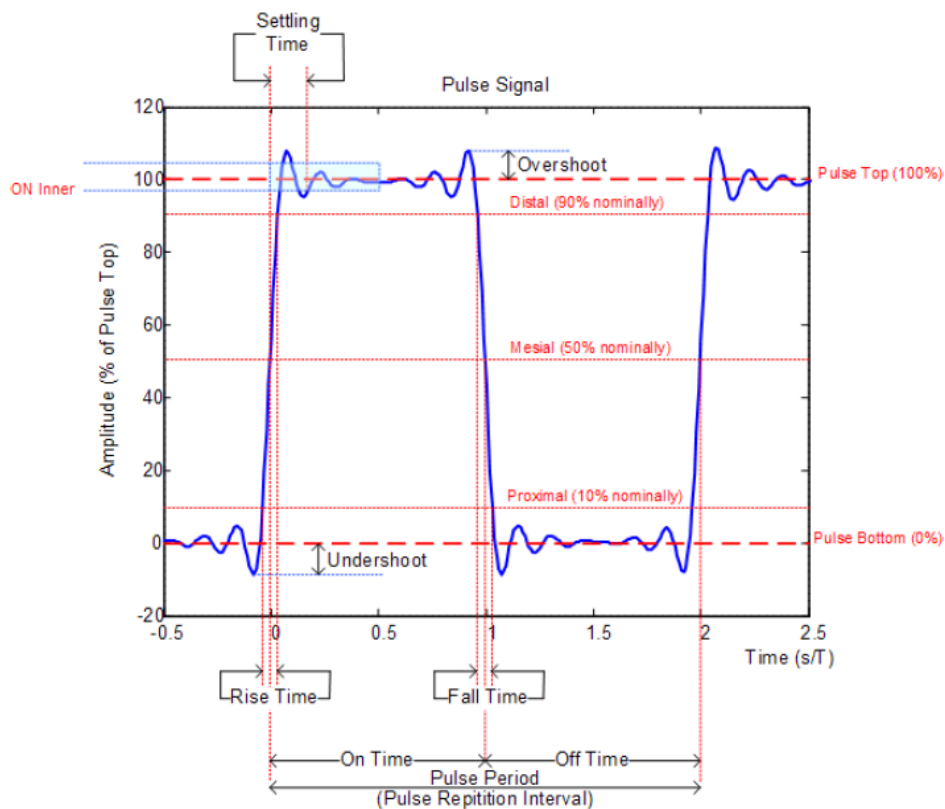

Figure 11-2: Graphical representation of pulse characteristic

Pulse characteristic	Description
"Pulse Width"	Time that the pulse remains at the top level ("ON"). This is the time between the first positive edge and the subsequent negative edge of the pulse in seconds, where the edges occur at crossings of the mid threshold.
"Pulse Period"	Time that is elapsing from the beginning of one pulse to the beginning of the next pulse.
"Pulse Off Time"	Time in the displayed trace that is not occupied by the pulse.
"Rise Time"	Time required for the pulse to transition from the base to the top level. This is the difference between the time at which the pulse exceeds the lower and upper thresholds.
"Fall Time"	Time required for the pulse to transition from the top to the base level. This is the difference between the time at which the pulse drops below the upper and lower thresholds.
"Duty Cycle"	Ratio of the "Pulse Width" to "Pulse Repetition Interval" expressed as a percentage (requires at least two measured pulses).

Pulse characteristic	Description
"Start Time"	Time offset, relative to the beginning of the trace (0 sec), where the pulse begins (start of the rise time).
"Stop Time"	Time offset, relative to the beginning of the trace (0 sec), where the pulse stops (end of the fall time).
"Pulse Top"	Median pulse ON power. The value of this parameter is used as a reference (100%) to determine other parameter values such as the rising / falling thresholds.
"Pulse Base"	Median pulse OFF power. The value of this parameter is used as a reference (0 %) to determine other parameter values such as the rising / falling thresholds.
"Trace Avg"	Average power of the signal displayed in the diagram.
"Trace Peak"	Maximum power of the signal displayed in the diagram.
"Trace Min"	Minimum power of the signal displayed in the diagram.
"Positive Overshoot"	Height of the local maximum after a rising edge, divided by the pulse amplitude. The result is a percentage of the pulse amplitude.
"Negative Overshoot"	Height of the local minimum after a rising edge, divided by the pulse amplitude. The result is a percentage of the pulse amplitude.

## 11.1 Configuring the numerical result display

The functions available for the numerical result display are the same as those available for normal power sensor measurements.

For more information, see [Chapter 10.1.2, "Performing and configuring measurements"](#), on page 195.

## 11.2 Configuring the power vs time result display

The R&S ZNH allows you to configure several aspects of the power vs time result display and the way the pulse is measured.

- [Determining pulse characteristics](#)..... 207
- [Selecting the video bandwidth](#)..... 208
- [Averaging traces](#)..... 208
- [Triggering measurements](#)..... 209

- [Selecting the result unit](#).....210
- [Scaling the y-axis](#).....210
- [Using markers](#).....210

## 11.2.1 Determining pulse characteristics

### Selecting an algorithm for base and top power calculation

The R&S ZNH provides several methods (or algorithms) to calculate the base and top power of a pulse.

- "Histogram"  
Calculates the top and base power of the pulse by analyzing the histogram of the trace data. The level of the pulse top calculated by the mean value of all points representing the pulse top. Similarly the level of the pulse base is calculated by the points representing the pulse base.  
This algorithm is recommended for analyzing most of the pulse signals
- "Integration"  
Calculates the top power of the pulse by fitting a rectangle pulse of the same energy into the pulse signal as a reference.  
This algorithm is recommended for modulated pulse signals or when the pulse energy must be taken into account, for example when you want to compare the measurement result with that of a thermal power sensor.
- "Peak"  
Assumes that the peak power of the pulse is also the top level of the pulse.

The top and base power is also the reference point for the calculation of pulse timing characteristics.

1. Press [MEAS] key.
2. Select "Algorithm" softkey.
3. Select the algorithm you prefer for your measurement.  
The R&S ZNH adjusts the results accordingly.

### Defining reference levels for pulse timing calculation

To calculate pulse timing parameters, like the rise and fall time of the pulse, you have to define several reference levels. All reference levels are a percentage of the pulse amplitude, either expressed in terms of power (Watt) or voltage (Volt).

The "Low Reference Power" and "High Reference Power" are required to calculate the fall and rise times of the measured pulse. The "Low Reference Power" defines the level at the start of the rising edge and the level at the end of the falling edge of the pulse. The "High Reference Power" defines the level at end of the rising edge and the level at the start of the falling edge.

The "Reference Power" is required to calculate the pulse width, its start time and its stop time.

1. Press [MEAS] key.
2. Select "Ref Power Config" softkey.
3. Define the reference levels as required.

You can always reset the reference levels to their default value with the "Set to Default" menu item.

All the reference levels can be relative to the power or the voltage of the signal. Depending on this selection, different measurement points are being analyzed, so the results may be different.

1. Press [MEAS] key.
2. Select "Ref Power Config" softkey.
3. Select either the "Related to Power" or the "Related to Voltage" menu item as the reference.

### 11.2.2 Selecting the video bandwidth

When you are using a wideband power sensor, you can change the video bandwidth used for the measurement. The main effect of using a small video bandwidth is that it reduces the displayed inherent noise.

Using a small video bandwidth thus increases the measurement sensitivity and allows you to accurately determine the pulse peak power even for weak pulses. Reducing the video bandwidth also increases the trigger sensitivity of the power sensor.

Note that the video bandwidth should not be smaller than the RF bandwidth of the measured signal. Otherwise, measurement results may become invalid.

### 11.2.3 Averaging traces

#### Selecting the trace mode

The "Power" vs "Time" result display provides two trace modes.

- The "Clear / Write" mode overwrites the trace data after each measurement.
- The "Average" mode forms an average over several measurements and displays the data according to the selected detector.

When you select this mode, you can define the number of measurements over which the trace data is calculated. When you select this mode, you can define the number of measurements over which the trace data is calculated.

1. Select "Trace" softkey
2. Select the trace mode you prefer for the measurement.



### Selecting the detector

When you are averaging traces, you can also select a detector. The detector defines the way the measured data is evaluated and which data is displayed.

In the "Power" vs "Time" result display, you can select the "Average" detector or the "Max Peak" detector. The "Average" detector displays the averaged measurement data, while the "Max Peak" detector displays the highest values that have been measured on each pixel.

1. Select "Detect" softkey.
2. Select the detector you prefer.

## 11.2.4 Triggering measurements

In its default state, the R&S ZNH starts a measurement on completion of the previous measurement ("Free Run" measurements).

However, you can also perform triggered measurements with the power sensor. When you choose to do so, the trigger event (the moment when the actual measurement starts) is either a rising slope in the signal or a falling slope ("Positive" or "Negative" trigger).

1. Press [SWEEP] key.
2. Select "Trigger" softkey.
3. Select either the "Positive" or "Negative" menu item.  
The R&S ZNH stops measuring the signal until a trigger event occurs.

In case of triggered measurements, you have to define a trigger level by which the signal must rise or fall in order to be recognized.

1. Press [SWEEP] softkey.
2. Select "Trigger" softkey.
3. Select either the "Trigger Level" menu item and define a trigger level.

In addition, you can define a trigger delay time. The trigger delay time defines a time that must pass after the trigger event has occurred before the measurement starts. A negative trigger delay time is called a pre-trigger.

1. Press [SWEEP] softkey.
2. Select "Trigger" softkey.
3. Select either the "Trigger Delay" menu item and define a delay time.  
When a trigger event occurs, the R&S ZNH takes the delay time into account when drawing the trace.

### 11.2.5 Selecting the result unit

In the pulse measurement application, the R&S R&S ZNH can display measured power in relative units (dBm) or in absolute units (W).

1. Press [SCALE/AMPT] key.
2. Select "Unit" softkey.
3. Select the unit you prefer.  
The R&S ZNH adjusts the y-axis accordingly.

### 11.2.6 Scaling the y-axis

For more information, see [Chapter 8.4.2, "Configuring the vertical axis"](#), on page 179.

### 11.2.7 Using markers

For more information, see [Chapter 8.5.2.1, "Using markers and deltamarkers"](#), on page 187.

## 12 Performing Frequency Conversion Power Measurements



### R&S ZNH option

R&S ZNH-K69 (order number: 1334.6830.02) option is required to operate the R&S ZNH in the power sensor vs frequency measurement mode.

When you equip the R&S ZNH with the R&S ZNH-K69 option and connect one of the supported power sensors available from Rohde & Schwarz, you can perform important parameters of mixer measurements such as frequency ranges, conversion gain, gain flatness and gain stability.

For a complete list of supported power sensors, refer to the data sheet.

RF mixer converts an RF signal at one frequency into a signal at another frequency. The frequency that is to be shifted is applied at the RF input. The frequency shifting signal (from a local oscillator, LO) is applied to the RF mixer's LO port, resulting in an output signal at the mixer's intermediate frequency (IF) port. See [Figure 12-1](#).

For a given RF signal, an ideal mixer would produce only two types of IF outputs:

- sum of the RF and LO ( $IF = RF + LO$ )
- difference between RF and LO ( $IF = RF - LO$ ,  $IF = LO - RF$ )

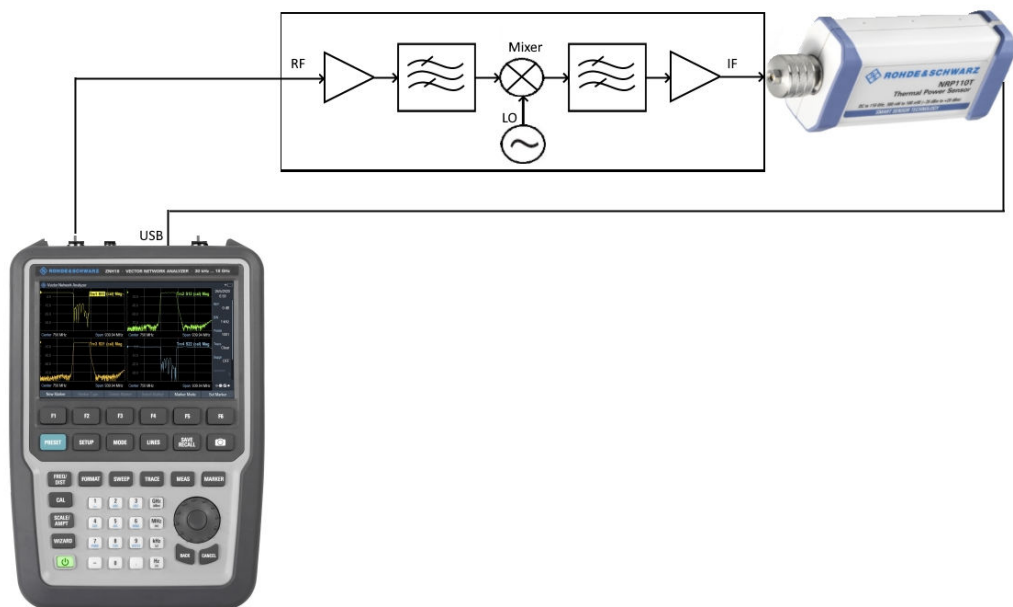

Figure 12-1: Typical setup for mixer measurement

1. Press [MODE] key.
2. Select "Power Meter" softkey

The R&S ZNH activates the mode for power measurements.

### Connecting the power sensor

You can connect a diode or thermal power sensors to the USB port of the R&S ZNH. For more information, see [Chapter 10.1.1, "Connecting a power sensor"](#), on page 194.

The measurement starts as soon as the power sensor is connected.

### Numerical result display

1. Press [MEAS] key.
2. Select "Meas Mode" softkey.
3. Select "Average" menu item.

The layout and contents of the numerical result display are the same as the layout and contents described in [Figure 10-1](#).

### Graphical result display (power vs frequency)

The graphical representation of the results is a special feature only available with the firmware option R&S ZNH-K69.

1. Press [MEAS] key.
2. Select "Meas Mode" softkey.
3. Select the "Power vs Freq" menu item.

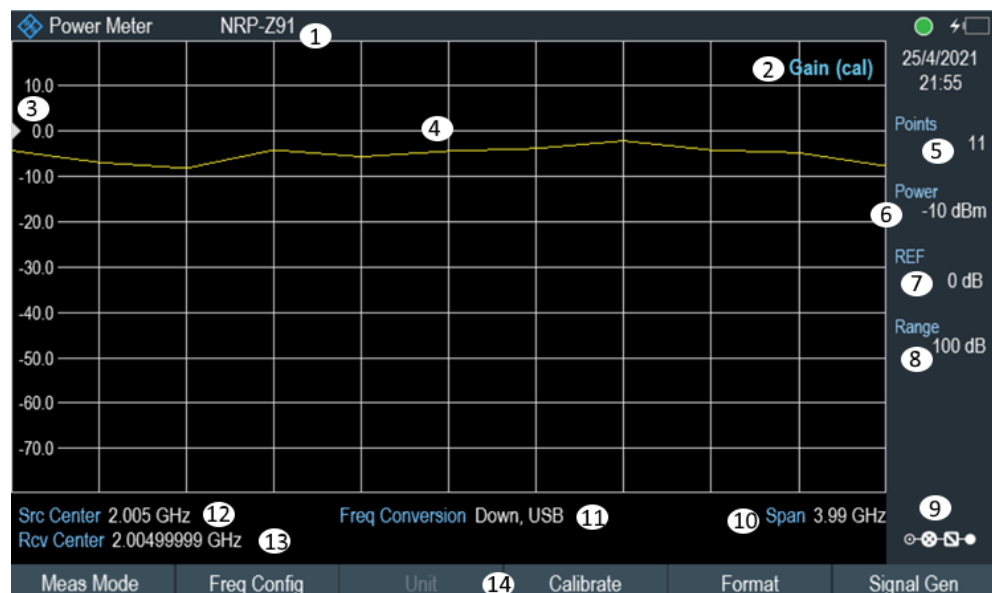

**Figure 12-2: Power vs frequency display**

- 1 = Connected power sensor model
- 2 = **Format** of measurement ("Absolute power", "Gain")
- 3, 7 = Reference position
- 4 = Diagram showing the power measurement in a graphical format (trace display)

- 5 = Number of measurement points
- 6 = Trace reference level
- 8 = Scale range of the x-axis
- 9 = Configuration overview icon
- 10 = Frequency span of the source and receiver frequency
- 11 = Type of frequency conversion ("Down, USB", "Down, LSB", "Up, USB")
- 12 = Center frequency of source signal
- 13 = Center frequency of receiver signal (y-axis)
- 14 = Softkey menu of the power vs frequency measurement application

## 12.1 Gain Calibration

Before performing any measurements, it is a good practice to perform a calibration to normalize the power sensor and also on the source signal for the gain measurement.

1. Press [CAL] key.
2. Select "Starts Gain calibration".  
The R&S ZNH starts the gain calibration procedure.
3. Alternatively, select [MEAS] > "Calibrate" to perform gain calibration procedure.
4. The R&S ZNH starts with zeroing the power sensor. For more information of the zeroing of power sensor, see ["Zeroing the power sensor"](#) on page 196.
5. After zeroing the power sensor, the R&S ZNH prompt you to connect sensor input to port 1 or port 2 (depending on selecting source port) to normalize source signal.



6. Select "Continue" to proceed gain calibration.



7. If gain calibration is successful, the R&S ZNH displays a message "Calibration Successful".

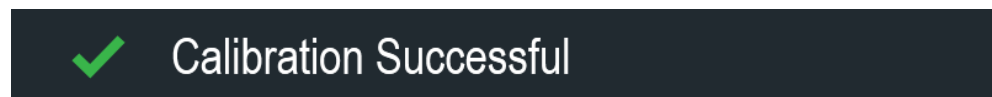

**Note:** Calibration cannot be performed if the target source frequency is beyond the frequency range of the power sensor. In this case, the calibration cannot proceed and the R&S ZNH displays "Power Sensor Error".



## Power Sensor Error

Calibration Failed. Power Sensor Out of Range.

## 12.2 Configuring the Numerical Result Display

The functions available for the numerical result display are the same as those functions available for normal power sensor measurements.

For more information, see [Chapter 10.1.2, "Performing and configuring measurements"](#), on page 195.

## 12.3 Configuring the Power with Frequency Result Display

The R&S ZNH allows you to configure several aspects of the power vs frequency result display and the way the power is measured.

- [Determining Frequency Conversion Measurement](#).....214
- [Defining Measurement Format](#).....216
- [Defining Source Signal](#).....217
- [Trace Memory](#).....217
- [Setting the Measurement Sweep](#).....218
- [Selecting the Result Unit](#).....218
- [Scaling the Y-Axis](#).....218
- [Using Markers](#).....218

### 12.3.1 Determining Frequency Conversion Measurement

#### Selecting an algorithm for frequency conversion measurement

The R&S ZNH provides several methods (or algorithms) to calculate the frequency conversion measurement. The example below shows the frequency conversion measurement methods with a source frequency of 5 GHz to 6 GHz and LO set at 4.5 GHz and 7 GHz respectively.



#### Frequency limitation

The source frequency is limited to the frequency range supported by the instrument and the receiving frequency is limited to the frequency range supported by the power sensor.

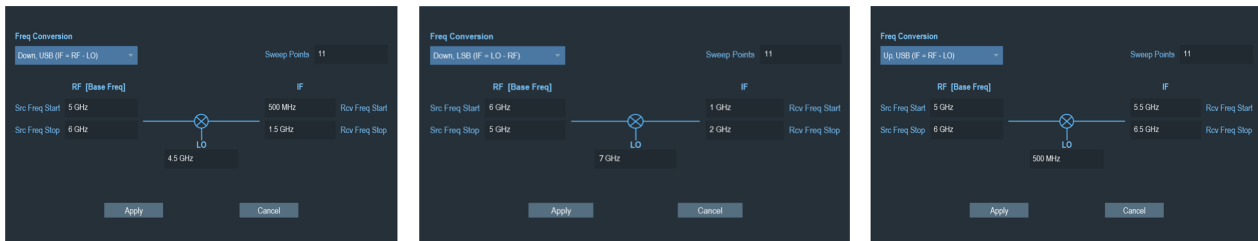

**Figure 12-3: Example of down-conversion and up-conversion algorithm**

- "Down, USB (IF = RF - LO)"  
Calculates the upper side band of the intermediate frequency (receiving frequency), IF using the down-conversion algorithm. A corresponding receiving frequency of 500 MHz to 1.5 GHz is displayed on the trace measurement.
  - "Down, LSB (IF = LO - RF)"  
Calculates the lower side band of the intermediate frequency (receiving frequency), IF using the down-conversion algorithm. A corresponding receiving frequency of 1 GHz to 2 GHz is displayed on the trace measurement. Note that the source frequency is swept in a reverse direction from higher frequency to lower frequency.
  - "Up, USB (IF = RF + LO)"  
Calculates the upper side band of intermediate frequency (receiving frequency), IF using the up-conversion algorithm. A corresponding receiving frequency of 5.5 GHz to 6 GHz is displayed on the trace measurement.
1. Press [FREQ] key.
  2. Select "Freq Conversion" softkey.  
The R&S ZNH displays the "Freq Conversion" dialog. See [Figure 12-3](#).
  3. Select the "Freq Conversion" to confirm the algorithm that you prefer for your measurement.  
The R&S ZNH adjusts the results accordingly.
  4. Enter the following parameters in the "Freq Conversion" dialog:
    - "Sweep Points": Number of measurement points
    - "RF [Base Freq]": Start and stop range for the source frequency.
    - "LO": Frequency for local oscillator
    - "IF": Calculated frequency range using the selected "Freq Conversion" algorithm.
  5. Select "Apply" to confirm the settings.

### Defining the frequency parameters

Apart from defining the frequency parameters in the "Freq Conversion" dialog, you can set the relevant frequency parameters in the following:

#### Source frequency

1. Press [FREQ] key.
2. Select "Src Freq" softkey to set source signal parameters.

- "Src Start", "Src Stop": Start and stop frequency for source signal.
  - "Src Center": Center frequency for source signal.
  - "Span": Common frequency span for source and receiving frequency.  
See also ["Common frequency span and number of measurement points"](#) on page 216.
  - "Back": Return to previous softkey menu
3. Select the required parameters for settings.  
See also ["Frequency limitation"](#) on page 214.

### Receiving frequency

1. Press [FREQ] key.
2. Select "Rcv Freq" softkey to set receiving signal parameters.
  - "Rcv Start", "Rcv Stop": Start and stop frequency for receiving signal.
  - "Rcv Center": Center frequency for receiving signal.
  - "Span": Common frequency span for source and receiving frequency.  
See also ["Common frequency span and number of measurement points"](#) on page 216.
  - "Back": Return to previous softkey menu
3. Select the required parameters for settings.  
See also ["Frequency limitation"](#) on page 214.

### Common frequency span and number of measurement points

1. Press [FREQ] key.
2. Select "Span" softkey to set the common frequency span for source and receiving signals.  
See also frequency span setting in ["Source frequency"](#) on page 215 and ["Receiving frequency"](#) on page 216.
3. Enter the required value.
4. Select "Points" softkey to set the number of measurement points for source and receiving signals.
5. Enter the required value.

## 12.3.2 Defining Measurement Format

There are two different measurement formats available for the power vs frequency measurement application.

- "Gain": Trace measurement of the measured power (dB) from power sensor normalized with the [calibration data](#).
- "Absolute Power": Trace measurement of the absolute power measured from the power sensor.



1. Press [MEAS] key.
2. Select "Format" softkey.  
The R&S ZNH displays the available measurement formats.
3. Alternatively, select [FORMAT] > "Format" to select the measurement formats.
4. Select the required measurement format.

### 12.3.3 Defining Source Signal

The R&S ZNH provides two different source ports for selection: "Port 1" and "Port 2".

1. Press [MEAS] key.
2. Select "Signal Gen" softkey.  
The R&S ZNH displays the signal generation softkey menu.
  - "SigGen On": Turns the generator on or off.
  - "Port Power": Sets source power.
  - "Port 1" / "Port 2": Sets driving/source port to port 1 / port 2
3. Select "Port 1" or "Port 2" to define source port setting.
4. Select "Port Power" to define source port signal level.
5. Enter the required port power level.

#### SigGen On



The frequency of the "SigGen On" function steps together with the [receiver frequency](#) in option R&S ZNH-K69. By default, the "SigGen On" function is turned on, by turning it off you can check if signal is leaking into or out of the mixer during measurement.

For more information on providing a "SigGen On" function, see ["Activating signal source"](#) on page 198.

### 12.3.4 Trace Memory

For more information, see [Chapter 7.3.1.3, "Working with memory traces"](#), on page 141.

#### Trace memory

For more information, see [Chapter 7.3.1.3, "Working with memory traces"](#), on page 141.

### 12.3.5 Setting the Measurement Sweep

For more information, see [Chapter 7.2.6, "Setting the measurement sweep"](#), on page 139.

### 12.3.6 Selecting the Result Unit

In the power vs frequency measurement application, the R&S R&S ZNH can display measured power in relative units (dBm) or in absolute units (W).

1. Press [SCALE/AMPT] key.
2. Select "Unit" softkey.
3. Alternatively, select [MEAS] > "Unit" to define the measurement unit.
4. Select the unit you prefer.  
The R&S ZNH adjusts the y-axis accordingly.

### 12.3.7 Scaling the Y-Axis

For more information, see [Chapter 8.4.2, "Configuring the vertical axis"](#), on page 179.

### 12.3.8 Using Markers

For more information, see [Chapter 8.5.2.1, "Using markers and deltamarkers"](#), on page 187.

# 13 Remote commands

The commands required to perform measurements in the Cable and Antenna Test application in a remote environment are described here.

- [Interfaces and protocols](#).....219
- [Setting up the remote control connection](#).....222
- [Instrument model and command processing](#)..... 223
- [SCPI command structure and syntax](#).....226
- [Command sequence and command synchronization](#)..... 235
- [Remote control - commands](#).....235

## 13.1 Interfaces and protocols

The R&S ZNH supports two different interfaces for remote control.

- [LAN interface](#): The protocol is based on TCP/IP and supports the VXI-11 standard
- [USB interface](#)

The connectors are located at the side of the instrument and permit a connection to a controller for remote control via a local area network (LAN) or directly via USB.

### SCPI

SCPI (Standard Commands for Programmable Instruments) commands - messages - are used for remote control. Commands that are not taken from the SCPI standard follow the SCPI syntax rules. The instrument supports the SCPI version 1999. The SCPI standard is based on standard IEEE 488.2 and aims at the standardization of device-specific commands, error handling and the status registers. The tutorial "Automatic Measurement Control - A tutorial on SCPI and IEEE 488.2" from John M. Pieper (order number 0002.3536.00) offers detailed information on concepts and definitions of SCPI.

The requirements that the SCPI standard places on command syntax, error handling and configuration of the status registers are explained in detail in the following sections. Tables provide a fast overview of the bit assignment in the status registers. The tables are supplemented by a comprehensive description of the status registers.

### VISA

VISA is a standardized software interface library providing input and output functions to communicate with instruments. The I/O channel (LAN or USB) is selected at initialization time by means of a channel-specific resource string. For more information about VISA refer to its user documentation.

The programming examples for remote control, are all written in Microsoft® VISUAL BASIC®. Access to the VISA functions require the declaration of the functions and constants before their use in the project. This can be accomplished either by adding the modules VISA32.BAS and VPPTYPE.BAS or a reference to the VISA32.DLL to the project.

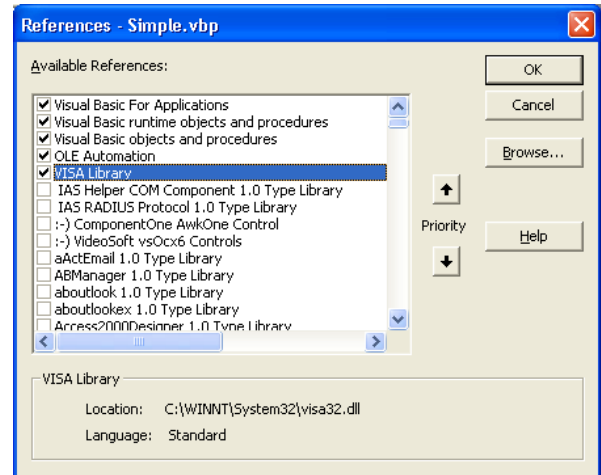
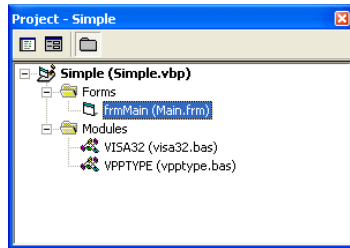

The modules VISA32.BAS and VPPTYPE.BAS can be found in the following location:  
 <VXIppnPath>WinNT\Include (typically C:\VXIppn\WinNt\Include).



### Resetting the R&S ZNH

Manual operation is designed for maximum possible operating convenience. In contrast, the priority of remote control is the "predictability" of the device status. Therefore, control programs should always define an initial device status (e.g. with the command \*RST) and then implement the required settings.

## 13.1.1 LAN interface

To be integrated in a LAN, the instrument is equipped with a standard LAN interface, consisting of a connector, a network interface and protocols (VXI-11).

Instrument access via VXI-11 is usually achieved from high level programming platforms by using VISA as an intermediate abstraction layer. VISA encapsulates the low level VXI-11 (LAN) or USB function calls and thus makes the transport interface transparent for the user. The necessary VISA library is available as a separate product. For details, contact your local R&S sales representative.

## 13.1.2 USB interface

For remote control via the USB connection, the PC and the instrument must be connected via the USB interface. The required driver comes with the R&S InstrumentView software package and is automatically installed on the PC with the software package.

The driver addressed the instrument via the USB interface with the fix IP address 172.16.10.10.

In addition, a remote control connection via the SCPI interface requires the VISA library to be installed on the PC.

### 13.1.3 Protocols

#### VXI-11 Basics

The VXI-11 standard is based on the ONC-RPC protocol which in turn relies on TCP/IP as the network/transport layer. The TCP/IP network protocol and the associated network services are preconfigured. TCP/IP ensures connection-oriented communication, where the order of the exchanged messages is adhered to and interrupted links are identified. With this protocol, messages cannot be lost.

Remote control of an instrument via a network is based on standardized protocols which follow the OSI reference model (see Fig. below).

Application	SCPI
Presentation	XDR (VXI-11)
Session	ONC-RPC
Transport	TCP / UDP
Network	IP
Data Link	Ethernet/802.3
Physical	802.3/10BASE-T

Figure 13-1: Example for LAN remote control based on the OSI reference model

Based on TCP/UDP, messages between the controller and the instrument are exchanged via open network computing (ONC) - remote procedure calls (RPC). With XDR (VXI-11), legal RPC messages are known as VXI-11 standard. Based on this standard, messages are exchanged between the controller and the instrument. The messages are identical with SCPI commands. They can be organized in four groups:

- Program messages (control command to the instrument).
- Response messages (values returned by the instrument).
- Service request (spontaneous queries of the instrument).
- Low-level control messages (interface messages).

A VXI-11 link between a controller and an instrument uses three channels: core, abort and interrupt channel. Instrument control is mainly performed on the core channel (program, response and low-level control messages). The abort channel is used for immediate abort of the core channel; the interrupt channel transmits spontaneous service requests of the instrument. Link setup itself is very complex. For more details, refer to the VXI-11 specification.

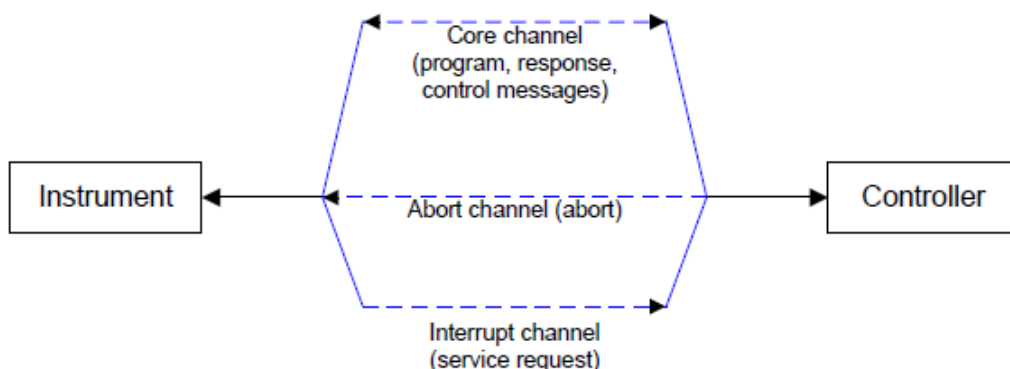

Figure 13-2: VXI-11 channels between instrument and controller

The number of controllers that can address an instrument is practically unlimited in the network. In the instrument, the individual controllers are clearly distinguished. This distinction continues up to the application level in the controller, i.e. two applications on a computer are identified by the instrument as two different controllers.

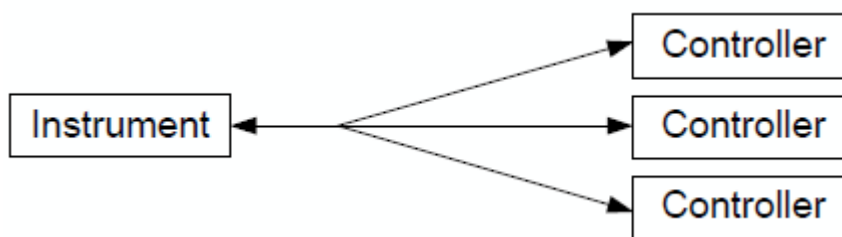

Figure 13-3: Remote control via LAN from several controllers

The controllers can lock and unlock the instrument for exclusive access. This regulates access to the instrument of several controllers.

## 13.2 Setting up the remote control connection

### 13.2.1 Preparing for remote control

The short and simple operating sequence below shows how to put the instrument into operation and quickly set its basic functions. The current IP address for LAN operation is shown in the SETUP – Instrument Setup Menu. In case of USB connection, the IP address is fixed to 172.16.10.10.

Refer [Chapter 4.3, "Connecting the R&S ZNH to a PC"](#), on page 52 for instructions on how to change the IP address.

- Connect the instrument to the LAN or directly to the controller via USB.
- Switch on the instruments.
- Write and start the following program on the controller:

```

- status = viOpenDefaultRM(defaultRM)
  'open default resource manager
- status = viOpen(DefaultRM, "TCPIP::172.16.10.10", 0, 0,
  vi)
  'in case of USB connection
- status = viopen(DefaultRM, "TCPIP::xxx.xxx.xxx.xxx", 0, 0,
  vi)
  'in case of a LAN connection, with xxx.xxx.xxx.xxx = IP address
- cmd = "*RST;*CLS"
- status = viWrite(vi, Cmd, Len(Cmd), retCount)
  'reset instrument and clear status registers
- cmd = "FREQ:CENT 100MHz"
- status = viWrite(vi, Cmd, Len(Cmd), retCount)
  'set center frequency to 100 MHz
- cmd = "FREQ:SPAN 10MHz"
- status = viWrite(vi, Cmd, Len(Cmd), retCount)
  'set span to 10 MHz
- cmd = "DISP:TRAC:Y:RLEV -10dBm"
- status = viWrite(vi, Cmd, Len(Cmd), retCount)
  'set reference level to -10 dBm
- viclose vi
- viclose default RM

```

The instrument now performs a sweep in the frequency range of 95 MHz to 105 MHz.

### Changing the IP address

In order to operate the instrument via remote control, it must be accessed via LAN (IP address) or USB (fixed IP address). If the factory-set remote control address does not fit in the network environment, it can be changed.

Refer [Chapter 4.3, "Connecting the R&S ZNH to a PC"](#), on page 52 for instructions on how to change the IP address.

## 13.3 Instrument model and command processing

The block diagram in [Figure 13-4](#) shows how SCPI commands are serviced in the instrument. The individual components work independently and simultaneously. They communicate with each other by means of so-called "messages".

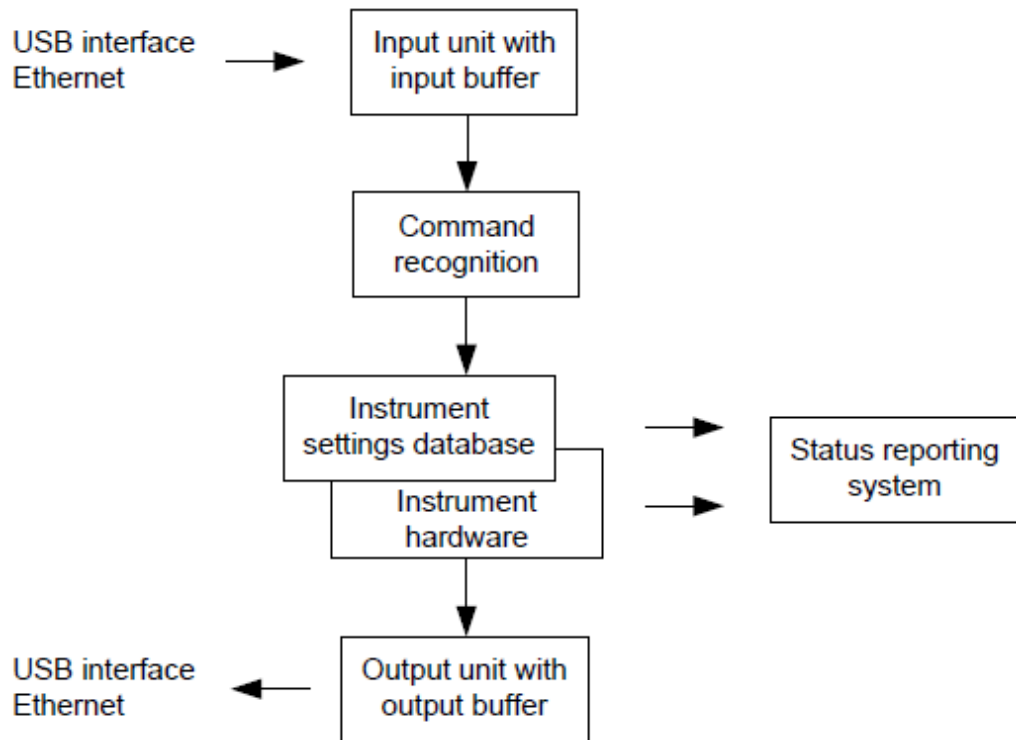

Figure 13-4: Instrument model in the case of remote control

• <a href="#">Input unit</a> .....	224
• <a href="#">Command recognition</a> .....	224
• <a href="#">Data base and instrument hardware</a> .....	225
• <a href="#">Status reporting system</a> .....	225
• <a href="#">Output unit</a> .....	225

### 13.3.1 Input unit

The input unit receives commands character by character from the controller and collects them in the input buffer. The input unit sends a message to the command recognition as soon as the input buffer is full or as soon as it receives a delimiter, <PROGRAM MESSAGE TERMINATOR>, as defined in IEEE 488.2, or the interface message DCL.

If the input buffer is full, the traffic is stopped and the data received up to then are processed. Subsequently the traffic is continued. If, however, the buffer is not yet full when receiving the delimiter, the input unit can already receive the next command during command recognition and execution. The receipt of DCL clears the input buffer and immediately resets the command recognition.

### 13.3.2 Command recognition

The command recognition analyses the data received from the input unit. It proceeds in the order in which it receives the data. Only DCL is serviced with priority, for exam-



ple GET (Group Execute Trigger) is only executed after the commands received before. Each recognized command is immediately transferred to the internal instrument settings data base but not executed immediately.

The command recognition detects syntax errors in the commands and transfers them to the status reporting system. The rest of a program message after a syntax error is analyzed further if possible and serviced. After the syntax test, the value range of the parameter is checked, if necessary.

If the command recognition detects a delimiter, it passes the command to an execution unit that performs the instrument settings. In the meantime, the command recognition is ready to process new commands (overlapping execution). A DCL command is processed in the same way.

### 13.3.3 Data base and instrument hardware

Here the expression "instrument hardware" denotes the part of the instrument fulfilling the actual instrument function - signal generation, measurement etc. The controller is not included. The term "data base" denotes a database that manages all the parameters and associated settings required for setting the instrument hardware.

Setting commands lead to an alteration in the data set. The data set management enters the new values (e.g. frequency) into the data set, however, only passes them on to the hardware when requested by the command recognition. This only takes place at the end of a program message.

The data are checked for compatibility with the current instrument settings before they are transmitted to the instrument hardware. If the execution is not possible, an "execution error" is signaled to the status reporting system. The corresponding settings are discarded.

Before passing on the data to the hardware, the settling bit in the STATUS:OPERation register is set (refer to section "[STATUS:OPERation register](#)" on page 363). The hardware executes the settings and resets the bit again as soon as the new state has settled. This fact can be used to synchronize command servicing.

Queries induce the data set management to send the desired data to the output unit.

### 13.3.4 Status reporting system

For detailed information, refer to [Status reporting system](#).

### 13.3.5 Output unit

The output unit collects the information requested by the controller, which it receives from the data base management. The output unit processes the information according to the SCPI rules and makes it available in the output buffer.

If the instrument is addressed as a talker without the output buffer containing data or awaiting data from the data base management, the output unit sends error message

"Query UNTERMINATED" to the status reporting system. No data are sent to the controller, the controller waits until it has reached its time limit. This behavior is defined by IEEE 488.2 and SCPI.

## 13.4 SCPI command structure and syntax

SCPI describes a standard command set for programming instruments, irrespective of the type of instrument or manufacturer. The goal of the SCPI consortium is to standardize the device-specific commands to a large extent. For this purpose, a model was developed which defines the same functions inside a device or for different devices. Command systems were generated which are assigned to these functions. Thus it is possible to address the same functions with identical commands. The command systems are of a hierarchical structure.

SCPI is based on standard IEEE 488.2, i.e. it uses the same syntactic basic elements as well as the common commands defined in this standard. Part of the syntax of the device responses is defined with greater restrictions than in standard IEEE 488.2 (see [Chapter 13.4.4, "Responses to queries"](#), on page 234).



### Remote command examples

Not all commands used in the following examples are implemented in the instrument.

- [Structure of a command](#).....226
- [Parameters](#).....231
- [Structure of a program message](#).....233
- [Responses to queries](#)..... 234

### 13.4.1 Structure of a command

The commands consist of a so-called header and, in most cases, one or more parameters. Header and parameter are separated by a "white space" (ASCII code 0 to 9, 11 to 32 decimal, e.g. blank). The headers may consist of several key words. Queries are formed by directly appending a question mark to the header.

- [Common commands](#).....226
- [Device-Specific commands](#).....227
- [Overview of syntax elements](#)..... 230

#### 13.4.1.1 Common commands

Common commands consist of a header preceded by an asterisk "\*" and one or several parameters, if any.

Table 13-1: Examples

Command	Operation	Description
*RST	RESET	Resets the device.
*ESE 253	EVENT STATUS ENABLE	Sets the bits of the EVENT STATUS ENABLE register.
*ESR?	EVENT STATUS QUERY	Queries the contents of the EVENT STATUS register.

### 13.4.1.2 Device-Specific commands

- [Hierarchy](#).....227
- [Multiple keywords](#).....228
- [Optional keywords](#).....228
- [Long and short form](#).....228
- [Parameter](#).....229
- [Special characters](#).....229
- [Numeric suffix](#).....230

#### Hierarchy

Device-specific commands are of hierarchical structure. The different levels are represented by combined headers. Headers of the highest level (root level) have only one key word. This key word denotes a complete command system.

#### Example:

SENSE

This key word denotes the SENSE command system.

For commands of lower levels, the complete path has to be specified, starting on the left with the highest level, the individual key words being separated by a colon ":".

#### Example:

SENSE:FREQUENCY:SPAN 10MHZ

This command lies in the third level of the SENSE system. It sets the frequency span.

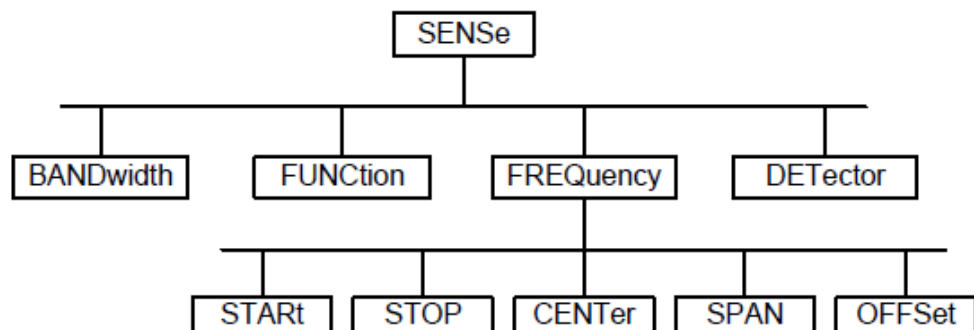

Figure 13-5: Tree structure the SCPI command systems using the SENSE system as example

### Multiple keywords

Some key words occur in several levels within one command system. Their effect depends on the structure of the command, i.e. at which position in the header of a command they are inserted.

#### Example:

```
SOURce:FM:POLarity NORMal
```

This command contains key word `POLarity` in the third command level. It defines the polarity between modulator and modulation signal.

#### Example:

```
SOURce:FM:EXTernal:POLarity NORMal
```

This command contains key word `POLarity` in the fourth command level. It defines the polarity between modulation voltage and the resulting direction of the modulation only for the external signal source indicated.

### Optional keywords

Some command systems permit certain key words to be inserted into the header or omitted. These key words are marked by square brackets in the description. The full command length must be recognized by the instrument for reasons of compatibility with the SCPI standard. Some commands are considerably shortened by these optional key words.

#### Example:

```
[SENSe]:BANDwidth[:RESolution]:AUTO
```

This command couples the resolution bandwidth of the instrument to other parameters. The following command has the same effect:

```
BANDwidth:AUTO
```



### Optional keywords with numeric suffixes

Do not omit an optional keyword if it includes a numeric suffix that is relevant for the effect of the command.

#### Example:

```
DISPlay[:WINDow<1..4>]:MAXimize <Boolean>
```

Command `DISP:MAX ON` refers to window 1.

In order to refer to a window other than 1, you must include the optional `WINDow` parameter with the suffix for the required window.

```
DISP:WIND2:MAX ON
```

refers to window 2.

### Long and short form

The key words feature a long form and a short form. Either the short form or the long form can be entered, other abbreviations are not permitted.

**Example:**

```
STATus:QUEStionable:ENABle 1
```

is equivalent to

```
STAT:QUES:ENAB 1
```

**Upper and lower case notation of commands**

Upper-case and lower-case notation only serves to distinguish the two forms in the manual, the instrument itself does not distinguish upper-case and lower-case letters.

**Parameter**

The parameter must be separated from the header by a "white space". If several parameters are specified in a command, they are separated by a comma ",". A few queries permit the parameters MINimum, MAXimum and DEFault to be entered. Refer to [Chapter 13.4.2, "Parameters"](#), on page 231 for a detailed description of the various parameters.

**Example:**

```
SENSe:FREQUency:STOP? MAXimum
```

Response: 3.5E9

This query requests the maximal value for the stop frequency.

**Special characters**

- **Vertical stroke |**

A vertical stroke in parameter definitions indicates alternative possibilities in the sense of "or". The effect of the command differs, depending on which parameter is used.

Example

```
– DISPLAY:FORMat SINGLE | SPLit
```

If parameter *SINGLE* is selected, full screen is displayed, in the case of *SPLIT*, split screen is displayed.

A selection of key words with an identical effect exists for several commands. These keywords are indicated in the same line; they are separated by a vertical stroke. Only one of these keywords needs to be included in the header of the command. The effect of the command is independent of which of the keywords is used.

```
– SENSE:BANDwidth|BWIDth[:RESolution]
```

The two following commands with identical meaning can be created. They set the frequency of the fixed frequency signal to 1 kHz:

```
SENSe:BAND 1
```

```
SENSe:BWID 1
```

- **Square brackets [ ]**

Key words in square brackets can be omitted when composing the header. The full command length must be accepted by the instrument for reasons of compatibility with the SCPI standards.

**Example**

- [SENSe:]BANDwidth|BWIDTH[:RESolution] or SENS:BAND:RES  
is equivalent to

BAND

Parameters in square brackets can be incorporated optionally in the command or omitted as well

- MMEMoRY:NETWoRK:MAP<string>,<string>[,<string>,<string>,<boolean>]

Entries in square brackets are optional or can be omitted.

- **Braces { }**

Parameters in curly brackets are optional and can be inserted once or several times, or omitted.

**Example**

- SENSE:LIST:FREQuency <numeric\_value>{,<numeric\_value>}

The following are valid commands:

SENS:LIST:FREQ 10

SENS:LIST:FREQ 10,20

SENS:LIST:FREQ 10,20,30,40

**Numeric suffix**

If a device features several functions or features of the same kind, e.g. inputs, the desired function can be selected by a suffix added to the command. Entries without suffix are interpreted like entries with the suffix 1. Optional keywords must be specified if they select a function with the suffix.

**Example:**

SYSTem:COMMunicate:SERial2:BAUD 9600

This command sets the baud rate of a second serial interface.

**Suffix counting**

In case of remote control, suffix counting may differ from the numbers of the corresponding selection used in manual operation. SCPI prescribes that suffix counting starts with 1. Suffix 1 is the default state and used when no specific suffix is specified.

Some standards define a fixed numbering, starting with 0. With GSM, for instance, slots are counted from 0 to 7. In the case of remote control, the slots are selected with the suffixes 1 to 8. If the numbering differs in manual operation and remote control, it is indicated with the respective command.

**13.4.1.3 Overview of syntax elements**

The following table offers an overview of the syntax elements.

Syntax element	Description
:	The colon separates the key words of a command. In a program message, the separating semicolon marks the uppermost command level.
;	The semicolon separates two commands within a program message. It does not alter the path.
,	The comma separates several parameters of a command.
?	The question mark forms a query.
*	The asterisk marks a common command.
" "	Quotation marks introduce a string and terminate it.
#	The hash symbol # introduces binary, octal, hexadecimal and block data. <ul style="list-style-type: none"> <li>• Binary: #B10110</li> <li>• Octal: #O7612</li> <li>• Hex: #HF3A7</li> </ul>
" "	A "white space" (ASCII-Code 0 to 9, 11 to 32 decimal, e.g. blank) separates header and parameter.

### 13.4.2 Parameters

For most commands, a parameter needs to be supplemented. The parameter has to be separated from the header by a "white space".

The type of parameter required for each command and the allowed range of values are specified in the command description.

- [Numeric values](#)..... 231
- [Special numeric values](#)..... 232
- [Boolean parameters](#)..... 232
- [Text](#)..... 232
- [Strings](#)..... 233
- [Block data](#)..... 233

#### 13.4.2.1 Numeric values

Numeric values can be entered in any form, i.e. with sign, decimal point and exponent. Values exceeding the resolution of the instrument are rounded up or down. The mantissa may comprise up to 255 characters, the exponent must lie inside the value range -32000 to 32000. The exponent is introduced by an "E" or "e". Entry of the exponent alone is not permissible. In the case of physical quantities, the unit can be entered. Permissible unit prefixes are G (giga), MA (mega), MOHM and MHZ are also possible), K (kilo), M (milli), U (micro) and N (nano). If the unit is missing, the basic unit is used.

**Example:**

```
SENSe:FREQuency:STOP 1.5GHz = SENSe:FREQuency:STOP 1.5E9
```

### 13.4.2.2 Special numeric values

The texts MINimum, MAXimum, DEFault, UP and DOWN are interpreted as special numeric values. In case of a query, the numeric value is returned.

- MIN/MAX  
MINimum and MAXimum denote the minimum and maximum value.
- DEF  
DEFault denotes a preset value which has been stored in the EPROM. This value conforms to the default setting, as it is called by the \*RST command
- UP/DOWN  
UP, DOWN increases or reduces the numerical value by one step. The step width can be specified via an allocated step command for each parameter which can be set via UP, DOWN.
- INF/NINF  
INFinity, Negative INFinity (NINF) Negative INFinity (NINF) represent the numerical values  $-9.9E37$  or  $9.9E37$ , respectively. INF and NINF are only sent as device response.
- NAN  
Not A Number (NAN) represents the value  $9.91E37$ . NAN is only sent as device response. This value is not defined. Possible causes are the division of zero by zero, the subtraction of infinite from infinite and the representation of missing values.

**Example:**

Setting command: `SENSe:FREQuency:STOP MAXimum`

Query: `SENSe:FREQuency:STOP?`

Response: `3.5E9`

### 13.4.2.3 Boolean parameters

Boolean parameters represent two states. The ON state (logically true) is represented by ON or a numerical value unequal to 0. The OFF state (logically untrue) is represented by OFF or the numerical value 0. The numerical values are provided as response for query.

**Example:**

Setting command: `CALCulate:MARKer:STATe ON`

Query: `CALCulate:MARKer:STATe?`

Response: `1`

### 13.4.2.4 Text

Text parameters observe the syntactic rules for key words, i.e. they can be entered using a short or long form. Like any parameter, they have to be separated from the header by a white space. In the case of a query, the short form of the text is provided.



**Example:**

Setting command: `INPut:COUPling GROund`

Query: `INPut:COUPling?`

Response: `GRO`

#### 13.4.2.5 Strings

Strings must always be entered in quotation marks (' or ").

**Example:**

`SYSTem:LANGUage "SCPI" or SYSTem:LANGUage 'SCPI'`

#### 13.4.2.6 Block data

Block data are a transmission format which is suitable for the transmission of large amounts of data. A command using a block data parameter has the following structure:

**Example:**

`HEADer:HEADer #45168xxxxxxxx`

ASCII character # introduces the data block. The next number indicates how many of the following digits describe the length of the data block. In the example, the four following digits indicate the length to be 5168 bytes. The data bytes follow. During the transmission of these data bytes all end or other control signs are ignored until all bytes are transmitted.

### 13.4.3 Structure of a program message

A program message may consist of one or several commands. It is terminated by the program message terminator which is the NL (New Line) character for LAN and USB connections.

Several commands in a program message must be separated by a semicolon ";". If the next command belongs to a different command system, the semicolon is followed by a colon. A colon ":" at the beginning of a command marks the root node of the command tree.

**Example:**

```
CALL InstrWrite(analyzer, "SENSe:FREQUency:CENTer 100MHz;:INPut:
ATTenuation 10")
```

This program message contains two commands. The first one is part of the `SENSe` command system and is used to determine the center frequency of the instrument. The second one is part of the `INPut` command system and sets the input signal attenuation.

If the successive commands belong to the same system, having one or several levels in common, the program message can be abbreviated. For that purpose, the second command after the semicolon starts with the level that lies below the common levels. The colon following the semicolon must be omitted in this case.

**Example:**

```
CALL InstrWrite(analyzer, "SENSe:FREQuency:START 1E6;:SENSe:
FREQuency:STOP 1E9")
```

This program message is represented in its full length and contains two commands separated from each other by the semicolon. Both commands are part of the SENSE command system, subsystem FREQUENCY, i.e. they have two common levels.

When abbreviating the program message, the second command begins with the level below SENSE:FREQUENCY. The colon after the semicolon is omitted. The abbreviated form of the program message reads as follows:

```
CALL InstrWrite(analyzer, "SENSe:FREQuency:START 1E6;STOP 1E9")
```

However, a new program message always begins with the complete path.

**Example:**

```
CALL InstrWrite(analyzer, "SENSe:FREQuency:START 1E6")
CALL InstrWrite(analyzer, "SENSe:FREQuency:STOP 1E9")
```

### 13.4.4 Responses to queries

A query is defined for each setting command unless explicitly specified otherwise. It is formed by adding a question mark to the associated setting command. According to SCPI, the responses to queries are partly subject to stricter rules than in standard IEEE 488.2.

- The requested parameter is transmitted without header.

**Example**

```
INPut:COUPling?
```

Response: DC

- Maximum values, minimum values and all further quantities, which are requested via a special text parameter are returned as numerical values.

**Example**

```
SENSe:FREQuency:STOP? MAX
```

Response: 3.5E9

- Numerical values are output without a unit. Physical quantities are referred to the basic units or to the units set using the Unit command.

**Example**

```
SENSe:FREQuency:CENTer?
```

Response: 1E6 (for 1 MHz)

- Truth values <Boolean values> are returned as 0 (for OFF) and 1 (for ON).

**Example**

```
SENSe:BANDwidth:AUTO?
```

Response: 1 (for ON)

- Text (character data) is returned in a short form.

**Example**

```
SYSTem:COMMunicate:SERial:CONTRol:RTS?
```

Response: STAN (for standard)

## 13.5 Command sequence and command synchronization

What has been said above makes clear that all commands can potentially be carried out overlapping. In order to prevent an overlapping execution of commands, one of the commands `*OPC`, `*OPC?` or `*WAI` must be used. All three commands cause a certain action only to be carried out after the hardware has been set. By suitable programming, the controller can be forced to wait for the respective action to occur.

For more information, see [Table 13-2](#)

**Table 13-2: Synchronization using `*OPC`, `*OPC?` and `*WAI`**

Command	Action	Programming the controller
<code>*OPC</code>	Sets the Operation Complete bit in the ESR after all previous commands have been executed.	<ul style="list-style-type: none"> <li>Setting bit 0 in the ESE</li> <li>Setting bit 5 in the SRE</li> <li>Waiting for service request (SRQ)</li> </ul>
<code>*OPC?</code>	Stops command processing until 1 is returned. This is only the case after the Operation Complete bit has been set in the ESR. This bit indicates that the previous setting has been completed.	Sending <code>*OPC?</code> directly after the command whose processing should be terminated before other commands can be executed.
<code>*WAI</code>	Stops further command processing until all commands sent before <code>*WAI</code> have been executed.	Sending <code>*WAI</code> directly after the command whose processing should be terminated before other commands are executed.

For a couple of commands, the synchronization to the end of command execution is mandatory in order to obtain the desired result. The affected commands require either more than one measurement in order to accomplish the desired instrument setting (e.g. auto range functions), or they require a longer period of time for execution. If a new command is received during execution of the corresponding function, this may either lead to either to an aborted measurement or to incorrect measurement data.

The following list includes the commands, for which a synchronization via `*OPC`, `*OPC?` or `*WAI` is mandatory:

**Table 13-3: Commands with mandatory synchronization (overlapping commands)**

Command	Purpose
<code>INIT</code>	Start measurement (sweep)
<code>INIT:CONT OFF</code>	Set to single sweep
<code>CALC:MARK:FUNC:xx?</code>	All Marker function queries

## 13.6 Remote control - commands

The following chapters provide a detailed description of all the remote control commands currently available for the R&S ZNH and its firmware options.

Each section describes the commands for one of the operating modes available in the R&S ZNH, beginning with the description of common commands required to operate the instrument.

- [Chapter 13.6.1, "Common commands"](#), on page 236
- [Chapter 13.6.3, "Remote commands of the cable and antenna analyzer"](#), on page 263
- [Chapter 13.6.2, "Remote commands of the vector network analyzer"](#), on page 240
- [Chapter 13.6.4, "Remote commands of the power meter"](#), on page 303

Each section is subdivided into various tasks required to perform measurements with the R&S ZNH, also based on the structure of the R&S ZNH user manual. Some commands like those for controlling markers or configuring the frequency axis are available for all operating modes. In that case, you can find a list of these commands in the corresponding section.



### Availability of commands

The vector network analyzer mode and cable and antenna test mode are implemented in the basic unit. For the other modes, the corresponding options are required.

Following the remote control commands required to perform specific measurements, you can find a description of general commands used to set up and control basic instrument functions. These commands are independent of the operating mode. Therefore they are listed separately.

- [Chapter 13.6.8, "File management"](#), on page 335
- [Chapter 13.6.9, "Making and storing screenshots"](#), on page 341
- [Chapter 13.6.10, "Configuring data capture"](#), on page 342
- [Chapter 13.6.11, "Configuring the instrument"](#), on page 344
- [Chapter 13.6.12, "Status reporting system"](#), on page 358

All chapters begin with a list of commands available in the context of that chapter. Following that list, you can find a detailed description of all the commands.

All individual descriptions contain:

- Complete notation and syntax of the command
- Description of the effects of the command
- A list of all parameters available for that command or the type of data the command returns in case of query commands
- An example of how a program message would look like
- The \*RST value

An alphabetical list of all available commands is provided at the end of this manual.

## 13.6.1 Common commands

The common commands are taken from the IEEE 488.2 (IEC 625-2) standard. A particular command has the same effect on different devices. The headers of these com-

mands consist of an asterisk "\*" followed by three letters. Some of the common commands refer to the [Chapter 13.6.12, "Status reporting system"](#), on page 358.

### List of common commands

*CLS.....	237
*ESE.....	237
*ESR?.....	237
*IDN?.....	238
*IST?.....	238
*OPC.....	238
*OPT?.....	238
*RST.....	238
*SRE.....	239
*STB?.....	239
*TRG.....	239
*TST?.....	239
*WAI.....	240

---

#### \*CLS

Clear status

Sets the status byte (STB), the standard event register (ESR) and the `EVENT` part of the `QUESTIONABLE` and the `OPERATION` registers to zero. The command does not alter the mask and transition parts of the registers. It clears the output buffer.

**Usage:**                   Setting only

---

#### \*ESE <Value>

Event status enable

Sets the event status enable register to the specified value. The query returns the contents of the event status enable register in decimal form.

**Parameters:**

<Value>                   Range:     0 to 255

---

#### \*ESR?

Event status read

Returns the contents of the event status register in decimal form and then sets the register to zero.

**Return values:**

<Contents>               Range:     0 to 255

**Usage:**                   Query only

---

**\*IDN?**

Identification

Returns the instrument identification.

**Return values:**

<ID> "Rohde&Schwarz,<device type>,<part number>/<serial number>,<firmware version>"

**Usage:** Query only

---

**\*IST?**

Individual status query

Returns the contents of the IST flag in decimal form. The IST flag is the status bit which is sent during a parallel poll.

**Return values:**

<ISTflag> 0 | 1

**Usage:** Query only

---

**\*OPC**

Operation complete

Sets bit 0 in the event status register when all preceding commands have been executed. This bit can be used to initiate a service request. The query writes a "1" into the output buffer when all preceding commands have been executed, which is useful for command synchronization.

---

**\*OPT?**

Option identification query

Queries the options included in the instrument. For a list of all available options and their description, refer to the data sheet.

**Return values:**

<Options> The query returns a list of all installed and activated options, separated by commas, where:  
B<number> describes hardware options.  
K<number> describes software options.

**Usage:** Query only

---

**\*RST**

Reset

Sets the instrument to a defined default status. The default settings are indicated in the description of commands.

The command is equivalent to `SYSTem:PRESet`.

**Usage:**                   Setting only

---

**\*SRE** <Contents>

Service request enable

Sets the service request enable register to the indicated value. This command determines under which conditions a service request is triggered.

**Parameters:**

<Contents>                   Contents of the service request enable register in decimal form.  
Bit 6 (MSS mask bit) is always 0.  
Range:            0 to 255

---

**\*STB?**

Status byte query

Reads the contents of the status byte in decimal form.

**Usage:**                   Query only

---

**\*TRG**

Trigger

Triggers all actions waiting for a trigger event. In particular, \*TRG generates a manual trigger signal. This common command complements the commands of the `TRIGger` subsystem.

\*TRG corresponds to the `INITiate:IMMediate` command.

**Usage:**                   Event

---

**\*TST?**

Self-test query

Initiates self-tests of the instrument and returns an error code.

**Return values:**

<ErrorCode>                   **integer > 0 (in decimal format)**  
An error occurred.  
**0**  
No errors occurred.

**Usage:**                   Query only

**\*WAI**

Wait to continue

Prevents servicing of the subsequent commands until all preceding commands have been executed and all signals have settled (see also command synchronization and [\\*OPC](#)).

**Usage:** Event

## 13.6.2 Remote commands of the vector network analyzer

This section provides a detailed description of all remote control commands required to configure and perform measurements in Vector Network Analyzer (VNA) mode.

- [Configuring the horizontal axis](#).....240
- [Configuring the vertical axis](#)..... 240
- [Setting the bandwidth](#).....247
- [Performing and triggering the measurements](#).....247
- [Working with traces](#).....250
- [Using markers and deltamarkers](#).....252
- [Configuring and using measurement functions](#).....253

### 13.6.2.1 Configuring the horizontal axis

The following commands configure the horizontal (frequency) axis of the active display.

#### List of commands

- [\[SENSe:\] FREQuency:CENTer](#) on page 264
- [\[SENSe:\] FREQuency:CENTer:STEP](#) on page 264
- [\[SENSe:\] FREQuency:CENTer:STEP:LINK](#) on page 264
- [\[SENSe:\] FREQuency:SPAN](#) on page 264
- [\[SENSe:\] FREQuency:SPAN:FULL](#) on page 265
- [\[SENSe:\] FREQuency:START](#) on page 265
- [\[SENSe:\] FREQuency:STOP](#) on page 265

For a detailed description of the commands, see [Configuring the horizontal axis](#) in CAT mode.

### 13.6.2.2 Configuring the vertical axis

The following commands configure the vertical (level) axis of the active display.

The suffix <t> selects the measurement trace. It is in the range of <1..4>.

The suffix <p> selects the measurement port. It is in the range of <1..2>.



### List of commands

- [DISPlay<t>:LOSS:REFeRence](#) on page 269
- [DISPlay<t>:LOSS:REFeRence:POSition](#) on page 269
- [DISPlay<t>:LOSS:Y:SCALe](#) on page 269
- [DISPlay<t>:MAGNitude:REFeRence](#) on page 270
- [DISPlay<t>:MAGNitude:REFeRence:POSition](#) on page 270
- [DISPlay<t>:MAGNitude:Y:SCALe](#) on page 270
- [DISPlay<t>:MAGNitude:Y:SPACing](#) on page 271
- [DISPlay<t>:PHASe:REFeRence](#) on page 271
- [DISPlay<t>:PHASe:REFeRence:POSition](#) on page 271
- [DISPlay<t>:PHASe:Y:SCALe](#) on page 272
- [DISPlay<t>:PHASe:UNWRap](#) on page 272
- [DISPlay<t>:VSWR:Y:SCALe:MINimum](#) on page 273
- [DISPlay<t>:VSWR:Y:SCALe:MAXimum](#) on page 273
- [DISPlay<t>:VSWR:Y:SCALe](#) on page 272

For a detailed description of the commands not described below, see [Configuring the vertical axis](#) in CAT mode.

<a href="#">DISPlay&lt;t&gt;:GDElay:REFeRence</a> .....	241
<a href="#">DISPlay&lt;t&gt;:GDElay:REFeRence:POSition</a> .....	242
<a href="#">DISPlay&lt;t&gt;:GDElay:Y:SCALe</a> .....	242
<a href="#">DISPlay&lt;t&gt;:IMAGinary:REFeRence</a> .....	242
<a href="#">DISPlay&lt;t&gt;:IMAGinary:REFeRence:POSition</a> .....	243
<a href="#">DISPlay&lt;t&gt;:IMAGinary:Y:SCALe</a> .....	243
<a href="#">DISPlay&lt;t&gt;:MLINear:REFeRence</a> .....	243
<a href="#">DISPlay&lt;t&gt;:MLINear:REFeRence:POSition</a> .....	244
<a href="#">DISPlay&lt;t&gt;:MLINear:Y:SCALe</a> .....	244
<a href="#">DISPlay&lt;t&gt;:REAL:REFeRence</a> .....	244
<a href="#">DISPlay&lt;t&gt;:REAL:REFeRence:POSition</a> .....	245
<a href="#">DISPlay&lt;t&gt;:REAL:Y:SCALe</a> .....	245
<a href="#">DISPlay&lt;t&gt;:REFLection:UNIT</a> .....	245
<a href="#">DISPlay&lt;t&gt;:REFLection:Y:SCALe</a> .....	246
<a href="#">INPut:ATTenuation&lt;p&gt;</a> .....	246
<a href="#">UNIT&lt;t&gt;:POWER</a> .....	246

---

#### **DISPlay<t>:GDElay:REFeRence <RefLevel>**

This command sets the reference value for the group delay measurement format.

##### **Suffix:**

<t>                      1..n

##### **Parameters:**

<RefLevel>              Default unit: S

##### **Example:**

DISP:GDEL:REF 20

Sets the reference level to 20 nanoseconds.

**DISPlay<t>:GDElay:REFErence:POSition <RefPosition>**

This command defines the position of the reference value on the display for the group delay measurement format.

Each step shifts the reference position one grid line up or down.

**Suffix:**

<t> 1..n

**Parameters:**

<RefPosition> Numeric value in the range from 0 to 10.  
\*RST: 5

**Example:**

DISP:GDEL:REF:POS 1  
Sets the reference to the first grid line from the bottom.

**DISPlay<t>:GDElay:Y:SCALE <DisplayRange>**

This command defines the display range of the vertical axis for the group delay measurement format.

**Suffix:**

<t> 1..n

**Parameters:**

<DisplayRange> Numeric value in the range from 10 ns to 100000 ns.  
The number you enter is rounded up to the next possible display range. For example, if you enter 9, the R&S ZNH automatically sets the display range to 10.  
\*RST: 100 ns  
Default unit: S

**Example:**

DISP:GDEL:Y:SCAL 20E-9  
Sets the display range to 20 nanoseconds

**DISPlay<t>:IMAGinary:REFErence <RefLevel>**

This command defines the reference value for the imaginary part of the measurement format.

**Suffix:**

<t> 1..n

**Parameters:**

<RefLevel> Numeric value of the reference level.  
\*RST: 0 dB  
Default unit: dB

**Example:**

DISP:IMAG:REF -10  
Defines a reference level of -10 dB.

**DISPlay<t>:IMAGinary:REFerence:POSition <RefPosition>**

This command defines the position of the reference value in the diagram for the imaginary part of the magnitude measurement format.

Each step shifts the reference position one grid line up or down.

**Suffix:**

<t> 1..n

**Parameters:**

<RefPosition> Numeric value of the reference position.

\*RST: 10

**Example:**

DISP:IMAG:REF:POS 5

Moves the reference to the fifth grid line from the bottom.

**DISPlay<t>:IMAGinary:Y:SCALE <DisplayRange>**

This command defines the display range of the vertical axis for the imaginary part of the magnitude measurement format.

Note that you have to set a logarithmic scaling before you can use this command with [DISPlay<t>:MAGNitude:Y:SPACing](#) on page 271.

**Suffix:**

<t> 1..n

**Parameters:**

<DisplayRange> Numeric value of the display range.

The number you enter is rounded up to the next possible display range. For example, if you enter 9, the R&S ZNH automatically sets the display range to 10.

\*RST: 100 dB

Default unit: dB

**Example:**

DISP:IMAG:Y:SCALE 50 DB

Defines a display range of 50 dB.

**DISPlay<t>:MLINear:REFerence <RefLevel>**

This command defines the reference value for the linear scale of the magnitude measurement format.

**Suffix:**

<t> 1..n

**Parameters:**

<RefLevel> Numeric value of the reference level.

\*RST: 0 dB

Default unit: dB

**Example:**

DISP:MLIN:REF -10

Defines a reference level of -10 dB.

**DISPlay<t>:MLINear:REFerence:POSition** <RefPosition>

This command defines the position of the reference value in the diagram for the linear part of the magnitude measurement format.

Each step shifts the reference position one grid line up or down.

**Suffix:**

<t> 1..n

**Parameters:**

<RefPosition> Numeric value of the reference position.

\*RST: 10

**Example:**

DISP:MLIN:REF:POS 5

Moves the reference to the fifth grid line from the bottom.

**DISPlay<t>:MLINear:Y:SCALE** <DisplayRange>

This command defines the display range of the vertical axis for the linear part of the magnitude measurement format.

Note that you have to set a logarithmic scaling before you can use this command with [DISPlay<t>:MAGNitude:Y:SPACing](#) on page 271.

**Suffix:**

<t> 1..n

**Parameters:**

<DisplayRange> Numeric value of the display range.

The number you enter is rounded up to the next possible display range. For example, if you enter 9, the R&S ZNH automatically sets the display range to 10.

\*RST: 100 dB

Default unit: dB

**Example:**

DISP:MLIN:Y:SCAL 50 DB

Defines a display range of 50 dB.

**DISPlay<t>:REAL:REFerence** <RefLevel>

This command defines the reference value for the real part of the magnitude measurement format.

**Suffix:**

<t> 1..n

**Parameters:**

<RefLevel> Numeric value of the reference level.

\*RST: 0 dB

Default unit: dB

**Example:**

DISP:REAL:REF -10

Defines a reference level of -10 dB.

**DISPlay<t>:REAL:REFerence:POSition** <RefPosition>

This command defines the position of the reference value in the diagram for the real part of the magnitude measurement format.

Each step shifts the reference position one grid line up or down.

**Suffix:**

<t> 1..n

**Parameters:**

<RefPosition> Numeric value of the reference position.

\*RST: 10

**Example:**

DISP:REAL:REF:POS 5

Moves the reference to the fifth grid line from the bottom.

**DISPlay<t>:REAL:Y:SCALE** <DisplayRange>

This command defines the display range of the vertical axis for the real part of the magnitude measurement format.

Note that you have to set a logarithmic scaling before you can use this command with [DISPlay<t>:MAGNitude:Y:SPACing](#) on page 271.

**Suffix:**

<t> 1..n

**Parameters:**

<DisplayRange> Numeric value of the display range.

The number you enter is rounded up to the next possible display range. For example, if you enter 9, the R&S ZNH automatically sets the display range to 10.

\*RST: 100 dB

Default unit: dB

**Example:**

DISP:REAL:Y:SCAL 50 DB

Defines a display range of 50 dB.

**DISPlay<t>:REFLection:UNIT** <Unit>

This command defines the unit of the reflection coefficient.

**Suffix:**

<t> 1..n

**Parameters:**

<Unit> RHO | MRHO

**Example:**

DISP:REFL:UNIT RHO

Set unit of the reflection coefficient.

---

**DISPlay<t>:REFlection:Y:SCALe <DisplayRange>**

This command defines the display range of the vertical axis for the reflection coefficient measurement format.

**Suffix:**

<t> 1..n

**Parameters:**

<DisplayRange> Numeric value in the range from 1 dB to 1000 mrho.  
The number you enter is rounded up to the next possible display range. For example, if you enter 18, the R&S ZNH automatically sets the display range to 20 mrho.  
Default unit: RHO

**Example:**

DISP:REFL:Y:SCAL 100  
Sets a display range of 100 mrho.

---

**INPut:ATTenuation<p> <Attenuation>**

This command defines the input attenuation.

The attenuation is coupled to the reference level. If you set the attenuation independently, the R&S ZNH turns off this coupling.

The R&S ZNH adjusts the reference level if it cannot be set for the current RF attenuation.

**Suffix:**

<p> 1..n  
RF port selection. Default selection at 1.

**Parameters:**

<Attenuation> Range: 0 dB to 40 dB  
\*RST: 0 dB (AUTO is ON)  
Default unit: dB

**Example:**

INP:ATT1 30dB  
Defines RF attenuation of 30 dB at RF port 1 and deactivates coupling to the reference level.

---

**UNIT<t>:POWer <Unit>**

This command selects the unit of the vertical axis.

The availability of units depends on the operating mode and type of measurement.

**Suffix:**

<t> 1..n

**Parameters:**

<Unit> DBM | DBMV | DBUV | DUVE | DMVE | VEMF | DBUA | VOLT |  
WATT | DUVM | DUAM | V | W | V\_M | W\_M2 | DB | RHO |  
MRHO

Note that the availability of units depends on the operating mode.

\*RST: DBM

**Example:**

UNIT:POW DBM

Sets the power unit to dBm.

**13.6.2.3 Setting the bandwidth**

The following commands configure the filter bandwidths of the R&S ZNH. Note that both groups of commands (`BANDwidth` and `BWIDth`) are the same.

**List of commands**

- `[SENSe:]BANDwidth|BWIDth[:RESolution] <MeasBW>`
- `[SENSe:]BANDwidth|BWIDth[:RESolution]:AUTO <State>`

For a detailed description of the commands, see [Setting the bandwidth](#) in CAT mode.

**13.6.2.4 Performing and triggering the measurements**

The following commands control the actual measurement process.

**List of commands**

- `*WAI` on page 240
- `INITiate:CONTInuous` on page 274
- `[SENSe:]SWEep:POINTs` on page 274

For a detailed description of the commands not described below, see [Common commands](#) and [Performing measurements](#) in CAT mode.

<code>ABORt</code> .....	247
<code>INITiate[:IMMediate]</code> .....	248
<code>[SENSe:]SWEep:COUNT</code> .....	248
<code>[SENSe:]SWEep:TIME</code> .....	248
<code>[SENSe:]SWEep:TIME:AUTO</code> .....	249
<code>TRIGger[:SEQuence]:HOLDoff[:TIME]</code> .....	249
<code>TRIGger[:SEQuence]:SLOPe</code> .....	249
<code>TRIGger[:SEQuence]:SOURce</code> .....	250

**ABORt**

This command aborts the current measurement and resets the trigger system.

This command is an event and therefore has no query and no \*RST value.

**Example:**            ABOR;  
                          INIT:IMM  
                          Aborts a measurement and starts a new one.

**Usage:**             Event

**INITiate[:IMMEDIATE]**

This command initiates a new measurement sequence.

With sweep count > 0 or average count > 0, this means a restart of the indicated number of measurements. With trace functions MAXHold, MINHold and AVERage, the previous results are reset on restarting the measurement.

In single sweep mode, synchronization to the end of the indicated number of measurements can be achieved with the command \*OPC, \*OPC? or \*WAI. In continuous-sweep mode, synchronization to the sweep end is not possible since the overall measurement never ends.

This command is an event and therefore has no query and no \*RST value.

**Example:**            INIT:CONT OFF  
                          DISP:WIND:TRAC:MODE AVER  
                          Turns on single sweep mode and trace averaging.  
                          INIT;\*WAI  
                          Starts the measurement and waits for the end of the sweep.

**Usage:**             Event

**[SENSe:]SWEep:COUNT <#ofSweeps>**

This command defines the number of sweeps included in a single sweep. It also defines the number of sweeps the R&S ZNH uses to average traces or calculate maximum values.

The R&S ZNH performs one sweep for sweep count 0 or 1.

**Parameters:**

<#ofSweeps>           Range:     1 to 999  
                          \*RST:     10

**Example:**            SWE:COUN 64  
                          Defines a sweep count of 64 sweeps.  
                          INIT:CONT OFF  
                          INIT;\*WAI  
                          Turns on single sweep mode, starts the sweep and waits for its end.

**[SENSe:]SWEep:TIME <SweepTime>**

This command defines the sweep time.



If you set a sweep time with this command, the R&S ZNH decouples the sweep time from the span and the resolution and video bandwidths.

**Parameters:**

<SweepTime>      Range:      Specified in the datasheet.  
 \*RST:              - (AUTO is set to ON)  
 Default unit: s

**Example:**

SWE:TIME 10s  
 Sets the sweep time to 10 s.

**[SENSe:]SWEep:TIME:AUTO <State>**

This command couples and decouples the sweep time to the span and the resolution and video bandwidths.

**Parameters:**

<State>              ON | OFF  
 \*RST:              ON

**Example:**

SWE:TIME:AUTO ON  
 Switches on the coupling to frequency span and bandwidths.

**TRIGger[:SEQuence]:HOLDoff[:TIME] <TriggerDelay>**

This command defines the length of the trigger delay.

**Parameters:**

<TriggerDelay>      Range:      0 s to 100 s  
 \*RST:              0 s  
 Default unit: s

**Example:**

TRIG:HOLD 500us  
 Sets the trigger delay to 500 µs.

**TRIGger[:SEQuence]:SLOPe <TriggerSlope>**

This command selects the slope of the trigger signal.

The trigger slope applies to all trigger sources.

**Parameters:**

<TriggerSlope>      POSitive | NEGative  
 \*RST:              POSitive

**Example:**

TRIG:SLOP NEG

**TRIGger[:SEQuence]:SOURce** <TriggerSource>

This command selects the trigger source.

**Parameters:**

<TriggerSource> IMMEDIATE | EXTERNAL | VIDEO | IQPOWER | GATED

**IMMEDIATE**

Selects Free Run measurements.

**EXTERNAL**

Selects an external trigger.

**VIDEO**

Selects the video trigger.

**IQPOWER**

Selects an IQ Power trigger.

**Gated**

Selects a gated trigger.

\*RST: IMMEDIATE

**Example:**

TRIG:SOUR EXT

Selects the external trigger input as source of the trigger signal.

**13.6.2.5 Working with traces**

The following commands set up the trace and the various functions associated with it, e.g. trace mathematics or the selection of the detector.

The suffix <t> selects the measurement trace. It is in the range of <1..4>.

**List of commands**

- [DISPlay\[:WINDow\]:TRACe<t>:MEMory\[:STATe\]](#) on page 275
- [DISPlay\[:WINDow\]:TRACe<t>:MODE](#) on page 276
- [FORMat\[:DATA\]](#) on page 276
- [FORMat:BORDER](#) on page 277
- [MEASurement<t>:ISUP](#) on page 277
- [MEASurement<t>:ISUP:APER](#) on page 277
- [MEASurement<t>:ISUP:APER:AUTO](#) on page 277
- [TRACe<t>\[:DATA\]?](#) on page 278
- [TRACe<t>\[:DATA\]:MEMory?](#) on page 279

For a detailed description of the commands not described below, see [Working with traces](#) in the CAT mode.

<a href="#">DISPlay&lt;t&gt;:LAYout</a> .....	251
<a href="#">[SENSe:]DETEctor&lt;t&gt;[:FUNCTion]</a> .....	251
<a href="#">[SENSe:]DETEctor&lt;t&gt;[:FUNCTion]:AUTO</a> .....	251

**DISPlay<t>:LAYout** <LayoutMode>

This command arranges the diagrams in the screen, leaving the diagram contents unchanged.

**Suffix:**

<t> 1..n

**Parameters:**

<LayoutMode> SINGle | DHORizontal | DVERTical | TRIPlE | QUADruple

**SINGle**

One measurement trace window is displayed.

**DHORizontal**

Two measurement trace windows are arranged in top and bottom rows.

**DVERTical**

Two measurement trace windows are arranged side by side.

**Triple**

Three measurement trace windows are displayed with one at the top and two at the bottom arranged side by side.

**QUADruple**

Four measurement trace windows are displayed with two at the top and two at the bottom rows.

**Example:**

```
DISP:LAY SING
```

Single measurement trace window is displayed.

**[SENSe:]DETEctor<t>[:FUNCTion]** <Detector>

This command selects a detector function.

**Suffix:**

<t> 1..n

**Parameters:**

<Detector> POSitive | NEGative | SAMPlE | RMS | AVERage | APEak

\*RST: APE

**Example:**

```
DET POS
```

Sets the primary detector to "positive peak".

**[SENSe:]DETEctor<t>[:FUNCTion]:AUTO** <State>

This command couples and decouples the detector to the trace mode.

**Suffix:**

<t> 1..n

**Parameters:**

<State> ON | OFF

\*RST: ON

**Example:**                    `DET:AUTO OFF`  
                                  Turns off automatic detector selection for primary detector.

### 13.6.2.6 Using markers and deltamarkers

The following commands control the operation of marker and delta markers.

The suffix `<m>` selects the marker. It is in the range of `<1..6>`.

The suffix `<l>` selects the limit line. It is in the range of `<1..2>`.

The suffix `<t>` selects the measurement trace. It is in the range of `<1..4>`.

#### List of commands

- [CALCulate<t>:DELTaMarker<m>\[:STATe\]](#) on page 280
- [CALCulate<t>:DELTaMarker<m>:AOFF](#) on page 280
- [CALCulate<t>:DELTaMarker<m>:MAXimum\[:PEAK\]](#) on page 281
- [CALCulate<t>:DELTaMarker<m>:MAXimum:NEXT](#) on page 281
- [CALCulate<t>:DELTaMarker<m>:MINimum\[:PEAK\]](#) on page 281
- [CALCulate<t>:DELTaMarker<m>:X](#) on page 282
- [CALCulate<t>:DELTaMarker<m>:X:RELative](#) on page 282
- [CALCulate<t>:DELTaMarker<m>:Y?](#) on page 282
- [CALCulate<t>:MARKer<m>\[:STATe\]](#) on page 283
- [CALCulate<t>:MARKer<m>:AOFF](#) on page 283
- [CALCulate<t>:MARKer<m>:MAXimum\[:PEAK\]](#) on page 284
- [CALCulate<t>:MARKer<m>:MAXimum:NEXT](#) on page 284
- [CALCulate<t>:MARKer<m>:MINimum\[:PEAK\]](#) on page 285
- [CALCulate<t>:MARKer:MODE](#) on page 285
- [CALCulate<t>:MARKer<m>:X](#) on page 286
- [CALCulate<t>:MARKer<m>:X:SLIMits<l>\[:STATe\]](#) on page 286
- [CALCulate<t>:MARKer<m>:X:SLIMits<l>:LEFT](#) on page 287
- [CALCulate<t>:MARKer<m>:X:SLIMits<l>:RIGHT](#) on page 287
- [CALCulate<t>:MARKer<m>:Y?](#) on page 288

For a detailed description of the commands not described below, see [Marker and deltamarkers](#) in the CAT mode.

[CALCulate<t>:MARKer:COUPled\[:STATe\]](#)..... 252

---

#### **CALCulate<t>:MARKer:COUPled[:STATe] <State>**

This command activates the selected marker as the coupling marker on the measurement traces.

#### **Suffix:**

`<t>`                                    1..n

**Parameters:**

&lt;State&gt; ON | OFF

**Example:**

CALC:MARK1:COUP ON

Activates marker 1 as the coupling marker on the measurement traces.

**13.6.2.7 Configuring and using measurement functions**

This chapter provides information on how to configure two-port measurements with the tracking generator. The structure follows the order of the actual operation sequence used when performing a measurement.

It also deals with configuring the Vector Voltmeter (Option R&S ZNH-K45).

To perform the actual measurement, use the commands described in [Chapter 13.6.2.4, "Performing and triggering the measurements"](#), on page 247.

- [Configuring the measurement port](#).....253
- [Selecting the measurement mode](#)..... 254
- [Calibrating the measurement](#).....254
- [Configuring the offset parameters](#).....256
- [Selecting the result display](#)..... 262
- [Selecting the measurement format](#)..... 262

**Configuring the measurement port**

The following chapter describes commands relate to the measurement port.

The suffix <p> selects the measurement port. It is in the range of <1..2>.

**List of commands**

- [MEASurement<p>:PORT](#) on page 289
- [SOURce:TG:POWer](#) on page 289
- [SOURce:TG:RANGe](#) on page 289

For a detailed description of the commands not described below, see [Configuring the measurement Port](#) in CAT mode.

[SOURce:TG:PORT](#)..... 253

**SOURce:TG:PORT <SourcePort>**

This command selects the measurement source port.

**Parameters:**

&lt;SourcePort&gt; PORT1 | PORT2

**Example:**

SOUR:TG:PORT 1

Selects port 1 as the measurement source.

### Selecting the measurement mode

The following commands define the measurement mode.

The suffix <t> selects the measurement trace. It is in the range of <1..4>.

#### List of commands

- [MEASurement<t>:MODE](#) on page 290  
For a detailed description of the command, see [Selecting the measurement mode](#) in CAT mode.

### Calibrating the measurement

The following commands define the calibration measurement.

The suffix <t> selects the measurement trace. It is in the range of <1..4>.

The suffix <p> selects the measurement port. It is in the range of <1..2>.

#### List of commands

- [\[SENSe:\]CORRection:COAX](#) on page 296
- [\[SENSe:\]CORRection:FREQuency:COAX](#) on page 296
- [\[SENSe:\]CORRection:LOSS:COAX](#) on page 296
- [\[SENSe:\]CORRection:RVELocity:COAX](#) on page 296
- [CALibration:MODE?](#) on page 298
- [CALibration:START?](#) on page 298
- [CALibration:STATus?](#) on page 299
- [CALCulate<t>:CALKit:USER:OFFSet<p>:LENGth](#) on page 297

For a detailed description of the commands not described below, see [Calibrating the measurement](#) in CAT mode.

<a href="#">[SENSe:]CORRection:CDATa?</a> .....	254
<a href="#">CALCulate&lt;t&gt;:CALKit:CONNector</a> .....	255
<a href="#">CALCulate&lt;t&gt;:CALKit:GENDER</a> .....	256
<a href="#">CALCulate&lt;t&gt;:CALKit:GENDER:PORT&lt;p&gt;</a> .....	256
<a href="#">CALCulate&lt;t&gt;:CALKit:SElect</a> .....	256

---

#### **[SENSe:]CORRection:CDATa?** <ErrorTerm>, <SourcePort>, <LoadPort>

This command reads system error correction data for calibration method and port combination <SourcePort>, <LoadPort>.

Calibration type	Calibration method	Available error terms
One-port normalization (reflection) using an open or a short standard	"Refl Norm Open" and "Refl Norm Short"	"REFLtrack"
Full one port	"Refl OSM"	"TRANSTRACK"
One-port, two-port normalization	"Trans Norm Both"	"DIRECTIVITY", "SRCMATCH", "REFLTRACK", "LOADMATCH", "TRANSTRACK"

**Parameters:**

<ErrorTerm>      DIRectivity | SRCMatch | REFLtrack | LOADmatch | TRANstrack  
String parameters describing the different error terms, depending on the current calibration method. Each term contains one complex value (real and imaginary part) for each sweep point. The parameter must be transferred in full length.

**DIRectivity**

Directivity at the <SourcePort>

**SRCMatch**

Source match at the <SourcePort>

**REFLtrack**

Reflection tracking at the <SourcePort>

**LOADmatch**

Load match at the <LoadPort>

**TRANstrack**

Transmission tracking between the <SourcePort> and the <LoadPort>

Range:      The error terms are dimensionless complex numbers.

<SourcePort>      Source port number.

<LoadPort>      Load port number. If the error term is not related to the load port, a dummy number can be used; e.g. CORR:CDAT  
'REFLtrack', 1, 0

**Usage:**      Query only

**CALCulate<t>:CALKit:CONNector <PortConnector>**

The command defines the port connector for calibration.

**Suffix:**

<t>      1..n

**Parameters:**

<PortConnector>      SMA | N50 | N75 | PC35 | PC292 | USER | PC7 | PC24 | PC185 | S7\_16 | BNC50 | BNC75 | WGUIDE

**Example:**      CALC1:CALK:CONN SMA  
Port connector is set to SMA.

**CALCulate<t>:CALKit:GENDer <PortGender>**

This command defines the gender of port connector on calibration kit.

**Suffix:**

<t> 1..n

**Parameters:**

<PortGender> FEMale | MALE | NGENder

**Example:**

CALC1:CALKit:GENd FEM

Port connector is set to female for the calibration kit.

**CALCulate<t>:CALKit:GENDer:PORT<p> <PortGender>**

This command defines the gender of port connector on instrument.

**Suffix:**

<t> 1..n

<p> 1..n

**Parameters:**

<PortGender> FEMale | MALE | NGENder

**Example:**

CALC1:CALKit:GENd FEM

Port connector is set to female for the instrument.

**CALCulate<t>:CALKit:SElect <CalKit>**

This command defines the calibration kit used for the calibration measurement.

**Suffix:**

<t> 1..n

**Parameters:**

<CalKit> Filename of the calibration kit.

**Example:**

CALC1:CALK:SEL "ZN-Z135-FEMALE"

Defines calibration kit "ZN-Z135-FEMALE" for the calibration measurement.

**Configuring the offset parameters**

The following commands configures the offset parameters.

The suffix <p> selects the port which the offset is applied. It is in the range of <1..2>.

The suffix <l> defines the evaluation range setting. It is in the range of <1..2>.

**List of commands**

<a href="#">[SENSe:]CORRection:OFFSet&lt;p&gt;:AUTO:LENGth.....</a>	257
<a href="#">[SENSe:]CORRection:OFFSet&lt;p&gt;:AUTO:LOSS.....</a>	257
<a href="#">[SENSe:]CORRection:OFFSet&lt;p&gt;:DCLoss.....</a>	257



[SENSe:]CORRection:OFFSet<p>:DELay.....	258
[SENSe:]CORRection:OFFSet<p>:ELIMits<l>:LEFT.....	258
[SENSe:]CORRection:OFFSet<p>:ELIMits<l>:RIGHT.....	258
[SENSe:]CORRection:OFFSet<p>:ELIMits<l>[:STATe].....	259
[SENSe:]CORRection:OFFSet<p>:FIRSt:FREQ.....	259
[SENSe:]CORRection:OFFSet<p>:FIRSt:LOSS.....	259
[SENSe:]CORRection:OFFSet<p>:LENGth.....	259
[SENSe:]CORRection:OFFSet<p>:MECHlength.....	260
[SENSe:]CORRection:OFFSet<p>:PERMittivity.....	260
[SENSe:]CORRection:OFFSet<p>:RESet.....	260
[SENSe:]CORRection:OFFSet<p>:SECond:ENABLE.....	261
[SENSe:]CORRection:OFFSet<p>:SECond:FREQ.....	261
[SENSe:]CORRection:OFFSet<p>:SECond:LOSS.....	261
[SENSe:]CORRection:OFFSet<p>:VELocity.....	261

---

### [SENSe:]CORRection:OFFSet<p>:AUTO:LENGth

This command sets the auto length function on the port.

**Suffix:**

<p> 1..n

**Example:**

SENS:CORR:OFFS2:AUTO:LENG

Applies the auto length function on port 2.

**Usage:**

Event

---

### [SENSe:]CORRection:OFFSet<p>:AUTO:LOSS

This command sets the auto length and loss function on the port.

**Suffix:**

<p> 1..n

**Example:**

SENS:CORR:OFFS2:AUTO:LOSS

Applies the auto length and loss function on port 2.

**Usage:**

Event

---

### [SENSe:]CORRection:OFFSet<p>:DCLoss <DcLoss>

This command sets the loss at DC of the offset at the port.

**Suffix:**

<p> 1..n

**Parameters:**

<DcLoss> Numeric value in the range of -200 dB to 200 dB.

Range: -200 to 200

\*RST: 0

Default unit: DB

**Example:**                `SENS:CORR:OFFS2:DCL 5`  
Sets the DC offset loss of port 2 to 5.

---

**[SENSe:]CORRection:OFFSet<p>:DELay <Offset Delay>**

This command sets the delay time offset of the port.

**Suffix:**

<p>                        1..n

**Parameters:**

<Offset Delay>            Numeric Value in the range of -1e9 s to 1e9 s.  
Range:            -1e9 s to 1e9  
Default unit: S

**Example:**                `SENS:CORR:OFFS2:DEL 0.001`  
Sets the delay time offset of port 2 to 1 ms.

---

**[SENSe:]CORRection:OFFSet<p>:ELIMits<l>:LEFT <EvaluationLimit>**

This command sets the left/start frequency of the evaluation range.

**Suffix:**

<p>                        1..n

<l>                        1..n

**Parameters:**

<EvaluationLimit>        Numeric value in the range of the instrument's operating frequency.  
Default unit: GHZ

**Example:**                `SENS:CORR:OFFS2:ELIM2:LEFT 10e6`  
Sets the left/start freq range of the evaluation range 2 to 10MHz.

---

**[SENSe:]CORRection:OFFSet<p>:ELIMits<l>:RIGHT <EvaluationLimit>**

This command sets the right/stop frequency of the evaluation range.

**Suffix:**

<p>                        1..n

<l>                        1..n

**Parameters:**

<EvaluationLimit>        Numeric value in the range of the instrument's operating frequency.  
Default unit: GHZ

**Example:**                `SENS:CORR:OFFS2:ELIM2:LEFT 10e6`  
Sets the right/stop freq range of the evaluation range 2 to 1GHz.

---

**[SENSe:]CORRection:OFFSet<p>:ELIMits<l>[:STATe] <State>**

This command enables/disables the evaluation range for the offset.

**Suffix:**

<p> 1..n

<l> 1..n

**Parameters:**

<State> ON | OFF

**Example:**

SENS:CORR:OFFS:ELIM:STAT ON  
Enables evaluation range 2 for the offset.

---

**[SENSe:]CORRection:OFFSet<p>:FIRSt:FREQ <FirstFreq>**

This command sets the first reference frequency for the offset loss.

**Suffix:**

<p> 1..n

**Parameters:**

<FirstFreq> Numeric value in the range of the instrument's operating frequency.  
Default unit: GHZ

**Example:**

SENS:CORR:OFFS1:FIR:FREQ 1.5e9  
Sets the first reference frequency of the offset loss at port 2 to 1.5GHz.

---

**[SENSe:]CORRection:OFFSet<p>:FIRSt:LOSS <LossAtFirstFreq>**

This command sets the offset loss at DC at the first reference frequency.

**Suffix:**

<p> 1..n

**Parameters:**

<LossAtFirstFreq> Numeric value in the range of -200 dB to 200 dB.  
Range: -200 to 200  
Default unit: DB

**Example:**

SENS:CORR:OFFS2:FIR:LOSS 5  
Sets the DC offset loss of port 2 to 5.

---

**[SENSe:]CORRection:OFFSet<p>:LENGth <ElectricLength>**

This command sets the electrical length offset of the port.

**Suffix:**

<p> 1..n

**Parameters:**

<ElectricLength> Numeric value in the range of -100 m to 100 m.  
 Range: -100 to 100  
 Default unit: M

**Example:**

`SENS:CORR:OFFS2:LENG 0.010`  
 Sets the electrical length offset of port 2 to 10mm.

**[SENSe:]CORRection:OFFSet<p>:MECHlength <MechanicalLength>**

This command sets the mechanical length offset of the port.

**Suffix:**

<p> 1..n

**Parameters:**

<MechanicalLength> Numeric value in the range of -100 m to 100 m.  
 Range: -100 to 100  
 Default unit: M

**Example:**

`SENS:CORR:OFFS1:MECH 0.010`  
 Sets the electrical length offset of port 1 to 10mm.

**[SENSe:]CORRection:OFFSet<p>:PERMittivity <Permittivity>**

This command sets the mechanical length offset of the port.

**Suffix:**

<p> 1..n

**Parameters:**

<Permittivity> Numeric value in the range of 1 to 1e6.  
 \*RST: 1.00062

**Example:**

`SENS:CORR:OFFS1:PERM 2.3`  
 Sets the permittivity of the offset of port 1 to 2.3.

**[SENSe:]CORRection:OFFSet<p>:RESet**

This command resets and clears the offset length and loss parameters for both ports.

**Suffix:**

<p> 1..n  
 The suffix <p> is irrelevant for this command.

**Example:**

`SENS:CORR:OFFS:RES`

**Usage:**

Event

Resets the offset parameters for both ports.

---

**[SENSe:]CORRection:OFFSet<p>:SECond:ENABle** <EnableSecond>

This command enables or disables the use of the second reference frequency for the offset loss approximation.

**Suffix:**

<p> 1..n

**Parameters:**

<EnableSecond> 1 | 0  
\*RST: 0

**Example:** SENS:CORR:OFFS2:SEC:ENAB 1

Enables the second reference frequency of the offset loss at port 2.

---

**[SENSe:]CORRection:OFFSet<p>:SECond:FREQ** <SecondFreq>

This command sets the second reference frequency for the offset loss.

**Suffix:**

<p> 1..n

**Parameters:**

<SecondFreq> Numeric value in the range of the instrument's operating frequency.  
Default unit: GHZ

**Example:** SENS:CORR:OFFS2:SEC:FREQ 1.5e9  
Sets the second reference frequency of the offset loss at port 2 to 1.5GHz.

---

**[SENSe:]CORRection:OFFSet<p>:SECond:LOSS** <LossAtSecondFreq>

This command sets the offset loss at DC at the second reference frequency.

**Suffix:**

<p> 1..n

**Parameters:**

<LossAtSecondFreq> Numeric value in the range of -200 dB to 200 dB.  
\*RST: 0  
Default unit: DB

**Example:** SENS:CORR:OFFS:SEC:LOSS 5

Sets the offset loss at the second reference frequency at port 2 to 5.

---

**[SENSe:]CORRection:OFFSet<p>:VELocity** <VelocityFactor>

This command sets the velocity factor of the offset at the port.

**Suffix:**

<p> 1..n

**Parameters:**

<VelocityFactor>      Numeric value in the range of 0.001 to 1.

**Example:**

SENS:CORR:OFFS1:VEL 0.66

Sets the velocity factor of the offset of port 1 to 0.66.

**Selecting the result display**

The following commands select the result display.

The suffix <t> selects the measurement trace. It is in the range of <1..4>.

**List of commands**

- [MEASurement<t>:FUNction:SElect](#) on page 294

For a detailed description of the command, see [Selecting and reading the measurement](#) in the CAT mode.

**Selecting the measurement format**

The following commands select the measurement format.

The suffix <t> selects the measurement trace. It is in the range of <1..4>.

**List of commands**

- [MEASurement<t>:FORMat](#) on page 293

For a detailed description of the commands not described below, see [Selecting and reading the measurement](#) in the CAT mode.

<a href="#">CALCulate&lt;t&gt;:TRACe:VSWR:MAX[:STATe]</a> .....	262
<a href="#">DISPlay&lt;t&gt;:GDELay:APERture:STEP</a> .....	263

**CALCulate<t>:TRACe:VSWR:MAX[:STATe] <State>**

This command turns the display of the maximum and average VSWR on and off.

Use [CALCulate<t>:TRACe:VSWR:AVG:RESult?](#) on page 293 and [CALCulate<t>:TRACe:VSWR:MAX:RESult?](#) on page 293 to query the corresponding results.

**Suffix:**

<t>                      1..n

**Parameters:**

<State>                ON | OFF

**ON**

Turns on the display of the maximum and average VSWR.

**OFF**

Turns off the display of the maximum and average VSWR.

\*RST:                OFF

**Example:**                    `CALC:TRAC:VSWR:MAX:STAT ON`  
 Displays the VSWR results.

---

### **DISPlay<t>:GDElay:APERture:STEP <ApertureStep>**

This command sets the aperture steps for the group delay measurement format.

**Suffix:**

<t>                            1..n

**Parameters:**

<ApertureStep>            Numeric value in the range from 1 to 630.

\*RST:                        10

## **13.6.3 Remote commands of the cable and antenna analyzer**

This section provides a detailed description of all remote control commands required to configure and perform measurements in Cable and Antenna Test (CAT) mode.

- [Configuring the horizontal axis](#).....263
- [Configuring the vertical axis](#).....267
- [Setting the bandwidth](#).....273
- [Performing measurements](#).....274
- [Working with traces](#).....275
- [Using markers](#).....279
- [Configuring and using measurement functions](#).....288

### **13.6.3.1 Configuring the horizontal axis**

The following commands configure the horizontal (frequency) axis of the active display.

The suffix <t> selects the measurement trace. It is in the range of <1..4>.

**List of commands**

<a href="#">[SENSe:]FREQuency:CENTer</a> .....	264
<a href="#">[SENSe:]FREQuency:CENTer:STEP</a> .....	264
<a href="#">[SENSe:]FREQuency:CENTer:STEP:LINK</a> .....	264
<a href="#">[SENSe:]FREQuency:SPAN</a> .....	264
<a href="#">[SENSe:]FREQuency:SPAN:AUTO</a> .....	265
<a href="#">[SENSe:]FREQuency:SPAN:FULL</a> .....	265
<a href="#">[SENSe:]FREQuency:START</a> .....	265
<a href="#">[SENSe:]FREQuency:STOP</a> .....	265
<a href="#">[SENSe:]FREQuency:SETTings:COUPling:ENABle</a> .....	266
<a href="#">CALCulate&lt;t&gt;:DTF:FREQuency:SPAN</a> .....	266
<a href="#">CALCulate&lt;t&gt;:DTF:DISTance:START</a> .....	267
<a href="#">CALCulate&lt;t&gt;:DTF:DISTance:STOP</a> .....	267

---

**[SENSe:]FREQuency:CENTer <CenterFrequency>**

This command defines the center frequency of the R&S ZNH.

In spectrum analyzer mode, the command also defines the measuring frequency for time domain measurements (span = 0).

**Parameters:**

<CenterFrequency> Range: Depends on the operating mode and is specified in the data sheet.  
\*RST: fmax /2 with fmax = maximum frequency  
Default unit: MHz

**Example:**

```
FREQ:CENT 100MHz
```

Defines a center frequency of 100 MHz.

---

**[SENSe:]FREQuency:CENTer:STEP <Stepsize>**

This command defines the center frequency step size.

**Parameters:**

<Stepsize> Range: 1 Hz to fmax  
\*RST: - (AUTO 0.1\*SPAN is switched on)  
Default unit: MHz

**Example:**

```
FREQ:CENT:STEP 120MHz
```

Defines a CF step size of 120 MHz.

---

**[SENSe:]FREQuency:CENTer:STEP:LINK <CouplingState>**

This command couples and decouples the center frequency step size to the span.

For time domain measurements, the command couples the step size to the resolution bandwidth.

**Parameters:**

<CouplingState> CENTerf | DIVTen | OFF  
**CENTerf**  
Sets the step size equal to the center frequency.  
**DIVTen**  
Couples the step size to the span (10 %).  
**OFF**  
Turns off the coupling (manual step size).  
\*RST: DIVTen

**Example:**

```
FREQ:CENT:STEP:LINK DIVT
```

Couples the step size to 10% of the span.

---

**[SENSe:]FREQuency:SPAN <FrequencySpan>**

This command defines the frequency span.



If you set a span of 0 Hz, the R&S ZNH starts a measurement in the time domain.

**Parameters:**

<FrequencySpan> Range: Specified in the data sheet.  
 \*RST: fmax with fmax = maximum frequency  
 Default unit: GHz

**Example:**

FREQ:SPAN 10MHz  
 Defines a span of 10 MHz.

**[SENSe:]FREQuency:SPAN:AUTO <State>**

This command turns on or off the automatic calculation of the ideal span.

**Parameters:**

<State> ON | OFF  
 \*RST: OFF

**Example:**

FREQ:SPAN:AUTO ON  
 Turns on the automatic span determination.

**[SENSe:]FREQuency:SPAN:FULL**

This command restores the full span.

This command is an event and therefore has no query and no \*RST value.

**Example:**

FREQ:SPAN:FULL  
 Restores full span.

**Usage:**

Event

**[SENSe:]FREQuency:STARt <StartFrequency>**

This command defines the start frequency for measurements in the frequency domain (span > 0).

**Parameters:**

<StartFrequency> Range: Depends on the operating mode and is specified in the datasheet.  
 \*RST: 0 Hz  
 Default unit: GHz

**Example:**

FREQ:STAR 20MHz  
 Defines a start frequency of 20 MHz.

**[SENSe:]FREQuency:STOP <StopFrequency>**

This command defines the stop frequency for measurements in the frequency domain (span > 0).

**Parameters:**

<StopFrequency> Range: Depends on the operating mode and is specified in the datasheet.

\*RST: fmax

Default unit: GHz

**Example:**

```
FREQ:STOP 2000MHz
```

Defines a stop frequency of 2 GHz.

**[SENSe:]FREQuency:SETTings:COUPling:ENABle <State>**

This command couples or decouples the frequency settings of the DTF measurement to the other Cable and Analyzer measurements.

**Parameters:**

<State>

**ON | 1**

Frequency settings are coupled. When you change the frequency or span in the DTF measurement, they also change in the other Cable and Analyzer measurements (reflection, transmission and cable loss).

**OFF | 0**

Frequency settings of the DTF measurement are independent. When you change the frequency or span in the DTF measurement, they do not change in the other VNA measurements (reflection, transmission and cable loss).

\*RST: ON

**Example:**

```
FREQ:SETT:COUP:ENAB OFF
```

Decouple frequency and span.

**CALCulate<t>:DTF:FREQuency:SPAN <State>**

This command sets whether a user defined cable model is used.

**Suffix:**

<t>

1..n

The suffix <t> is irrelevant for this command.

**Parameters:**

<State>

MANual | POINTs | AUTO

**MANual**

Frequency span in full manual mode, measurement range can enter ambiguous range.

**POINTs**

Frequency span in auto points mode. Points is automatically adjusted to meet minimum point requirement based on frequency span, to not be in ambiguous range.

**AUTO**

Frequency span in auto mode. Maximum span is limited to maintain unambiguity.

**Example:**                    `CALC:DTF:FREQ:SPAN man`  
Sets frequency span in full manual mode.

---

#### **CALCulate<t>:DTF:DIStance:StARt <DtfDistanceStart>**

This command defines the start distance of the cable measurement.

**Suffix:**

<t>                            1..n

**Parameters:**

<DtfDistanceStart>    Numeric value in the range from 3 m (10 ft) to 1500 m (4921 ft)  
The unit is either meter or feet, depending on your selection.  
\*RST:                    3 m (10 ft)  
Default unit: m

**Example:**                    `CALC:DTF:DISt:StAR 50m`  
Sets the starting point of the measurement to 50 m.

---

#### **CALCulate<t>:DTF:DIStance:StOP <DtfDistanceStop>**

This command defines the end point of the cable measurement.

**Suffix:**

<t>                            1..n

**Parameters:**

<DtfDistanceStop>    Numeric value in the range from 3 m (10 ft) to 1500 m (4921 ft)  
The unit is either meter or feet, depending on your selection.  
\*RST:                    1500 m (4921 ft)  
Default unit: m

**Example:**                    `CALC:DTF:DISt:StOP 500m`  
Sets the end point of the measurement to 500 m.

### 13.6.3.2 Configuring the vertical axis

The following commands configure the vertical (level) axis and level parameters of the active display.

The suffix <t> selects the measurement trace. It is in the range of <1..4>.

**List of commands**

<code>DISPlay[:WINDow]:TRACe&lt;t&gt;:Y[:SCALe]:ADJust</code> .....	268
<code>DISPlay[:WINDow]:TRACe&lt;t&gt;:Y[:SCALe]:RLEVel</code> .....	268
<code>DISPlay[:WINDow]:TRACe&lt;t&gt;:Y[:SCALe]:RPOSition</code> .....	268
<code>DISPlay&lt;t&gt;:LOSS:REFerence</code> .....	269
<code>DISPlay&lt;t&gt;:LOSS:REFerence:POSition</code> .....	269
<code>DISPlay&lt;t&gt;:LOSS:Y:SCALe</code> .....	269
<code>DISPlay&lt;t&gt;:MAGNitude:REFerence</code> .....	270
<code>DISPlay&lt;t&gt;:MAGNitude:REFerence:POSition</code> .....	270

DISPlay<t>:MAGNitude:Y:SCALe.....	270
DISPlay<t>:MAGNitude:Y:SPACing.....	271
DISPlay<t>:PHASe:REFerence.....	271
DISPlay<t>:PHASe:REFerence:POSition.....	271
DISPlay<t>:PHASe:UNWRap.....	272
DISPlay<t>:PHASe:Y:SCALe.....	272
DISPlay<t>:VSWR:Y:SCALe.....	272
DISPlay<t>:VSWR:Y:SCALe:MAXimum.....	273
DISPlay<t>:VSWR:Y:SCALe:MINimum.....	273

---

### DISPlay[:WINDow]:TRACe<t>:Y[:SCALe]:ADJust

This command automatically scales the vertical axis for optimum display results.

This command is an event and therefore has no query and no \*RST value.

**Suffix:**

<t> 1..n

**Example:**

DISP:TRAC:Y:ADJ  
Adjusts the y-axis.

**Usage:**

Event

---

### DISPlay[:WINDow]:TRACe<t>:Y[:SCALe]:RLEVel <RefLevel>

This command defines the reference level.

**Suffix:**

<t> 1..n

**Parameters:**

<RefLevel> Sets the reference level; the unit depends on UNIT<t>:POWer on page 246.

Range: Specified in the data sheet.

\*RST: -20 dBm

Default unit: dBm

**Example:**

DISP:TRAC:Y:RLEV -60dBm  
Sets the reference level to -60 dBm.

---

### DISPlay[:WINDow]:TRACe<t>:Y[:SCALe]:RPOSITION <RefLvlPosition>

This command defines the position of the reference level on the display grid.

First, you have to set a logarithmic scale for the vertical axis with DISPlay[:WINDow]:TRACe<t>:Y:SPACing on page 312. For a linear scale, you cannot modify the reference position.

**Suffix:**

<t> 1..n

**Parameters:**

<RefLvlPosition> Defines the reference position in %.  
 Range: 0 to 10  
 \*RST: 10

**Example:**

DISP:TRAC:Y:RPOS 5  
 Sets the reference position to the 5th grid line.

**DISPlay<t>:LOSS:REference <RefLevel>**

This command defines the reference level for the cable loss measurement format.

**Suffix:**

<t> 1..n

**Parameters:**

<RefLevel> Numeric value in the range from -100 dB to 100 dB.  
 \*RST: 0 dB  
 Default unit: dB

**Example:**

DISP:LOSS:REF 10

Defines a reference level of 10 dB.

**DISPlay<t>:LOSS:REference:POSition <RefPosition>**

This command defines the position of the reference value in the diagram for the cable loss measurement format.

Each step shifts the reference position one grid line up or down.

**Suffix:**

<t> 1..n

**Parameters:**

<RefPosition> Numeric value in the range from 0 to 10.  
 \*RST: 10

**Example:**

DISP:LOSS:REF:POS 5

Moves the reference to the fifth grid line from the bottom.

**DISPlay<t>:LOSS:Y:SCALE <DisplayRange>**

This command defines the display range of the vertical axis for the cable loss measurement format.

**Suffix:**

<t> 1..n

**Parameters:**

<DisplayRange> Numeric value in the range from 1 dB to 100 dB.  
 \*RST: 100 dB  
 Default unit: dB

**Example:**            `DISP:LOSS:Y:SCAL 20`  
                       Defines a display range of 20 dB

#### **DISPlay<t>:MAGNitude:REFerence <RefLevel>**

This command defines the reference value for the magnitude measurement format.

**Suffix:**

<t>                    1..n

**Parameters:**

<RefLevel>            Numeric value in the range from -80 dB to 30 dB  
                           \*RST:        0 dB  
                           Default unit: dB

**Example:**            `DISP:MAGN:REF -10`  
                           Defines a reference level of -10 dB.

#### **DISPlay<t>:MAGNitude:REFerence:POSition <RefPosition>**

This command defines the position of the reference value in the diagram for the magnitude measurement format.

Each step shifts the reference position one grid line up or down.

**Suffix:**

<t>                    1..n

**Parameters:**

<RefPosition>        Numeric value in the range from 0 to 10.  
                           \*RST:        10

**Example:**            `DISP:MAGN:REF:POS 5`  
                           Moves the reference to the fifth grid line from the bottom.

#### **DISPlay<t>:MAGNitude:Y:SCALe <DisplayRange>**

This command defines the display range of the vertical axis for the magnitude measurement format.

Note that you have to set a logarithmic scaling before you can use this command with [DISPlay<t>:MAGNitude:Y:SPACing](#) on page 271.

**Suffix:**

<t>                    1..n

**Parameters:**

<DisplayRange>        Numeric value in the range from 1 dB to 150 dB.  
                           The number you enter is rounded up to the next possible display range. For example, if you enter 9, the R&S ZNH automatically sets the display range to 10.  
                           \*RST:        100 dB  
                           Default unit: dB

**Example:**                    `DISP:MAGN:Y:SCAL 50 DB`  
 Defines a display range of 50 dB.

---

### **DISPlay<t>:MAGNitude:Y:SPACing <ScalingType>**

This command selects the scaling of the vertical axis for the magnitude measurement format.

**Suffix:**  
 <t>                            1..n

**Parameters:**  
 <ScalingType>                LINear | LOGarithmic

**LINear**  
 Selects a linear scale (%).

**LOGarithmic**  
 Selects a logarithmic scale (dB).

\*RST:                        LOGarithmic

**Example:**                    `DISP:MAGN:Y:SPAC LIN`  
 Selects linear scaling.

---

### **DISPlay<t>:PHASe:REFerence <RefLevel>**

This command sets the reference value for the phase measurement format.

**Suffix:**  
 <t>                            1..n

**Parameters:**  
 <RefLevel>                    Numeric value in the range from -100000° to 100000°.

\*RST:                        0 dB

**Example:**                    `DISP:MAGN:REF -10`  
 Sets the reference level to -10 dB

---

### **DISPlay<t>:PHASe:REFerence:POSition <RefPosition>**

This command defines the position of the reference value on the display for the phase measurement format.

Each step shifts the reference position one grid line up or down.

**Suffix:**  
 <t>                            1..n

**Parameters:**  
 <RefPosition>                Numeric value in the range from 0 to 10.

\*RST:                        10

**Example:** `DISP:LOSS:REF:POS 5`  
Sets the reference to the center of the display (i.e. the fifth grid line from the bottom).

### **DISPlay<t>:PHASe:UNWRap <State>**

This command removes the restriction limiting the value range to +/- 180°.

**Suffix:**

<t> 1..n

**Parameters:**

<State> ON | OFF  
\*RST: OFF

**Example:** `DISP:PHAS:UNWR ON`  
Activates the phase unwrap.

### **DISPlay<t>:PHASe:Y:SCALe <DisplayRange>**

This command defines the display range of the vertical axis for the phase measurement format.

**Suffix:**

<t> 1..n

**Parameters:**

<DisplayRange> Numeric value in the range from 90° to 100000°.  
\*RST: 360°

**Example:** `DISP:PHAS:Y:SCAL 180`  
Sets the display range of the phase measurement to 180°

### **DISPlay<t>:VSWR:Y:SCALe <DisplayRange>**

This command defines the bottom value of the vertical axis for the VSWR measurement format.

**Suffix:**

<t> 1..n

**Parameters:**

<DisplayRange> Numeric value in the range from 1.1 to 71.  
The number you enter is rounded up to the next possible display range. For example, if you enter 5, the R&S ZNH automatically sets the display range to 1...6.

\*RST: 1...21

**Example:** `DISP:VSWR:Y:SCAL 50`  
Defines a display range of 1...71.



**DISPlay<t>:VSWR:Y:SCALE:MAXimum** <DisplayRange>

This command defines the top value of the vertical axis for the VSWR measurement format.

**Suffix:**

<t> 1..n

**Parameters:**

<DisplayRange> Numeric value in the range from 1.1 to 71.  
\*RST: 21

**Example:**

DISP:VSWR:Y:SCALE:MAX 25  
Defines a top value of 25 for the vertical axis.

**DISPlay<t>:VSWR:Y:SCALE:MINimum** <DisplayRange>

This command defines the bottom value of the vertical axis for the VSWR measurement format.

**Suffix:**

<t> 1..n

**Parameters:**

<DisplayRange> Numeric value in the range from 1.0 to 70.  
\*RST: 1.0

**Example:**

DISP:VSWR:Y:SCALE:MIN 3  
Defines a bottom value of 3 for the vertical axis.

**13.6.3.3 Setting the bandwidth**

The following commands configure the filter bandwidths of the R&S ZNH. Note that both groups of commands (**BANDwidth** and **BWIDth**) are the same.

**List of commands**

[SENSe:]BWIDth[:RESolution].....	273
[SENSe:]BANDwidth[:RESolution].....	273
[SENSe:]BWIDth[:RESolution]:AUTO.....	274
[SENSe:]BANDwidth[:RESolution]:AUTO.....	274

**[SENSe:]BWIDth[:RESolution]** <ResolutionBW>**[SENSe:]BANDwidth[:RESolution]** <ResolutionBW>

This command defines the resolution bandwidth.

**Parameters:**

<ResolutionBW> Range: 1 Hz to 3 MHz  
\*RST: - (AUTO is set to ON)  
Default unit: GHz

**Example:** BAND 100 kHz  
Sets the resolution bandwidth to 100 kHz.

---

**[SENSe:]BWIDth[:RESolution]:AUTO <State>**  
**[SENSe:]BANDwidth[:RESolution]:AUTO <State>**

This command couples and decouples the resolution bandwidth to the span.

**Parameters:**  
<State> ON | OFF  
\*RST: ON

**Example:** BAND:AUTO OFF  
Decouples the resolution bandwidth from the span.

### 13.6.3.4 Performing measurements

The following commands control the actual measurement process.

#### List of commands

<a href="#">INITiate:CONTinuous</a> .....	274
<a href="#">[SENSe:]SWEep:POINts</a> .....	274

---

**INITiate:CONTinuous <State>**

This command selects the sweep mode.

**Parameters:**  
<State> ON | OFF  
**ON**  
Selects continuous sweeps.  
**OFF**  
Selects single sweep.  
\*RST: ON

**Example:** INIT:CONT OFF  
Turns on single sweep mode.

---

**[SENSe:]SWEep:POINts <NrofPoints>**

This command queries the number of measurement points in a single sweep.

This command is a query and therefore has no \*RST value.

**Parameters:**  
<NrofPoints> Returns the number of sweep points.

**Example:** SWE:POIN?  
Returns the number of sweep points.

### 13.6.3.5 Working with traces

The following commands set up the trace and the various functions associated with it, e.g. trace mathematics or the selection of the detector.

The suffix <t> selects the measurement trace. It is in the range of <1..4>.

#### List of commands

CALCulate<t>:MATH:COPY:MEMory.....	275
DISPlay[:WINDow]:TRACe<t>:MEMory[:STATe].....	275
DISPlay[:WINDow]:TRACe<t>:MODE.....	276
FORMat[:DATA].....	276
FORMat:BORDER.....	277
MEASurement<t>:ISUP.....	277
MEASurement<t>:ISUP:APER.....	277
MEASurement<t>:ISUP:APER:AUTO.....	277
UNIT<t>:LENGTH.....	278
TRACe<t>[:DATA]?.....	278
TRACe<t>[:DATA]:MEMory?.....	279

---

#### CALCulate<t>:MATH:COPY:MEMory [<MemorySlot>]

This command stores the selected trace into the memory trace of the R&S ZNH.

This command is an event and therefore has no query and no \*RST value.

##### Suffix:

<t> 1..n

##### Parameters:

<MemorySlot>

##### Example:

CALC1:MATH:COPY:MEM

##### Usage:

Setting only

Copies trace1 into the memory.

---

#### DISPlay[:WINDow]:TRACe<t>:MEMory[:STATe] <State>

This command turns the memory trace on and off.

##### Suffix:

<t> 1..n

##### Parameters:

<State>

ON | OFF

\*RST: OFF

##### Example:

DISP:TRAC:MEM ON

Activates the memory trace.

**DISPlay[:WINDow]:TRACe<t>:MODE** <DisplayMode>

This command selects the trace mode.

If you are using the average, max hold or min hold trace mode, you can set the number of measurements with [SENSe:]SWEep:COUNT<SweepCount>. Note that synchronization to the end of the average count is possible only in single sweep mode.

**Suffix:**

<t> 1..n

**Parameters:**

<DisplayMode> WRITe | AVERAge | MINHold | MAXHold | VIEW | FREeze | INFinite

\*RST: WRITe

**Example:**

SWE:CONT OFF

SWE:COUN 16

Turn on single sweep mode and sets the number of measurements to 16.

DISP:TRAC:MODE MAXH

Activates MAXHold mode for the trace.

INIT;\*WAI

Starts the measurement and waits for the end of the 16 sweeps.

**FORMat[:DATA]** <Format>[, <>]

This command selects the data format that is used for transmission of trace data from the R&S ZNH to the controlling computer.

Note that the command has no effect for data that you send to the R&S ZNH. The R&S ZNH automatically recognizes the data it receives, regardless of the format.

**Parameters:**

<Format> ASCii | REAL

**ASCii**

Returns the data in ASCII format, separated by commas.

**REAL**

Returns the data as 32-bit IEEE 754 floating point numbers in the "definite length block format".

\*RST: ASCii

In REAL, 32 format, a string of return values would look like:

#42424<value 1><value 2>...<value n> with

#4 - representing the number of digits of the following number of data bytes (= 4 in this example);

2524 - representing the number of following data bytes (2524, corresponds to the 711 sweep points of the R&S ZNH.

<value> - representing 4-byte floating point value.

**Example:**

FORM ASC

Selects the ASCII data format.

---

**FORMat:BORDER** <TransferOrder>

This command selects the format of binary data.

**Parameters:**

<TransferOrder>      NORMAl | SWAPped

**NORMAl**

The most significant byte is transferred first big endian).

**SWAPped**

The least significant byte is transferred first (little endian).

\*RST:            SWAPped

**Example:**

FORM:BORD NORM

Changes the byte order to normal mode.

---

**MEASurement<t>:ISUP** <State>

This command turns interference suppression on and off.

**Suffix:**

<t>                    1..n

**Parameters:**

<State>              ON | OFF

**ON**

The interference suppression is turned on.

**OFF**

The interference suppression is turned off.

\*RST:            OFF

**Example:**

MEAS:ISUP ON

Turns interference suppression on.

---

**MEASurement<t>:ISUP:APER** <ApertureStep>

This command defines the aperture size for interference suppression.

**Suffix:**

<t>                    1..n

**Parameters:**

<ApertureStep>      Numeric value that defines the aperture.

\*RST:            1

**Example:**

MEAS:ISUP:APER 0.8

Sets an aperture size of 0.8.

---

**MEASurement<t>:ISUP:APER:AUTO** <State>

This aperture size is set auto for interference suppression.

**Suffix:**  
<t> 1..n

**Parameters:**  
<State> **ON**  
The aperture size is set auto.  
**OFF**  
The aperture size is set manual.

**Example:** MEAS:ISUP:APER:AUTO  
The aperture size is set auto.

---

**UNIT<t>:LENGth** <LengthUnit>

This command selects the length unit.

**Suffix:**  
<t> 1..n

**Parameters:**  
<LengthUnit> METer | FEET  
**METer**  
Selects meter as the length unit.  
**FEET**  
Selects feet as the length unit.  
\*RST: METer

**Example:** UNIT:LENGth FEET  
Selects feet as the length unit.

---

**TRACe<t>[:DATA]?** [<arg0>]

This command queries the trace data of the current measurement.

It also transfers data from a file to a particular trace.

With the command [FORMat \[:DATA\]](#) on page 276, you can set the data format.

**Suffix:**  
<t> 1..n

**Parameters:**  
<arg0> TRACe1 | TRACe2 | TRACe3 | TRACe4 | LIST  
**TRACe1**  
Queries the data of trace 1.  
**TRACe2**  
Queries the data of trace 2.  
**TRACe3**  
Queries the data of trace 1.  
**TRACe4**  
Queries the data of trace 1.

**LIST**

Queries the peak list of the measurement.

The R&S ZNH returns 711 values. Each value corresponds to one pixel of a trace.

The unit depends on the measurement and the unit you have set with `UNIT<1..2>:POWER`.

Note: If you use the auto peak detector, the command reads out positive peak values only.

**Example:** TRAC:DATA? TRACE1  
Reads out the data for trace 1.

**Usage:** Query only

**TRACe<t>[:DATA]:MEMory? [<arg0>]**

Read memory trace data.

**Suffix:**

<t> 1..n

**Parameters:**

<arg0> TRACe1 | TRACe2 | TRACe3 | TRACe4

**Example:**

CALC:MATH:COPY:MEM  
TRAC:MEM?

Copy trace1 to memory1 and read memory1 trace data.

**Example:**

CALC:MATH2:COPY:MEM  
TRAC:MEM? TRACE2

Copy trace2 to memory2 and read memory2 trace data.

**Usage:** Query only

**13.6.3.6 Using markers**

The following commands control the operation of marker and delta markers.

- [Marker and deltamarkers](#)..... 279

**Marker and deltamarkers**

The following commands are for setting and controlling markers and deltamarkers.

The suffix <m> selects the marker. It is in the range of <1..6>.

The suffix <l> selects the limit line. It is in the range of <1..2>.

The suffix <t> selects the measurement trace. It is in the range of <1..4>.

**List of commands**

CALCulate<t>:DELTAmarker<m>[:STATE]	280
CALCulate<t>:DELTAmarker<m>:AOFF	280
CALCulate<t>:DELTAmarker<m>:MAXimum[:PEAK]	281

CALCulate<t>:DELTamarker<m>:MAXimum:NEXT.....	281
CALCulate<t>:DELTamarker<m>:MINimum[:PEAK].....	281
CALCulate<t>:DELTamarker<m>:X.....	282
CALCulate<t>:DELTamarker<m>:X:RELative.....	282
CALCulate<t>:DELTamarker<m>:Y?.....	282
CALCulate<t>:MARKer<m>[:STATe].....	283
CALCulate<t>:MARKer<m>:AOFF.....	283
CALCulate<t>:MARKer<m>:FUNction:STRack[:STATe].....	284
CALCulate<t>:MARKer<m>:MAXimum[:PEAK].....	284
CALCulate<t>:MARKer<m>:MAXimum:NEXT.....	284
CALCulate<t>:MARKer<m>:MINimum[:PEAK].....	285
CALCulate<t>:MARKer:MODE.....	285
CALCulate<t>:MARKer<m>:X.....	286
CALCulate<t>:MARKer<m>:X:SLIMits<l>[:STATe].....	286
CALCulate<t>:MARKer<m>:X:SLIMits<l>:LEFT.....	287
CALCulate<t>:MARKer<m>:X:SLIMits<l>:RIGHT.....	287
CALCulate<t>:MARKer<m>:Y?.....	288

---

### CALCulate<t>:DELTamarker<m>[:STATe] <State>

This command turns delta markers on and off.

If you set the suffix at DELTmarker to 1, or use no suffix, the R&S ZNH interprets this as delta marker 2 because the first marker has to be a normal marker. If more than one normal marker (2 to 6) is already active, the command turns these markers into delta markers. If no delta marker is active yet, the command activates the delta marker and positions it on the trace maximum.

#### Suffix:

<t> 1..n

<m> 1..n

#### Parameters:

<State> ON | OFF

\*RST: OFF

#### Example:

CALC:DELT3 ON

Turns on delta marker 3 or turn marker 3 into a delta marker.

---

### CALCulate<t>:DELTamarker<m>:AOFF

This command turns off all active delta markers.

This command is an event and therefore has no query and no \*RST value.

#### Suffix:

<t> 1..n

<m> 1..n

#### Example:

CALC:DELT:AOFF

Turns off all delta markers.



**Usage:** Event

---

#### **CALCulate<t>:DELTamarker<m>:MAXimum[:PEAK]**

This command positions a delta marker on the current trace maximum.

If necessary, the corresponding delta marker is activated first.

This command is an event and therefore has no \*RST value and no query.

**Suffix:**

<t> 1..n

<m> 1..n

**Example:** `CALC:DELT3:MAX`  
 Moves delta marker 3 to the maximum peak.

**Usage:** Event

---

#### **CALCulate<t>:DELTamarker<m>:MAXimum:NEXT**

This command positions a delta marker on the next smaller trace maximum.

If necessary, the corresponding delta marker is activated first.

This command is an event and therefore has no \*RST value and no query.

**Suffix:**

<t> 1..n

<m> 1..n

**Example:** `CALC:DELT2:MAX:NEXT`  
 Moves delta marker 2 to the next smaller maximum peak.

**Usage:** Event

---

#### **CALCulate<t>:DELTamarker<m>:MINimum[:PEAK]**

This command positions a delta marker on the current trace minimum.

If necessary, the corresponding delta marker is activated first.

This command is an event and therefore has no \*RST value and no query.

**Suffix:**

<t> 1..n

<m> 1..n

**Example:** `CALC:DELT3:MIN`  
 Moves delta marker 3 to the trace minimum.

**Usage:** Event

**CALCulate<t>:DELTamarker<m>:X <FrequencyOrTime>**

This command positions a delta marker on a particular coordinate on the horizontal axis.

Note that it is possible to place the marker outside the visible trace. In that case, this value is invalid.

If necessary, the corresponding delta marker is activated first.

**Suffix:**

<t> 1..n

<m> 1..n

**Parameters:**

<FrequencyOrTime> Numeric value that indicates the coordinate on the horizontal axis.

Range: Maximum span.

Default unit: GHz

**Example:**

```
CALC:DELT:MOD REL
```

Delta marker positions are relative to marker 1.

```
CALC:DELT2:X 10.7MHz
```

Positions delta marker 2 10.7 MHz to the right of marker 1.

```
CALC:DELT2:X?
```

```
CALC:DELT2:X:REL?
```

Queries the absolute and relative position of delta marker 2.

**CALCulate<t>:DELTamarker<m>:X:RELative <FrequencyOrTime>**

This command positions a delta marker on a position relative to the reference marker.

If necessary, the corresponding delta marker is activated first.

**Suffix:**

<t> 1..n

<m> 1..n

**Parameters:**

<FrequencyOrTime> Defines the distance of the marker to the reference marker.

Range: Depends on the current scaling of the horizontal axis.

Default unit: GHz

**Example:**

```
CALC:DELT3:X:REL 5 kHz
```

Sets the delta marker at a distance of 5 kHz to the reference position.

**CALCulate<t>:DELTamarker<m>:Y?**

This command queries the vertical position of a delta marker. The result is always a relative value in relation marker 1.

If necessary, the corresponding delta marker is activated first.

To get a valid result, you have to perform a complete sweep with synchronization to the sweep end between activating the delta marker and reading out the result. This is only possible in single sweep mode.

In spectrum analyzer mode, the unit depends on the unit you have set and the scaling of the vertical axis.

Parameter or measuring functions	Output unit
DBM   DBPW   DBUV   DBMV   DBUA	dB (lin/log)
WATT   VOLT   AMPere	dB (lin), % (log)

**Suffix:**

<t> 1..n

<m> 1..n

**Example:**

```
INIT:CONT OFF
```

```
CALC:DELT2 ON
```

Turns on single sweep mode and delta marker 2.

```
INIT;*WAI
```

Starts a sweep and waits for its end.

```
CALC:DELT2:Y?
```

Queries the position of delta marker 2.

**Usage:**

Query only

**CALCulate<t>:MARKer<m>[:STATe] <State>**

This command turns markers on and off.

If you do not use a suffix at MARKer, marker 1 is selected. If one or more delta markers (2 to 6) are already active, the command turns these delta markers into normal markers.

**Suffix:**

<t> 1..n

<m> 1..n

**Parameters:**

<State> ON | OFF

```
*RST: OFF
```

**Example:**

```
CALC:MARK3 ON
```

Turns on marker 3.

**CALCulate<t>:MARKer<m>:AOFF**

This command turns off all active markers, delta markers and active marker measurement functions.

This command is an event and therefore has no query and no \*RST value.

**Suffix:**

<t> 1..n

<m> 1..n

**Example:** CALC:MARK:AOFF  
Switches off all markers.

**Usage:** Event

**CALCulate<t>:MARKer<m>:FUNction:STRack[:STATe] <State>**

This command turns marker tracking on and off.

**Suffix:**

<t> 1..n

<m> 1..n

**Parameters:**

<State> ON | OFF | 1 | 0  
\*RST: OFF

**Example:** CALC:MARK:FUNC:STR ON  
Turn on marker tracking.

**CALCulate<t>:MARKer<m>:MAXimum[:PEAK]**

This command positions a marker on the current trace maximum.

If necessary, the corresponding marker is activated first.

This command is an event and therefore has no \*RST value and no query.

**Suffix:**

<t> 1..n

<m> 1..n

**Example:** CALC:MARK2:MAX  
Moves marker 2 to the maximum peak.

**Usage:** Event

**CALCulate<t>:MARKer<m>:MAXimum:NEXT**

This command positions a marker on the next smaller trace maximum.

If necessary, the corresponding marker is activated first.

This command is an event and therefore has no \*RST value and no query.

**Suffix:**

<t> 1..n

<m> 1..n

**Example:** CALC:MARK2:MAX:NEXT  
Moves marker 2 to the next smaller maximum peak.

**Usage:** Event

### CALCulate<t>:MARKer<m>:MINimum[:PEAK]

This command positions a marker on the current trace minimum.

If necessary, the corresponding marker is activated first.

This command is an event and therefore has no \*RST value and no query.

**Suffix:**

<t> 1..n

<m> 1..n

**Example:** CALC:MARK2:MIN  
Moves marker 2 to the trace minimum.

**Usage:** Event

### CALCulate<t>:MARKer:MODE <MarkerFormat>

This command selects the type of information a marker shows.

**Suffix:**

<t> 1..n

**Parameters:**

<MarkerFormat> NORMal | RPDB | RPL | RSCalar | IMPedance | ADMittance | NIMPedance | NADMittance | SWR | GDELay

See table below for supported parameters.

\*RST: NORMal

ADMittance	admittance in complex format (real + imaginary)
IMPedance	impedance in complex format (real + imaginary)
NADMittance	standardized admittance in complex format (real + imaginary)
NIMPedance	standardized impedance in complex format (real + imaginary)
NORMal	normal marker
RPDB	reflection coefficient in complex format (magnitude (dB) + phase)
RPL	reflection coefficient in complex format (magnitude (lin) + phase)
RSCalar	reflection coefficient in complex format (real + imaginary)

SWR	standing wave ratio
GDELAY	group delay

---

**CALCulate<t>:MARKer<m>:X <FrequencyOrTime>**

This command positions a marker on a particular coordinate on the horizontal axis.

If one or more delta markers (2 to 6) are already active, the command turns these delta markers into normal markers.

Note that it is possible to place the marker outside the visible trace. In that case, this value is invalid.

If necessary, the corresponding delta marker is activated first.

**Suffix:**

<t> 1..n

<m> 1..n

**Parameters:**

<FrequencyOrTime> Indicates the coordinate on the horizontal axis.  
The unit in spectrum analyzer mode depends on the measurement, e.g. Hz for measurements in the frequency domain and seconds for measurements in the time domain.

Range: Maximum span.

Default unit: GHz

**Example:**

`CALC:MARK2:X 10.7MHz`

Positions marker 2 to frequency 10.7 MHz.

---

**CALCulate<t>:MARKer<m>:X:SLIMits<l>[:STATe] <State>**

This command turns marker search limits on and off.

The search limit restricts the evaluation range of the trace when "set marker" functions are performed. For example, marker set to peak with command `CALCulate<t>:MARKer<m>:MAXimum[:PEAK]` on page 284 sets the marker only at the peak of the trace within the search limit.

**Suffix:**

<t> 1..n

<m> 1..n

<l> 1..n

**Parameters:**

<State> ON | OFF

\*RST: OFF

**Example:**

See `CALCulate<t>:MARKer<m>:X:SLIMits<l>:RIGHT` on page 287.

**CALCulate<t>:MARKer<m>:X:SLIMits<l>:LEFT <SearchLimit>**

This command defines the left limit of the marker search range.

To use the command, you first have to turn on search limits with [CALCulate<t>:MARKer<m>:X:SLIMits<l>\[:STATe\]](#) on page 286.

**Suffix:**

<t>	1..n
<m>	1..n
<l>	1..n

**Parameters:**

<SearchLimit>	Sets the left marker search limit. The unit in the spectrum analyzer mode depends on the measurement, e.g. Hz for measurements in the frequency domain and seconds for measurements in the time domain. Range: Maximum span. *RST: – (is set to the left diagram border when switching on search limits) Default unit: GHz
---------------	--

**Example:** See [CALCulate<t>:MARKer<m>:X:SLIMits<l>:RIGHT](#) on page 287.

**CALCulate<t>:MARKer<m>:X:SLIMits<l>:RIGHT <SearchLimit>**

This command defines the right limit of the marker search range.

To use the command, you first have to turn on search limits with [CALCulate<t>:MARKer<m>:X:SLIMits<l>\[:STATe\]](#) on page 286.

**Suffix:**

<t>	1..n
<m>	1..n
<l>	1..n

**Parameters:**

<SearchLimit>	Sets the right marker search limit. The unit depends on the measurement, e.g. Hz for measurements in the frequency domain and seconds for measurements in the time domain. Range: Maximum span. *RST: – (is set to the right diagram border when switching on search limits) Default unit: GHz
---------------	--

**Example:**            `CALC:MARK:X:SLIM ON`  
                          `CALC:MARK:X:SLIM:LEFT 10MHz`  
                          `CALC:MARK:X:SLIM:RIGH 100MHz`  
                          Turns on search limits and defines a search range from 10 MHz  
                          to 100 MHz.

---

### **CALCulate<t>:MARKer<m>:Y?**

This command queries the absolute vertical position of a marker.

If necessary, the corresponding marker is activated first.

To get a valid result, you have to perform a complete sweep with synchronization to the sweep end between activating the delta marker and reading out the result. This is only possible in single sweep mode.

The unit of the return value depends on `UNIT<1..2>:POWer`.

#### **Suffix:**

<t>                    1..n

<m>                    1..n

**Example:**            `INIT:CONF OFF`  
                          `CALC:MARK2 ON`  
                          Turns on single sweep mode and marker 2.  
                          `INIT;*WAI`  
                          Starts a sweep and waits for the end.  
                          `CALC:MARK2:Y?`  
                          Queries the position of marker 2.

**Usage:**                Query only

### **13.6.3.7 Configuring and using measurement functions**

This chapter provides information on how to configure two-port measurements with the tracking generator. The structure follows the order of the actual operation sequence used when performing a measurement:

To perform the actual measurement, use the commands described in [Chapter 13.6.3.4, "Performing measurements"](#), on page 274.

- [Configuring the measurement Port](#)..... 288
- [Selecting the cable characteristics](#)..... 289
- [Selecting the measurement mode](#)..... 290
- [Selecting and reading the measurement](#)..... 291
- [Calibrating the measurement](#)..... 295
- [Working with a DTF list](#)..... 300

#### **Configuring the measurement Port**

The following chapter describes commands relate to the measurement port.

The suffix <p> selects the measurement port. It is in the range of <1..2>.



**List of commands**

<a href="#">MEASurement&lt;p&gt;:PORT</a> .....	289
<a href="#">SOURce:TG:POWer</a> .....	289
<a href="#">SOURce:TG:RANGe</a> .....	289

**MEASurement<p>:PORT <PortNumber>**

This command selects the measurement port.

**Suffix:**

<p>                    1..n

**Parameters:**

<PortNumber>        Numeric value in the range from 1 to 2.

\*RST:                1

**Example:**

MEAS:PORT 1

Selects port 1.

**SOURce:TG:POWer <TgOutputLevel>**

This command defines the absolute output level of the tracking generator.

**Parameters:**

<TgOutputLevel>    Numeric value in the range from 0 dBm to -25 dBm.

\*RST:                0

Default unit: dBm

**Example:**

SOUR:TG:POW -20

Defines an output level of -20 dBm.

**SOURce:TG:RANGe <arg0>**

This command defines the tracking generator (TG) power range mode. For more information, see the datasheet for details.

**Parameters:**

<arg0>                LEVeled | MAXimum

**LEVeled**

Selects the TG power range to leveled.

**MAXimum**

Selects the TG power range to maximum.

**Selecting the cable characteristics**

The following commands define the cable characteristics for the cable you are testing.

The suffix <t> selects the measurement trace. It is in the range of <1..4>.

**List of commands**

<a href="#">CALCulate&lt;t&gt;:DTF:CABLE:LENGth</a> .....	290
<a href="#">CALCulate&lt;t&gt;:DTF:CABLE:PRESet</a> .....	290

**CALCulate<t>:DTF:CABLE:LENGth <CableLength>**

This command sets the cable length.

**Suffix:**

<t>                    1..n

**Parameters:**

<CableLength>        Numeric value in the range from 3 m to 1500 m.  
                          \*RST:            20 m  
                          Default unit: M

**Example:**

`CALCulate:DTF:CAB:LENG 2 M`  
 Sets the cable length to 2 meters.

**CALCulate<t>:DTF:CABLE:PRESet <CableModel>**

This command selects the cable model.

**Suffix:**

<t>                    1..n

**Parameters:**

<CableModel>        String containing the filename of the cable model.

**Example:**

`CALC:DTF:CAB:PRES '5088-HLFR.CBLMOD'`  
 Selects the cable model from the file 5088-HLFR.CBLMOD

**Selecting the measurement mode**

The following commands select the measurement mode.

The suffix <t> selects the measurement trace. It is in the range of <1..4>.

**List of commands**

<a href="#">MEASurement&lt;t&gt;:MODE</a> .....	290
---	-----

**MEASurement<t>:MODE <MeasMode>**

This command selects the measurement mode.

**Suffix:**

<t>                    1..n

**Parameters:**

<MeasMode>        VECTor | VVMeter | DTFault | REFlection | TRANsmission |  
 LOSS | TDRreflect

**VECTor**

Selects the vector network analyzer measurement.

**VVMeter**

Selects the vector voltmeter measurement.

**DTFault**

Selects the distance-to-fault measurement.

**REFlection**

Selects the reflection measurement (S11, S22) depending on [MEASurement<p>:PORT](#) on page 289.

**TRANsmission**

Selects the transmission measurement (S21, S12) depending on [MEASurement<p>:PORT](#) on page 289.

**LOSS**

Selects the cable loss measurement.

**TDReflect**

Selects the time domain reflectometry measurement.

\*RST: REFlection

**Example:**

```
MEAS:MODE LOSS
```

Activates cable loss measurement.

**Selecting and reading the measurement**

The following commands select the measurement format and query various measurement results in CAT mode.

The suffix <t> selects the measurement trace. It is in the range of <1..4>.

**List of commands**

<a href="#">CALCulate&lt;t&gt;:TRACe:VSWR:MAX[:STATe]</a> .....	291
<a href="#">CALCulate&lt;t&gt;:TRACe:CABLe:LENGth:RESult?</a> .....	292
<a href="#">CALCulate&lt;t&gt;:TRACe:CABLe:LENGth[:STATe]</a> .....	292
<a href="#">CALCulate&lt;t&gt;:TRACe:CABLe:LOSS:RESult?</a> .....	292
<a href="#">CALCulate&lt;t&gt;:TRACe:LIMit:VSWR:FAIL?</a> .....	293
<a href="#">CALCulate&lt;t&gt;:TRACe:VSWR:AVG:RESult?</a> .....	293
<a href="#">CALCulate&lt;t&gt;:TRACe:VSWR:MAX:RESult?</a> .....	293
<a href="#">MEASurement&lt;t&gt;:FORMat</a> .....	293
<a href="#">MEASurement&lt;t&gt;:FUNCTion:SELect</a> .....	294

**CALCulate<t>:TRACe:VSWR:MAX[:STATe] <State>**

This command turns the display of the maximum and average VSWR on and off.

Use [CALCulate<t>:TRACe:VSWR:AVG:RESult?](#) on page 293 and [CALCulate<t>:TRACe:VSWR:MAX:RESult?](#) on page 293 to query the corresponding results.

**Suffix:**

&lt;t&gt; 1..n

**Parameters:**

&lt;State&gt; ON | OFF

**ON**

Turns on the display of the maximum and average VSWR.

**OFF**

Turns off the display of the maximum and average VSWR.

\*RST: OFF

**Example:**

CALC:TRAC:VSWR:MAX:STAT ON

Displays the VSWR results.

**CALCulate<t>:TRACe:CABLe:LENGth:RESult?**

This command queries the results of the electrical cable length.

This command is a query and therefore has no \*RST value.

**Suffix:**

&lt;t&gt; 1..n

**Example:**

CALC:TRAC:CABL:LENG:RES?

Queries the measurement result of the electrical cable length.

**Usage:**

Query only

**CALCulate<t>:TRACe:CABLe:LENGth[:STATe] <State>**

This command turns the electrical length format on and off.

**Suffix:**

&lt;t&gt; 1..n

**Parameters:**

&lt;State&gt; ON | OFF

\*RST: OFF

**Example:**

CALC:TRAC:CABL:LENG ON

Activates the electrical cable length.

**CALCulate<t>:TRACe:CABLe:LOSS:RESult?**

This command queries the cable loss measurement result.

The numeric suffix at CALCulate is irrelevant for this command.

**Suffix:**

&lt;t&gt; 1..n

**Example:**

CALC:TRAC:CABL:LOSS:RES?

Returns the cable loss in dB.

**Usage:** Query only

---

#### **CALCulate<t>:TRACe:LIMit:VSWR:FAIL?**

This command queries the results of the limit check for the VSWR measurement format.

This command is a query and therefore has no \*RST value.

**Suffix:**

<t> 1..n

**Example:** `CALC:TRAC:LIM:VSWR:FAIL?`  
Queries the results of the limit check.

**Usage:** Query only

---

#### **CALCulate<t>:TRACe:VSWR:AVG:RESult?**

This command queries the average VSWR measurement result.

The command is available when the calculation of the VSWR has been turned on with [CALCulate<t>:TRACe:VSWR:MAX\[:STATe\]](#) on page 262.

**Suffix:**

<t> 1..n

**Example:** `CALC:TRAC:VSWR:MAX:STAT ON`  
`CALC:TRAC:VSWR:AVG:RES?`  
Queries the average VSWR.

**Usage:** Query only

---

#### **CALCulate<t>:TRACe:VSWR:MAX:RESult?**

This command queries the maximum VSWR measurement result.

The command is available when the calculation of the VSWR has been turned on with [CALCulate<t>:TRACe:VSWR:MAX\[:STATe\]](#) on page 262.

**Suffix:**

<t> 1..n

**Example:** `CALC:TRAC:VSWR:MAX:STAT ON`  
`CALC:TRAC:VSWR:MAX:RES?`  
Queries the maximum VSWR.

**Usage:** Query only

---

#### **MEASurement<t>:FORMat <MeasFormat>**

This command selects the measurement format.

**Suffix:**

&lt;t&gt; 1..n

**Parameters:**

&lt;MeasFormat&gt; MAGNitude | PHASe | VSWR | REFLection | SMITH | LOSS | GDELay | VVMeter | VVMReflect | MLINear | REAL | IMAGinary | POLar

**MAGNitude**

Selects the magnitude measurement format.

**PHASe**

Selects the phase measurement format.

**VSWR**

Selects the VSWR measurement format.

**REFLection**

Selects the reflection coefficient measurement format.

**SMITH**

Selects the smith chart measurement format.

**LOSS**

Selects the cable loss measurement format.

**GDELay**

Selects the group delay loss measurement format.

**VVMeter**

Selects the voltmeter measurement format.

**MLINear**

Selects the linear magnitude measurement format.

**REAL**

Selects the real part of complex measurement format.

**IMAGinary**

Selects the imaginary part of complex measurement format.

**POLar**

Selects the polar measurement format.

\*RST: MAGNitude

**Example:**

MEAS:FORM SMIT

Displays the reflection in a Smith Chart.

**MEASurement<t>:FUNction:SElect <Function>[, <Denominator>]**

This command selects the result display for S-Parameters, wave measurement (R&S ZNH-K66), ratios measurement (R&S ZNH-K66) and mixed mode measurement (R&S ZNH-K47).

The <Denominator> is only applicable for ratios measurement (R&S ZNH-K66).

**Suffix:**

&lt;t&gt; 1..n

**Parameters:**

&lt;Function&gt; S11 | S12 | S21 | S22 | A1P1 | A1P2 | B1P1 | B1P2 | A2P2 | A2P1 | B2P2 | B2P1 | SDD11 | SCD11 | SDC11 | SCC11

Selection of result display type for the numerator.

**S11 | S22**

Reflection measurement on port 1 or port 2.

**S12 | S21**

Forward or reverse transmission measurement.

**A1P1 | A1P2 | A2P1 | A2P2**

Wave quality measurement of incident wave (A1, A2) at port 1 or port 2.

**B1P1 | B1P2 | B2P1 | B2P2**

Wave quality measurement of outgoing wave (B1, B2) at port 1 or port 2.

**SDD11 | SCD11 | SDC11 | SCC11**

Mixed mode measurement for DUT with one balance port measurement.

&lt;Denominator&gt; S11 | S12 | S21 | S22 | A1P1 | A1P2 | B1P1 | B1P2 | A2P2 | A2P1 | B2P2 | B2P1 | SDD11 | SCD11 | SDC11 | SCC11

**Example:**

MEAS:FUNC:SEL A1P1

Wave measurement is selected to perform incident wave, A1 at port 1.

**Calibrating the measurement**

The following commands control calibration of cable measurements.

The suffix &lt;p&gt; selects the measurement port. It is in the range of &lt;1..2&gt;.

The suffix &lt;t&gt; selects the measurement trace. It is in the range of &lt;1..4&gt;.

**List of commands**

[SENSe:]CORRection:COAX.....	296
[SENSe:]CORRection:FREQuency:COAX.....	296
[SENSe:]CORRection:LOSS:COAX.....	296
[SENSe:]CORRection:RVELocity:COAX.....	296
CALibration:ABORt.....	297
CALibration:ATTenuation:STATus?.....	297
CALCulate<t>:CALKit:CUToff.....	297
CALCulate<t>:CALKit:USER:OFFSet<p>:LENGth.....	297
CALibration:CONTInue?.....	297
CALibration:MODE?.....	298
CALibration:STARt?.....	298
CALibration:STATus?.....	299
[SENSe:]CORRection:FREQuency:COAX.....	299

[SENSe:]CORRection:FREQuency:COAX.....	300
[SENSe:]CORRection:LOSS:COAX.....	300
[SENSe:]CORRection:RVELocity:COAX.....	300

---

### [SENSe:]CORRection:COAX <State>

This command sets whether a user defined cable model is used.

#### Parameters:

<State>                   MANual | AUTO

#### MANual

"User Model" is set to "Yes" and user-defined values are used

#### AUTO

"User Model" is set to "No" and the loaded cable model is used

#### Example:

```
SENS:CORR:COAX MAN
```

User-defined values are used for the cable model.

---

### [SENSe:]CORRection:FREQuency:COAX <CableModelFrequency>

This command sets the frequency of a user defined cable model.

#### Parameters:

<CableModelFreq>    Numeric value that defines the frequency.

Default unit: Hz

#### Example:

```
SENS:CORR:FREQ:COAX 8e6
```

```
SENS:CORR:FREQ:COAX 8 MHZ
```

---

### [SENSe:]CORRection:LOSS:COAX <CableModelLoss>

This command sets the loss of a user defined cable model.

#### Parameters:

<CableModelLoss>    Numeric value that defines the cable model loss.

Default unit: Dependable on selected length unit, unless explicitly specified. If set in meter, unit is dB/m. If set in feet, unit is dB/ft.

#### Example:

```
SENS:CORR:LOSS:COAX 4.5 dB/m
```

```
SENS:CORR:LOSS:COAX 0.3048 dB/ft
```

---

### [SENSe:]CORRection:RVELocity:COAX <CableModelVelocity>

This command sets the velocity factor of a user defined cable model.

#### Parameters:

<CableModelVelocity> Numeric value that defines the velocity factor for cable model.

Range:            0.1 to 1.0

#### Example:

```
SENS:CORR:RVEL:COAX 0.57
```



---

**CALibration:ABORt**

This command aborts calibration.

This command is an event and therefore has no query and no \*RST value.

**Example:**            CAL:ABOR  
                      Aborts calibration.

**Usage:**             Event

---

**CALibration:ATTenuation:STATus?**

This command queries the current calibration state.

This command is a query and therefore has no \*RST value.

**Example:**            CAL:ATT:STAT?  
                      Queries the calibration status of the R&S ZNH.

**Usage:**             Query only

---

**CALCulate<t>:CALKit:CUToff <PortCutoffFreq>**

This command sets the calibration cutoff frequency.

**Suffix:**  
<t>                    1..n

**Parameters:**  
<PortCutoffFreq>    Default unit: GHZ

**Example:**            CALC:CALK:CUT 4.301  
                      Sets the calibration cutoff frequency 4.301 GHz.

---

**CALCulate<t>:CALKit:USER:OFFSet<p>:LENGth <ElectricLength>**

This command sets the electrical length offset for user calibration.

**Suffix:**  
<t>                    1..n

<p>                    1..n

**Parameters:**  
<ElectricLength>    Electric length offset.  
                      Default unit: m

**Example:**            CALC:CALK:USER:OFFS1:LENG 0.1  
                      Set electrical length offset of 0.1 m at port 1.

---

**CALibration:CONTinue?**

This command resumes calibration after a calibration standard has been connected.

After the command has been sent, it returns instructions on what to do to continue the calibration process and finish it successfully.

This command is a query and therefore has no \*RST value.

**Example:**            `CAL:CONT?`  
 Resumes calibration and would return, e.g.:  
 'Connect Load to Port 1'  
 Connect the load before resuming calibration.

**Usage:**            Query only

### **CALibration:MODE?**

This command queries the general current calibration state.

This command is a query and therefore has no \*RST value.

**Example:**            `CAL:MODE?`  
 If current calibration state is not calibrated, a '0' is returned.

**Usage:**            Query only

### **CALibration:START? <CalibrationType>**

This command selects a calibration method and initiates calibration.

After the command has been sent, it returns instructions on what to do to continue the calibration process and finish it successfully.

This command is a query and therefore has no \*RST value.

**Parameters:**

<CalibrationType>    S11Cal | S12Cal | S21Cal | S22Cal | S11Norm | S12Norm |  
 S21Norm | S22Norm | F2PCal | F2PNorm | F2PHighacc |  
 T2PNorm | T2PCal | S11easy | S22easy | FULL | S11opennorm |  
 S22opennorm | F2Popennorm | S11Shortnorm | S22Shortnorm |  
 F2PShortnorm | TOSMcal | UOSMcal | TRLCal | S11Cal |  
 S22Cal | S12Norm | S21Norm | F2PCal | T2PNorm |  
 S11Opennorm | S22Opennorm | F2POpennorm |  
 S11Shortnorm | S22Shortnorm | F2PShortnorm | TOSMcal |  
 UOSMcal | TRLCal

**S11Cal**

Refl OSM calibration type on port 1.

**S22Cal**

Refl OSM calibration type on port 2.

**S12Norm**

Trans Norm calibration type from port 2 to port 1.

**S21Norm**

Trans Norm calibration type from port 1 to port 2.

**F2PCal**

Refl OSM calibration type on port 1 and port 2.

**T2PNorm**

Trans Norm calibration type from port 1 to port 2 and vice versa.

**S11Opennorm**

Refl Norm Open calibration type on port 1.

**S22Opennorm**

Refl Norm Open calibration type on port 2.

**F2POpennorm**

Refl Norm Open calibration type on port 1 and port 2.

**S11Shortnorm**

Refl Norm Short calibration type on port 1.

**S22Shortnorm**

Refl Norm Short calibration type on port 2.

**F2PShortnorm**

Refl Norm Short calibration routine on port 1 and port 2.

**TOSMcal**

A full two port calibration routine performs on both test ports.

**UOSMcal**

Same calibration routine as "TOSMcal" but with unknown Through standard.

**TRLCal**

A full two port calibration routine with Reflection standard performs on both test ports and a Through and Line standard perform on the RF ports.

**Example:**

```
CAL:STAR? S22Opennorm
```

Selects and initiates an S22Opennorm calibration and would return e.g.:

```
Calibration done
```

Calibration has been finished. No further actions required.

**Usage:**

Query only

**CALibration:STATus?**

This command queries if the R&S ZNH is fully calibrated for the current measurement.

This command is a query and therefore has no \*RST value.

**Example:**

```
CAL:STAT?
```

Queries the calibration status of the R&S ZNH.

**Usage:**

Query only

**[SENSe:]CORRection:FREQUency:COAX <CableModelFrequency>**

This command sets the frequency of a user defined cable model.

**Parameters:**

<CableModelFreq> Numeric value that defines the frequency.  
Default unit: Hz

**Example:**

```
SENS:CORR:FREQ:COAX 8e6
SENS:CORR:FREQ:COAX 8 MHZ
```

**[SENSe:]CORRection:FREQuency:COAX <CableModelFrequency>**

This command sets the frequency of a user defined cable model.

**Parameters:**

<CableModelFreq> Numeric value that defines the frequency.  
Default unit: Hz

**Example:**

```
SENS:CORR:FREQ:COAX 8e6
SENS:CORR:FREQ:COAX 8 MHZ
```

**[SENSe:]CORRection:LOSS:COAX <CableModelLoss>**

This command sets the loss of a user defined cable model.

**Parameters:**

<CableModelLoss> Numeric value that defines the cable model loss.  
Default unit: Dependable on selected length unit, unless explicitly specified. If set in meter, unit is dB/m. If set in feet, unit is dB/ft.

**Example:**

```
SENS:CORR:LOSS:COAX 4.5 dB/m
SENS:CORR:LOSS:COAX 0.3048 dB/ft
```

**[SENSe:]CORRection:RVELOCITY:COAX <CableModelVelocity>**

This command sets the velocity factor of a user defined cable model.

**Parameters:**

<CableModelVelocity> Numeric value that defines the velocity factor for cable model.  
Range: 0.1 to 1.0

**Example:**

```
SENS:CORR:RVEL:COAX 0.57
```

**Working with a DTF list**

The following commands configure the DTF peak list. The peak list is available for DTF measurements only.

The suffix <m> selects the marker. It is in the range of <1..6>.

The suffix <t> selects the measurement trace. It is in the range of <1..4>.

**List of commands**

CALCulate<t>:MARKer<m>:FUNCTion:DTF:PEAK:RESult?	301
CALCulate<t>:MARKer<m>:FUNCTion:DTF:PEAK:THReshold	301
CALCulate<t>:TRANsform:DTFault:PEAK:COUNT?	301
CALCulate<t>:TRANsform:DTFault:PEAK:DATA<1...10>?	302
CALCulate<t>:TRANsform:DTFault:PEAK[:STATe]	302
CALCulate<t>:TRANsform:DTFault:PEAK:THReshold	302

**CALCulate<t>:MARKer<m>:FUNCTion:DTF:PEAK:RESult?**

This command queries the DTF peak result on the marker position.

**Suffix:**

<t>	1..n
<m>	1..n

**Example:**

CALC:MARK1:FUNC:DTF:PEAK:RES?  
Return the DTF peak value at marker 1 position.

**Usage:** Query only

**CALCulate<t>:MARKer<m>:FUNCTion:DTF:PEAK:THReshold <ThresholdLevel>**

This command queries the DTF list.

All values that exceed the threshold are in the DTF list. You can query the list with [CALCulate<t>:TRANsform:DTFault:PEAK:DATA<1...10>?](#) on page 302.

**Suffix:**

<t>	1..n
<m>	1..n

**Parameters:**

<ThresholdLevel> Numeric value that sets the threshold level.  
The unit depends on the measurement format.

**Example:**

CALC:TRAN:DTF:PEAK:THR -20  
Sets the threshold to -20 dB.

**CALCulate<t>:TRANsform:DTFault:PEAK:COUNT?**

The following commands configure the DTF peak list. The peak list is available for DTF measurements only.

This command is a query and therefore has no \*RST value.

**Suffix:**

<t>	1..n
-----	------

**Example:**

CALC:TRAN:DTF:PEAK:COUN?Z  
Queries the number of values in the DTF list.

**Usage:** Query only

---

**CALCulate<t>:TRANSform:DTFault:PEAK:DATA<1...10>?**

This command queries the DTF list.

This command is a query and therefore has no \*RST value.

**Suffix:**

<t> 1..n

<1...10> 1...10

**Example:**

CALC:TRAN:DTF:PEAK:DATA?

Reads out the second result in the DTF peak list.

**Usage:**

Query only

---

**CALCulate<t>:TRANSform:DTFault:PEAK[:STATe] <State>**

This command turns the display of the DTF list on and off.

**Suffix:**

<t> 1..n

**Parameters:**

<State> ON | OFF

**ON**

DTF list turns on.

**OFF**

DTF list turns off.

**Example:**

CALC:TRAN:DTF:PEAK ON

Turns on the DTF peak list.

---

**CALCulate<t>:TRANSform:DTFault:PEAK:THReshold <Threshold>**

This command defines the threshold for the DTF list.

All values that exceed the threshold are in the DTF list. You can query the list with [CALCulate<t>:TRANSform:DTFault:PEAK:DATA<1...10>?](#) on page 302.

**Suffix:**

<t> 1..n

**Parameters:**

<Threshold> The unit depends on the measurement format.

**Example:**

CALC:TRAN:DTF:PEAK:THR -20

Sets the threshold to -20 dB.

### 13.6.4 Remote commands of the power meter

The chapter provides information on remote commands that configure and perform power measurements with the power sensor. These commands are available in power meter mode only.



#### Availability of remote commands for Power Sensor measurements

Note that the listed remote commands take effect only if a power sensor is connected.

- [Setting the frequency](#)..... 303
- [Setting the wavelength](#)..... 303
- [Configuring power level readout](#)..... 304
- [Defining the measurement time](#)..... 305
- [Zeroing of the power sensor](#)..... 305
- [Forward power display](#)..... 305
- [Defining the video bandwidth](#)..... 306
- [Reading measurement results](#)..... 307
- [Selecting a telecommunication standard](#)..... 308

#### 13.6.4.1 Setting the frequency

The following chapter describes commands necessary to define frequency settings.

##### List of commands

[\[SENSe:\]PMETer:FREQuency](#)..... 303

---

##### [SENSe:]PMETer:FREQuency <Frequency>

This command sets the frequency of the power sensor.

##### Parameters:

<Frequency>                      Specified in the data sheet.  
   Default unit: GHz

##### Example:

PMET:FREQ 500 MHZ  
 Sets the power sensor's frequency to 500 MHz.

#### 13.6.4.2 Setting the wavelength

The following chapter describes commands necessary to define the wavelength settings for the operation of optic power sensor.

##### List of commands

[\[SENSe:\]PMETer:WAVelength](#)..... 303

---

##### [SENSe:]PMETer:WAVelength <Wavelength>

This command sets the wavelength when the optical power sensor is connected.

See the respective optic power sensor specification for the supported wavelength.

**Parameters:**

<Wavelength>            Default unit: NM

**Example:**

PMET:WAV 1550 NM  
Set wavelength as 1550 nm.

### 13.6.4.3 Configuring power level readout

The following chapter describes commands that configure the power level readout.

The suffix <t> is irrelevant.

**List of commands**

CALCulate<t>:PMETer:RELative[MAGNitude].....	304
CALCulate<t>:PMETer:RELative[MAGNitude]:AUTO.....	304
CALCulate<t>:PMETer:RELative[MAGNitude]:OFFSet.....	304

---

**CALCulate<t>:PMETer:RELative[MAGNitude] <RefLevel>**

This command sets the reference value for relative measurements.

**Suffix:**

<t>                            1..n

**Parameters:**

<RefLevel>                Default unit: dBm

**Example:**

CALC:PMET:REL 30  
The reference value to 30 dBm.

---

**CALCulate<t>:PMETer:RELative[MAGNitude]:AUTO <ONCE>**

This command sets the current measurement result as the reference level for relative measurements.

This command is an event and therefore has no \*RST value and no query.

**Suffix:**

<t>                            1..n

**Parameters:**

<ONCE>                    ONCE

**Example:**

CALC:PMET:REL ONCE

---

**CALCulate<t>:PMETer:RELative[MAGNitude]:OFFSet <RefLvOffset>**

This command sets an offset for the reference value.

**Suffix:**

<t>                            1..n



**Parameters:**`<RefLvIOffset>` Default unit: dB**Example:**`CALC:PMET:REL -10`**13.6.4.4 Defining the measurement time**

The following chapter describes commands to define the measurement time of the power sensor.

**List of commands**

[\[SENSe:\]PMETer:MTIME](#)..... 305

**[SENSe:]PMETer:MTIME <MeasTime>**

This command sets the duration of measurements.

Available for measurements with a power sensor.

**Parameters:**`<MeasTime>` SHORT | NORMAl | LONG**Example:**`PMET:MTIME SHOR`

Sets a short measurement time for power measurements.

**13.6.4.5 Zeroing of the power sensor**

The following chapter describes commands to perform zeroing of the power sensor.

**List of commands**

[CALibration:PMETer:ZERO:AUTO](#)..... 305

**CALibration:PMETer:ZERO:AUTO <ONCE>**

This command starts to zero the power sensor.

This command is an event and therefore has no \*RST value and no query.

**Parameters:**`<ONCE>` ONCE**Example:**`CAL:PMET:ZERO:AUTO ONCE`

Starts to zero the power meter.

**13.6.4.6 Forward power display**

Note that the forward power is only available in conjunction with the R&S FSH-Z14 or R&S FSH-Z44.

**List of commands**

[SENSe:]PMETer:DETEctor[:FUNction]..... 306

**[SENSe:]PMETer:DETEctor[:FUNction] <Detector>**

This command selects the forward power display of the power sensor.

**Parameters:**

<Detector>            AVERage | PENvelope  
**AVERage**  
 Displays the average power.  
**PENvelope**  
 Displays the peak envelope power.  
 \*RST:                -

**Example:**

PMET:DET AVER  
 Selects the Average weighting mode.

**13.6.4.7 Defining the video bandwidth**

Selecting a video bandwidth is only possible when you are measuring the peak envelope power with the R&S FSH-Z44 power sensor based on a customized (= user) standard.

The suffix <t> is irrelevant.

**List of commands**

- [SENSe:]PMETer:DETEctor[:FUNction] on page 306
- CALCulate<t>:PMETer:PRESet[:STATe] on page 308
- CALCulate<t>:PMETer:PRESet:SElect on page 308

For a detailed description of the commands, see [Forward power display](#) and [Selecting a telecommunication standard](#) in power meter mode.

CALCulate<t>:PMETer:PRESet:BANDwidth:VIDeo.....306

**CALCulate<t>:PMETer:PRESet:BANDwidth:VIDeo <VideoBW>**

This command defines the video bandwidth of the R&S FSH-Z44 power sensor.

**Suffix:**

<t>                    1..n

**Parameters:**

<VideoBW>            Default unit: GHz

**Example:**

CALC:PMET:PRESet:BAND:VID 10MHZ  
 Defines a video bandwidth of 10 MHz.

### 13.6.4.8 Reading measurement results

The following chapter describes commands to configure and read measurement result from the power sensor.

#### List of commands

FETCh<z>:PMETer?.....	307
UNIT<t>:PMETer:POWer.....	307

---

#### FETCh<z>:PMETer?

This command queries the results of measurements with the power sensor.

The numeric suffix <z> at FETCh has the following effects:

**Table 13-4: Power measurement with R&S FSH-Z1, R&S FSH-Z18 and USB power sensors:**

1	Power in defined unit.
2	Not available.

**Table 13-5: Power measurement with R&S FSH-Z14 and R&S FSH-Z44:**

1	Forward power in defined unit.
2	Reflected power in defined unit.

#### Suffix:

<z> 1..n

#### Example:

FETC2:PMET?

Returns nothing for R&S FSH-Z1 / R&S FSH-Z18 and the reflected power for R&S FSH-Z14 / R&S FSH-Z44.

#### Usage:

Query only

---

#### UNIT<t>:PMETer:POWer <Unit>

This command selects the unit of the power sensor.

The numeric suffix <t> at UNIT has the following effects:

**Table 13-6: Power measurement with R&S FSH-Z1, R&S FSH-Z18 and USB power sensors:**

1	Power unit.
2	Not available.

**Table 13-7: Power measurement with R&S FSH-Z14 and R&S FSH-Z44:**

1	Forward power.
2	Reflected power.

#### Suffix:

<t> 1..n

**Parameters:**

<Unit> DBM | DB | WATT | VSWR | W | DUVM | DBUV | DBMV | DUVE | DMVE | W\_M2 | V\_M

Note on the parameter DB: when applied to UNIT1, the power is relative to the reference level, when applied to UNIT2, the return loss is displayed.

Note on the parameter VSWR: the parameter is only available if applied to UNIT2.

**Example:**

```
UNIT1:PMET:POW DBM
```

When measuring with the R&S FSH-Z1, R&S FSH-Z18 or USB power sensors: sets unit to dBm.

When measuring with the R&S FSH-Z14 or R&S FSH-Z44: sets unit of forward power to dBm.

**13.6.4.9 Selecting a telecommunication standard**

These commands apply radio communication standards to measurements with the power sensor.

The suffix <t> is irrelevant.

Note that the selection of a standard is available only for the power sensors R&S FSH-Z1, -Z14, -Z18 and Z-44.

**List of commands**

CALCulate<t>:PMETer:PRESet[:STATe].....	308
CALCulate<t>:PMETer:PRESet:SElect.....	308

**CALCulate<t>:PMETer:PRESet[:STATe] <State>**

This command turns on or off the use of a standard.

**Suffix:**

<t> 1..n

**Parameters:**

<State> ON | OFF

**Example:**

```
CALC:PMET:PRES ON
```

Activates usage of a standard.

**CALCulate<t>:PMETer:PRESet:SElect <Standard>**

This command selects the standard for power sensor measurements.

**Suffix:**

<t> 1..n

**Parameters:**

<Standard> E.g. GSM | EDGE | WCDMA | CDMAOne | CDMA2000 | DVBT | DAB | TETRA | USER

**Example:** `CALC:PMET:PRES:SEL GSM`  
Selects the GSM standard for power sensor measurements.

### 13.6.5 Remote commands of the frequency conversion power measurement

The chapter provides information on remote commands that configure and perform frequency conversion power measurements.



#### Availability of remote commands for the frequency conversion power measurement

Note that the listed remote commands take effect only if R&S ZNH-K69 is installed on the R&S ZNH.

- [Setting the frequency](#)..... 309
- [Defining the vertical axis](#)..... 312
- [Setting trace and sweep mode](#)..... 313
- [Calibrating the measurement](#)..... 314
- [Using markers and deltamarkers](#)..... 315
- [Configuring and using measurement functions](#)..... 315

#### 13.6.5.1 Setting the frequency

The following commands configure the frequency axis of the active display.

##### List of commands

- [\[SENSe:\]FREQuency:SPAN](#) on page 264

For a detailed description of the commands not described below, see [Configuring the horizontal axis](#) in CAT mode.

<a href="#">[SENSe:]PMETer:CONVersion:MODE</a> .....	310
<a href="#">[SENSe:]PMETer:CONVersion:POINts</a> .....	310
<a href="#">[SENSe:]PMETer:CONVersion:RCVFrequency:CENTer</a> .....	310
<a href="#">[SENSe:]PMETer:CONVersion:RCVFrequency:SPAN</a> .....	310
<a href="#">[SENSe:]PMETer:CONVersion:RCVFrequency:STARt</a> .....	311
<a href="#">[SENSe:]PMETer:CONVersion:RCVFrequency:STOP</a> .....	311
<a href="#">SOURce:PMETer:CONVersion:SRCFrequency:CENTer</a> .....	311
<a href="#">SOURce:PMETer:CONVersion:SRCFrequency:SPAN</a> .....	311
<a href="#">SOURce:PMETer:CONVersion:SRCFrequency:STARt</a> .....	312
<a href="#">SOURce:PMETer:CONVersion:SRCFrequency:STOP</a> .....	312

---

**[SENSe:]PMETer:CONVersion:MODE <FreqConvMode>**

This command defines the algorithm to calculate the frequency conversion measurement.

**Parameters:**

<FreqConvMode> DCUPper | DCLower | UCONversion

**DCUPper**

Calculates the upper side band of the intermediate frequency (receiving frequency), IF using the down-conversion algorithm.

**DCLower**

Calculates the lower side band of the intermediate frequency (receiving frequency), IF using the down-conversion algorithm.

**UCONversion**

Calculates the upper side band of intermediate frequency (receiving frequency), IF using the up-conversion algorithm.

**Example:**

```
PMET:CONV:MODE DCUP
```

Using down-conversion algorithm to calculate the frequency conversion measurement.

---

**[SENSe:]PMETer:CONVersion:POINTs <NrofPoints>**

This command defines the number of sweep points used in the frequency conversion measurement.

**Parameters:**

<NrofPoints> Number of measurement points.

**Example:**

```
PMET:CONV:POIN 11
```

Sets the number of sweep points as 11.

---

**[SENSe:]PMETer:CONVersion:RCVFrequency:CENTer <CenterFrequency>**

This command defines the center frequency of receiving signal.

**Parameters:**

<CenterFrequency> Numeric value in GHz.

Default unit: GHZ

**Example:**

```
PMET:CONV:RCVF:CENT 1GHz
```

Defines a center frequency of 1 GHz for the receiving signal.

---

**[SENSe:]PMETer:CONVersion:RCVFrequency:SPAN <FrequencySpan>**

This command defines the span of the receiving signal.

**Parameters:**

<FrequencySpan> Numeric value in GHz.

Default unit: GHZ

**Example:** `PMET:CONV:RCVF:SPAN 1GHz`  
 Defines a span of 1 GHz on the receiving signal.

**[SENSe:]PMETer:CONVersion:RCVFrequency:START <StartFrequency>**

This command defines the start frequency of the receiving signal.

**Parameters:**

<StartFrequency> Numeric value in GHz.  
 The range is limited to the frequency range supported by the power sensor.  
 Default unit: GHZ

**Example:** `PMET:CONV:RCVF:STAR 0.5GHz`  
 Defines a start frequency of 500 MHz for the receiving signal.

**[SENSe:]PMETer:CONVersion:RCVFrequency:STOP <StopFrequency>**

This command defines the stop frequency of the receiving signal.

**Parameters:**

<StopFrequency> Numeric value in GHz.  
 The range is limited to the frequency range supported by the power sensor.  
 Default unit: GHZ

**Example:** `PMET:CONV:RCVF:STOP 1.5GHz`  
 Defines a stop frequency of 1.5 GHz for the receiving signal.

**SOURce:PMETer:CONVersion:SRCFrequency:CENTer <CenterFrequency>**

This command defines the center frequency of source signal.

**Parameters:**

<CenterFrequency> Numeric value in GHz.  
 Default unit: GHZ

**Example:** `SOUR:PMET:CONV:SRCF:CENT 5.5GHz`  
 Defines a center frequency of 5.5 GHz for the source signal.

**SOURce:PMETer:CONVersion:SRCFrequency:SPAN <FrequencySpan>**

This command defines the span of the source signal.

**Parameters:**

<FrequencySpan> Numeric value in GHz.  
 Default unit: GHZ

**Example:** `SOUR:PMET:CONV:SRCF:SPAN 1GHz`  
 Defines a span of 1 GHz on the source signal.

**SOURce:PMETer:CONVersion:SRCFrequency:START** <StartFrequency>

This command defines the start frequency of the source signal.

**Parameters:**

<StartFrequency> Numeric value in GHz.  
The range is limited to the frequency range supported by the instrument.  
Default unit: GHZ

**Example:**

SOUR:PMET:CONV:SRCF:STAR 5GHz  
Defines a start frequency of 5 GHz for the source signal.

**SOURce:PMETer:CONVersion:SRCFrequency:STOP** <StopFrequency>

This command defines the stop frequency of the source signal.

**Parameters:**

<StopFrequency> Numeric value in GHz.  
The range is limited to the frequency range supported by the instrument.  
Default unit: GHZ

**Example:**

SOUR:PMET:CONV:SRCF:STOP 6GHz  
Defines a stop frequency of 6 GHz for the source signal.

**13.6.5.2 Defining the vertical axis**

The following commands configure the vertical (level) axis and level parameters of the active display.

The suffix <t> is irrelevant.

**List of commands**

- [DISPlay\[:WINDow\]:TRACe<t>:Y\[:SCALe\]:ADJust](#) on page 268
- [DISPlay\[:WINDow\]:TRACe<t>:Y\[:SCALe\]:RLEVel](#) on page 268
- [DISPlay\[:WINDow\]:TRACe<t>:Y\[:SCALe\]:RPOSition](#) on page 268
- [UNIT<t>:POWer](#) on page 246

For a detailed description of the commands not described below, see [Configuring the vertical axis](#) in CAT mode.

<a href="#">DISPlay[:WINDow]:TRACe&lt;t&gt;:Y:SPACing</a> .....	312
<a href="#">DISPlay[:WINDow]:TRACe&lt;t&gt;:Y[:SCALe]</a> .....	313

**DISPlay[:WINDow]:TRACe<t>:Y:SPACing** <ScalingType>

This command selects the scaling type of the vertical axis.



**Suffix:**

&lt;t&gt; 1..n

**Parameters:**

&lt;ScalingType&gt; LINear | LOGarithmic

**LINear**

Selects a linear scale (%).

**LOGarithmic**

Selects a logarithmic scale.

\*RST: LOGarithmic

**Example:**

DISP:TRAC1:Y:SPAC LIN

Selects linear scaling of the level axis for trace 1.

**DISPlay[:WINDow]:TRACe<t>:Y[:SCALE] <DisplayRange>**

This command defines the display range of the vertical axis.

Note that you have to set a logarithmic scaling before you can use this command with [DISPlay\[:WINDow\]:TRACe<t>:Y:SPACing](#) on page 312. For a linear scale, you cannot modify the display range as it is fixed.

**Suffix:**

&lt;t&gt; 1..n

**Parameters:**

&lt;DisplayRange&gt; Range: 1 dB to 150 dB

\*RST: 100 dB

Default unit: dB

**Example:**

DISP:TRAC1:Y 110dB

Sets the display range to 110 dB for trace 1.

### 13.6.5.3 Setting trace and sweep mode

The following commands set up the trace and sweep mode for measurement

The suffix <t> is irrelevant.

**List of commands**

- [CALCulate<t>:MATH:COPY:MEMory](#) on page 275
- [DISPlay\[:WINDow\]:TRACe<t>:MEMory\[:STATe\]](#) on page 275
- [DISPlay\[:WINDow\]:TRACe<t>:MODE](#) on page 276
- [INITiate:CONTinuous](#) on page 274

For a detailed description of the commands not described below, see [Working with traces](#) and [Performing measurements](#) in CAT mode.

### 13.6.5.4 Calibrating the measurement

The following commands set up the calibration for gain measurement.

#### List of commands

<a href="#">CALibration:PMETer:CONVersion:ABORt.....</a>	314
<a href="#">CALibration:PMETer:CONVersion:CONTInue?.....</a>	314
<a href="#">CALibration:PMETer:CONVersion:STARt?.....</a>	314
<a href="#">CALibration:PMETer:CONVersion:STATus?.....</a>	315

---

#### **CALibration:PMETer:CONVersion:ABORt**

This command aborts gain calibration.

This command is an event and therefore has no query and no \*RST value.

**Example:**            `CAL:PMET:CONV:ABOR`  
Aborts gain calibration.

**Usage:**            Event

---

#### **CALibration:PMETer:CONVersion:CONTInue?**

This command resumes calibration after a calibration standard has been connected.

After the command has been sent, it returns instructions on what to do to continue the calibration process and finish it successfully.

This command is a query and therefore has no \*RST value.

**Example:**            `CAL:PMET:CONV:CONT?`  
Resumes calibration and would return, e.g.:  
'Please Connect Sensor Input'  
Connect the sensor input to designated source port before  
resuming calibration.

**Usage:**            Query only

---

#### **CALibration:PMETer:CONVersion:STARt?**

This command starts the gain calibration.

After the command has been sent, it returns instructions on what to do to continue the calibration process and finish it successfully.

This command is a query and therefore has no \*RST value.

**Example:**            `CAL:PMET:CONV:STAR?`  
Initiates gain calibration and would return e.g.:  
Calibration done  
Calibration has been finished. No further actions required.

**Usage:**            Query only

**CALibration:PMETer:CONVersion:STATus?**

This command queries if the R&S ZNH is calibrated for the gain measurement.

This command is a query and therefore has no \*RST value.

**Example:**                   CAL:PMET:CONV:STAT?  
Queries the gain calibration status of the R&S ZNH.

**Usage:**                    Query only

**13.6.5.5 Using markers and deltamarkers**

The following commands control the operation of marker and delta markers functions.

The suffix <m> selects the marker. It is in the range of <1..6>.

The suffix <t> is irrelevant.

**List of commands**

- [CALCulate<t>:DELTamarker<m>\[:STATe\]](#) on page 280
- [CALCulate<t>:DELTamarker<m>:AOFF](#) on page 280
- [CALCulate<t>:DELTamarker<m>:MAXimum\[:PEAK\]](#) on page 281
- [CALCulate<t>:DELTamarker<m>:MAXimum:NEXT](#) on page 281
- [CALCulate<t>:DELTamarker<m>:MINimum\[:PEAK\]](#) on page 281
- [CALCulate<t>:DELTamarker<m>:X](#) on page 282
- [CALCulate<t>:DELTamarker<m>:X:RELative](#) on page 282
- [CALCulate<t>:DELTamarker<m>:Y?](#) on page 282
- [CALCulate<t>:MARKer<m>\[:STATe\]](#) on page 283
- [CALCulate<t>:MARKer<m>:AOFF](#) on page 283
- [CALCulate<t>:MARKer<m>:MAXimum\[:PEAK\]](#) on page 284
- [CALCulate<t>:MARKer<m>:MAXimum:NEXT](#) on page 284
- [CALCulate<t>:MARKer<m>:MINimum\[:PEAK\]](#) on page 285
- [CALCulate<t>:MARKer<m>:X](#) on page 286
- [CALCulate<t>:MARKer<m>:Y?](#) on page 288

For a detailed description of the commands not described below, see [Marker and deltamarkers](#) in the CAT mode.

**13.6.5.6 Configuring and using measurement functions****Selecting the measurement mode**

The following commands define the measurement mode.

The suffix <t> is irrelevant.

### List of commands

- [MEASurement<t>:MODE](#) on page 290  
For a detailed description of the command, see [Selecting the measurement mode](#) in CAT mode.

### Setting source power

The following commands set up the source power and source port direction for measurement

### List of commands

- [SOURce: TG: POWER](#) on page 289
- [SOURce: TG: PORT](#) on page 253

For a detailed description of the commands, see [Configuring the measurement port](#) in VNA mode.

### Performing measurement

The following commands define the selection of measurement mode and measurement format.

### List of commands

<a href="#">[SENSe:]PMETer:CONVersion:FORMat</a> .....	316
<a href="#">[SENSe:]PMETer:MEASurement</a> .....	316

---

#### [SENSe:]PMETer:CONVersion:FORMat <FrequencyConvFormat>

This command defines the frequency conversion measurement format.

#### Parameters:

<FrequencyConvFormat> ABSolute | GAIN

##### ABSolute

Sets the measurement format to absolute power measured from the sensor.

##### GAIN

Sets the measurement format to gain, measurement units in dB. The measured power from sensor is normalized with the calibration data.

#### Example:

```
PMET: CONV: FORM GAIN
```

Frequency conversion measurement is set to gain measurement.

---

#### [SENSe:]PMETer:MEASurement <Measurement>

This command defines the frequency conversion measurement mode.

#### Parameters:

<Measurement> AVERage | PFRequency | PTIME

**AVERage**

Sets to average view (available if R&S ZNH-K9 option is installed).

**PFRequency**

Sets to power vs frequency view (available if R&S ZNH-K69 option is installed).

**PTIME**

Sets to power view

## 13.6.6 Remote commands of the time domain analysis

The chapter provides information on remote commands that configure and perform time domain analysis (TDA) measurements.



### Availability of remote commands for the time domain analysis

Note that the listed remote commands take effect only if R&S ZNH-K68 is installed on the R&S ZNH.

- [Configuring the time domain analysis](#)..... 317
- [Setting the time gate](#)..... 324
- [Configuring harmonics grids](#)..... 328

### 13.6.6.1 Configuring the time domain analysis

The following chapter describes commands necessary to convert measured data from one representation to another and control the transformation into the time domain.

The suffix <t> selects the measurement trace. It is in the range of <1..4>.

#### List of commands

<a href="#">CALCulate&lt;t&gt;:TRANSform:TIME:CENTer</a> .....	318
<a href="#">CALCulate&lt;t&gt;:TRANSform:TIME:LPASs</a> .....	318
<a href="#">CALCulate&lt;t&gt;:TRANSform:TIME:LPASs:DCSParam</a> .....	318
<a href="#">CALCulate&lt;t&gt;:TRANSform:TIME:LPASs:DCSParam:CONTinuous</a> .....	319
<a href="#">CALCulate&lt;t&gt;:TRANSform:TIME:LPASs:DCSParam:EXTRapolate</a> .....	320
<a href="#">CALCulate&lt;t&gt;:TRANSform:TIME:LPFRequency</a> .....	320
<a href="#">CALCulate&lt;t&gt;:TRANSform:TIME:RESolution:EFACtor</a> .....	320
<a href="#">CALCulate&lt;t&gt;:TRANSform:TIME:SPAN</a> .....	320
<a href="#">CALCulate&lt;t&gt;:TRANSform:TIME:STARt</a> .....	321
<a href="#">CALCulate&lt;t&gt;:TRANSform:TIME:STOP</a> .....	321
<a href="#">CALCulate&lt;t&gt;:TRANSform:TIME:STATe</a> .....	321
<a href="#">CALCulate&lt;t&gt;:TRANSform:TIME:STIMulus</a> .....	322
<a href="#">CALCulate&lt;t&gt;:TRANSform:TIME:WINDow</a> .....	322
<a href="#">CALCulate&lt;t&gt;:TRANSform:TIME:XAXis</a> .....	323
<a href="#">CALCulate&lt;t&gt;:TRANSform:TIME[:TYPE]</a> .....	323

**CALCulate<t>:TRANSform:TIME:CENTer <CenterTime>**

This command sets the center time of the diagram in time domain.

**Suffix:**

<t> 1..n

**Parameters:**

<CenterTime> Center time of the diagram in time domain.  
 Range: -99.999999999999 s to +99.999999999999 s  
 Increment: 0.1 ns  
 \*RST: 1.5E-009 s  
 Default unit: s

**Example:**

```
*RST; :CALC:TRAN:TIME:STAT ON
Reset the instrument, activating a frequency sweep, and enable
the time domain transformation for the default trace.
CALC:TRAN:TIME:CENT 0; SPAN 5ns
Set the center time to 0 ns and the time span to 5 ns.
```

Note: If the x-axis is scaled in distance units ([CALCulate<t>:TRANSform:TIME: XAXisDISTance](#)), then the center value is entered in m; the range and default value changes accordingly.

**CALCulate<t>:TRANSform:TIME:LPASs <Algorithm>**

This command calculates the harmonic grid for low pass time domain transforms according to one of the three alternative algorithms.

**Suffix:**

<t> 1..n

**Parameters:**

<Algorithm> KFSTop | KDFrequency | KSDFrequency  
**KFSTop**  
 Keep stop frequency and number of points.  
**KDFrequency**  
 Keep frequency gap and number of points.  
**KSDFrequency**  
 keep stop frequency and approximate frequency gap.

**Example:**

See [CALCulate<t>:TRANSform:TIME\[:TYPE\]](#).

**CALCulate<t>:TRANSform:TIME:LPASs:DCSParm <DCValue>**

This command sets the DC value for low pass transforms. The command is enabled only if the sweep points are on a harmonic grid (to be set explicitly or using [CALCulate<t>:TRANSform:TIME:LPASs](#)).

**Suffix:**

<t> 1..n

**Parameters:**

&lt;DCValue&gt;

DC value of the measured quantity.

Range: Depending on the measured quantity (-1 to +1 for S-parameters).

\*RST: 0

**Example:**

\*RST; :CALC:TRAN:TIME:STAT ON

Reset the instrument, activating a frequency sweep with S21 as measured quantity, and enable the time domain transformation for the default trace.

CALC:TRAN:TIME LPAS; TIME:STIM STEP

Select a low pass step transformation.

CALC:TRAN:TIME:LPAS KFST

Calculate a harmonic grid, maintaining the stop frequency and the number of points.

CALC:TRAN:TIME:LPAS:DCSP 0.2

Set the DC value.

CALC:TRAN:TIME:LPAS:DCSP:EXTR; :CALC:TRAN:TIME:LPAS:DCSP?

Extrapolate the measured trace, overwrite the defined DC value, and query the new value.

CALC:TRAN:TIME:LPAS:DCSP:CONT ON

Switch over to continuous extrapolation (e.g. because you noticed a discrepancy between the manually entered DC value and the extrapolation and assume the extrapolation to be more trustworthy).

CALC:TRAN:TIME:RES:EFAC 3

Select a resolution enhancement factor of 3 in order to improve the resolution in time domain.

**CALCulate<t>:TRANSform:TIME:LPASs:DCSParm:CONTinuous <Boolean>**

This command determines whether continuous extrapolation for the DC value is enabled.

**Suffix:**

&lt;t&gt;

1..n

**Parameters:**

&lt;Boolean&gt;

ON | OFF

**ON**

Continuous extrapolation enabled.

**OFF**

Continuous extrapolation disabled.

\*RST: OFF

**Example:**See [CALCulate<t>:TRANSform:TIME:LPASs:DCSParm](#).

---

**CALCulate<t>:TRANSform:TIME:LPASs:DCSParm:EXTRapolate**

This command extrapolates the measured trace towards  $f = 0$  and overwrites the current DC value ([CALCulate<t>:TRANSform:TIME:LPASs:DCSParm](#)). The command is relevant for low pass time domain transforms.

**Suffix:**

<t> 1..n

**Example:**

See [CALCulate<t>:TRANSform:TIME:LPASs:DCSParm](#).

**Usage:**

Event

---

**CALCulate<t>:TRANSform:TIME:LPFRequency**

This command calculates the harmonic grid for low pass time domain transforms, keeping the stop frequency and the number of points.

Note: Use [CALCulate<t>:TRANSform:TIME:LPASs](#) if you wish to use one of the other algorithms for calculating the grid.

**Suffix:**

<t> 1..n

**Example:**

See [CALCulate<t>:TRANSform:TIME\[:TYPE\]](#).

**Usage:**

Event

---

**CALCulate<t>:TRANSform:TIME:RESolution:EFACtor <REfactor>**

This command sets the resolution enhancement factor for the time domain transform.

**Suffix:**

<t> 1..n

**Parameters:**

<REfactor> Resolution enhancement factor.  
 Range: 1 to 10.  
 Increment: 0.1  
 \*RST: 1 (no resolution enhancement)

**Example:**

See [CALCulate<t>:TRANSform:TIME:LPASs:DCSParm](#).

---

**CALCulate<t>:TRANSform:TIME:SPAN <Span>**

This command sets the time span of the diagram in time domain.

**Suffix:**

<t> 1..n



**Parameters:**

<Span> Time span of the diagram in time domain.  
 Range: 2E-012 s to 200 s.  
 Increment: 0.1 ns  
 \*RST: 5E-009 s  
 Default unit: s

**Example:**

See `CALCulate<t>:FILTer[:GATE]:TIME:CENTer`.

**CALCulate<t>:TRANSform:TIME:START** <StartTime>

**CALCulate<t>:TRANSform:TIME:STOP** <StopTime>

This command sets start and stop time of the diagram in time domain.

**Suffix:**

<t> 1..n

**Parameters:**

<StopTime> Start or stop time of the diagram.  
 Range: -100 s to +99.999999999998 s (start time) and  
 -99.999999999998 s to +100 s (stop time)  
 Increment: 0.1 ns  
 \*RST: -1E-009 s (start time) to +4E-009 s (stop time)  
 Default unit: s

**Example:**

\*RST; :CALC:TRAN:TIME:STAT ON

Reset the instrument, activating a frequency sweep, and enable the time domain transformation for the default trace.

`CALC:TRAN:TIME:STAR 0; STOP 10 ns`

Set the start time to 0 ns and the stop time to 10 ns.

Note: If the x-axis is scaled in distance units (`CALCulate<t>:TRANSform:TIME:XAXisDISTance`), then the start value is entered in m; the range and default value changes accordingly.

**CALCulate<t>:TRANSform:TIME:STATe** <Boolean>

This command determines whether the time gate is enabled.

**Suffix:**

<t> 1..n

**Parameters:**

<Boolean> ON | OFF  
**ON**  
 Time gate is enabled.  
**OFF**  
 Time gate is disabled.  
 \*RST: OFF

**Example:**                    \*RST; :CALC:TRAN:TIME:STAT? CALC:FILT:TIME:STAT?  
 Reset the instrument, activating a frequency sweep, and query whether the default trace is displayed in the time domain and whether the time gate is enabled. The response to both queries is 0.

### CALCulate<t>:TRANSform:TIME:STIMulus <Type>

This command selects the type of stimulus to be simulated in the low pass transformation process.

**Suffix:**

<t>                            1..n

**Parameters:**

<Type>                        IMPulse | STEP

**IMPulse**

Impulse response, in bandpass or lowpass mode.

**STEP**

Step response, only in lowpass mode (a bandpass mode setting [CALCulate<t>:TRANSform:TIME\[:TYPE\]BPASS](#) is automatically changed to lowpass).

\*RST:                        IMP

**Example:**                    See [CALCulate<t>:TRANSform:TIME\[:TYPE\]](#).

### CALCulate<t>:TRANSform:TIME:WINDow <WindowType>

This command selects the window type for filtering the data in the frequency domain prior to the time domain transformation.

**Suffix:**

<t>                            1..n

**Parameters:**

<WindowType>                RECT | HAMMING | HANNING | BOHMAN

**RECT**

No profiling (rectangle).

**HAMMING**

Low first sidelobe (Hamming).

**HANNING**

Normal profile (Hann).

**BOHMAN**

Steep falloff (Bohman).

**DCHebyshev**

Arbitrary sidelobes (Dolph-Chebychev).

**CALCulate<t>:TRANSform:TIME:XAXis <Unit>**

This command switches over between the x-axis scaling in time units or distance units.

**Suffix:**

<t> 1..n

**Parameters:**

<Unit> TIME | DISTance

**TIME**

X-axis scaled in time units.

**DISTance**

X-axis scaled in distance units (Distance = Time \* c0 \* Velocity Factor).

**Example:**

```
*RST; :CALC:TRAN:TIME:STAT ON
```

Reset the instrument, activating a frequency sweep, and enable the time domain transformation for the default trace.

```
CALC:TRAN:TIME:XAX DIST
```

Convert the x-axis scaling to distance units.

**CALCulate<t>:TRANSform:TIME[:TYPE] <TransformType>**

This command selects the time domain transformation type.

**Suffix:**

<t> 1..n

**Parameters:**

<TransformType> BPASs | LPASs

**BPASs**

Band pass impulse (only impulse response; a step response [CALCulate<t>:TRANSform:TIME:STIMulusSTEP](#) is automatically changed to impulse response).

**LPASs**

Low pass (impulse or step response, depending on [CALCulate<t>:TRANSform:TIME:STIMulus](#) setting).

```
*RST: BPASs
```

**Example:**

```
*RST; :CALC:TRAN:TIME:STAT ON
```

Reset the instrument, activating a frequency sweep, and enable the time domain transformation for the default trace.

```
CALC:TRAN:TIME LPAS; TIME:STIM STEP
```

Select a low pass step transformation.

```
CALC:TRAN:TIME:LPAS KFST
```

Calculate a harmonic grid, keeping the stop frequency and the number of points.

### 13.6.6.2 Setting the time gate

The following chapter describes commands necessary to define the properties of the time gate which is used to optimize the time domain response.

The suffix <t> selects the measurement trace. It is in the range of <1..4>.

#### List of commands

CALCulate<t>:FILTer[:GATE]:TIME:CENTer.....	324
CALCulate<t>:FILTer[:GATE]:TIME:DCHebyshev.....	324
CALCulate<t>:FILTer[:GATE]:TIME:SHAPE.....	325
CALCulate<t>:FILTer[:GATE]:TIME:SHOW.....	325
CALCulate<t>:FILTer[:GATE]:TIME:SPAN.....	326
CALCulate<t>:FILTer[:GATE]:TIME:START.....	326
CALCulate<t>:FILTer[:GATE]:TIME:STOP.....	326
CALCulate<t>:FILTer[:GATE]:TIME:STATE.....	327
CALCulate<t>:FILTer[:GATE]:TIME:WINDow.....	327
CALCulate<t>:FILTer[:GATE]:TIME[:TYPE].....	328

---

#### CALCulate<t>:FILTer[:GATE]:TIME:CENTer <CenterTime>

This command sets the center time of the time gate.

##### Suffix:

<t> 1..n

##### Parameters:

<CenterTime> Center time of the time gate.  
 Range: -99.8999999 s to +99.8999999  
 Increment: 0.1 ns  
 \*RST: 1.5E-009s  
 Default unit: s

##### Example:

```
*RST; :CALC:TRAN:TIME:STAT ON; :CALC:FILE:TIME:STAT ON
```

Reset the instrument and enable the time domain representation and time gate.

```
CALC:FILT:TIME:CENT 0; SPAN 5ns
```

Set the center time to 0 ns and the time span to 5 ns.

---

#### CALCulate<t>:FILTer[:GATE]:TIME:DCHebyshev <SidebandSupp>

This command sets the sideband suppression for the Dolph-Chebyshev time gate.

The command is only available if a Dolph-Chebyshev time gate is active

(CALCulate<t>:FILTer[:GATE]:TIME:WINDow).

##### Suffix:

<t> 1..n

**Parameters:**

<SidebandSupp> Sideband suppression.  
 Range: 10 dB to 120 dB  
 Increment: 10 dB  
 \*RST: 32 dB  
 Default unit: dB

**Example:**

```
*RST; :CALC:FILT:TIME:WIND DCH
Reset the instrument and select a Dolph-Chebyshev time gate
for filtering the data in the frequency domain.
CALC:FILT:TIME:DCH 25
Sets the sideband suppression to 25 dB.
```

**CALCulate<t>:FILTer[:GATE]:TIME:SHAPE <TimeGate>**

This command selects the time gate to be applied to the time domain transform.

Note: Use the generalized command [CALCulate<t>:FILTer\[:GATE\]:TIME:WINDow](#) if you wish to select a Dolph-Chebyshev time gate.

**Suffix:**

<t> 1..n

**Parameters:**

<TimeGate> MAXimum | WIDE | NORMal | MINimum

**MAXimum**

Maximum flatness (Bohman).

**WIDE**

Normal gate (Hann).

**NORM**

Steep edges (Hamming).

**MINimum**

Steepest edges (rectangle).

\*RST: WIDE

**Example:**

```
*RST; :CALC:FILT:TIME:SHAP?
Reset the instrument and query the type of time gate used. The
response is WIDE.
```

**CALCulate<t>:FILTer[:GATE]:TIME:SHOW <Boolean>**

This command enables or disables permanent display of the gate limits.

**Suffix:**

<t> 1..n

**Parameters:**

<Boolean> ON | OFF

**ON**

Time gate permanently displayed.

**OFF**

Time gate hidden.

**\*RST:** OFF**Example:** `CALC:FILT:TIME:SHOW ON`**Example:** Time gate limits are permanently displayed.**CALCulate<t>:FILTer[:GATE]:TIME:SPAN <Span>**

This command sets the span of the time gate.

**Suffix:**

&lt;t&gt; 1..n

**Parameters:**

<Span> Span of the time gate.  
 Range: 2E-012 s to 200 s  
 Increment: 0.1 ns  
**\*RST:** 5E-009 s  
 Default unit: s

**Example:** `CALC:FILT:TIME:SPAN 20`  
 Set span of time gate to 20 s.

**CALCulate<t>:FILTer[:GATE]:TIME:START <StartTime>****CALCulate<t>:FILTer[:GATE]:TIME:STOP <StopTime>**

These commands set the start and stop times of the time gate, respectively.

**Suffix:**

&lt;t&gt; 1..n

**Parameters:**

<StopTime> Start or stop time of the time gate.  
 Range: -100 s to +99.999999999998 s (start time) and  
 -99.999999999998 s to +100 s (stop time)  
 Increment: 0.1 ns  
**\*RST:** -1E-009 s (start time) to +4E-009 s (stop time)  
 Default unit: s

**Example:** `*RST; :CALC:TRAN:TIME:STAT ON; :CALC:FILT:TIME:STAT ON`  
 Reset the instrument and enable the time domain representation and the time gate.  
`CALC:FILT:TIME:STAR 0; STOP 10ns; SHOW ON`  
 Set the start time to 0 ns and the stop time to 10 ns and display //the time gate permanently.  
 Note: If the start frequency entered is greater than the current stop frequency, the stop frequency is set to the start frequency plus the minimum frequency span (`CALCulate<t>:FILTer[:GATE]:TIME:SPAN`).  
 If the stop frequency entered is smaller than the current start frequency, the start frequency is set to the stop frequency minus the minimum frequency span.

---

### `CALCulate<t>:FILTer[:GATE]:TIME:STATE <Boolean>`

This command determines whether the time gate is enabled.

**Suffix:**

<t> 1..n

**Parameters:**

<Boolean> ON | OFF  
**ON**  
 Time gate enabled.  
**OFF**  
 Time gate is disabled.

**Example:**

`*RST; :CALC:TRAN:TIME:STAT?`  
`CALC:FILT:TIME:STAT?`  
 Reset the instrument, activating a frequency sweep, and query whether the default trace is displayed in the time domain and whether the time gate is enabled. The response to both queries is 0.

---

### `CALCulate<t>:FILTer[:GATE]:TIME:WINDOW <TimeGate>`

This command selects the time gate to be applied to the time domain transform.

**Suffix:**

<t> 1..n

**Parameters:**

<TimeGate> RECT | HAMMING | HANNING | BOHMAN | DCHEBYSHEV  
**RECT**  
 Steepest edges (rectangle).  
**HAMMING**  
 Steep edges (Hamming).

**HANNing**

Normal gate (Hann).

**BOHMan**

Minimum flatness (Bohman).

**DCHebyshev**

Arbitrary gate shape (Dolph-Chebyshev).

\*RST: HANN

**Example:** See `CALCulate<t>:FILTer[:GATE]:TIME:DCHebyshev`.

**CALCulate<t>:FILTer[:GATE]:TIME[:TYPE] <TimeGateFilter>**

The command selects the time gate filter type, defining what occurs to the data in the specific time region.

**Suffix:**

<t> 1..n

**Parameters:**

<TimeGateFilter> BPASs | NOTCh

**BPASs**

Band pass filter: Pass all information in specified time region and reject everything else.

**NOTCh**

Notch filter: Reject all information in specified time region and pass everything else.

\*RST: BPASs

**Example:**

```
*RST; :CALC:FILT:TIME:STAT ON
```

Reset the instrument and enable the time gate.

```
CALC:FILT:TIME NOTCh
```

Select a notch filter in order to reject unwanted pulses.

**13.6.6.3 Configuring harmonics grids**

The following chapter describes commands relate to harmonic grids for time domain transformation.

**List of commands**

<code>[SENSe:]HARMonic:AUTO</code> .....	328
<code>[SENSe:]HARMonic:DLENgth:DATA</code> .....	329
<code>[SENSe:]HARMonic:RTIME:DATA</code> .....	329
<code>[SENSe:]HARMonic:RTIME:THReshold</code> .....	329

**[SENSe:]HARMonic:AUTO <arg0>**

This command sets the "Auto Harmonic" function ON or OFF.



**Parameters:**

<arg0> ON | OFF  
 \*RST: ON

**Example:**

HARM:AUTO ON  
 Activates the automatic harmonic function.

**[SENSe:]HARMonic:DLEnGth:DATA <DUTLength>**

This command sets or queries the expected maximum time delay through the DUT.

The set command automatically activates the "Auto Harmonic" function, i.e. it sets [\[SENSe:\]HARMonic:AUTO](#) to ON.

**Parameters:**

<DUTLength> Default unit: s

**Example:**

HARM:DLEN:DATA?-> 2  
 Return maximum time delay of 2 s.

**[SENSe:]HARMonic:RTIME:DATA <DUTRiseTime>**

This command sets or queries the minimum rise time to measure on the DUT.

Use [\[SENSe:\]HARMonic:RTIME:THReshold](#) to select the underlying rise time definition.

The set command automatically activates the "Auto Harmonic" function, i.e. it sets [\[SENSe:\]HARMonic:AUTO](#) to ON.

**Parameters:**

<DUTRiseTime> Default unit: s

**Example:**

HARM:RTIM:DATA?-> 1  
 Return minimum rise time of 1 s.

**[SENSe:]HARMonic:RTIME:THReshold <DUTRiseThreshold>**

This command defines how the rise time that is set using [\[SENSe:\]HARMonic:RTIME:DATA](#) shall be interpreted. Allows to select between rise time definitions 20% to 80% (default) and 10% to 90%.

The set command automatically activates the "Auto Harmonic" function, i.e. it sets [\[SENSe:\]HARMonic:AUTO](#) to ON.

**Parameters:**

<DUTRiseThreshold> T1\_9 | T2\_8  
**T1\_9**  
 Rise time definition: 10% to 90%  
**T2\_8**  
 Rise time definition: 20% to 80%  
 \*RST: T 2\_8

### 13.6.7 Remote commands of the vector voltmeter

The chapter provides information on remote commands that configure and perform vector voltmeter measurements.



#### Availability of remote commands for the vector voltmeter

Note that the listed remote commands take effect only if R&S ZNH-K45 is installed on the R&S ZNH.

- [Setting the frequency](#)..... 330
- [Setting bandwidth](#).....330
- [Setting trace and sweep mode](#).....330
- [Calibrating the measurement](#)..... 331
- [Setting source power](#)..... 331
- [Performing and triggering the measurements](#).....331

#### 13.6.7.1 Setting the frequency

The following chapter describes commands to set up frequency span for measurement.

##### List of commands

- [\[SENSe:\]FREQuency:SPAN](#) on page 264

For a detailed description of the commands, see [Configuring the horizontal axis](#) in CAT mode.

#### 13.6.7.2 Setting bandwidth

The following commands set up the bandwidth for measurement

##### List of commands

- [\[SENSe:\]BANDwidth\[:RESolution\]](#) on page 273

For a detailed description of the commands, see [Setting the bandwidth](#) in CAT mode.

#### 13.6.7.3 Setting trace and sweep mode

The following commands set up the trace and sweep mode for measurement

The suffix <t> is irrelevant.

##### List of commands

- [DISPlay\[:WINDow\]:TRACe<t>:MODE](#) on page 276
- [INITiate:CONTinuous](#) on page 274

For a detailed description of the commands, see [Working with traces](#) and [Performing measurements](#) in CAT mode.

#### 13.6.7.4 Calibrating the measurement

The following commands set up the calibration for measurement.

##### List of commands

- [CALibration:ABORt](#) on page 297
- [CALibration:ATTenuation:STATus?](#) on page 297
- [CALibration:CONTinue?](#) on page 297
- [CALibration:MODE?](#) on page 298
- [CALibration:STARt?](#) on page 298
- [CALibration:STATus?](#) on page 299

For a detailed description of the commands, see [Calibrating the measurement](#) in CAT mode.

#### 13.6.7.5 Setting source power

The following commands set up the source power and receiver attenuation for measurement

##### List of commands

- [SOURce:TG:POWer](#) on page 289

For a detailed description of the commands, see [Configuring the measurement Port](#) in CAT mode.

#### 13.6.7.6 Performing and triggering the measurements

The chapter provides information on remote commands that configure and perform vector voltmeter measurements.

The suffix <t> is irrelevant.

##### List of commands

- [TRIGger\[:SEquence\]:HOLDoff\[:TIME\]](#) on page 249
- [TRIGger\[:SEquence\]:SLOPe](#) on page 249
- [TRIGger\[:SEquence\]:SOURce](#) on page 250

For a detailed description of the commands not described below, see [Performing and triggering the measurements](#) in VNA mode.

<a href="#">CALCulate&lt;t&gt;:VVMeter:MAGNitude:REFerence?</a> .....	332
<a href="#">CALCulate&lt;t&gt;:VVMeter:MAGNitude:RESult?</a> .....	332
<a href="#">CALCulate&lt;t&gt;:VVMeter:PHASe:REFerence?</a> .....	332

CALCulate<t>:VVMeter:PHASe:RESult?.....	332
CALCulate<t>:VVMeter:REFerence[:STATe].....	333
CALCulate<t>:VVMeter:REFlection:REFerence?.....	333
CALCulate<t>:VVMeter:REFlection:RESult?.....	333
CALCulate<t>:VVMeter:VSWR:REFerence?.....	333
CALCulate<t>:VVMeter:VSWR:RESult?.....	334
MEASurement<t>:FUNction:REFlection[:STATe].....	334
MEASurement<t>:FUNction:TRANsmiSSion[:STATe].....	334

---

### CALCulate<t>:VVMeter:MAGNitude:REFerence?

This command queries the reference value for the magnitude.

To get a result, you first have to turn on the reference value with `CALCulate<t>:VVMeter:REFerence[:STATe]`.

**Suffix:**

<t> 1..n

**Example:**

`CALC:VVM:PHAS:REF?`

Queries the reference values for the magnitude.

**Usage:**

Query only

---

### CALCulate<t>:VVMeter:MAGNitude:RESult?

This command queries the magnitude of the measurement results.

**Suffix:**

<t> 1..n

**Example:**

`CALC:VVM:MAGN:RES?`

Queries the current return loss of the DUT.

**Usage:**

Query only

---

### CALCulate<t>:VVMeter:PHASe:REFerence?

This command queries the reference value for the phase of the DUT.

To get a result, you first have to turn on the reference value with `CALCulate<t>:VVMeter:REFerence[:STATe]`.

**Suffix:**

<t> 1..n

**Example:**

`CALC:VVM:PHAS:REF?`

Queries the reference value for the phase.

**Usage:**

Query only

---

### CALCulate<t>:VVMeter:PHASe:RESult?

This command queries the phase of the measurement results.

<b>Suffix:</b>	
<t>	1..n
<b>Example:</b>	CALC:VVM:PHAS:RES? Queries the current phase of the DUT.
<b>Usage:</b>	Query only

---

#### **CALCulate<t>:VVMeter:REFerence[:STATe] <State>**

This command saves the current measurement values as reference values. The reference values can be used for comparison measurements.

<b>Suffix:</b>	
<t>	1..n
<b>Parameters:</b>	
<State>	ON   OFF
<b>Example:</b>	CALC:VVM:REF ON Activates the reference values.

---

#### **CALCulate<t>:VVMeter:REFlection:REFerence?**

This command queries the reference value for the reflection measurement.

To get a result, you first have to turn on the reference value with [CALCulate<t>:VVMeter:REFerence\[:STATe\]](#).

<b>Suffix:</b>	
<t>	1..n
<b>Example:</b>	CALC:VVM:REFL:REF? Queries the reference values for the reflection.
<b>Usage:</b>	Query only

---

#### **CALCulate<t>:VVMeter:REFlection:RESult?**

This command queries the reflection measurement results.

<b>Suffix:</b>	
<t>	1..n
<b>Example:</b>	CALC:VVM:REFL:RES? Queries the reflection measurement result of the DUT.
<b>Usage:</b>	Query only

---

#### **CALCulate<t>:VVMeter:VSWR:REFerence?**

This command queries the reference value for the VSWR of the DUT.

To get a result, you first have to turn on the reference value with `CALCulate<t>:VVMeter:REFErence[:STATe]`.

**Suffix:**

<t> 1..n

**Example:**

`CALC:VVM:VSWR:REF?`  
Queries the reference values for the VSWR.

**Usage:**

Query only

**CALCulate<t>:VVMeter:VSWR:RESult?**

This command queries the VSWR of the DUT.

**Suffix:**

<t> 1..n

**Example:**

`CALC:VVM:VSWR:RES?`  
Queries the VSWR result of the DUT.

**Usage:**

Query only

**MEASurement<t>:FUNCTion:REFLECTION[:STATe] <State>**

This command sets the reflection measurement state.

**Suffix:**

<t> 1..n

**Parameters:**

<State> 1 | 0  
**1**  
Reflection measurement state is on.  
**0**  
Reflection measurement state is off.

**Example:**

`MEAS1:FUNC:REFL 1`  
Reflection measurement state is on for trace 1.

**MEASurement<t>:FUNCTion:TRANSMission[:STATe] <State>**

This command sets the transmission measurement state.

**Suffix:**

<t> 1..n

**Parameters:**

<State> 1 | 0  
**1**  
Transmission measurement state is on.  
**0**  
Transmission measurement state is off.

**Example:**                   MEAS1:FUNC:TRAN 1  
Transmission measurement state is on for trace 1.

### 13.6.8 File management

The following commands perform various tasks in the context of file management.

These commands are independent from the operating mode.

#### List of commands

MMEMory:CATalog?	335
MMEMory:CATalog:DIRectories?	335
MMEMory:CDIRectory	336
MMEMory:COPY	336
MMEMory:DATA	336
MMEMory:DELete	337
MMEMory:FILE	337
MMEMory:FILE:DATE	337
MMEMory:FILE:TIME	338
MMEMory:INIT	338
MMEMory:LOAD:STATe	338
MMEMory:MDIRectory	339
MMEMory:MOVE	339
MMEMory:RDIRectory	339
MMEMory:STORe:STATe	339
MMEMory:STORe:TRACe	340
SYSTem:SET:LOCK	341
SYSTem:SET:UNLock	341

---

#### MMEMory:CATalog?

This command queries the files of the current directory.

You can select directories with [MMEMory:CDIRectory](#) on page 336.

This command is a query and therefore has no \*RST value.

**Example:**                   MMEM:CDIR '\Public\Limit Lines'  
Opens directory 'Limit Lines'.  
MMEM:CAT?  
Returns all files in \Public\Limit Lines.

**Usage:**                    Query only

---

#### MMEMory:CATalog:DIRectories?

This command queries the directories of the current directory.

This command is a query and therefore has no \*RST value.

**Example:** MMEM:CDIR '\Public'  
 Opens directory \Public.  
 MMEM:CAT:DIR?  
 Returns all directories in the \Public directory.

**Usage:** Query only

#### MMEMory:CDIRectory <PathName>

This command changes the current directory.

**Parameters:**

<PathName> String containing the path to another directory.

**Example:** MMEM:CDIR '\Public'  
 Opens directory \Public.

#### MMEMory:COPY <SourceFile>, <Destination>

This command copies one or more files to another directory.

This command is an event and therefore has no \*RST value and no query.

**Parameters:**

<SourceFile> String containing the path and filename of the source file.

<Destination> String containing the path and name of the destination file.

**Example:** MMEM:COPY '\Public\Standards\cdmaOne.obwstd',  
 '\USB\cdmaOne.std'  
 Copies the cdmaOne standard file to a memory stick.

**Usage:** Setting only

#### MMEMory:DATA <TargetFile>[, <Block>]

This command writes block data into a file. The delimiter must be set to EOI to obtain error-free data transfer.

When you query the contents of a file, you can save them in a file on the remote control computer.

The command is useful for reading stored settings files or trace data from the instrument or for transferring them to the instrument.

**Parameters:**

<TargetFile> String containing the path and filename.

<Block> <block\_data>

Data block with the structure:

# represents hash sign

<number> represents length of the length information

<number> represents length information of the binary data  
 (number of bytes)



**Example:** `<data>` binary data with the indicated number of bytes

```
MMEM:NAME '\Public\User\Testfile.txt'
```

Creates a new file called 'Testfile.txt'.

```
MMEM:DATA
'\Public\User\Testfile.txt',#220
```

Contents of the file

The parameters mean:

- '\Public\...' selects the target file
- #2: hash sign and length of the length information (20 bytes = 2 digits)
- 20: indicates the number of subsequent binary data bytes
- Contents of the file: store 20 binary bytes (characters) to the file

```
MMEM:DATA? '\Public\User\Testfile.txt'
```

Transfers the contents of the file 'Testfile.txt' to the control computer.

---

#### MMEMory:DELeTe <File>

This command deletes a file.

##### Parameters:

<File> String containing the path and filename of the file to delete.

**Example:** `MMEM:DEL '\Public\Screen Shots\Screen0001.png'`  
Deletes the file Screen0001.png.

**Usage:** Setting only

---

#### MMEMory:FILE <FileName>[, <Block>]

This command creates a file.

##### Parameters:

<FileName> String containing the filename.

<Block> <block\_data>

**Example:** `MMEM:FILE 'TEST.TXT'`  
Creates the file TEST.TXT.

---

#### MMEMory:FILE:DATE <FileName>[, <Year>, <Month>, <Day>]

This command sets the date of a file.

##### Parameters:

<FileName> String containing the path and filename.

<Year> Range: 1980 to 2099

<Month> Range: 1 to 12

<Day> Range: 1 to 31

**Example:** `MMEM:FILE:DATE '\Public\Screen  
Shots\Screen0001.png',2006,04,01`  
Sets the date to April, 1st, 2006.  
`MMEM:FILE:DATE? '\Public\Screen  
Shots\Screen0001.png'`  
Returns the modification date of the file Screen0001.png.

### **MMEMory:FILE:TIME** <FileName>[, <Hour>, <Minutes>, <Seconds>]

This command sets the time of a file. The sequence of entry is hour, minute, second.

#### **Parameters:**

<FileName> String containing the path and filename.  
<Hour> Range: 0 to 23  
<Minutes> Range: 0 to 59  
<Seconds> Range: 0 to 59

**Example:** `MMEM:FILE:TIME '\Public\Screen  
Shots\Screen0006.png',11,04,00`  
Sets the time to 11:04:00.

### **MMEMory:INIT** [<DriveName>]

This command formats the indicated drive.

**Note:** Formatting deletes all data stored on the memory drive.

This command is an event and therefore has no \*RST value and no query.

#### **Parameters:**

<DriveName>

**Example:** `MMEM:INIT`  
Formats and deletes all data from the drive.

**Usage:** Setting only

### **MMEMory:LOAD:STATE** <1>, <SettingsFile>

This command loads the settings from a \*.set file.

#### **Parameters:**

<1>

<SettingsFile> String containing the path and filename.

**Example:** `MMEM:LOAD:STAT 1,  
'\Public\Datasets\Dataset001.set'`  
Loads the settings from the file Dataset001.

**Usage:** Setting only

---

**MMEMory:MDIRectory** <DirectoryName>

This command creates a new directory.

This command is an event and therefore has no \*RST value and no query.

**Parameters:**

<DirectoryName> String containing the path and new directory name.

**Example:**

```
MMEM:MDIR '\Public\USER'  
Creates a directory called 'User'.
```

**Usage:**

Setting only

---

**MMEMory:MOVE** <SourceFile>, <Destination>

This command renames files, if <file\_destination> contains no path. Otherwise the file is moved to the indicated path and stored under the filename specified there.

This command is an event and therefore has no \*RST value and no query.

**Parameters:**

<SourceFile> String containing the path and filename of the source file.

<Destination> String containing the path and name of the destination file.

**Example:**

```
MMEM:MOVE '\Public\Screen  
Shots\Screen0002.png', '\Public\Screen  
Shots\Screen0001.png'  
Renames Screen0002.png to Screen0001.png  
MMEM:MOVE '\Public\Screen  
Shots\Screen0001.png', '\Public\Test\Pic1.png'  
Moves file Screen0006.png to the 'Test' folder and renames the  
file Pic1.png.
```

**Usage:**

Setting only

---

**MMEMory:RDIRectory** <DirectoryName>

This command deletes the indicated directory. The directory name includes the path and may also include the drive name. The path name complies with DOS conventions.

This command is an event and therefore has no \*RST value and no query.

**Parameters:**

<DirectoryName> String containing the path of the directory to delete.

**Example:**

```
MMEM:RDIR '\Public\Screen Shots\  
Deletes the directory 'Screen Shots'.
```

**Usage:**

Setting only

---

**MMEMory:STORe:STATe** <1>, <TargetFile>

This command stores the current device settings in a \*set file.

This command is an event and therefore has no \*RST value and no query.

**Parameters:**

<1>

<TargetFile> String containing the designated path and filename of the dataset to store.

**Example:** `MMEM:STOR:STAT 1, 'DATASET001.SET'`  
Saves the current device settings in the file DATASET001.SET.

**Usage:** Setting only

**MMEMory:STORe:TRACe** <TraceName>, <FrequencyUnit>, <ParameterFormat>, <FileFormat>, <TargetFile>

This command stores the measurement trace data into the selected measurement quantity, frequency unit and touchstone format.

**Parameters:**

<TraceName> TRACe1 | TRACe2 | TRACe3 | TRACe4  
Selection of measurement trace 1 to trace 4.

<FrequencyUnit> HZ | KHZ | MHZ | GHZ  
Frequency unit of the spectrum.

<ParameterFormat> COMPLex | LINPhase | LOGPhase  
Types of measurement quantity.

**COMPLex**

Containing the real and imaginary part of the complex measured quantity.

**LINPhase**

Containing the linear vertical axis scale to display the magnitude of the measured quantity.

**LOGPhase**

Containing the dB scale of the vertical axis to display the magnitude of the measured quantity.

<FileFormat> S1P | S2P  
Touchstone file format.

<TargetFile> String containing the path and filename.

**Example:** `MMEM:STOR:TRAC TRACe1, GHz, COMP, S1P, '\Public\Dataset\test.s1p'`

Store measurement trace 1 data in GHz frequency unit containing the complex measured quantity of the S1P format to a filename 'test.s1p'.

**Usage:** Setting only

---

**SYSTem:SET:LOCK** <arg0>

This command adds write-protection to a dataset.

**Parameters:**

<arg0> String containing the path and name of the dataset.

**Example:**

```
SYST:SET:LOCK 'Dataset001.set'
Protects the file Dataset001.set from overwriting.
```

---

**SYSTem:SET:UNLock** <arg0>

This command removes write-protection from a dataset.

**Parameters:**

<arg0> String containing the path and name of the dataset.

**Example:**

```
SYST:SET:UNL 'Dataset001.set'
Removes write-protection from the file Dataset001.set.
```

### 13.6.9 Making and storing screenshots

The following commands manage screenshots.

These commands are independent from the operating mode.

**List of commands**

<a href="#">DISPlay[:WINDow]:STORe</a> .....	341
<a href="#">HCOPy:DEVice:LANGuage</a> .....	342
<a href="#">HCOPy[:IMMEDIATE]</a> .....	342
<a href="#">MMEMory:NAME</a> .....	342

---

**DISPlay[:WINDow]:STORe** <TargetFile>

This command makes a screenshot of the current display content in png or jpg format and stores it on the R&S ZNH internal memory.

You can select a filename for the screenshot in png format with [MMEMory:NAME](#) on page 342 and select the file format of the screenshot with [HCOPy:DEVice:LANGuage](#) on page 342.

This command is an event and therefore has no \*RST value and no query.

**Parameters:**

<TargetFile>

**Example:**

```
HCOP:DEV:LANG PNG
MMEM:NAME '\Public\Screen Shots\Test.png'
DISP:WIND:STOR
Makes and stores a screenshot of the current screen in a file
'Test.png'.
```

**Usage:**

Setting only

**HCOPY:DEVICE:LANGUage** <Format>

This command selects the file format for screenshots.

**Parameters:**

<Format> PNG | JPG

**Example:**

HCOP:DEV:LANG PNG

Selects the png format for screenshots.

**HCOPY[:IMMEDIATE]**

This command makes a screenshot of the current display content in png format and stores it on the R&S ZNH internal memory.

You can select a filename for the screenshot in png format with [MMEMory:NAME](#) on page 342 and select the file format of the screenshot with [HCOPY:DEVICE:LANGUage](#) on page 342.

To make a screenshot in jpg format, use [DISPlay\[:WINDow\]:STORE](#) on page 341.

This command is an event and therefore has no \*RST value and no query.

**Example:**

HCOP:DEV:LANG PNG

MMEM:NAME '\Public\Screen Shots\Test.png'

HCOP

Makes and stores a screenshot of the current screen in a file 'Test.png'.

**Usage:**

Event

**MMEMory:NAME** <FileName>

This command defines the path and filename that the R&S ZNH uses for storing screenshots (see [HCOPY\[:IMMEDIATE\]](#) on page 342). The path and filename comply with DOS conventions.

This command is an event and therefore has no \*RST value and no query.

**Parameters:**

<FileName> String containing the filename.

**Example:**

MMEM:NAME 'Public\Screenshots\Test.png'

Stores the screenshot in the corresponding directory on the R&S ZNH.

### 13.6.10 Configuring data capture

The following commands configure the data capture.

These commands are independent from the operating mode.

**List of commands**

<a href="#">SYSTem:CAPTure:COUNter</a> .....	343
<a href="#">SYSTem:CAPTure:DATaset[:STATe]</a> .....	343
<a href="#">SYSTem:CAPTure:MODE</a> .....	343
<a href="#">SYSTem:CAPTure:SCReen[:STATe]</a> .....	344

**SYSTem:CAPTure:COUNter** <CaptureCounter>

This command defines the start of the filename counter.

The counter numbers the files stored when you capture data (screenshots, datasets etc.).

**Parameters:**

<CaptureCounter> String containing the number with which to start numbering files.  
\*RST: '0000'

**Example:**

```
SYST:CAPT:COUN '0100'
```

Starts numbering files with 0100, e.g. Measurement0100.png.

**SYSTem:CAPTure:DATaset[:STATe]** <State>

This command includes or excludes datasets from the data capture.

**Parameters:**

<State> ON | OFF  
\*RST: OFF

**Example:**

```
SYST:CAPT:DAT ON
```

Includes datasets into the data capture.

**SYSTem:CAPTure:MODE** <CaptureMode>

This command selects the data types that the R&S ZNH saves when you capture the current measurement data.

**Parameters:**

<CaptureMode> SCReen | DATaset | BOTH

**SCReen**

Saves a screenshot.

**DATaset**

Saves a dataset.

**BOTH**

Saves a screenshot and a dataset.

\*RST: SCReen

**Example:**

```
SYST:CAPT:MODE BOTH
```

Captures both a screenshot and a dataset of the current measurement.

**SYSTem:CAPTure:SCReen[:STATe] <State>**

This command includes or excludes screenshots from the data capture.

**Parameters:**

<State>                    ON | OFF  
\*RST:                    ON

**Example:**

SYST:CAPT:SCR ON  
Includes screenshots into the data capture.

### 13.6.11 Configuring the instrument

The following commands configure general instrument settings. These commands are independent from the operating mode.

- [Mode selection](#)..... 344
- [Controlling the GPS receiver](#)..... 345
- [Display configuration](#)..... 347
- [Audio settings](#)..... 348
- [Setting up a network connection](#)..... 350
- [System settings](#)..... 351

#### 13.6.11.1 Mode selection

This chapter describes all commands that select the operating mode of the R&S ZNH.

**List of commands**

<a href="#">INSTrument[:SElect]</a> .....	344
<a href="#">INSTrument:NSElect</a> .....	345

**INSTrument[:SElect] <OperatingMode>**

This command selects the operating mode.

**Parameters:**

<OperatingMode>    PM | ACT | VNA | VVM

**PM**  
Power meter

**ACT**  
Cable and antenna analyzer

**VNA**  
Vector network analyzer

**VVM**  
Vector voltmeter

\*RST:                PM

**Example:**

INST PM  
Selects power meter mode.



---

**INSTrument:NSElect** <OperatingMode>

This command selects the operating mode.

**Parameters:**

<OperatingMode>	<b>2</b>	Network analyzer
	<b>5</b>	Power meter
	<b>11</b>	Cable and antenna analyzer
*RST:	1	

**Example:**           INST:NSEL 5  
Selects power meter mode.

**13.6.11.2 Controlling the GPS receiver**

This chapter describes all commands that control the GPS receiver.

**List of commands**

SYSTem:POSition:ALTitude?	345
SYSTem:POSition:GPS:CONNected?	345
SYSTem:POSition:GPS:CORRection:FREQUency?	346
SYSTem:POSition:GPS:QUALity?	346
SYSTem:POSition:GPS:SATellites?	346
SYSTem:POSition:GPS[:STATe]	346
SYSTem:POSition:LATitude?	346
SYSTem:POSition:LONGitude?	347
SYSTem:POSition:VALid?	347

---

**SYSTem:POSition:ALTitude?**

This command queries the altitude of the current position of the R&S ZNH.

**Example:**           SYST:POS:ALT?  
Return value would be, for example, 554.1.

**Usage:**             Query only

---

**SYSTem:POSition:GPS:CONNected?**

This command queries if the R&S ZNH is currently connected to the GPS receiver.

**Example:**           SYST:POS:GPS:CONN?

**Usage:**             Query only

---

**SYSTem:POSition:GPS:CORRection:FREQuency?**

This command queries the frequency correction factor.

The R&S ZNH calculates this factor from a reference signal provided by the GPS receiver. The reference signal is used to determine the deviation of the internal clock of the instrument. The deviation can be turned into a correction factor for the measured frequency.

**Example:**                `SYST:POS:GPS:CORR:FREQ?`  
Queries the frequency correction factor.

**Usage:**                Query only

---

**SYSTem:POSition:GPS:QUALity?**

This command queries the quality of the GPS signal.

**Example:**                `SYST:POS:GPS:QUAL?`

**Usage:**                Query only

---

**SYSTem:POSition:GPS:SATellites?**

This command queries the number of tracked satellites.

**Example:**                `SYST:POS:GPS:SAT?`

**Usage:**                Query only

---

**SYSTem:POSition:GPS[:STATe] <State>**

This command turns the GPS receiver on and off.

Note that the GPS receiver only works if a connection between the R&S ZNH and a GPS signal transmitter is established.

**Parameters:**  
<State>                ON | OFF  
\*RST:                OFF

**Example:**                `SYST:POS:GPS ON`  
Activates the GPS receiver.

---

**SYSTem:POSition:LATitude?**

This command queries the latitude of the current position of the R&S ZNH.

**Example:**                `SYST:POS:LAT?`  
Return value would be, for example, 48,7,40.0 for 48°, 7', 40.0" in the northern hemisphere.

**Usage:**                Query only

---

**SYSTem:POSition:LONGitude?**

This command queries the longitude of the current position of the R&S ZNH.

**Example:**           SYST:POS:LONG?  
Return value would be, for example, 11,36,46.2 for 11°, 36',  
46.2" East.

**Usage:**             Query only

---

**SYSTem:POSition:VALid?**

This command queries if the current position is valid.

**Example:**           SYST:POS:VAL?

**Usage:**             Query only

**13.6.11.3 Display configuration**

This chapter describes commands to set up the display of the R&S ZNH via remote control.

The suffix <t> is irrelevant.

**List of commands**

DISPlay<t>:BRIGhtness.....	347
DISPlay<t>:CMAp.....	347
DISPlay<t>:CMAp:DEFault.....	348
DISPlay<t>:DATE:FORMat.....	348

---

**DISPlay<t>:BRIGhtness <Brightness>**

This command sets the brightness of the display backlight.

**Suffix:**

<t>                   1..n

**Parameters:**

<Brightness>       Range:     0.01 to 1  
                      \*RST:     0.5

**Example:**           DISP:BRIG 0.80  
Sets the brightness of the display to 80%.

---

**DISPlay<t>:CMAp <ColorScheme>**

This command sets the color scheme of the display.

**Suffix:**  
 <t> 1..n

**Parameters:**  
 <ColorScheme> COLor | BW | PF

**COLor**  
 Color

**BW**  
 Black & white

**PF**  
 Printer-friendly

\*RST: COLor

**Example:** DISP:CMAP BW  
 Sets the screen colors to black and white.

#### DISPlay<t>:CMAP:DEFault

This command sets the display to the default state.

This command is an event and therefore has no query and no \*RST value.

**Suffix:**  
 <t> 1..n

**Example:** DISP:CMAP:DEF  
 Restores the original color scheme.

**Usage:** Event

#### DISPlay<t>:DATE:FORMat <DateFormat>

This command sets the display date format.

**Suffix:**  
 <t> 1..n

**Parameters:**  
 <DateFormat> DDMMyyyy | MMDDyyyy  
 \*RST: DDMMyyyy

**Example:** DISP:DATE:FORM DDMMyyyy

### 13.6.11.4 Audio settings

This chapter describes all commands to control the audio functions of the R&S ZNH.

**List of commands**

<a href="#">SYSTem:AUDio:VOLume</a> .....	349
<a href="#">SYSTem:BEEPer:POVerload[:STATe]</a> .....	349
<a href="#">SYSTem:BEEPer:VOLume</a> .....	349
<a href="#">SYSTem:BEEPer:KEY:VOLume</a> .....	349

**SYSTem:AUDio:VOLume <Volume>**

This command sets the volume of the internal speaker.

**Parameters:**

<Volume>            Range:     0 to 1  
                       \*RST:     0.3

**Example:**            SYST:AUD:VOL 0.40  
                              Sets the volume to 40%.

**SYSTem:BEEPer:POVerload[:STATe] <State>**

This command turns the beeper on and off when battery has reached its low-level state.

**Parameters:**

<State>              ON | OFF  
                       \*RST:     OFF

**Example:**            SYST:BEEP:POV ON  
                              Activates the beeper state.

**SYSTem:BEEPer:VOLume <Volume>**

This command sets the volume of the system beeper.

**Parameters:**

<Volume>            Range:     0 to 1  
                       \*RST:     0.3

**Example:**            SYST:BEEP:VOL 0.50  
                              Sets the volume of the beeper to 50%.

**SYSTem:BEEPer:KEY:VOLume <Volume>**

This command sets the volume of the keyboard click noise.

**Parameters:**

<Volume>            Range:     0 to 1  
                       \*RST:     0.3

**Example:**            SYST:BEEP:KEY:VOL 0.10  
                              Sets of keyboard clicking volume to 10%.

### 13.6.11.5 Setting up a network connection

This chapter describes all commands that are used if the R&S ZNH is part of a network.

#### List of commands

<code>SYSTem:COMMunicate:LAN:ETHernet</code> .....	350
<code>SYSTem:COMMunicate:LAN:GATeway</code> .....	350
<code>SYSTem:COMMunicate:LAN:SUBMask</code> .....	350
<code>SYSTem:COMMunicate:SOCKet:ADDRess</code> .....	350
<code>SYSTem:COMMunicate:SOCKet:DHCP[:STATe]</code> .....	351
<code>SYSTem:COMMunicate:SOCKet:PORT</code> .....	351

---

#### `SYSTem:COMMunicate:LAN:ETHernet`

This command queries the MAC address of the R&S ZNH.

This command is a query and therefore has no \*RST value.

**Example:**                    `SYST:COMM:LAN:ETH?`  
Returns the MAC address.

---

#### `SYSTem:COMMunicate:LAN:GATeway` <Gateway>

This command sets the gateway in the LAN.

**Parameters:**  
<Gateway>                    String containing the identifier of the gateway.

---

#### `SYSTem:COMMunicate:LAN:SUBMask` <Submask>

This command sets the subnet mask of the R&S ZNH

**Parameters:**  
<Submask>                    String containing the subnet mask ('x.x.x.x').  
\*RST:                        255.255.255.0

**Example:**                    `SYST:COMM:LAN:SUBM '255.255.255.0'`  
Sets the subnet mask address to 255.255.255.0.

---

#### `SYSTem:COMMunicate:SOCKet:ADDRess` <IPAddress>

This command sets the IP address of the R&S ZNH.

**Parameters:**  
<IPAddress>                    String containing the IP address ('x.x.x.x').  
\*RST:                        172.76.68.24

**Example:**                    `SYST:COMM:SOCK:ADDR '172.76.68.30'`  
Sets the IP address of the R&S ZNH to 172.76.68.30.

**SYSTem:COMMunicate:SOCKet:DHCP[:STATe]** <State>

This command turns the Dynamic Host Configuration Protocol (DHCP) on and off.

**Parameters:**

<State>                    ON | OFF  
\*RST:                    ON

**Example:**

SYST:COMM:SOCK:DHCP ON  
Activates DHCP.

**SYSTem:COMMunicate:SOCKet:PORT** <Port>

This command sets the port number for the connection.

**Parameters:**

<Port>                    Port number.  
\*RST:                    5555

**Example:**

SYST:COMM:SOCK:PORT 1000  
Sets the port number to 1000.

**13.6.11.6 System settings**

This chapter describes all commands that define or query general system settings.

**List of commands**

INPut:IMPedance:PAD.....	352
[SENSe:]ROSCillator:SOURce.....	352
SYSTem:ACCessory.....	352
SYSTem:ACCessory:AUTO.....	352
SYSTem:BNC:MODE.....	353
SYSTem:DATE.....	353
SYSTem:ERRor[:NEXT]?.....	353
SYSTem:ERRor:ALL?.....	353
SYSTem:ERRor:CODE[:NEXT]?.....	354
SYSTem:ERRor:CODE:ALL?.....	354
SYSTem:ERRor:COUNT?.....	354
SYSTem:FORMat:IDENT.....	354
SYSTem:HELP:HEADers?.....	355
SYSTem:HELP:SYNTax?.....	355
SYSTem:LANGuage.....	355
SYSTem:LANGuage:CATalog?.....	355
SYSTem:POWER:SOURce?.....	355
SYSTem:POWER:STATus?.....	356
SYSTem:PRESet.....	356
SYSTem:PRESet:FACTory.....	356
SYSTem:PRESet:MODE.....	356
SYSTem:PRESet:USER.....	356
SYSTem:REBoot.....	357

SYSTem:SET.....	357
SYSTem:SHUTdown.....	357
SYSTem:TIME.....	357
SYSTem:TZONee.....	358
SYSTem:VERSion?.....	358

---

#### INPut:IMPedance:PAD <PadType>

This command selects the matching pad connected to the R&S ZNH.

##### Parameters:

<PadType>           RAM | RAZ | HZTE

##### Example:

INPut:IMP 75;PAD RAZ

Selects 75 Ω input impedance and the R&S RAZ as the matching pad.

---

#### [SENSe:]ROSCillator:SOURce <Format>

This command selects the source of the frequency reference oscillator.

If you use an external reference signal, make sure to connect the signal to the Ext Ref BNC connector of the R&S ZNH.

##### Parameters:

<Format>           INTernal | EXTernal

##### INTernal

Internal reference.

##### EXTernal

External reference.

##### Example:

ROSC:SOUR EXT

Activates external source as reference signal.

---

#### SYSTem:ACCessory <Accessory>

This command queries the type of measurement accessory, if one is connected to the R&S ZNH (for example a power sensor).

##### Parameters:

<Accessory>       Z1 | Z2 | Z3 | Z14 | Z18 | Z44 | TS\_emf | ZN\_Z103 | NONE | UNKNown

Name of the accessory.

##### Example:

SYST:ACC?

Queries connected measurement accessories.

---

#### SYSTem:ACCessory:AUTO <State>

This command turns automatic detection of connected measurement accessories on and off.



**Parameters:**

<State> ON | OFF

**Example:**

SYST:ACC:AUTO ON

Turns on automatic accessory detection.

**SYSTem:BNC:MODE** <BNCUsage>

This command configures the BNC sockets.

**Parameters:**

<BNCUsage> REFerence | TRIGger | BIAS

**REFerence**

Input for external reference signal.

**TRIGger**

Input for external trigger.

**BIAS**

BIAS port.

\*RST: TRIGger

**Example:**

SYST:BNC:MODE BIAS

Sets the BNC socket to bias.

**SYSTem:DATE** <Year>, <Month>, <Day>

This command sets the date for the internal calendar.

**Parameters:**

<Year> Range: 1980 to 2099

<Month> Range: 1 to 12

<Day> Range: 1 to 31

**Example:**

SYST:DATE 2000,6,1

Sets the date to 1/6/2000.

**SYSTem:ERRor[:NEXT]?**

This command queries the oldest entry in the error queue and deletes it.

This command is a query and therefore has no \*RST value.

**Example:**

STAT:ERR?

**Usage:**

Query only

**SYSTem:ERRor:ALL?**

This command queries the complete error queue.

This command is a query and therefore no \*RST value.

**Example:**                `SYST:ERR:ALL?`

**Usage:**                Query only

#### **SYSTem:ERRor:CODE[:NEXT]?**

This command queries the code of the next error in the error queue.

This command is a query and therefore has no \*RST value.

**Example:**                `STAT:ERR:CODE?`

**Usage:**                Query only

#### **SYSTem:ERRor:CODE:ALL?**

This command queries the complete error queue.

This command is a query and therefore no \*RST value.

**Example:**                `SYST:ERR:CODE:ALL?`

**Usage:**                Query only

#### **SYSTem:ERRor:COUNt?**

This command queries the number of errors currently in the error queue.

This command is a query and therefore no \*RST value.

**Example:**                `SYST:ERR:COUN?`

**Usage:**                Query only

#### **SYSTem:FORMat:IDENt <Format>**

This command sets the response format to the \*IDN? query. This function is intended for re-use of existing control programs together with the R&S ZNH.

**Parameters:**

<Format>                LEGacy | NEW

**LEGacy**

Format that is compatible to the older R&S ZNH version.

**NEW**

Format that is compatible to the newer R&S ZNH version.

**Example:**

`SYST:FORM:IDEN LEG`

`*IDN?`

IDN would return the older R&S ZNH version.

`SYST:FORM:IDEN NEW`

`*IDN?`

IDN would return the newer R&S ZNH version.

---

**SYSTem:HELP:HEADers?**

This command returns a list of all available remote control commands.

This command is a query and therefore no \*RST value.

**Example:**               SYST:HELP:HEAD?  
Returns the syntax of all available commands.

**Usage:**                Query only

---

**SYSTem:HELP:SYNTax? <arg0>**

This command returns the full syntax of the specified command.

This command is a query and therefore no \*RST value.

**Parameters:**  
<arg0>                String containing the command you want to query.

**Example:**               SYST:HELP:SYNT? 'SYST:ERR?'  
Returns the full syntax. In this case: 'SYSTem:ERRor[:NEXT]'.

**Usage:**                Query only

---

**SYSTem:LANGUage <Language>**

This command sets the language of the user interface. You can query a list of available languages with [SYSTem:LANGUage:CATalog?](#) on page 355.

**Parameters:**  
<Language>           String containing the language.

**Example:**               SYST:LANG 'english'  
Sets the system language to English.

---

**SYSTem:LANGUage:CATalog?**

This command lists all languages available for the user interface.

This command is a query and therefore no \*RST value.

**Example:**               SYST:LANG:CAT?

**Usage:**                Query only

---

**SYSTem:POWer:SOURce?**

This command queries the current R&S ZNH power source.

This command is a query and therefore has no \*RST value.

**Example:**               SYST:POW:SOUR?

**Usage:**                Query only

---

**SYSTem:POWer:STATus?**

This command queries the remaining power of the battery.

This command is a query and therefore has no \*RST value.

**Example:**               SYST:POW:STAT?

**Usage:**                Query only

---

**SYSTem:PRESet**

Resets the R&S ZNH to its default state or a state defined by the user, depending on SYSTem:PRESet:MODE.

This command is an event and therefore has no \*RST value and no query.

**Example:**               SYST:PRES

**Usage:**                Event

---

**SYSTem:PRESet:FACTory**

This command initiates an instrument reset back to factory settings.

This command is an event and therefore has no query and no \*RST value.

**Example:**               SYST:PRES:FACT  
Resets the R&S ZNH to its factory settings.

**Usage:**                Event

---

**SYSTem:PRESet:MODE <Mode>**

This command selects the preset mode.

**Parameters:**

<Mode>                DEFault | USER

**DEFault**

Default preset state.

**USER**

User defined preset state.

**Example:**               SYST:PRES:MODE USER  
Selects a user defined preset.

---

**SYSTem:PRESet:USER <PathName>**

This command selects a file containing a user defined preset state.

**Parameters:**

<PathName>            Filename of the user defined preset state.

---

**SYSTem:REBoot**

This command initiates a reboot of the R&S ZNH.

This command is an event and therefore has no \*RST value and no query.

**Example:**               SYST:REB  
                          Restarts the R&S ZNH.

**Usage:**                Event

---

**SYSTem:SET [<arg0>]**

This query `SYSTem:SET?` causes the data of the current instrument setting to be transmitted to the control computer in binary format (SAVE function). The data can be read back into the instrument (RECALL function) by means of command `SYSTem:SET <block>`.

Whilst the data records are stored on the instrument hard disk with SAVE/RECALL (`MMEMory:STORe`, `MMEMory:LOAD`), it is possible to store the data in an external computer by means of `SYSTem:SET`.

The receive terminator has to be set to EOI to ensure reliable transfer of data (setting `SYST:COMM:GPIB:RTER EOI`).

**Parameters:**  
<arg0>                <block\_data>

**Example:**               SYST:SET

---

**SYSTem:SHUTdown**

This command turns the R&S ZNH off.

This command is an event and therefore has no \*RST value and no query.

**Example:**               SYST:SHUT  
                          Turns the R&S ZNH off.

**Usage:**                Event

---

**SYSTem:TIME <Hour>, <Minutes>, <Seconds>**

This command sets the internal clock.

**Parameters:**  
<Hour>                Range:     0 to 23  
<Minutes>            Range:     0 to 59  
<Seconds>            Range:     0 to 59

**Example:**               SYST:TIME 12,30,30

---

**SYSTem:TZONee** <Hour>, <Minutes>

This command defines a shift of the system time to select another time zone.

**Parameters:**

<Hour>	Range:	0 to 23
<Minutes>	Range:	0 to 59
	*RST:	0,0

**Example:**

```
SYST:TZON 01,00
```

Shifts the time an hour ahead.

**SYSTem:VERSion?**

This command queries the SCPI version the remote control is based on.

This command is a query and therefore has no \*RST value.

**Example:**               SYST:VERS?

**Usage:**                Query only

### 13.6.12 Status reporting system

The status reporting system stores all information on the present operating state of the instrument, and on errors which have occurred. This information is stored in the status registers and in the error queue. The status registers and the error queue can be queried via Ethernet.

The information is of a hierarchical structure. The register status byte (STB) defined in IEEE 488.2 and its associated mask register service request enable (SRE) form the uppermost level. The STB receives its information from the standard event status register (ESR) which is also defined in IEEE 488.2 with the associated mask register standard event status enable (ESE) and registers *STATus:OPERation* and *STATus:QUEStionable* which are defined by SCPI and contain detailed information on the instrument.

The output buffer contains the messages the instrument returns to the controller. It is not part of the status reporting system but determines the value of the MAV bit in the STB.

- [Structure of a SCPI status register](#).....359
- [Overview of the status register](#).....360
- [Status byte \(STB\) & service request enable register \(SRE\)](#)..... 361
- [Event status register \(ESR\) and event status enable register \(ESE\)](#).....362
- [Application of the status reporting systems](#).....365
- [Reset values of the status reporting system](#)..... 367
- [Remote commands of the status reporting system](#).....367

### 13.6.12.1 Structure of a SCPI status register

Each standard SCPI register consists of 5 parts which each have a width of 16 bits and have different functions. The individual bits are independent of each other, i.e. each hardware status is assigned a bit number that applies to all five parts. For example, bit 0 of the STATUS:OPERation register is assigned to the calibration status of the R&S ZNH. Bit 15 (the most significant bit) is set to zero for all parts. Thus the contents of the register parts can be processed by the controller as positive integer.

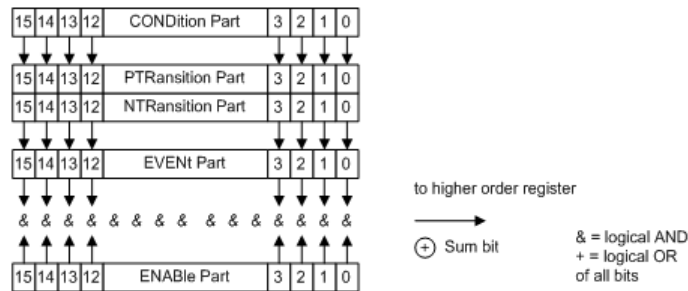

Figure 13-6: The status-register model

#### CONDition part

The CONDition part is directly written into by the hardware or the sum bit of the next lower register. Its contents reflects the current instrument status. This register part can only be read, but not written into or cleared. Its contents is not affected by reading.

#### PTRansition part

The Positive-TRansition part acts as an edge detector. When a bit of the CONDition part is changed from 0 to 1, the associated PTR bit decides whether the EVENT bit is set to 1.

PTR bit =1: the EVENT bit is set.

PTR bit =0: the EVENT bit is not set.

This part can be written into and read at will. Its contents is not affected by reading.

#### NTRansition part

The Negative-TRansition part also acts as an edge detector. When a bit of the CONDition part is changed from 1 to 0, the associated NTR bit decides whether the EVENT bit is set to 1.

NTR-Bit = 1: the EVENT bit is set.

NTR-Bit = 0: the EVENT bit is not set.

This part can be written into and read at will. Its contents is not affected by reading.

With these two edge register parts, you can define which state transition of the condition part (none, 0 to 1, 1 to 0 or both) is stored in the EVENT part.

### EVENT part

The EVENT part indicates whether an event has occurred since the last reading, it is the "memory" of the condition part. It only indicates events passed on by the edge filters. It is permanently updated by the instrument. This part can only be read by you. Reading the register clears it. This part is often equated with the entire register.

### ENABLE part

The ENABLE part determines whether the associated EVENT bit contributes to the sum bit (see below). Each bit of the EVENT part is ANDed with the associated ENABLE bit (symbol '&'). The results of all logical operations of this part are passed on to the sum bit via an OR function (symbol '+').

ENABLE-Bit = 0: the associated EVENT bit does not contribute to the sum bit

ENABLE-Bit = 1: if the associated EVENT bit is "1", the sum bit is set to "1" as well.

This part can be written into and read by you at will. Its contents is not affected by reading.

### Sum bit

As indicated above, the sum bit is obtained from the EVENT and ENABLE part for each register. The result is then entered into a bit of the CONDition part of the higher-order register.

The instrument automatically generates the sum bit for each register. Thus an event, e.g. a PLL that has not locked, can lead to a service request throughout all levels of the hierarchy.



The service request enable register SRE defined in IEEE 488.2 can be taken as ENABLE part of the STB if the STB is structured according to SCPI. By analogy, the ESE can be taken as the ENABLE part of the ESR.

#### 13.6.12.2 Overview of the status register

The following figure shows the status registers used by the R&S ZNH.



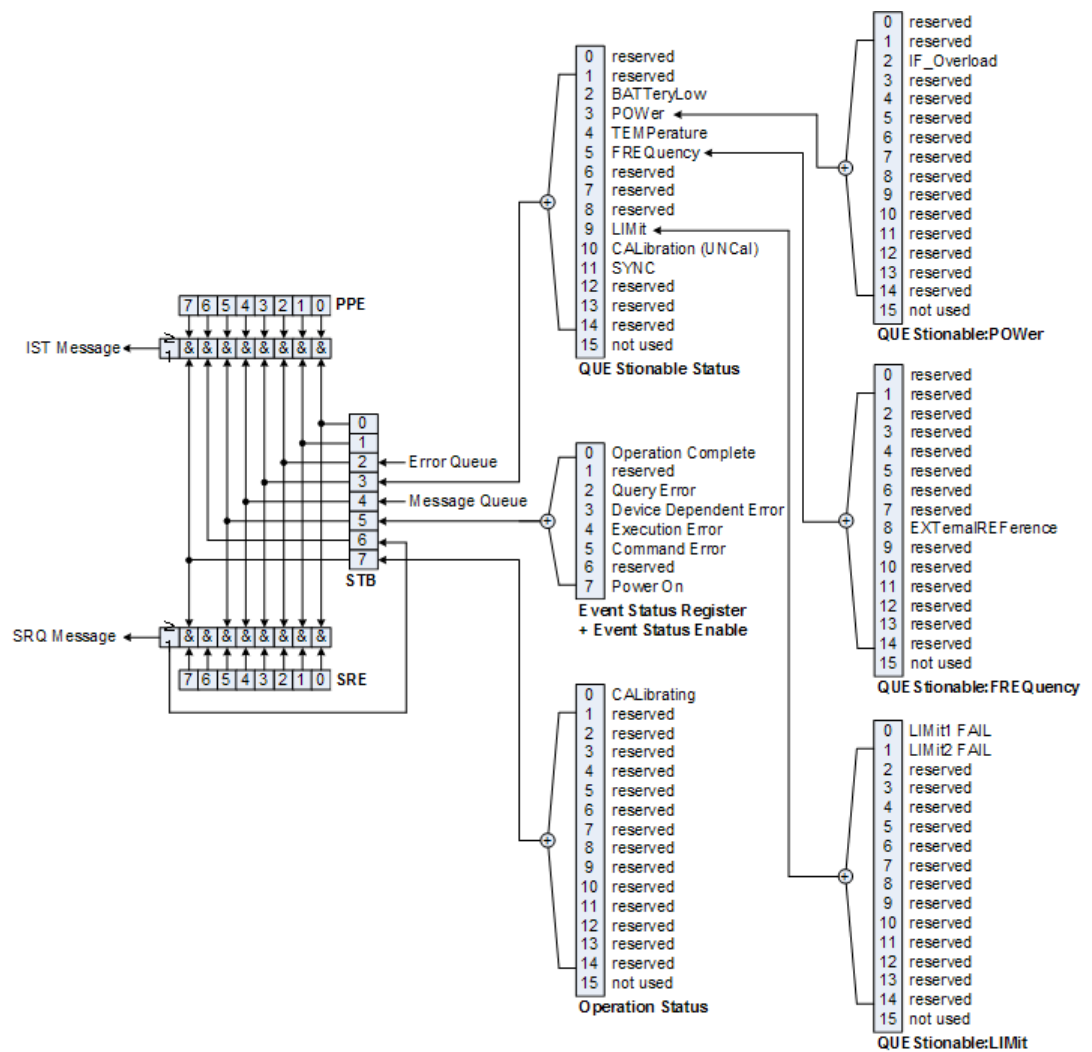

Figure 13-7: Overview of the status registers

### 13.6.12.3 Status byte (STB) & service request enable register (SRE)

The STB is already defined in IEEE 488.2. It provides a rough overview of the instrument status by collecting the pieces of information of the lower registers. It can thus be compared with the CONDition part of an SCPI register and assumes the highest level within the SCPI hierarchy. A special feature is that bit six acts as the sum bit of the remaining bits of the status byte.

The STATUS BYTE is read using the command `*STB?` or a serial poll.

The STB is linked to the SRE. The latter corresponds to the ENABLE part of the SCPI registers in its function. Each bit of the STB is assigned a bit in the SRE. Bit 6 of the SRE is ignored. If a bit is set in the SRE and the associated bit in the STB changes from 0 to 1, a service request (SRQ) is generated, which triggers an interrupt in the controller if this is appropriately configured and can be further processed there. The SRE can be set using the command `"*SRE"` and read using the command `*SRE?`

**Table 13-8: Meaning of the bits used in the status byte**

Bit no.	Meaning
0 to 1	Not used
2	<p>Error Queue not empty</p> <p>The bit is set when an entry is made in the error queue.</p> <p>If this bit is enabled by the SRE, each entry of the error queue generates a service request. Thus an error can be recognized and specified in greater detail by polling the error queue. The poll provides an informative error message. This procedure is to be recommended since it considerably reduces the problems involved with remote control.</p>
3	<p>QUESTionable status sum bit</p> <p>The bit is set if an EVENT bit is set in the QUESTionable: status register and the associated ENABle bit are set to 1.</p> <p>A set bit indicates a questionable instrument status, which can be specified in greater detail by polling the QUESTionable status register.</p>
4	<p>MAV bit (message available)</p> <p>The bit is set if a message is available in the output buffer which can be read.</p> <p>This bit can be used to enable data to be automatically read from the instrument to the controller.</p>
5	<p>ESB bit</p> <p>Sum bit of the event status register. It is set if one of the bits in the event status register is set and enabled in the event status enable register.</p> <p>Setting of this bit indicates a serious error which can be specified in greater detail by polling the event status register.</p>
6	<p>MSS bit (master status summary bit)</p> <p>The bit is set if the instrument triggers a service request. This is the case if one of the other bits of this register is set together with its mask bit in the service request enable register SRE.</p>
7	<p>OPERation status register sum bit</p> <p>The bit is set if an EVENT bit is set in the OPERation status register and the associated ENABle bit is set to 1.</p> <p>A set bit indicates that the instrument is just performing an action. The type of action can be determined by polling the OPERation status register.</p>

#### 13.6.12.4 Event status register (ESR) and event status enable register (ESE)

The ESR is defined in IEEE 488.2. It can be compared with the EVENT part of an SCPI register. The event status register can be read out using command `*ESR?`.

The ESE is the associated ENABle part. It can be set using the command `*ESE` and read using the command `*ESE?`.

**Table 13-9: Meaning of the bits in the event status register**

Bit No.	Meaning
0	<p>Operation Complete</p> <p>This bit is set on receipt of the command <code>*OPC</code> exactly when all previous commands have been executed.</p>
1	Not used

Bit No.	Meaning
2	<p>Query Error</p> <p>This bit is set if either the controller wants to read data from the instrument without having sent a query, or if it does not fetch requested data and sends new instructions to the instrument instead. The cause is often a query which is faulty and hence cannot be executed.</p>
3	<p>Device-dependent Error</p> <p>This bit is set if a device-dependent error occurs. An error message with a number between -300 and -399 or a positive error number, which denotes the error in greater detail, is entered into the error queue.</p>
4	<p>Execution Error</p> <p>This bit is set if a received command is syntactically correct but cannot be performed for other reasons. An error message with a number between -200 and -300, which denotes the error in greater detail, is entered into the error queue.</p>
5	<p>Command Error</p> <p>This bit is set if a command is received, which is undefined or syntactically incorrect. An error message with a number between -100 and -200, which denotes the error in greater detail, is entered into the error queue.</p>
6	Not used
7	<p>Power On (supply voltage on)</p> <p>This bit is set on switching on the instrument.</p>

### STATus:OPERation register

In the CONDition part, this register contains information on which actions the instrument is being executing or, in the EVENT part, information on which actions the instrument has executed since the last reading. It can be read using the commands `STATus:OPERation:CONDition?` or `STATus:OPERation[:EVENT]?`.

*Table 13-10: Meaning of the bits in the STATus:OPERation register*

Bit no.	Meaning
0	<p>CALibrating</p> <p>This bit is set as long as the instrument is performing a calibration.</p>
1 to 14	Not used
15	This bit is always 0

### STATus:QUESTionable register

This register contains information about indefinite states which may occur if the unit is operated without meeting the specifications. It can be read using the commands `STATus:QUESTionable:CONDition?` and `STATus:QUESTionable[:EVENT]?`.

**Table 13-11: Meaning of bits in STATUS:QUESTIONable register**

Bit no.	Meaning
0 to 1	These bits are not used
2	BATTERY LOW If the instrument is running without any external power supply and the charging level of the internal battery is approximately lower than 5%, this bit is set to indicate that the system is shut down automatically in approximately 5 minutes.
3	Not used
4	TEMPerature This bit is set if a questionable temperature occurs.
5 to 8	Not used
9	LIMit (device-specific) This bit is set if a limit value is violated
10	CALibration The bit is set if a measurement is performed unaligned (label UNCAL)
11 to 14	Not used
15	This bit is always 0.

**STATUS:QUESTIONable:FREQUENCY register**

This register contains information about the reference frequency. It can be read using the commands `STATUS:QUESTIONable:LIMit:FREQUENCY?` and `STATUS:QUESTIONable:FREQUENCY[:EVENT]?`.

**Table 13-12: Meaning of bits in STATUS:QUESTIONable:FREQUENCY register**

Bit no.	Meaning
0 to 7	Not used
8	EXTernal REFerence This bit is set if an external reference is used.
9 to 14	Not used
15	This bit is always 0.

**STATUS:QUESTIONable:LIMit register**

This register contains information about the observance of limit lines. It can be read using the commands `STATUS:QUESTIONable:LIMit:CONDition?` and `STATUS:QUESTIONable:LIMit[:EVENT]?`.

**Table 13-13: Meaning of bits in STATUS:QUESTIONable:LIMit register**

Bit no.	Meaning
0	LIMit 1 FAIL This bit is set if limit line 1 is violated.
1	LIMit 2 FAIL This bit is set if limit line 2 is violated.
2 to 14	Not used
15	This bit is always 0.

**STATUS:QUESTIONable:POWER register**

This register contains information about possible overload states. It can be read using the commands `STATUS:QUESTIONable:POWER:CONDition?` and `STATUS:QUESTIONable:POWER[:EVENT]?`.

**Table 13-14: Meaning of bits in STATUS:QUESTIONable:POWER register**

Bit no.	Meaning
0 to 1	Not used
2	IF_Overload This bit is set if the IF path is overloaded. 'IFOVL' is displayed.
3 to 14	Not used
15	This bit is always 0.

**STATUS:QUESTIONable:SYNC register**

This register contains information about sync and bursts not found, and about premeasurement results exceeding or falling short of expected values.

It can be read using the commands `STATUS:QUESTIONable:SYNC:CONDition?` and `STATUS:QUESTIONable:SYNC[:EVENT]?`.

**13.6.12.5 Application of the status reporting systems**

In order to be able to effectively use the status reporting system, the information contained there must be transmitted to the controller and further processed there. There are several methods which are represented in the following.

**Service request**

Under certain circumstances, the instrument can send a service request (SRQ) to the controller. Usually this service request initiates an interrupt at the controller, to which the control program can react appropriately.

As evident from [Figure 13-7](#), an SRQ is always initiated if one or several of bits 2, 3, 4, 5 or 7 of the status byte are set and enabled in the SRE. Each of these bits combines the information of a further register, the error queue or the output buffer. The ENABLE parts of the status registers can be set so that arbitrary bits in an arbitrary status regis-

ter initiate an SRQ. In order to make use of the possibilities of the service request effectively, all bits should be set to "1" in enable registers SRE and ESE.

**Example:**

Use of the command \*OPC to generate an SRQ at the end of a sweep.

- `CALL InstrWrite(analyzer, "*ESE 1")`  
'Set bit 0 in the ESE (Operation Complete)
- `CALL InstrWrite(analyzer, "*SRE 32")`  
'Set bit 5 in the SRE (ESB)?

After its settings have been completed, the instrument generates an SRQ.

The SRQ is the only possibility for the instrument to become active on its own. Each controller program should set the instrument in a way that a service request is initiated in the case of malfunction. The program should react appropriately to the service request.

**Serial poll**

In a serial poll, just as with command \*STB, the status byte of an instrument is queried. However, the query is realized via interface messages and is thus clearly faster. The serial-poll method has already been defined in IEEE 488.1 and used to be the only standard possibility for different instruments to poll the status byte. The method also works with instruments which do not adhere to SCPI or IEEE 488.2.

The VISUAL BASIC command for executing a serial poll is IBRSP(). Serial poll is mainly used to obtain a fast overview of the state of several instruments connected to the controller.

**Query by means of commands**

Each part of any status register can be read by means of queries. The individual commands are listed in the description of the STATUS Subsystem. The returned value is always a number that represents the bit pattern of the queried register. This number is evaluated by the controller program.

Queries are usually used after an SRQ in order to obtain more detailed information on the cause of the SRQ.

**Error queue query**

Each error state in the instrument leads to an entry in the error queue. The entries of the error queue are detailed plain-text error messages that can be displayed via manual operation using the setup menu or queried via remote control using the command `SYSTEM:ERROR?`. Each call of `SYSTEM:ERROR?` provides one entry from the error queue. If no error messages are stored there any more, the instrument responds with 0, "No error".

The error queue should be queried after every SRQ in the controller program as the entries describe the cause of an error more precisely than the status registers. Especially in the test phase of a controller program the error queue should be queried regu-

larly since faulty commands from the controller to the instrument are recorded there as well.

### 13.6.12.6 Reset values of the status reporting system

Table 13-15 contains the different commands and events causing the status reporting system to be reset. None of the commands, except \*RST and SYSTem:PRESet, influences the functional instrument settings. In particular, DCL does not change the instrument settings.

**Table 13-15: Resetting the status reporting system**

Event	Switching on supply voltage	DCL, SDC				
	Power-On-Status-Clear		(Device Clear, Selected Device Clear)	*RST or SYSTem:PRESet	STAtus:PRESet	*CLS
Effect	0	1				
Clear STB, ESR	-	yes	-	-	-	yes
Clear SRE, ESE	-	yes	-	-	-	-
Clear PPE	-	yes	-	-	-	-
Clear EVENT parts of the registers	-	yes	-	-	-	yes
Clear ENABLE parts of all OPERATION and QUESTIONABLE registers; Fill ENABLE parts of all other registers with "1".	-	yes	-	-	yes	-
Fill PTRansition parts with "1"; Clear NTRansition parts	-	yes	-	-	yes	-
Clear error queue	yes	yes	-	-	-	yes
Clear output buffer	yes	yes	yes	1)	1)	1)
Clear command processing and input buffer	yes	yes	yes	-	-	-

1) Every command being the first in a program message, i.e., immediately following a <PROGRAM MESSAGE TERMINATOR> clears the output buffer.

### 13.6.12.7 Remote commands of the status reporting system

The following commands control the status-reporting system \*RST does not influence the status registers.

The OPERation status register contains information about the calibration status of the instrument.

The QUESTionable status register contains information about the status of the reference and local oscillator, possible overloads of the instrument and the status of limit checks and limit margins.

The commands are independent from the operating mode.

### List of commands

STATus:PRESet.....	368
STATus:QUEue[:NEXT]?.....	369
STATus:OPERation[:EVENT]?.....	369
STATus:OPERation:CONDition?.....	369
STATus:OPERation:ENABle.....	369
STATus:OPERation:NTRansition.....	369
STATus:OPERation:PTRansition.....	370
STATus:QUESTionable[:EVENT]?.....	370
STATus:QUESTionable:FREQuency[:EVENT]?.....	370
STATus:QUESTionable:LIMit[:EVENT]?.....	370
STATus:QUESTionable:POWer[:EVENT]?.....	370
STATus:QUESTionable:CONDition?.....	370
STATus:QUESTionable:FREQuency:CONDition?.....	371
STATus:QUESTionable:LIMit:CONDition?.....	371
STATus:QUESTionable:POWer:CONDition?.....	371
STATus:QUESTionable:ENABle.....	371
STATus:QUESTionable:FREQuency:ENABle.....	371
STATus:QUESTionable:LIMit:ENABle.....	371
STATus:QUESTionable:POWer:ENABle.....	372
STATus:QUESTionable:NTRansition.....	372
STATus:QUESTionable:FREQuency:NTRansition.....	372
STATus:QUESTionable:LIMit:NTRansition.....	372
STATus:QUESTionable:POWer:NTRansition.....	373
STATus:QUESTionable:PTRansition.....	373
STATus:QUESTionable:FREQuency:PTRansition.....	373
STATus:QUESTionable:LIMit:PTRansition.....	373
STATus:QUESTionable:POWer:PTRansition.....	374

---

### STATus:PRESet

This command resets the edge detectors and ENABle parts of all registers to a defined value. All PTRansition parts are set to FFFFh, i.e. all transitions from 0 to 1 are detected. All NTRansition parts are set to 0, i.e. a transition from 1 to 0 in a CONDition bit is not detected. The ENABle part of the STATus:OPERation and STATus:QUESTionable registers are set to 0, i.e. all events in these registers are not passed on.

**Example:** STAT:PRESet

**Usage:** Event



---

**STATus:QUEue[:NEXT]?**

This command returns the earliest entry to the error queue and deletes it.

Positive error numbers indicate device-specific errors, negative error numbers are error messages defined by SCPI. If the error queue is empty, the error number 0, "no error", is returned. This command is identical with the command SYSTem:ERRor.

**Example:** STAT:QUE?

**Usage:** Query only

---

**STATus:OPERation[:EVENT]?**

This command reads out the EVENT section of the OPERation register.

The command at the same time deletes the contents of the EVENT section.

**Usage:** Query only

---

**STATus:OPERation:CONDition?**

This command reads out the CONDition section of the OPERation register.

The command does not delete the contents of the EVENT section.

**Usage:** Query only

---

**STATus:OPERation:ENABLE <DecimalValue>**

This command controls the ENABLE part of the OPERation register.

The ENABLE part allows true conditions in the EVENT part of the status register to be reported in the summary bit. If a bit is 1 in the enable register and its associated event bit transitions to true, a positive transition occurs in the summary bit reported to the next higher level.

**Parameters:**

<DecimalValue> Range: 0 to 65535

---

**STATus:OPERation:NTRansition <DecimalValue>**

This command controls the Negative TRansition part of the OPERation register.

Setting a bit causes a 1 to 0 transition in the corresponding bit of the associated register. The transition also writes a 1 into the associated bit of the corresponding EVENT register.

**Parameters:**

<DecimalValue> Range: 0 to 65535

---

**STATus:OPERation:PTRansition** <DecimalValue>

This command controls the Positive TRansition part of the OPERation register.

Setting a bit causes a 0 to 1 transition in the corresponding bit of the associated register. The transition also writes a 1 into the associated bit of the corresponding EVENT register.

**Parameters:**

<DecimalValue>      Range:      0 to 65535

---

**STATus:QUEStionable[:EVENT]?**

This command reads out the EVENT section of the QUEStionable register.

The command at the same time deletes the contents of the EVENT section.

**Usage:**              Query only

---

**STATus:QUEStionable:FREQuency[:EVENT]?**

This command reads out the EVENT section of the QUEStionable register.

The command at the same time deletes the contents of the EVENT section.

**Usage:**              Query only

---

**STATus:QUEStionable:LIMit[:EVENT]?**

This command reads out the EVENT section of the QUEStionable register.

The command at the same time deletes the contents of the EVENT section.

**Usage:**              Query only

---

**STATus:QUEStionable:POWer[:EVENT]?**

This command reads out the EVENT section of the QUEStionable register.

The command at the same time deletes the contents of the EVENT section.

**Usage:**              Query only

---

**STATus:QUEStionable:CONDition?**

This command reads out the CONDition section of the QUEStionable register.

The command does not delete the contents of the EVENT section.

**Usage:**              Query only

---

---

**STATus:QUESTIONable:FREQuency:CONDition?**

This command reads out the CONDition section of the QUEStionable register.

The command does not delete the contents of the EVENT section.

**Usage:** Query only

---

**STATus:QUESTIONable:LIMit:CONDition?**

This command reads out the CONDition section of the QUEStionable register.

The command does not delete the contents of the EVENT section.

**Usage:** Query only

---

**STATus:QUESTIONable:POWer:CONDition?**

This command reads out the CONDition section of the QUEStionable register.

The command does not delete the contents of the EVENT section.

**Usage:** Query only

---

**STATus:QUESTIONable:ENABle <DecimalValue>**

This command controls the ENABle part of the QUEStionable register.

The ENABle part allows true conditions in the EVENT part of the status register to be reported in the summary bit. If a bit is 1 in the enable register and its associated event bit transitions to true, a positive transition will occur in the summary bit reported to the next higher level.

**Parameters:**

<DecimalValue> Range: 0 to 65535

---

**STATus:QUESTIONable:FREQuency:ENABle <DecimalValue>**

This command controls the ENABle part of the QUEStionable register.

The ENABle part allows true conditions in the EVENT part of the status register to be reported in the summary bit. If a bit is 1 in the enable register and its associated event bit transitions to true, a positive transition will occur in the summary bit reported to the next higher level.

**Parameters:**

<DecimalValue> Range: 0 to 65535

---

**STATus:QUESTIONable:LIMit:ENABle <DecimalValue>**

This command controls the ENABle part of the QUEStionable register.

The ENABLE part allows true conditions in the EVENT part of the status register to be reported in the summary bit. If a bit is 1 in the enable register and its associated event bit transitions to true, a positive transition will occur in the summary bit reported to the next higher level.

**Parameters:**

<DecimalValue>      Range:      0 to 65535

**STATus:QUESTIONable:POWER:ENABLE** <DecimalValue>

This command controls the ENABLE part of the QUESTIONable register.

The ENABLE part allows true conditions in the EVENT part of the status register to be reported in the summary bit. If a bit is 1 in the enable register and its associated event bit transitions to true, a positive transition occurs in the summary bit reported to the next higher level.

**Parameters:**

<DecimalValue>      Range:      0 to 65535

**STATus:QUESTIONable:NTRansition** <DecimalValue>

This command controls the Negative TRansition part of the QUESTIONable register.

Setting a bit causes a 1 to 0 transition in the corresponding bit of the associated register. The transition also writes a 1 into the associated bit of the corresponding EVENT register.

**Parameters:**

<DecimalValue>      Range:      0 to 65535

**Example:**              STAT:QUES:NTR 65535

**STATus:QUESTIONable:FREQuency:NTRansition** <DecimalValue>

This command controls the Negative TRansition part of the QUESTIONable register.

Setting a bit causes a 1 to 0 transition in the corresponding bit of the associated register. The transition also writes a 1 into the associated bit of the corresponding EVENT register.

**Parameters:**

<DecimalValue>      Range:      0 to 65535

**Example:**              STAT:QUES:NTR 65535

**STATus:QUESTIONable:LIMit:NTRansition** <DecimalValue>

This command controls the Negative TRansition part of the QUESTIONable register.

Setting a bit causes a 1 to 0 transition in the corresponding bit of the associated register. The transition also writes a 1 into the associated bit of the corresponding EVENT register.

**Parameters:**

<DecimalValue>      Range:      0 to 65535

**Example:**

STAT:QUES:NTR 65535

---

**STATus:QUESTIONable:POWER:NTRansition** <DecimalValue>

This command controls the Negative TRansition part of the QUESTionable register.

Setting a bit causes a 1 to 0 transition in the corresponding bit of the associated register. The transition also writes a 1 into the associated bit of the corresponding EVENT register.

**Parameters:**

<DecimalValue>      Range:      0 to 65535

**Example:**

STAT:QUES:NTR 65535

---

**STATus:QUESTIONable:PTRansition** <DecimalValue>

This command control the Positive TRansition part of the QUESTionable register.

Setting a bit causes a 0 to 1 transition in the corresponding bit of the associated register. The transition also writes a 1 into the associated bit of the corresponding EVENT register.

**Parameters:**

<DecimalValue>      Range:      0 to 65535

---

**STATus:QUESTIONable:FREQuency:PTRansition** <DecimalValue>

This command control the Positive TRansition part of the QUESTionable register.

Setting a bit causes a 0 to 1 transition in the corresponding bit of the associated register. The transition also writes a 1 into the associated bit of the corresponding EVENT register.

**Parameters:**

<DecimalValue>      Range:      0 to 65535

---

**STATus:QUESTIONable:LIMit:PTRansition** <DecimalValue>

This command control the Positive TRansition part of the QUESTionable register.

Setting a bit causes a 0 to 1 transition in the corresponding bit of the associated register. The transition also writes a 1 into the associated bit of the corresponding EVENT register.

**Parameters:**

<DecimalValue>      Range:      0 to 65535

---

**STATus:QUESTionable:POWer:PTRansition** <DecimalValue>

This command control the Positive TRansition part of the QUESTionable register.

Setting a bit causes a 0 to 1 transition in the corresponding bit of the associated register. The transition also writes a 1 into the associated bit of the corresponding EVENT register.

**Parameters:**

<DecimalValue>      Range:      0 to 65535

# 14 Menu and softkey overview

This chapter shows an overview of all instrument functions in the form of softkey and menu overview.

- [General functions](#)..... 375
- [Functions of the power meter](#).....383
- [Functions of the wizard](#)..... 393
- [Functions of the cable & antenna](#).....395
- [Functions of the vector network analyzer](#).....401
- [Functions of the vector voltmeter](#).....408

## 14.1 General functions

- [General R&S ZNH setup](#).....375
- [File management](#)..... 381
- [Operating mode selection](#)..... 382

### 14.1.1 General R&S ZNH setup



#### R&S ZNH options

<sup>1</sup> only available with R&S ZNH-K10

<sup>2</sup> only available with R&S ZNH-K45

<sup>3</sup> only available with R&S ZNH-K66

The [SETUP] key opens the setup menu that contains functionality to set up the R&S ZNH in general and functionality to set up the measurement.

Softkey	Menu or dialog items	Parameters	Parameters selection
Config Overview (CAT mode)	Mode	DTF	SWR
			Return Loss
		DTF & SWR	
		DTF & Return Loss	
		Return Loss	
		SWR	
		Cable Loss	
		Phase	Unwrap
			Wrap
		Smith Chart	

Softkey	Menu or dialog items	Parameters	Parameters selection
		Transmission	
		RL + Trans	
	Stimulus	Start Freq	
		Stop Freq	
		Center Freq	
		Span	
		Span Mode	Auto
			Manual
	Cable	Cable Model	Mark
			Edit
			Preview
			Load
			Refresh
			Exit
		User Model	Yes
			No
		Frequency	
		Velocity Factor	
		Loss	
		Use Waveguide	Yes
			No
	Cutoff Frequency		
	Amplitude	Port Power	
		Range	Leveled
			Maximum
		Rcv Attn Port1	
		Rcv Attn Port2	
Reference Level			
Scale			
Auto Scale			
Split Screen	Current Trace (Trace1, Trace2)		
Analysis	AVG	OFF	
		ON	



Softkey	Menu or dialog items	Parameters	Parameters selection	
		Avg Count		
		Points		
		Distance	Start Dist	
			Stop Dist	
			Length Unit	Meter
				Feet
Config Overview (VNA mode)	Mode	MEAS	S-Parameters (S11, S21, S12, S22)	
			<sup>3</sup> Ratios (b1/a1(P1), b2/a1(P1), b1/a2(P2), b2/a2(P2))	
			<sup>3</sup> Wave (a1(P1), b1(P1), b2(P1), a2(P2), b2(P2), b1(P2))	
		DISPLAY	Single, Split-Hor, Split-Vert, Triple, Quad	
		FORMAT	dB Mag, Phase, Smith, Phase Unwr, SWR, Lin Mag, Real, Imag, Polar, Group Delay	
		APPLY		
		CANCEL		
		Stimulus		Start Freq
	Stop Freq			
	Center Freq			
	Span			
	Analysis		Points	
			AVG	OFF
				ON
			Avg Count	
			Smoothing	On
				Off
			Aperture	Auto
				Manual
	Amplitude		Port Power	
			Range	Leveled

Softkey	Menu or dialog items	Parameters	Parameters selection
			Maximum
		Rcv Attn Port1	
		Rcv Attn Port2	
		Trace	Trace1, Trace2, Trace3, Trace4
		Reference level	
		Scale	
		Coupled Traces	On
			Off
Config Overview ( <sup>2</sup> VVM mode)	Mode	Trace	S11
			S21
	Stimulus	Center Freq	
		Span	
	Amplitude	Port Power	
		Attenuation	
	Analysis	AVG	ON
			OFF
	Avg Count		
Instrument Setup	Hardware	Auto Accessory Detection	On
			Off
		Detected Accessory	
		BNC	Trigger Input
			Reference Input
		<sup>1</sup> Internal DC Bias	Off
	Internal DC Bias Level (Volt)	2V	
	GPS	GPS	On
			Off
		Show GPS Information	On
			Off
		Coordinate Format	dd° mm' ss.sss"
	dd° mm.mmm'		
	LAN	MAC Address	On, Off
DHCP		On	

Softkey	Menu or dialog items	Parameters	Parameters selection
			Off
		IP Address	
		Subnet Mask	
		Gateway	
	Date and Time	Set Date	
		Set Time	
		Time Zone	
	Regional	Language	English, French, German, Spanish, Italian, Portuguese, Japanese, Chinese, Korean, Russian, Hungarian, Traditional Chinese
		Date Format	dd/mm/yyyy, mm/dd/yyyy
		Length Unit	Feet Meter
	Display	Display Backlight	0 - 100 %
		Display Color Scheme	Color Black & White Printer Friendly
		Keyboard Backlight	0 - 100 %
		Keyboard Backlight Delay	1 - 10 s
		Touch Interface	On Off
	Audio	Key Click Volume	0 - 100 %
		System Beeper Volume	0 - 100 %
		Beep on Power Overboard	On Off
	Power	Current Power Source	
		Battery Level	
		Battery Low Level	0 - 100 %
		Battery Low Level Beep	Repetitive Once Off

Softkey	Menu or dialog items	Parameters	Parameters selection
		Auto Power Up on AC	On
			Off
	Default Calibration	Perform Default Calibration	
		Last Calibration Date	
		Last Calibration Frequency	
		Last Calibration Cal Kit	
Calibration Kit	Calibration Kit		
Reset	Reset Factory Settings	Factory Reset	
User Preference	Site Name	Site Name	
		User	
		Name	
		Comments	
	Preset Key	Preset Mode	User Defined
			Default
		Preset Dataset	
		Discard Calibration Data	On
		Off	
	Working Directory	User working directory	On
			Off
		Working directory	\Public
	Capture	Capture Screen	On
			Off
		Capture Dataset	On
			Off
		Capture GPX	On
			Off
		Default Filename	Measurement
		Filename Counter Starts at	001
Capture Screen Format	PNG		
	JPG		
Dataset	Default Dataset Name	Dataset	

Softkey	Menu or dialog items	Parameters	Parameters selection
		Use Instrument Calibration	On
			Off
	Cable & Antenna	Dedicated DTF Frequency	On
			Off
	Documentation	Export Documentation	Export
HW/SW info	Hardware	Instrument Model	
		Instrument Serial Number	
		Mainboard Part Number	
		Mainboard Revision	
		Mainboard Serial Number	
		Frontboard Part Number	
		Frontboard Revision	
		Frontboard Serial Number	
	Controller Version		
		Software	Software Version
		Software Version Postfix	
Installed Options	Option Administration	Device ID	
		Install Option	
	Installation Status		
Exit			

### 14.1.2 File management

The [SAVE/RECALL] key opens the file manager that contains functionality to manage datasets and other files.

Softkey	Menu or dialog items	Parameters	Parameters selection
Save	On-screen KB (see <a href="#">Chapter 5.2, "On-screen keyboard"</a> , on page 77)		
	Exit		
Recall	Preview	Prev	
		Next	
		Recall	

Softkey	Menu or dialog items	Parameters	Parameters selection	
		Exit		
	Load			
	Refresh			
	Exit			
Recall Screenshot	Preview	Prev		
		Next		
		Exit		
	Refresh			
	Exit			
Export	Export SnP			
	Export CSV			
File Manager	Mark			
	Edit	Rename		
		Cut		
		Copy		
		Paste		
		Delete		
	Preview	Prev		
		Next		
		Exit		
	Load			
	Refresh			
Exit				

### 14.1.3 Operating mode selection



<sup>1</sup> only available with R&S ZNH-K45

<sup>2</sup>Available only if R&S ZNH-K9 is installed.

The [MODE] key opens the mode menu that contains functionality to select the operating mode of the R&S ZNH.

Softkey	Menu or dialog items	Parameters	Parameters selection
Network Analyzer	See <a href="#">Chapter 8, "Vector network analysis"</a> , on page 153		
Cable & Antenna	See <a href="#">Chapter 14.4.1, "Cable &amp; Antenna measurements"</a> , on page 395		
<sup>1</sup> Vector Voltmeter	See <a href="#">Chapter 9, "Vector voltmeter"</a> , on page 190		
<sup>2</sup> Power Meter	See <a href="#">Chapter 10, "Power meter"</a> , on page 193)		

## 14.2 Functions of the power meter

This section contains all softkeys and menus that are available in power meter mode.

- [Power meter measurements](#)..... 383
- [Frequency parameters](#)..... 387
- [FORMAT parameters](#)..... 388
- [SCALE parameters](#)..... 389
- [Sweep configuration](#)..... 390
- [Limits line parameters](#)..... 390
- [Trace parameters](#)..... 391
- [Marker parameters](#)..... 391
- [CAL parameters](#)..... 392

### 14.2.1 Power meter measurements



The power meter is available only if you have installed option R&S ZNH-K9.

The [MEAS] key opens a menu that contains the functionality to configure measurements with the power meter.

#### Power Meter

Softkey	Menu or dialog items	Parameters	Parameters selection
<sup>1</sup> Meas Mode	<sup>2</sup> Average		
	<sup>2</sup> Power vs Freq		
Freq			
Unit	dBm		

Softkey	Menu or dialog items	Parameters	Parameters selection
	dB $\mu$ V		
	dBmV EMF		
	dB $\mu$ V EMF		
	W		
	dB $\mu$ V/m		
	V/m <sup>2</sup>		
	dB Rel		
Zero			
To Ref	Gain		
Signal Gen	SigGen On		
	Port Power		
	Port 1		
	Port 2		

<sup>1</sup>Softkey available only if K9 and K69 are installed. See "[Power vs frequency measurement](#)" on page 386.

<sup>2</sup>"Average" is available for K9 option, "Power vs Freq" is available for K69 option.

#### Directional Power Meter with R&S FSH-Z14 & R&S FZH-Z44



The directional power meter is available only if you have installed option R&S ZNH-K9.

Softkey	Menu or dialog items	Parameters	Parameters selection
Fwd Pwr Display	Average		
	Peak Envelope		
Freq <sup>1</sup>			
Unit	Forward Power	dBm	
		W	
		dB	
	Reflected Power	dBm	
		W	
		VSWR	
		dB (Return Loss)	
Zero			



Softkey	Menu or dialog items	Parameters	Parameters selection
To Ref			
Standard	Correction Off		
	GSM		
	EDGE		
	3GPPWCDMA <sup>2</sup>		
	cdmaOne <sup>2</sup>		
	cdma200 1x <sup>2</sup>		
	DVB-T <sup>2</sup>		
	DVB <sup>2</sup>		
	TETRA		
	USER	4 kHz	
	200 kHz		
	600 kHz		

<sup>1</sup> If "Freq Mode" (see [Frequency parameters](#)) is set to "Channel", the softkey displays "Channel".

<sup>2</sup> Only for R&S FSH-Z44

### Optic Power Measurement with ODM UPM 100

Softkey	Menu or dialog items	Parameters	Parameters selection
Wavelength			
Unit	dBm		
	dB $\mu$ V		
	W		
	dB Rel		
To Ref			

### Pulse Power Measurement



The pulse power measurement is available only if you have installed option R&S ZNH-K29.

*Table 14-1: Pulse power measurement with numeric mode*

Softkey	Menu or dialog items	Parameters	Parameters selection
Meas Mode	Average		
	Power vs Time		

Softkey	Menu or dialog items	Parameters	Parameters selection
Freq			
Unit	dBm		
	W		
Zero			
To Ref			
Meas Time	Short		
	Normal		
	Long		

**Table 14-2: Pulse power measurement with trace mode**

Softkey	Menu or dialog items	Parameters	Parameters selection
Meas Mode	Average		
	Pwr vs Time		
Freq			
Unit	dBm		
	W		
Zero			
Algorithm	Histogram		
	Integration		
	Peak		
Ref Power Config	Low Ref Power	0 - 100 %	
	High Ref Power	0 - 100 %	
	Ref Power	0 - 100 %	
	Set to Default		
	Related to Power		
	Related to Voltage		

### Power vs frequency measurement



The power vs frequency measurement is available only if you have installed option R&S ZNH-K69.

**Table 14-3: Power vs frequency measurement**

Softkey	Menu or dialog items	Parameters	Parameters selection
<sup>1</sup> Meas Mode	<sup>2</sup> Average		
	<sup>2</sup> Power vs Freq		
Freq Config			
Unit	dBm		
	W		
Calibrate			
Format	Gain		
	Absolute Power		
Signal Gen	SigGen On		
	Port Power		
	Port 1		
	Port 2		

<sup>1</sup>Softkey available only if K9 and K69 are installed. See "[Power Meter](#)" on page 383

<sup>2</sup>"Average" is available for K9 option, "Power vs Freq" is available for K69 option.

## 14.2.2 Frequency parameters

The [FREQ / DIST] key opens a menu that contains the functionality to set the frequency.

**Table 14-4: Optic Power Measurement**

Softkey	Menu or dialog items	Parameters	Parameters selection
Wavelength			

**Table 14-5: Power Meter, Directional Power Meter, Channel Power Meter, Pulse Power Measurement**

Softkey	Menu or dialog items	Parameters	Parameters selection
<sup>1</sup> Frequency			
Freq Mode	<sup>2</sup> Channel		
	Select Downlink	Refresh	
		Load	
		Exit	
	Select Uplink	Refresh	
		Load	
		Exit	

Softkey	Menu or dialog items	Parameters	Parameters selection
	Set to Downlink		
	Set to Uplink		

<sup>1</sup> If "Freq Mode" is set to "Channel", the softkey displays "Channel".

<sup>2</sup> If "Freq Mode" is previously configured to "Channel", the menu item displays "Frequency".

**Table 14-6: Power vs frequency measurement**

Softkey	Menu or dialog items	Parameters	Parameter selection
Src Freq		Src Start	
		Src Stop	
		Src Center	
		Span	
		Back	
Span			
Rcv Freq		Rcv Start	
		Rcv Stop	
		Rcv Center	
		Span	
		Back	
Freq Conversion	Down, USB		
	Down, LSB		
	Up, USB		
Points			

### 14.2.3 FORMAT parameters

The [FORMAT] key contains functionality to configure measurement format parameters.

**Table 14-7: Power vs frequency measurement**

Softkey	Menu or dialog items	Parameters	Parameters selection
Format	Gain		
	Absolute Power		

## 14.2.4 SCALE parameters

The [SCALE/AMPT] key contains functionality to configure level parameters.

**Table 14-8: Power Meter, Directional Power Meter**

Softkey	Menu or dialog items	Parameters	Parameters selection
Unit	dBm		
	dB $\mu$ V		
	dBmV EMF		
	dB $\mu$ V EMF		
	W		
	dB $\mu$ V/m		
	V/m		
	W/m <sup>2</sup>		
	dB Rel		
Offset			

**Table 14-9: Pulse Power Measurement**

Softkey	Menu or dialog items	Parameters	Parameters selection
Ref Level	-70 to 30 dBm		
Range	Scale Adjust		
	100 dB (10.0dB/Div)		
	50 dB (5.0dB/Div)		
	50 dB (5.0dB/Div)		
	30 dB (3.0dB/Div)		
	20 dB (2.0dB/Div)		
	10 dB (1.0dB/Div)		
	50 dB (0.5dB/Div)		
Unit	dBm		
	W		
Offset			

**Table 14-10: Power vs Frequency Measurement**

Softkey	Menu or dialog items	Parameters	Parameters selection
Ref Level			
Range	Auto Range		
	Range		

Softkey	Menu or dialog items	Parameters	Parameters selection
	Ref Position		
Unit	dBm		
	W		

### 14.2.5 Sweep configuration

The [SWEEP] key opens a menu that contains functionality to configure the sweep.

**Table 14-11: Power Meter, Directional Power Meter**

Softkey	Menu or dialog items	Parameters	Parameters selection
Meas Time	Short		
	Normal		
	Long		

**Table 14-12: Pulse Power Measurement**

Softkey	Menu or dialog items	Parameters	Parameters selection
Trace Time		52 us to 1 s	
Conf Meas			
Single Meas			
Trigger	Free Run		
	Positive		
	Negative		
	Trigger Level	-30 to 20 dBm	
	Trigger Delay	-51.1875us to 53 s	
	Trigger Hysteresis	0.1 to 10 dB	
	Dropout Time	0 to 10s	

**Table 14-13: Power vs Frequency Measurement**

Softkey	Menu or dialog items	Parameters	Parameters selection
Single Sweep			
Continuous Sweep			

### 14.2.6 Limits line parameters

The [LINES] key opens a menu that contains functionality to configure the limits line.

**Table 14-14: Power Meter, Optic Power Meter**

Softkey	Menu or dialog items	Parameters	Parameters selection
Show Limit Lines			
Upper Limit	Set Threshold		
	Remove		
Lower Limit	Set Threshold		
	Remove		
Auto Beep			

### 14.2.7 Trace parameters

The [TRACE] key opens a menu that contains functionality to configure the trace.

**Table 14-15: Pulse Power Measurement**

Softkey	Menu or dialog items	Parameters	Parameters selection
Trace Mode	Clear/Write		
	Average		
Detector	Average		
	Max Peak		
Show	Enable Trace 2		
	Enable Memory 1		
	Enable Memory 2		
Trace>Memory			

**Table 14-16: Power vs Frequency Measurement**

Softkey	Menu or dialog items	Parameters	Parameters selection
Trace Mode	Clear/Write		
	Average		
Show Memory			
Trace > Memory			

### 14.2.8 Marker parameters

The [MARKER] key opens a menu that contains functionality to configure the marker on the trace

**Table 14-17: Pulse Power Measurement**

Softkey	Menu or dialog items	Parameters	Parameters selection
New Marker			
Marker Type			
Delete Marker	Delete Selected		
	Delete All Delta		
	Delete All		
Select Marker			
Set Marker	Search Range		
	Set To Peak		
	Set To Next Peak		
	Set To Minimum		
	All Marker To Peak		
	Center=Marker Freq		
	Ref Level=Marker Level		

**Table 14-18: Power vs Frequency Measurement**

Softkey	Menu or dialog items	Parameters	Parameters selection
New Marker			
Marker Type			
Delete Marker	Delete Selected		
	Delete All Delta		
	Delete All		
Select Marker			
Set Marker	Search Range		
	Set To Peak		
	Set To Next Peak		
	Set To Minimum		
	All Marker To Peak		
	Center=Marker Freq		
	Ref Level=Marker Level		

### 14.2.9 CAL parameters

The [CAL] key opens a menu that contains functionality to perform calibration on the power measurement.



Table 14-19: Power vs Frequency Measurement

Softkey	Menu or dialog items	Parameters	Parameters selection
Calibrate			

## 14.3 Functions of the wizard

This section contains all softkeys and menus that are available in the measurement WIZARD.

- [Measurement wizard](#).....393

### 14.3.1 Measurement wizard

The [WIZARD] key opens a menu that contains the functionality to perform wizard measurement.

Softkey	Menu or dialog items	Parameters	Parameters selection
Load Meas Set	Edit	Rename	
		Cut	
		Copy	
		Paste	
		Delete	
	Refresh		
	Load		
Exit			
Start Meas	Continue	Next Meas	Continue
			Interrupt
			Skip
			Finish Wizard
			Cancel
		Repeat Meas	
		Interrupt	Leave Menu <sup>1</sup>
			Resume Sequence
			Cancel
		Finish Wizard	
	Cancel		
Interrupt	Leave Menu <sup>1</sup>		

Softkey	Menu or dialog items	Parameters	Parameters selection	
		Resume Sequence		
		Cancel	Yes No	
	Skip	Continue		Next Meas
				Repeat Meas
				Interrupt
				Finish Wizard
				Cancel
		Interrupt		Leave Menu <sup>1</sup>
				Resume Sequence
				Cancel
		Skip		Continue
				Interrupt
			Skip	
			Finish Wizard	
		Finish Wizard		
		Cancel	Yes No	
	Finish Wizard			
Cancel	Yes		Save Result	
			Discard Result	
	No			
Meas Setting	General	Measurement Definition		
		User		
		Number of Steps		
		Description		
	Site	Site Number		
		Comments		
		GPS Position		
Cable Definition	Use Wizard Cable Settings			
	Cable Model			
Meas Spec				

Softkey	Menu or dialog items	Parameters	Parameters selection	
Meas Results	Mark			
	Edit	Rename		
		Cut		
		Copy		
		Paste		
		Delete		
	Preview	Prev		
		Next		
		Exit		
	Refresh			
Exit				
Exit				

<sup>1</sup>Press [WIZARD] key to resume back the wizard measurement.

## 14.4 Functions of the cable & antenna

This section contains all softkeys and menus that are available in the measurement Cable & Antenna.

- [Cable & Antenna measurements](#)..... 395
- [FREQ/DIST parameters](#)..... 396
- [SCALE parameters](#)..... 397
- [SWEEP parameters](#)..... 398
- [FORMAT parameters](#)..... 398
- [TRACE parameters](#)..... 398
- [Limits line parameters](#)..... 399
- [MARKER parameters](#)..... 400
- [CAL parameters](#)..... 401

### 14.4.1 Cable & Antenna measurements

The [MEAS] key opens a menu that contains the functionality to configure the cable & antenna measurements.

Softkey	Menu or dialog items	Parameters	Parameters selection
Meas Mode	Return Loss		
	Transmission		

Softkey	Menu or dialog items	Parameters	Parameters selection			
	RL +Trans					
	Cable Loss	Normal				
		(Open + Short) / 2				
	DTF	Cable Config	Cable Model			
			User Model			
			User Settings	Frequency		
				Velocity Factor		
				Loss		
			Clear Model			
			Use Waveguide			
			Cutoff Freq			
	DTF/TDR List					
	List Threshold					
DTF + Return Loss						
TDR						
DTF + TDR						
Driving Port	Port 1					
	Port 2					

#### 14.4.2 FREQ/DIST parameters

The [FREQ/DIST] key opens a menu that contains the functionality to set the frequency and cable distance.

*Table 14-20: DTF only*

Softkey	Menu or dialog items	Parameters	Parameters selection
Start Dist			
Stop Dist			
DTF Center Freq			
DTF Span	Coupled		
	Auto Span		
	Auto Points		
	Manual		

Softkey	Menu or dialog items	Parameters	Parameters selection
	DTF Span		
DTF Start Freq			
DTF Stop Freq			

Softkey	Menu or dialog items	Parameters	Parameters selection
Start			
Stop			
Center			
Span			
Signal Standard	Select Downlink	Mark	
		Edit	
		Preview	
		Load	
		Refresh	
		Exit	
	Select Uplink	Mark	
		Edit	
		Preview	
		Load	
		Refresh	
		Exit	
	Set to Downlink		
	Set to Uplink		
	Set to Uplink + Downlink		

### 14.4.3 SCALE parameters

The [SCALE / AMPT] key opens a menu that contains the functionality to set the vertical axis of the measurement diagram.

Softkey	Menu or dialog items	Parameters	Parameters selection
Auto Scale			
Range			
Ref Value			
Ref Pos			

Softkey	Menu or dialog items	Parameters	Parameters selection
Port Config	Port Power		
	Range Leveled		
	Range Maximum		
	Rcv Attn Port 1		
	Rcv Attn Port 2		
	Rf Off		

#### 14.4.4 SWEEP parameters

The [SWEEP] key opens a menu that contains the functionality to set the sweep.

Softkey	Menu or dialog items	Parameters	Parameters selection
Number of Points			
Hold			
Meas BW	Frequency		
Single Sweep			
Continuous Sweep			

#### 14.4.5 FORMAT parameters

The [FORMAT] key opens a menu that contains the functionality to set the measurement format.

Softkey	Menu or dialog items	Parameters	Parameters selection
dB Mag			
Lin Mag			
Phase	Wrap		
	Unwrap		
Smith			
SWR			

#### 14.4.6 TRACE parameters

The [TRACE] key opens a menu that contains the functionality to set the trace.

Softkey	Menu or dialog items	Parameters	Parameters selection
Trace Mode	Average Off		
	Average On		
Smoothing	Smoothing Off		
	Smoothing On		
	Aperture Auto		
	Aperture Manual		
Show Memory			
Trace►Memory			
Select Trace			
Trace Math	Off		
	Trace - Memory		
	Memory / Trace		

#### 14.4.7 Limits line parameters

The [LINES] key opens a menu that contains functionality to configure the limits line.

Softkey	Menu or dialog items	Parameters	Parameters selection
Display Line			
Show Limit Lines			
Upper Limit	Set Threshold		
	Load From File		
	(X) Stimulus		
	(Y) Response		
	Remove		
Lower Limit	Set Threshold		
	Load From File		
	(X) Stimulus		
	(Y) Response		
	Remove		
Select Trace			
Auto Beep			

### 14.4.8 MARKER parameters

The [MARKER] key opens a menu that contains the functionality to set the marker.

Softkey	Menu or dialog items	Parameters	Parameters selection	
New Marker				
Marker Type				
Delete Marker	Delete Selected			
	Delete All Data			
	Delete All			
Select Marker				
Marker Mode	Normal			
	dB Magn + Phase			
	Lin Magn + Phase (Rho)			
	Real + Imag			
	R + jX			
	G + jB			
	SWR			
	Delay			
Set Marker	Coupled Marker			
	View List			
	Search Range	Search Range 1	Lower Limit	
			Upper Limit	
	Search Range 2	Search Range 2	Lower Limit	
			Upper Limit	
	Selected Marker	Selected Marker	Search Range Off	
			Search Range 1	
			Search Range 2	
	All Markers	All Markers	Search Range Off	
			Search Range 1	
			Search Range 2	
	Select Marker	Select Marker		
	Exit	Exit		
Set To Peak				
Set To Next Peak				



Softkey	Menu or dialog items	Parameters	Parameters selection
	Set To Minimum		
	All Marker To Peak		

### 14.4.9 CAL parameters

The [CAL] key opens a menu that contains the functionality to calibrate the instrument.

Softkey	Menu or dialog items	Parameters	Parameters selection
Calibrate	Cal Config		
	Start Cal		
	Start Auto Cal		
	Cancel		
Offsets	Length Offset P1		
	Length Offset P2		
User Calibration			
Last Calibration			

## 14.5 Functions of the vector network analyzer

This section contains all softkeys and menus that are available in the measurement Vector Network Analyzer.

- [Vector network analyzer measurements](#).....401
- [FREQ/DIST parameters](#).....403
- [SCALE parameters](#).....403
- [SWEEP parameters](#).....404
- [FORMAT parameters](#).....404
- [TRACE parameters](#).....405
- [Limits Line parameters](#).....406
- [MARKER parameters](#).....406
- [CAL parameters](#).....407

### 14.5.1 Vector network analyzer measurements

The [MEAS] key opens a menu that contains the functionality to configure the vector network analyzer measurements.

Softkey	Menu or dialog items	Parameters	Parameters selection			
S11						
S21						
S12						
S22						
Select Trace						
More	S-parameters					
	<sup>1</sup> Ratios	b1/a1(P1)				
		b2/a1(P1)				
		b1/a2(P2)				
		b2/a2(P2)				
		More	Port 1	Numerator		
				Denominator		
				Driving Port	Port 1	
	Port 2					
	Back		Back			
	<sup>1</sup> Wave	a1				
		b1				
		a2				
		b2				
		Driving Port	Port 1			
			Port 2			
	Back					
	<sup>2</sup> Mixed Mode	Sdd11				
		Scd11				
		Sdc11				
		Scd11				
	Back					

<sup>1</sup> Available only with R&S ZNH-K66

<sup>2</sup> Available only with R&S ZNH-K47

### 14.5.2 FREQ/DIST parameters

The [FREQ/DIST] key opens a menu that contains the functionality to set the frequency and signal standard.

Softkey	Menu or dialog items	Parameters	Parameters selection	
Start				
Stop				
Center				
Span				
<sup>1</sup> Time Domain	Time Domain			
	Time Gate			
	Time X-Axis			
	Distance X-Axis			
	Time Domain Range			Start Time / Start Distance
				Stop Time / Stop Distance
				Center Time / Center Distance
				Time Span / Distance Span
	Time Gate Range			
	Time Domain Config			
	Time Gate Config			
Low Pass Config				

<sup>1</sup> Available only with R&S ZNH-K68

### 14.5.3 SCALE parameters

The [SCALE / AMPT] key opens a menu that contains the functionality to set the vertical axis of the measurement diagram.

Softkey	Menu or dialog items	Parameters	Parameters selection
Auto Scale			
Scale			
Ref Value			
Ref Pos			
Coupled Traces			

Softkey	Menu or dialog items	Parameters	Parameters selection
Port Config	Port Power		
	Range Leveled		
	Range Maximum		
	Rcv Attn Port 1		
	Rcv Attn Port 2		
	Rf Off		

#### 14.5.4 SWEEP parameters

The [SWEEP] key opens a menu that contains the functionality to set the sweep.

Softkey	Menu or dialog items	Parameters	Parameters selection
Number of Points			
Meas BW	Frequency		
Sweep	Auto		
	Manual		
Trigger	Free Run		
	External Rise		
	External Fail		
	Trigger Delay		
Single Sweep			
Continuous Sweep			

#### 14.5.5 FORMAT parameters

The [FORMAT] key opens a menu that contains the functionality to set the measurement format.

Softkey	Menu or dialog items	Parameters	Parameters selection
dB Mag			
Lin Mag			
Phase	Wrap		
	Unwrap		
Smith			
SWR			
More	Real		

Softkey	Menu or dialog items	Parameters	Parameters selection
	Imag		
	Polar		
	Group Delay		
	Impedance		
	Back		

### 14.5.6 TRACE parameters

The [TRACE] key opens a menu that contains the functionality to set the trace.

Softkey	Menu or dialog items	Parameters	Parameters selection
New Trace	Add Trace		
	Add Trace + Disp		
Delete Trace	Delete Selected		
	Delete All		
Trace Mode	Average Off		
	Average On		
	Smoothing Off		
	Smoothing On		
	Aperture Auto		
	Aperture Manual		
Memory	Show Memory	Memory 1	
		Memory 2	
		Memory 3	
		Memory 4	
	Trace►Memory		
	Select Trace		
	Trace Math	Off	
		Trace - Memory	
Trace / Memory			
Select Trace			
Display	Single		
	Dual-Hor		
	Dual-Vert		

Softkey	Menu or dialog items	Parameters	Parameters selection
	Triple		
	Quad		

### 14.5.7 Limits Line parameters

The [LINES] key opens a menu that contains functionality to configure the limits line.

Softkey	Menu or dialog items	Parameters	Parameters selection
Display Line			
Show Limit Lines			
Upper Limit	Set Threshold		
	Load From File		
	(X) Stimulus		
	(Y) Response		
	Remove		
Lower Limit	Set Threshold		
	Load From File		
	(X) Stimulus		
	(Y) Response		
	Remove		
Select Trace			
Auto Beep			

### 14.5.8 MARKER parameters

The [MARKER] key opens a menu that contains the functionality to set the marker.

Softkey	Menu or dialog items	Parameters	Parameters selection
New Marker			
Marker Type			
Delete Marker	Delete Selected		
	Delete All Data		
	Delete All		
Select Marker			
Marker Mode	Normal		

Softkey	Menu or dialog items	Parameters	Parameters selection
	dB Magn + Phase		
	Lin Magn + Phase (Rho)		
	Real + Imag		
	R + jX		
	G + jB		
	SWR		
	Delay		
Set Marker	Coupled Marker		
	View List		
	Search Range	Search Range 1	Lower Limit
			Upper Limit
		Search Range 2	Lower Limit
			Upper Limit
		Selected Marker	Search Range Off
			Search Range 1
	Search Range 2		
	All Markers	Search Range Off	
		Search Range 1	
		Search Range 2	
	Select Marker		
	Exit		
	Set To Peak		
Set To Next Peak			
Set To Minimum			
All Marker To Peak			

### 14.5.9 CAL parameters

The [CAL] key opens a menu that contains the functionality to calibrate the instrument.

Softkey	Menu or dialog items	Parameters	Parameters selection
Calibrate	Cal Config		
	Start Cal		
	Start Auto Cal		

Softkey	Menu or dialog items	Parameters	Parameters selection
	Cancel		
Offsets	Offset Settings	Length Config P1	Delay
			Electrical Length
			Mechanical Length
			Permittivity:
			Velocity Factor
		Loss Config P1	Loss at DC
			Loss at 1st Freq
			1st Freq for Loss
			Use 2nd Freq
			Loss at 2nd Freq
			2nd Freq for Loss
		Length Config P2	Delay
			Electrical Length
			Mechanical Length
			Permittivity:
			Velocity Factor
		Loss Config P2	Loss at DC
			Loss at 1st Freq
			1st Freq for Loss
			Use 2nd Freq
Loss at 2nd Freq			
2nd Freq for Loss			
	Back		
User Calibration			

## 14.6 Functions of the vector voltmeter

This section contains all softkeys and menus that are available in the measurement vector voltmeter.

- [Vector voltmeter measurements](#)..... 409
- [FREQ/DIST parameters](#).....409
- [SCALE parameters](#)..... 409



- [SWEEP parameters](#).....409
- [TRACE parameters](#).....410
- [CAL parameters](#).....410

### 14.6.1 Vector voltmeter measurements

The [MEAS] key opens a menu that contains the functionality to configure the vector voltmeter measurements.

Softkey	Menu or dialog items	Parameters	Parameters selection
S11			
S21			
> Ref			

### 14.6.2 FREQ/DIST parameters

The [FREQ/DIST] key opens a menu that contains the functionality to set the center frequency.

Softkey	Menu or dialog items	Parameters	Parameters selection
Center			

### 14.6.3 SCALE parameters

The [SCALE / AMPT] key opens a menu that contains the functionality to set the power and attenuation of the measurement.

Softkey	Menu or dialog items	Parameters	Parameters selection
Power			
Attenuation			

### 14.6.4 SWEEP parameters

The [SWEEP] key opens a menu that contains the functionality to set the sweep.

Softkey	Menu or dialog items	Parameters	Parameters selection
Meas BW	Frequency		
Hold			
Trigger	Free Run		
	External Rise		

Softkey	Menu or dialog items	Parameters	Parameters selection
	External Fail		
	Trigger Delay		
Single Sweep			
Continuous Sweep			

### 14.6.5 TRACE parameters

The [TRACE] key opens a menu that contains the functionality to set the trace.

Softkey	Menu or dialog items	Parameters	Parameters selection
Trace Mode	Average Off		
	Average On		

### 14.6.6 CAL parameters

The [CAL] key opens a menu that contains the functionality to calibrate the instrument.

Softkey	Menu or dialog items	Parameters	Parameters selection
Calibrate	Cal Config		
	Start Cal		
	Start Auto Cal		
	Cancel		
Offsets	Length Offset P1		
	Length Offset P2		
User Calibration			

## 15 Contacting customer support

### Technical support – where and when you need it

For quick, expert help with any Rohde & Schwarz product, contact our customer support center. A team of highly qualified engineers provides support and works with you to find a solution to your query on any aspect of the operation, programming or applications of Rohde & Schwarz products.

### Contact information

Contact our customer support center at [www.rohde-schwarz.com/support](http://www.rohde-schwarz.com/support), or follow this QR code:



*Figure 15-1: QR code to the Rohde & Schwarz support page*

## List of commands

[SENSe:]BANDwidth[:RESolution].....	273
[SENSe:]BANDwidth[:RESolution]:AUTO.....	274
[SENSe:]BWIDth[:RESolution].....	273
[SENSe:]BWIDth[:RESolution]:AUTO.....	274
[SENSe:]CORRection:CDATa?.....	254
[SENSe:]CORRection:COAX.....	296
[SENSe:]CORRection:FREQUency:COAX.....	296
[SENSe:]CORRection:FREQUency:COAX.....	299
[SENSe:]CORRection:FREQUency:COAX.....	300
[SENSe:]CORRection:LOSS:COAX.....	296
[SENSe:]CORRection:LOSS:COAX.....	300
[SENSe:]CORRection:OFFSet<p>:AUTO:LENGth.....	257
[SENSe:]CORRection:OFFSet<p>:AUTO:LOSS.....	257
[SENSe:]CORRection:OFFSet<p>:DCLoss.....	257
[SENSe:]CORRection:OFFSet<p>:DELay.....	258
[SENSe:]CORRection:OFFSet<p>:ELIMits<l>:LEFT.....	258
[SENSe:]CORRection:OFFSet<p>:ELIMits<l>:RIGHT.....	258
[SENSe:]CORRection:OFFSet<p>:ELIMits<l>[:STATe].....	259
[SENSe:]CORRection:OFFSet<p>:FIRSt:FREQ.....	259
[SENSe:]CORRection:OFFSet<p>:FIRSt:LOSS.....	259
[SENSe:]CORRection:OFFSet<p>:LENGth.....	259
[SENSe:]CORRection:OFFSet<p>:MEChlength.....	260
[SENSe:]CORRection:OFFSet<p>:PERMittivity.....	260
[SENSe:]CORRection:OFFSet<p>:RESet.....	260
[SENSe:]CORRection:OFFSet<p>:SECond:ENABLE.....	261
[SENSe:]CORRection:OFFSet<p>:SECond:FREQ.....	261
[SENSe:]CORRection:OFFSet<p>:SECond:LOSS.....	261
[SENSe:]CORRection:OFFSet<p>:VELocity.....	261
[SENSe:]CORRection:RVELocity:COAX.....	296
[SENSe:]CORRection:RVELocity:COAX.....	300
[SENSe:]DETEctor<t>[:FUNCTion].....	251
[SENSe:]DETEctor<t>[:FUNCTion]:AUTO.....	251
[SENSe:]FREQUency:CENTer.....	264
[SENSe:]FREQUency:CENTer:STEP.....	264
[SENSe:]FREQUency:CENTer:STEP:LINK.....	264
[SENSe:]FREQUency:SETTings:COUPling:ENABLE.....	266
[SENSe:]FREQUency:SPAN.....	264
[SENSe:]FREQUency:SPAN:AUTO.....	265
[SENSe:]FREQUency:SPAN:FULL.....	265
[SENSe:]FREQUency:STARt.....	265
[SENSe:]FREQUency:STOP.....	265
[SENSe:]HARMonic:AUTO.....	328
[SENSe:]HARMonic:DLENGth:DATA.....	329
[SENSe:]HARMonic:RTIME:DATA.....	329
[SENSe:]HARMonic:RTIME:THReshold.....	329
[SENSe:]PMETer:CONVersion:FORMat.....	316
[SENSe:]PMETer:CONVersion:MODE.....	310

[SENSe:]PMETer:CONVersion:POINts.....	310
[SENSe:]PMETer:CONVersion:RCVFrequency:CENTer.....	310
[SENSe:]PMETer:CONVersion:RCVFrequency:SPAN.....	310
[SENSe:]PMETer:CONVersion:RCVFrequency:START.....	311
[SENSe:]PMETer:CONVersion:RCVFrequency:STOP.....	311
[SENSe:]PMETer:DETEctor[:FUNction].....	306
[SENSe:]PMETer:FREQuency.....	303
[SENSe:]PMETer:MEASurement.....	316
[SENSe:]PMETer:MTIME.....	305
[SENSe:]PMETer:WAVelength.....	303
[SENSe:]ROSCillator:SOURce.....	352
[SENSe:]SWEep:COUNT.....	248
[SENSe:]SWEep:POINts.....	274
[SENSe:]SWEep:TIME.....	248
[SENSe:]SWEep:TIME:AUTO.....	249
*CLS.....	237
*ESE.....	237
*ESR?.....	237
*IDN?.....	238
*IST?.....	238
*OPC.....	238
*OPT?.....	238
*RST.....	238
*SRE.....	239
*STB?.....	239
*TRG.....	239
*TST?.....	239
*WAI.....	240
ABORT.....	247
CALCulate<t>:CALKit:CONNector.....	255
CALCulate<t>:CALKit:CUToff.....	297
CALCulate<t>:CALKit:GENDer.....	256
CALCulate<t>:CALKit:GENDer:PORT<p>.....	256
CALCulate<t>:CALKit:SELect.....	256
CALCulate<t>:CALKit:USER:OFFSet<p>:LENGth.....	297
CALCulate<t>:DELTamarker<m>:AOFF.....	280
CALCulate<t>:DELTamarker<m>:MAXimum:NEXT.....	281
CALCulate<t>:DELTamarker<m>:MAXimum[:PEAK].....	281
CALCulate<t>:DELTamarker<m>:MINimum[:PEAK].....	281
CALCulate<t>:DELTamarker<m>:X.....	282
CALCulate<t>:DELTamarker<m>:X:RELative.....	282
CALCulate<t>:DELTamarker<m>:Y?.....	282
CALCulate<t>:DELTamarker<m>[:STATe].....	280
CALCulate<t>:DTF:CABLe:LENGth.....	290
CALCulate<t>:DTF:CABLe:PRESet.....	290
CALCulate<t>:DTF:DISTance:START.....	267
CALCulate<t>:DTF:DISTance:STOP.....	267
CALCulate<t>:DTF:FREQuency:SPAN.....	266
CALCulate<t>:FILTer[:GATE]:TIME:CENTer.....	324
CALCulate<t>:FILTer[:GATE]:TIME:DCHebyshev.....	324

CALCulate<t>:FILTer[:GATE]:TIME:SHApe.....	325
CALCulate<t>:FILTer[:GATE]:TIME:SHOW.....	325
CALCulate<t>:FILTer[:GATE]:TIME:SPAN.....	326
CALCulate<t>:FILTer[:GATE]:TIME:START.....	326
CALCulate<t>:FILTer[:GATE]:TIME:STATe.....	327
CALCulate<t>:FILTer[:GATE]:TIME:STOP.....	326
CALCulate<t>:FILTer[:GATE]:TIME:WINDow.....	327
CALCulate<t>:FILTer[:GATE]:TIME[:TYPE].....	328
CALCulate<t>:MARKer:COUPled[:STATe].....	252
CALCulate<t>:MARKer:MODE.....	285
CALCulate<t>:MARKer<m>:AOFF.....	283
CALCulate<t>:MARKer<m>:FUNctIon:DTF:PEAK:RESult?	301
CALCulate<t>:MARKer<m>:FUNctIon:DTF:PEAK:THReshold.....	301
CALCulate<t>:MARKer<m>:FUNctIon:STRack[:STATe].....	284
CALCulate<t>:MARKer<m>:MAXimum:NEXT.....	284
CALCulate<t>:MARKer<m>:MAXimum[:PEAK].....	284
CALCulate<t>:MARKer<m>:MINimum[:PEAK].....	285
CALCulate<t>:MARKer<m>:X.....	286
CALCulate<t>:MARKer<m>:X:SLIMits<l>:LEFT.....	287
CALCulate<t>:MARKer<m>:X:SLIMits<l>:RIGHT.....	287
CALCulate<t>:MARKer<m>:X:SLIMits<l>[:STATe].....	286
CALCulate<t>:MARKer<m>:Y?.....	288
CALCulate<t>:MARKer<m>[:STATe].....	283
CALCulate<t>:MATH:COPIY:MEMory.....	275
CALCulate<t>:PMETer:PRESet:BANDwidth:VIDeo.....	306
CALCulate<t>:PMETer:PRESet:SElect.....	308
CALCulate<t>:PMETer:PRESet[:STATe].....	308
CALCulate<t>:PMETer:RELative[:MAGNitude].....	304
CALCulate<t>:PMETer:RELative[:MAGNitude]:AUTO.....	304
CALCulate<t>:PMETer:RELative[:MAGNitude]:OFFSet.....	304
CALCulate<t>:TRACe:CABLE:LENGth:RESult?	292
CALCulate<t>:TRACe:CABLE:LENGth[:STATe].....	292
CALCulate<t>:TRACe:CABLE:LOSS:RESult?	292
CALCulate<t>:TRACe:LIMit:VSWR:FAIL?.....	293
CALCulate<t>:TRACe:VSWR:AVG:RESult?	293
CALCulate<t>:TRACe:VSWR:MAX:RESult?	293
CALCulate<t>:TRACe:VSWR:MAX[:STATe].....	262
CALCulate<t>:TRACe:VSWR:MAX[:STATe].....	291
CALCulate<t>:TRANSform:DTFault:PEAK:COUNT?.....	301
CALCulate<t>:TRANSform:DTFault:PEAK:DATA<1...10>?.....	302
CALCulate<t>:TRANSform:DTFault:PEAK:THReshold.....	302
CALCulate<t>:TRANSform:DTFault:PEAK[:STATe].....	302
CALCulate<t>:TRANSform:TIME:CENTer.....	318
CALCulate<t>:TRANSform:TIME:LPASs.....	318
CALCulate<t>:TRANSform:TIME:LPASs:DCSParam.....	318
CALCulate<t>:TRANSform:TIME:LPASs:DCSParam:CONTInuous.....	319
CALCulate<t>:TRANSform:TIME:LPASs:DCSParam:EXTRapolate.....	320
CALCulate<t>:TRANSform:TIME:LPFRequency.....	320
CALCulate<t>:TRANSform:TIME:RESolution:EFACtor.....	320
CALCulate<t>:TRANSform:TIME:SPAN.....	320

CALCulate<t>:TRANSform:TIME:START.....	321
CALCulate<t>:TRANSform:TIME:STATe.....	321
CALCulate<t>:TRANSform:TIME:STIMulus.....	322
CALCulate<t>:TRANSform:TIME:STOP.....	321
CALCulate<t>:TRANSform:TIME:WINDow.....	322
CALCulate<t>:TRANSform:TIME:XAXis.....	323
CALCulate<t>:TRANSform:TIME[:TYPE].....	323
CALCulate<t>:VVMeter:MAGNitude:REFerence?.....	332
CALCulate<t>:VVMeter:MAGNitude:RESult?.....	332
CALCulate<t>:VVMeter:PHASe:REFerence?.....	332
CALCulate<t>:VVMeter:PHASe:RESult?.....	332
CALCulate<t>:VVMeter:REFerence[:STATe].....	333
CALCulate<t>:VVMeter:REFLection:REFerence?.....	333
CALCulate<t>:VVMeter:REFLection:RESult?.....	333
CALCulate<t>:VVMeter:VSWR:REFerence?.....	333
CALCulate<t>:VVMeter:VSWR:RESult?.....	334
CALibration:ABORT.....	297
CALibration:ATTenuation:STATus?.....	297
CALibration:CONTinue?.....	297
CALibration:MODE?.....	298
CALibration:PMETer:CONVersion:ABORT.....	314
CALibration:PMETer:CONVersion:CONTinue?.....	314
CALibration:PMETer:CONVersion:START?.....	314
CALibration:PMETer:CONVersion:STATus?.....	315
CALibration:PMETer:ZERO:AUTO.....	305
CALibration:START?.....	298
CALibration:STATus?.....	299
DISPlay[:WINDow]:STORe.....	341
DISPlay[:WINDow]:TRACe<t>:MEMory[:STATe].....	275
DISPlay[:WINDow]:TRACe<t>:MODE.....	276
DISPlay[:WINDow]:TRACe<t>:Y:SPACing.....	312
DISPlay[:WINDow]:TRACe<t>:Y[:SCALE].....	313
DISPlay[:WINDow]:TRACe<t>:Y[:SCALE]:ADJust.....	268
DISPlay[:WINDow]:TRACe<t>:Y[:SCALE]:RLEVel.....	268
DISPlay[:WINDow]:TRACe<t>:Y[:SCALE]:RPOSition.....	268
DISPlay<t>:BRIGhtness.....	347
DISPlay<t>:CMAP.....	347
DISPlay<t>:CMAP:DEFault.....	348
DISPlay<t>:DATE:FORMat.....	348
DISPlay<t>:GDELay:APERture:STEP.....	263
DISPlay<t>:GDELay:REFerence.....	241
DISPlay<t>:GDELay:REFerence:POSition.....	242
DISPlay<t>:GDELay:Y:SCALE.....	242
DISPlay<t>:IMAGinary:REFerence.....	242
DISPlay<t>:IMAGinary:REFerence:POSition.....	243
DISPlay<t>:IMAGinary:Y:SCALE.....	243
DISPlay<t>:LAYout.....	251
DISPlay<t>:LOSS:REFerence.....	269
DISPlay<t>:LOSS:REFerence:POSition.....	269
DISPlay<t>:LOSS:Y:SCALE.....	269

DISPlay<t>:MAGNitude:REFerence.....	270
DISPlay<t>:MAGNitude:REFerence:POSition.....	270
DISPlay<t>:MAGNitude:Y:SCALE.....	270
DISPlay<t>:MAGNitude:Y:SPACing.....	271
DISPlay<t>:MLINear:REFerence.....	243
DISPlay<t>:MLINear:REFerence:POSition.....	244
DISPlay<t>:MLINear:Y:SCALE.....	244
DISPlay<t>:PHASe:REFerence.....	271
DISPlay<t>:PHASe:REFerence:POSition.....	271
DISPlay<t>:PHASe:UNWRap.....	272
DISPlay<t>:PHASe:Y:SCALE.....	272
DISPlay<t>:REAL:REFerence.....	244
DISPlay<t>:REAL:REFerence:POSition.....	245
DISPlay<t>:REAL:Y:SCALE.....	245
DISPlay<t>:REFLection:UNIT.....	245
DISPlay<t>:REFLection:Y:SCALE.....	246
DISPlay<t>:VSWR:Y:SCALE.....	272
DISPlay<t>:VSWR:Y:SCALE:MAXimum.....	273
DISPlay<t>:VSWR:Y:SCALE:MINimum.....	273
FETCh<z>:PMETer?.....	307
FORMat:BORDER.....	277
FORMat[:DATA].....	276
HCOPY:DEVice:LANGuage.....	342
HCOPY[:IMMEDIATE].....	342
INITiate:CONTInuous.....	274
INITiate[:IMMEDIATE].....	248
INPut:ATTenuation<p>.....	246
INPut:IMPedance:PAD.....	352
INSTrument:NSElect.....	345
INSTrument[:SElect].....	344
MEASurement<p>:PORT.....	289
MEASurement<t>:FORMat.....	293
MEASurement<t>:FUNctIon:REFLection[:STATe].....	334
MEASurement<t>:FUNctIon:SElect.....	294
MEASurement<t>:FUNctIon:TRANSMission[:STATe].....	334
MEASurement<t>:ISUP.....	277
MEASurement<t>:ISUP:APER.....	277
MEASurement<t>:ISUP:APER:AUTO.....	277
MEASurement<t>:MODE.....	290
MMEMory:CATalog:DIRectories?.....	335
MMEMory:CATalog?.....	335
MMEMory:CDIRectory.....	336
MMEMory:COPY.....	336
MMEMory:DATA.....	336
MMEMory:DELeTe.....	337
MMEMory:FILE.....	337
MMEMory:FILE:DATE.....	337
MMEMory:FILE:TIME.....	338
MMEMory:INIT.....	338
MMEMory:LOAD:STATe.....	338



MMEMory:MDIRectory.....	339
MMEMory:MOVE.....	339
MMEMory:NAME.....	342
MMEMory:RDIRectory.....	339
MMEMory:STORe:STATe.....	339
MMEMory:STORe:TRACe.....	340
SOURce:PMETer:CONVersion:SRCFrequency:CENTer.....	311
SOURce:PMETer:CONVersion:SRCFrequency:SPAN.....	311
SOURce:PMETer:CONVersion:SRCFrequency:START.....	312
SOURce:PMETer:CONVersion:SRCFrequency:STOP.....	312
SOURce:TG:PORT.....	253
SOURce:TG:POWer.....	289
SOURce:TG:RANGe.....	289
STATus:OPERation:CONDition?.....	369
STATus:OPERation:ENABle.....	369
STATus:OPERation:NTRansition.....	369
STATus:OPERation:PTRansition.....	370
STATus:OPERation[:EVENT]?.....	369
STATus:PRESet.....	368
STATus:QUEStionable:CONDition?.....	370
STATus:QUEStionable:ENABle.....	371
STATus:QUEStionable:FREQuency:CONDition?.....	371
STATus:QUEStionable:FREQuency:ENABle.....	371
STATus:QUEStionable:FREQuency:NTRansition.....	372
STATus:QUEStionable:FREQuency:PTRansition.....	373
STATus:QUEStionable:FREQuency[:EVENT]?.....	370
STATus:QUEStionable:LIMit:CONDition?.....	371
STATus:QUEStionable:LIMit:ENABle.....	371
STATus:QUEStionable:LIMit:NTRansition.....	372
STATus:QUEStionable:LIMit:PTRansition.....	373
STATus:QUEStionable:LIMit[:EVENT]?.....	370
STATus:QUEStionable:NTRansition.....	372
STATus:QUEStionable:POWer:CONDition?.....	371
STATus:QUEStionable:POWer:ENABle.....	372
STATus:QUEStionable:POWer:NTRansition.....	373
STATus:QUEStionable:POWer:PTRansition.....	374
STATus:QUEStionable:POWer[:EVENT]?.....	370
STATus:QUEStionable:PTRansition.....	373
STATus:QUEStionable[:EVENT]?.....	370
STATus:QUEue[:NEXT]?.....	369
SYSTem:ACCessory.....	352
SYSTem:ACCessory:AUTO.....	352
SYSTem:AUDio:VOLume.....	349
SYSTem:BEEPPer:KEY:VOLume.....	349
SYSTem:BEEPPer:POVerload[:STATe].....	349
SYSTem:BEEPPer:VOLume.....	349
SYSTem:BNC:MODE.....	353
SYSTem:CAPTure:COUNter.....	343
SYSTem:CAPTure:DATaset[:STATe].....	343
SYSTem:CAPTure:MODE.....	343

SYSTem:CAPTure:SCReen[:STATe].....	344
SYSTem:COMMunicate:LAN:ETHernet.....	350
SYSTem:COMMunicate:LAN:GATeway.....	350
SYSTem:COMMunicate:LAN:SUBMask.....	350
SYSTem:COMMunicate:SOCKet:ADDResS.....	350
SYSTem:COMMunicate:SOCKet:DHCP[:STATe].....	351
SYSTem:COMMunicate:SOCKet:PORT.....	351
SYSTem:DATE.....	353
SYSTem:ERRor:ALL?.....	353
SYSTem:ERRor:CODE:ALL?.....	354
SYSTem:ERRor:CODE[:NEXT]?.....	354
SYSTem:ERRor:COUNT?.....	354
SYSTem:ERRor[:NEXT]?.....	353
SYSTem:FORMat:IDENT.....	354
SYSTem:HELP:HEADers?.....	355
SYSTem:HELP:SYNTax?.....	355
SYSTem:LANGuage.....	355
SYSTem:LANGuage:CATalog?.....	355
SYSTem:POSition:ALTitude?.....	345
SYSTem:POSition:GPS:CONNected?.....	345
SYSTem:POSition:GPS:CORRection:FREQuency?.....	346
SYSTem:POSition:GPS:QUALity?.....	346
SYSTem:POSition:GPS:SATellites?.....	346
SYSTem:POSition:GPS[:STATe].....	346
SYSTem:POSition:LATitude?.....	346
SYSTem:POSition:LONGitude?.....	347
SYSTem:POSition:VALid?.....	347
SYSTem:POWer:SOURce?.....	355
SYSTem:POWer:STATus?.....	356
SYSTem:PRESet.....	356
SYSTem:PRESet:FACTory.....	356
SYSTem:PRESet:MODE.....	356
SYSTem:PRESet:USER.....	356
SYSTem:REBoot.....	357
SYSTem:SET.....	357
SYSTem:SET:LOCK.....	341
SYSTem:SET:UNLock.....	341
SYSTem:SHUTdown.....	357
SYSTem:TIME.....	357
SYSTem:TZONee.....	358
SYSTem:VERSion?.....	358
TRACe<t>[:DATA]:MEMory?.....	279
TRACe<t>[:DATA]?.....	278
TRIGger[:SEQuence]:HOLDoff[:TIME].....	249
TRIGger[:SEQuence]:SLOPe.....	249
TRIGger[:SEQuence]:SOURce.....	250
UNIT<t>:LENGth.....	278
UNIT<t>:PMETer:POWer.....	307
UNIT<t>:POWer.....	246

# Index

## A

AC adapter .....	19
Accessory detection .....	40
Analyzing measurement .....	140
Using display and limit lines .....	140
Using markers .....	140
Working with traces .....	140
Analyzing measurement results	
Using display lines .....	188
Using limit lines .....	188
Using markers .....	187
Working with traces .....	186
Antenna	
Configuring .....	40
Application cards .....	13
Application notes .....	13
Attenuation .....	201
Audio settings .....	48
Auto power up .....	49
Average time .....	197

## B

Backlight .....	46
Basic instrument operation .....	31
Battery insertion .....	18
Battery low level .....	49
Battery maintenance .....	22
Battery operation	
Battery (car adapter) .....	20
Battery (charging) .....	20
Battery (external charger) .....	20
Battery (replacement) .....	20
Beeper .....	151
BNC connector	
Configuring .....	40
Brochure .....	12

## C

Cable & Antenna	
CAL .....	401
FORMAT .....	398
FREQ/DIST .....	396
LINE .....	399
MARKER .....	400
SCALE .....	397
SWEEP .....	398
TRACE .....	398
Cable and antenna test mode .....	107
Calibrating measurements .....	124
Calibration kit .....	128
Calibration methods .....	125, 156
Calibration states .....	125, 155
Performing a full 1-Port calibration .....	128
Performing a full 2-Port calibration .....	128
Performing calibration .....	157
Calibration certificate .....	12
Calibration kit model .....	50
Center frequency .....	195, 200
Clear status	
Remote .....	237

Command sequence	
Remote .....	240
Command sequence and command synchronization .....	235
Configuring cable and antenna tests .....	129
Configuring the horizontal axis .....	132
Configuring the tracking generator .....	138
Configuring the vertical axis .....	136
Selecting the cable mode .....	129
Setting and triggering the sweep .....	139
Setting the measurement bandwidth .....	138
Configuring the instrument	
Audio settings .....	348
Controlling the GPS receiver .....	345
Display configuration .....	347
Mode selection .....	344
Setting up a network connection .....	350
System settings .....	351
Configuring vector network analysis	
Configuring the vertical axis .....	179
Configuring vector network analysis .....	179
Selecting the measurement format .....	181
Setting the sweep parameters .....	183
Customer support .....	411

## D

Data management .....	87
Data sheet .....	12
Date & time .....	43
Date format .....	44
Default values	
Remote .....	238
Delete dataset .....	93
Delta marker .....	144
Device documentation .....	94
Directional power sensor .....	198
Zeroing .....	69
Display element .....	31
Display line .....	148
Display settings .....	46
Distance to fault measurements	
Split screen .....	111
Documentation overview .....	11

## E

Electrostatic discharge .....	16
ESD .....	16
Event status enable register (ESE)	
Remote .....	237
Event status register (ESR)	
Remote .....	237
Export dataset .....	94

## F

File management .....	87
Firmware .....	94
Forward power display .....	198
Frequency	
settings .....	195, 200
Front panel keys .....	78
Function keys .....	79

**G**

Getting started .....	12
GPS receiver .....	41

**H**

Hardkey	
WIZARD .....	393
Hardware settings .....	40

**I**

Identification	
Remote .....	238
Instrument model and command processing .....	223
Instrument tour .....	24
Intended use .....	11
Interfaces and protocols .....	219
LAN .....	219
SCPI .....	219
USB .....	219
VISA .....	219
VXI-11 .....	219
IST flag	
Remote .....	238

**K**

Key	
Meas (PM) .....	198
MEAS (PM) .....	193, 203
MODE .....	382
SAVE/RECALL .....	381
SETUP .....	375
Keypad .....	81

**L**

LAN connection with R&S ZNH .....	53
Languages .....	44
Length unit .....	44
Limit check .....	151
Limit line .....	150
Loss parameters	
Definition .....	160

**M**

Marker	
Automatic positioning .....	145
Delta marker .....	144
Removal .....	146
Search limit .....	148
Search limits .....	146
Selection .....	145
Type .....	145
Measurement	
Directional power sensor .....	198
Measurement setup	
Configure overview .....	84
Measurement wizard .....	96
Evaluating results .....	105
Performing and configuring measurements .....	96
Measuring transmissions .....	62
Reflection measurement .....	65
Transmission measurement .....	64

Menu .....	375
General .....	375
Menu and softkey overview .....	375
Mixed mode measurements .....	168
Mixer measurement .....	211

**N**

Navigation controls	
Rotary knob .....	82

**O**

Offset parameters	
Application .....	162
Balanced ports .....	163
Definition .....	159
On-screen keyboard .....	77
Open source acknowledgment (OSA) .....	13
Operation complete	
Remote .....	238
Options .....	59, 94
Checking options .....	60
Enabling options .....	59
Identification (remote) .....	238
Managing options with R&S license manager .....	61

**P**

Package contents .....	18
Perform vector network analysis measurements	
Mixed mode measurements .....	168
Ratios measurements .....	167
S-Parameter measurements .....	164
Time domain analysis .....	170
Wave measurements .....	165
Performing cable and antenna measurements .....	109
1-Port cable loss measurement .....	113
Distance to fault .....	118
Phase measurement .....	123
Reflection measurements .....	110
Smith chart .....	121
Transmission measurements .....	114
Waveguide measurement .....	116
Positioning	
Support .....	18
Power key .....	78
Power meter .....	193, 203, 211
CAL .....	392
FORMAT .....	388
FREQ .....	387
LINE .....	390
MARKER .....	391
MEAS .....	383
SCALE .....	389
SWEEP .....	390
TRACE .....	391
Power overload beep .....	49
Power sensor .....	193, 194, 195, 203, 211
Attenuation .....	201
Average time .....	197
Directional .....	198
errors .....	195
Reference level .....	197
Standard .....	201
Unit .....	197, 200

Weighting mode .....	200
Zeroing .....	66, 196
Power settings .....	49
Power vs frequency .....	212
Preset .....	51, 83
Preview dataset .....	92
Pulse characteristic .....	205
Pulse power measurement .....	203
Power vs time .....	203
Putting into operation .....	16

## R

R&S InstrumentView	
Limit lines .....	149
Ratios measurements .....	167
Reference level	
Directional power meter .....	200
Power sensor .....	197
Regional settings .....	44
Release notes .....	13
Remote commands	
Cable and antenna analyzer .....	263
Common commands .....	236
Configuring data capture .....	342
Configuring the instrument .....	344
File management .....	335
Frequency conversion power measurement .....	309
Making and storing screenshots .....	341
Power meter .....	303
Status reporting system .....	367
Time domain analysis .....	317
Vector network analyzer .....	240
Vector voltmeter .....	330
Remote control commands .....	235
Remote control connection .....	222
Changing the IP address .....	222
Reset .....	51
Reset values	
Remote .....	238
Restore dataset .....	91

## S

S-Parameter measurements .....	164
Safety information .....	11
Safety instructions .....	12
Save on event .....	89
SCPI command structure and syntax .....	226
Screen layout	
Configuration overview .....	37
Configure overview .....	31
Measurement result view .....	33
Measurement trace window .....	33
Parameter view .....	36
Power meter .....	193
Power meter (Directional) .....	198
Power meter (Pulse) .....	203
Power vs frequency .....	211
Title bar .....	32
Trace label .....	32
Vector network analyzer .....	31
Screenshot .....	85
Dataset .....	85
Preview .....	85
Screenshot key .....	78
Search limits .....	146

Self-test	
Remote .....	239
Service request enable register (SRE)	
Remote .....	239
Softkey .....	78
Cable & Antenna .....	395
General .....	375
Power meter .....	383
Vector network analyzer .....	401
Vector voltmeter .....	409
Standard	
Directional power sensor .....	201
Power sensor .....	201
Status byte	
Remote .....	237, 239
Status reporting system .....	358
Application of the status reporting systems .....	365
Event status register (ESR) and event status enable register (ESE) .....	362
Overview of the status register .....	360
Reset values of the status reporting system .....	367
Status byte (STB) & service request enable register (SRE) .....	361
Structure of a SCPI status register .....	359
Switching on and off the instrument .....	23
Synchronization	
Data .....	87
System keys .....	78

## T

Time domain analysis .....	170
Band pass and low pass mode .....	171
Harmonics grid .....	174
Time gates .....	177
Windows in the frequency domain .....	173
Time domain reflectometry (TDR) .....	120
Touchscreen gesture	
Add marker .....	72
Change center frequency .....	72
Change reference level .....	72
Change span .....	72
Delete all markers .....	72
Trigger	
Event (remote) .....	239

## U

Unit	
Power sensor .....	197, 200
Unpacking and checking the instrument .....	17
USB connection with R&S ZNH .....	58
User interface .....	31
User manual .....	12
Using markers and deltamarkers .....	142

## V

Vector network analysis .....	153
Analyzing measurement results .....	185
Calibrating measurements .....	154
Configuring vector network analysis .....	179
Offset parameters .....	159
Perform vector network analysis measurements .....	163
Vector network analyzer	
CAL .....	407
FORMAT .....	404

FREQ/DIST .....	403
LINE .....	406
MARKER .....	406
SCALE .....	403
SWEEP .....	404
TRACE .....	405
Vector voltmeter .....	190
Analyzing measurement results .....	192
CAL .....	410
Calibrating measurements .....	191
FREQ/DIST .....	409
Performing voltmeter measurements .....	191
SCALE .....	409
SWEEP .....	409
TRACE .....	410
Volume	
Key clock volume .....	48
System beeper .....	48
<b>W</b>	
Wait	
Remote .....	240
Wave measurements .....	165
Waveguide measurement	
Calibrating waveguide measurement .....	117
Configuring waveguide measurement .....	118
Wavelength .....	195
settings .....	195
White papers .....	13
WIZARD .....	393
Working directory .....	84
<b>Z</b>	
Zeroing .....	196