

# R&S® RT-ZC20 Current Probe User Manual



1409781402

Version 04

**ROHDE & SCHWARZ**

Make ideas real



This manual describes the following R&S products:

- R&S®RT-ZC20, Current Probe (1409.7766.02)
- R&S®RT-ZA13, Probe Power Supply (1409.7789.02)

© 2023 Rohde & Schwarz GmbH & Co. KG  
Muehldorfstr. 15, 81671 Muenchen, Germany  
Phone: +49 89 41 29 - 0  
Email: [info@rohde-schwarz.com](mailto:info@rohde-schwarz.com)  
Internet: [www.rohde-schwarz.com](http://www.rohde-schwarz.com)

Subject to change – data without tolerance limits is not binding.

R&S® is a registered trademark of Rohde & Schwarz GmbH & Co. KG.

Trade names are trademarks of the owners.

1409.7814.02 | Version 04 | R&S®RT-ZC20

The following abbreviations are used in this manual: R&S®RT-ZC20 is abbreviated as R&S RT-ZC20, and R&S®RT-ZA13 is abbreviated as R&S RT-ZA13.

# Contents

<b>1 Safety and regulatory information.....</b>	<b>5</b>
1.1 Safety instructions.....	5
1.2 Labels on the product.....	7
1.3 Warning messages in the documentation.....	8
<b>2 Product description.....</b>	<b>9</b>
2.1 Key features.....	9
2.2 Unpacking and checking.....	9
2.3 Description of the probe.....	10
<b>3 Connecting the probe.....</b>	<b>13</b>
3.1 Handling the probe.....	13
3.2 Connecting the probe to the power supply.....	14
3.3 Connecting the probe to the oscilloscope.....	15
3.4 Setting up and demagnetizing.....	16
3.5 Connecting the probe to the DUT.....	17
3.6 Considerations for measurements.....	19
<b>4 Maintenance and service.....</b>	<b>22</b>
4.1 Cleaning.....	22
4.2 Contacting customer support.....	22
4.3 Returning for servicing.....	23
4.4 Calibration interval.....	23
4.5 Storage and transport.....	24
4.6 Disposal.....	24
<b>5 R&amp;S RT-ZA13 probe power supply.....</b>	<b>25</b>



# 1 Safety and regulatory information

The product documentation helps you to use the product safely and efficiently. Follow the instructions provided here and in the [Chapter 1.1, "Safety instructions"](#), on page 5.

## Intended use

The product is intended for the development, production and verification of electronic components and devices in industrial, administrative, and laboratory environments. Use the product only for its designated purpose. Observe the operating conditions and performance limits stated in the data sheet.

## Where do I find safety information?

Safety information is part of the product documentation. It warns you of potential dangers and gives instructions on how to prevent personal injury or damage caused by dangerous situations. Safety information is provided as follows:

- In [Chapter 1.1, "Safety instructions"](#), on page 5. The same information is provided in many languages as printed "Safety Instructions". The printed "Safety Instructions" are delivered with the product.
- Throughout the documentation, safety instructions are provided when you need to take care during setup or operation.

## 1.1 Safety instructions

Products from the Rohde & Schwarz group of companies are manufactured according to the highest technical standards. To use the products safely, follow the instructions provided here and in the product documentation. Keep the product documentation nearby and offer it to other users.

Use the product only for its intended use and within its performance limits. Intended use and limits are described in the product documentation such as the data sheet, manuals and the printed "Safety Instructions". If you are unsure about the appropriate use, contact Rohde & Schwarz customer service.

Using the product requires specialists or specially trained personnel. These users also need sound knowledge of at least one of the languages in which the user interfaces and the product documentation are available.

Reconfigure or adjust the product only as described in the product documentation or the data sheet. Any other modifications can affect safety and are not permitted.

Never open the casing of the product. Only service personnel authorized by Rohde & Schwarz are allowed to repair the product. If any part of the product is damaged or broken, stop using the product. Contact Rohde & Schwarz customer service at <https://www.rohde-schwarz.com/support>.

In these safety instructions, the term "product" covers instruments (oscilloscopes), probes and their accessories.

### Choosing the operating site

Only use the product indoors. The product casing is not waterproof. Water that enters can electrically connect the casing with live parts, which can lead to electric shock, serious personal injury or death if you touch the casing. If Rohde & Schwarz provides accessories designed for outdoor use of your product, e.g. a protective cover, you can use the product outdoors.

Unless otherwise specified in the data sheet, you can operate the product up to an altitude of 2000 m above sea level.

The product is suitable for pollution degree 2 environments where nonconductive contamination can occur. For more information on environmental conditions such as ambient temperature and humidity, see the data sheet.

### Performing measurements

Take the following measures for your safety:

- Observe all voltage and current ratings of the instrument, the probes, and the accessories. Exceeding the allowed limits can lead to an electric shock. Limits and ratings are marked on the products and listed in the data sheets. Consider that the rated values depend on the frequency. The limitation curves or values are provided in the data sheet.
- Never cause any short circuits when measuring sources with high output currents.
- When working with current probes, observe the additional operating conditions specified in these safety instructions.
- Prevent the probe from receiving mechanical shock. Avoid putting excessive strain on the probe cable or exposing it to sharp bends. Touching a broken cable during measurements can cause injuries.
- Set up all probe connections to the instrument before applying power.

## Working with current probes

When working with current probes, you can measure high-frequency currents or currents that contain high-frequency components.



- Switch off the test circuit while connecting the probe.
- Do not attach the clamp to bare unisolated conductors. To avoid injury from a short circuit, measure at a location on an insulated wire where the insulation is sufficient for the circuit voltage.
- Connect the probe only to the secondary side of a breaker. With this measure, you avoid injury, if a short circuit occurs.
- The following effects can cause burns and fire or damage to the measurement site:
  - Eddy current loss can cause heating of the sensor head.
  - Dielectric heating can cause heating of cord insulation and other materials.
- When measuring current that includes a high-frequency component, consider the derating characteristics of the probe. Do not measure any current that exceeds the rated current.
- Using the probes with high frequencies or strong magnetic fields may cause the device to become abnormally hot, resulting in fire, equipment damage, or burns.

## 1.2 Labels on the product

Labels on the casing inform about:

- Personal safety
- Product and environment safety
- Identification of the product

**Table 1-1: Meaning of safety labels**

	<p>Potential hazard Read the product documentation to avoid personal injury or product damage.</p>
	<p>Hazardous contact voltages Do not use the probe at uninsulated live lines. Make sure to measure at sufficiently insulated conductors. This measure protects you against electric shock, electric burn, or arc flash.</p>

**Table 1-2: Labels regarding product and environment safety**

	Labeling in line with EN 50419 for disposal of electrical and electronic equipment after the product has come to the end of its service life.
---	---

## 1.3 Warning messages in the documentation

A warning message points out a risk or danger that you need to be aware of. The signal word indicates the severity of the safety hazard and how likely it will occur if you do not follow the safety precautions.

### **WARNING**

Potentially hazardous situation. Could result in death or serious injury if not avoided.

### **CAUTION**

Potentially hazardous situation. Could result in minor or moderate injury if not avoided.

### **NOTICE**

Potential risks of damage. Could result in damage to the supported product or to other property.



## 2 Product description

The R&S RT-ZC20 is an AC/DC current probe. It allows the user to make current measurements from DC to 100 MHz. By clamping on the conductor to be measured, the current waveform is captured easily without interrupting the electric circuit.

### 2.1 Key features

The R&S RT-ZC20 is an AC/DC current probe. It allows the user to make current measurements from DC to 100 MHz. By clamping on the conductor to be measured, the current waveform is captured easily without interrupting the electric circuit.

The key features of the probe are the following:

- Highly accurate current detection.
- Easy current measurement without interrupting the electric circuit.
- Broadband frequency characteristics DC to 100 MHz.
- Permits measurement of low current levels.
- Easy protection function to avoid self-heating during excessive input.
- Unique thin film Hall effect element.

### 2.2 Unpacking and checking

1. Unpack the product carefully.
2. Retain the original packing material. Use it when transporting or shipping the product later.
3. Using the delivery notes, check the equipment for completeness.
4. Check the equipment for damage.

If the delivery is incomplete or equipment is damaged, contact Rohde & Schwarz.

## Delivery notes

The delivery contains the following items:

- User manual
- Carrying case
- R&S RT-Zxx high-voltage and current probes data sheet
- Safety instructions for oscilloscopes and accessories (multilingual)
- Calibration certificate
- Documentation of calibrated values

## 2.3 Description of the probe

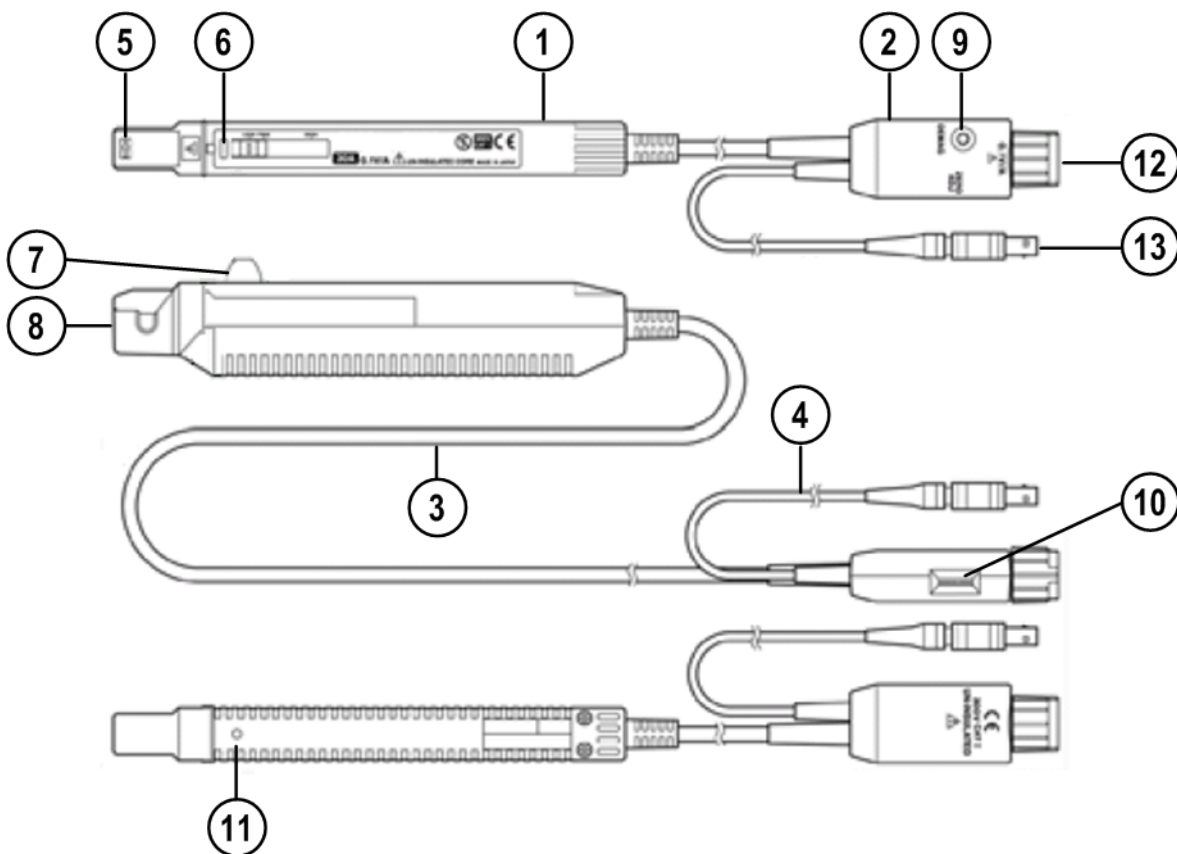

- 1 = Sensor
- 2 = Terminator
- 3 = Sensor cable
- 4 = Power supply cable
- 5 = Current direction indication
- 6 = UNLOCK indication

- 7 = Opening lever
- 8 = Sensor head
- 9 = Demagnetizing switch (DEMAG)
- 10 = Zero adjustment dial (ZERO ADJ)
- 11 = Coarse adjustment trimmer
- 12 = Output connector
- 13 = Power plug

### Sensor head

The sensor head clamps on the conductor being measured, and carries out the actual current measurement. It is a precision assembly including a molded component, a ferrite core, and a Hall effect element. It may be damaged if subjected to sudden changes in ambient temperature, or mechanical strain or shock, and therefore great care should be exercised in handling it.

See also "[Handling the sensor head](#)" on page 13.

### Opening lever

Operating lever for opening the sensor head. Always use this lever to open the sensor head.

### Demagnetizing switch (DEMAG)

This demagnetizes the core if it has been magnetized by switching the power on and off, or by an excessive input. Always carry out demagnetizing before measurement.

### Zero adjustment dial (ZERO ADJ)

Use the zero adjustment dial to correct for the effect of a voltage offset or temperature drift.

When beginning measurement, after demagnetizing always carry out a zero adjustment.

### Coarse adjustment trimmer

Use this only when adjustment is not possible within the range of the zero adjustment. Use a nonconductive screwdriver (e.g. ceramic driver) for adjustment.

### Output connector

Connect to the BNC input connector of the waveform measuring instrument.

The current waveform of the measured conductor is output at a constant rate (0.1 V/A).

**Power plug**

Connect the plug to the R&S RT-ZA13 probe power supply receptacle to supply power to the sensor.

## 3 Connecting the probe

### 3.1 Handling the probe

The R&S RT-ZC20 can withstand a moderate amount of physical and electrical stress. To avoid damage, treat the probe with care:

- Prevent the probe from receiving mechanical shock.
- This device should be installed and operated indoors only, between 0°C and 40°C (32°F to 104°F) and 80% RH or less.
- Avoid strain on the probe cable and route it carefully. Keep the cable away from heat sources, as bare conductors could be exposed if the insulation melts.
- Do not spill liquids on the probe.

#### Handling the sensor head

The sensor head is a precision assembly including a molded component, a ferrite core, and a Hall effect element. To avoid damage, treat it with care:

- Do not subject it to sudden changes in ambient temperature.
- If the mating surfaces are scratched, performance may be impaired. Prevent the mating surfaces of the sensor head from being scratched:
  - Keep the sensor head closed when not in use, to avoid accumulating dust or dirt.
  - Measurements are degraded by dirt on the mating surfaces of the sensor head, so keep the surfaces clean by gently wiping with a soft cloth.
  - Keep the clamp jaws and core slits free from foreign objects, which could interfere with clamping action.
  - When the power is on, keep the core section of the sensor closed, except when clamping it onto the conductor to be measured. The mating surface of the core section can be scratched while it is open.

#### Electromagnetic compatibility

The electromagnetic compatibility (EMC) class indicates where you can operate the product. The product is rated in EMC class B, see also data sheet under "General data".

## Connecting the probe to the power supply

Class B equipment is suitable for use in:

- Residential environments
- Environments that are directly connected to a low-voltage supply network that supplies residential buildings

## 3.2 Connecting the probe to the power supply

1. Have the R&S RT-ZA13 probe power supply, and an oscilloscope or waveform measuring instrument ready.
2. **NOTICE!** Voltage check. When using a different power supply than the R&S RT-ZA13 probe power supply, before turning on the power, make sure that the voltage of the used power supply matches the supply voltage indicated in the data sheet "R&S RT-Zxx high voltage and current probes".  
Turn off the power switch at the rear of the R&S RT-ZA13 probe power supply.
3. Connect the power cord.
4. Connect the power plug of the R&S RT-ZC20 to the power receptacle of the R&S RT-ZA13 probe power supply.

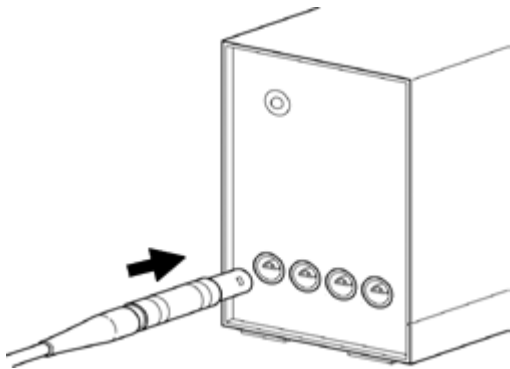

5. Check that the conductor being measured is not clamped when supplying power to the R&S RT-ZC20. When power is turned on, a demagnetizing waveform is initially applied to the output. This is intentional in the design, and not a fault.
6. Turn on the power switch of R&S RT-ZA13 probe power supply. Ensure that the front panel power indicator lights.

## Connecting the probe to the oscilloscope

7. Connect the R&S RT-ZC20 to the oscilloscope, as described in [Chapter 3.3, "Connecting the probe to the oscilloscope"](#), on page 15.

### 3.3 Connecting the probe to the oscilloscope

-  The output of this device is terminated internally. Use a high impedance input of the measuring instrument. With an input impedance of  $50\ \Omega$ , accurate measurement is not possible.
- If using BNC-banana plug adapters or similar to connect to input terminals other than BNC connectors, make sure the polarity is correct.

**To connect the probe:**

1. Insert the output connector of the R&S RT-ZC20 into one of the BNC input connectors of the oscilloscope.
2. Turn the collar until it clicks.
3. Ensure that the collar is locked securely.

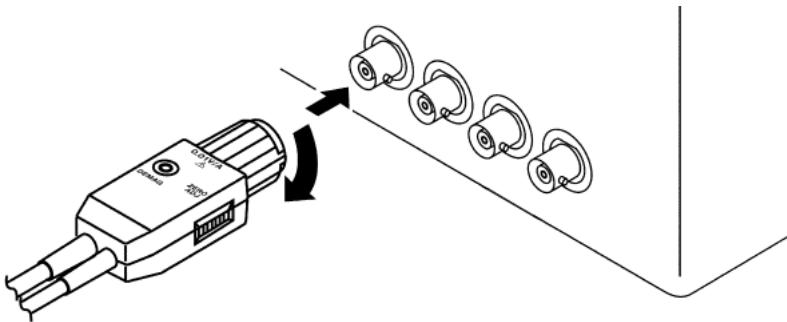

**Figure 3-1: Connecting the probe to the Rohde & Schwarz oscilloscope**

4. Configure the probe connection at the oscilloscope. The exact procedure depends on the used instrument and is described in the oscilloscope's user manual. Supported oscilloscopes are listed in the R&S RT-Zxx data sheet.

Make sure to set the following:

- Vertical unit = Ampere
- Coupling = DC
- Termination =  $1\ \text{M}\Omega$

- Manual Gain = 0.1 V/A

Alternatively, select "Predefined probe" = R&S RT-ZC20 if this selection is available on the instrument.

#### To disconnect the probe:

1. Turn the collar until it is unlocked.
2. Pull the connector away from the oscilloscope.

### 3.4 Setting up and demagnetizing

1. With the waveform measuring instrument input at ground, adjust the waveform to the zero position.
2. Connect the R&S RT-ZC20 current probe to the power supply as described in [Chapter 3.2, "Connecting the probe to the power supply"](#), on page 14.
3. Connect the R&S RT-ZC20 current probe to the oscilloscope as described in [Chapter 3.3, "Connecting the probe to the oscilloscope"](#), on page 15.
4. **NOTICE!** Risk of circuit damage. Demagnetizing causes current to flow into the conductor, which may damage parts in the circuit to be measured. Do not demagnetize while the R&S RT-ZC20 is clamping a conductor to be measured.

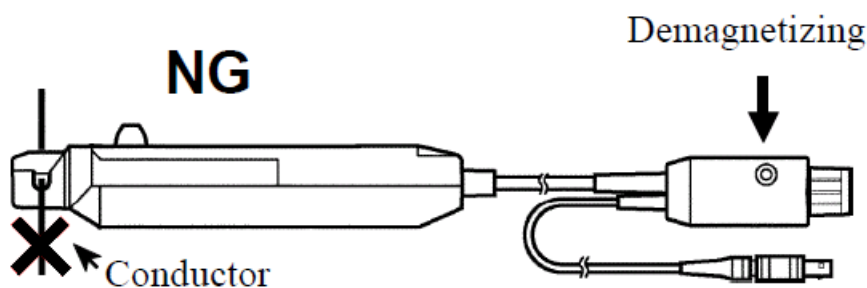

Make sure that there is no conductor in the sensor aperture.

5. Press the opening lever until the UNLOCK indication disappears. Ensure that the sensor head is properly closed.
6. Press the demagnetizing switch (DEMAG) on the terminator.



## Connecting the probe to the DUT

The demagnetizing process takes about one second. During demagnetizing, a demagnetizing waveform is shown on the oscilloscope. The positive and negative components of this waveform may be asymmetrical.

7. Turn the zero adjustment dial on the terminator to adjust the trace to the zero position.
8. If zero adjustment is not possible, turn the coarse adjustment trimmer to bring the trace within the range of adjustment by the zero adjustment dial, see [Chapter 2.3, "Description of the probe"](#), on page 10.

**Note:** Use the trimmer carefully to prevent damaging it. Use a flathead screwdriver that is made of non-conductive material like ceramics. Recommended tip shape: thickness 4 mm, width 1.8 mm, length 10 mm or longer.

### 3.5 Connecting the probe to the DUT

1. Check that the system is safe, and that the preparations described in the preceding sections have been carried out.
2. Pull the sensor slider, so that the clamp opens.

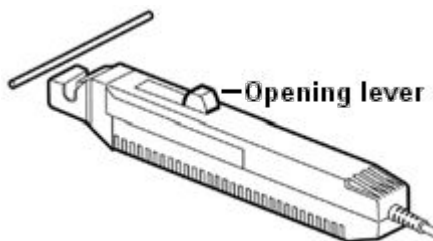

3. Align the sensor so that the current direction indication matches the direction of current flow through the conductor that you measure. The conductor should be in the center of the clamp aperture because the measurement may be affected by the position within the clamp aperture of the conductor being measured.
4. Press the opening lever until the UNLOCK indication disappears. Make sure that the sensor head is properly closed.

## Connecting the probe to the DUT

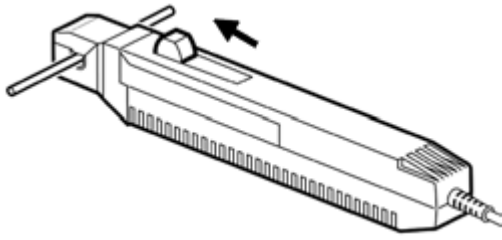

If the sensor head is not properly closed, accurate measurement is not possible.

The current consumption of clamp-on probes depends on the current to be measured. Confirm that the total current consumption of the probes does not exceed the rated output current of the R&S RT-ZA13 probe power supply.

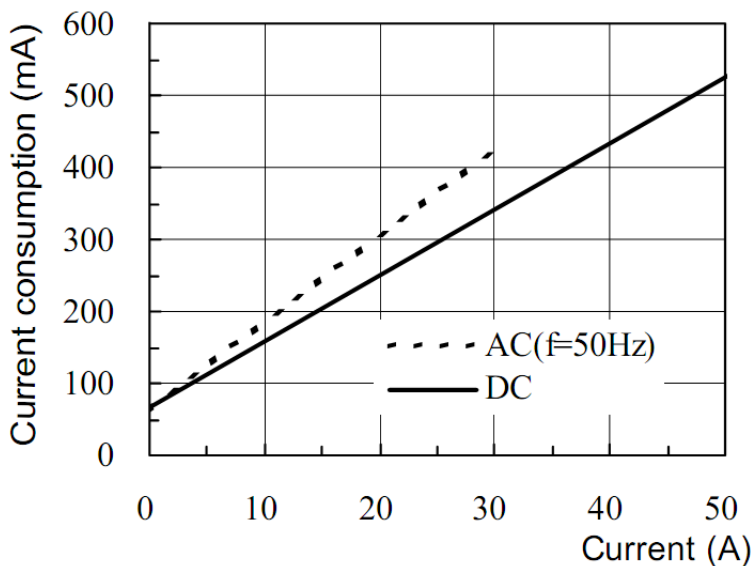

**Figure 3-2: Current consumption\* vs. current to be measured (typical)**

\*The sum total of positive and negative current consumption.

## 3.6 Considerations for measurements

### Measurements of continuous input current

To avoid damage to the probe when doing measurements of continuous input current, consider the following:

- The maximum continuous input range is based on heat that is internally generated during measurement. It varies according to the frequency of the current being measured. Refer to the data sheet "R&S RT-Zxx high voltage and current probes".
- The device may sustain damage from self-heating even at current levels that are lower than the maximum rated current. The maximum rated current is a recommended value that assumes sine-wave input under standard conditions. Self-heating may happen if the ambient temperature increases or the measurement current waveform contains other frequency components.
- If the input current exceeds a certain level, generated heat activates a built-in safety function that blocks normal output. If this happens, remove the input immediately (remove the sensor from the conductor being measured, or reduce the input current to zero). Wait until the sensor has had sufficient time to cool before resuming operation.  
Continuous input of current exceeding the rated maximum or repeated activation of the safety function may result in damage to the device.
- Even if the input current does not exceed the rated continuous maximum current, continuous input for an extended period of time may result in activation of the safety circuit to prevent damage resulting from heating of the sensor. At high ambient temperatures, the built-in safety circuit may activate at current input levels below the rated continuous maximum current.
- Current measurement exceeding approx. 1 kHz may result in temperature rise on the sensor-head. This is attributed to excitation loss that cannot be prevented due to natural physical principles. Be careful to avoid injury, electric shock due to short-circuits, or damage to the device that may be caused by the increased temperature.
- Do not place any unclamped conductor with an electric current of a frequency of 10 kHz or more near the sensor head. Current flowing in the conductor nearby may heat up the sensor head and cause its temperature to rise, leading to damage to the sensor. For example, when one side of a go-and-return conductor is clamped and the other side is also placed near the sensor head as shown in the diagram, even if the electric current is lower than the consec-

## Considerations for measurements

utive maximum current, electric currents in both sides will heat up the sensor and raise the temperature, thereby causing damage to the sensor.

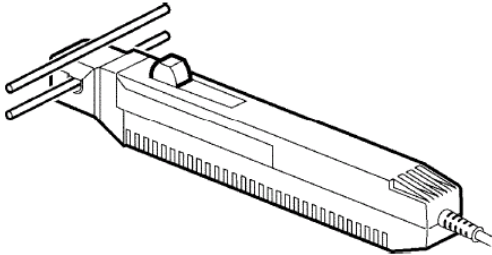
**Drift, oscillation, and sound**

- Immediately after powering on, the probe may be subject to an appreciable offset drift due to the effect of self-heating. Therefore, warm up the probe for about 30 minutes before carrying out measurements.
- When performing continuous measurements, be aware that the offset voltage drifts, depending on factors such as the ambient temperature.
- Under certain circumstances, oscillation may occur while the power supply is on. This does not indicate a malfunction. Oscillation can be stopped and operation restored to normal by opening and closing the sensor head.
- Acoustic resonance can occur depending on the amplitude and frequency of the measured current. This sound may also occur during demagnetizing operation, but it is not a malfunction or probe failure.

If a foreign substance such as dust is present on the contact surfaces of the sensor head, a slight gap can occur between the upper and lower sensors, and a resonant sound may be emitted. Clean the sensors as described in this manual to ensure correct measurements.

- An increasing volume of the resonant sound during use may indicate that the gap between the upper and lower sensors has increased. Since the sensor characteristics may change, it is recommended to calibrate the device.

## Considerations for measurements

- i** At high frequencies, common mode noise may affect measurements taken on the high-voltage side of circuits. If this occurs, reduce the frequency range of the waveform measuring instrument, or clamp onto the low-voltage side of the circuit, as appropriate.

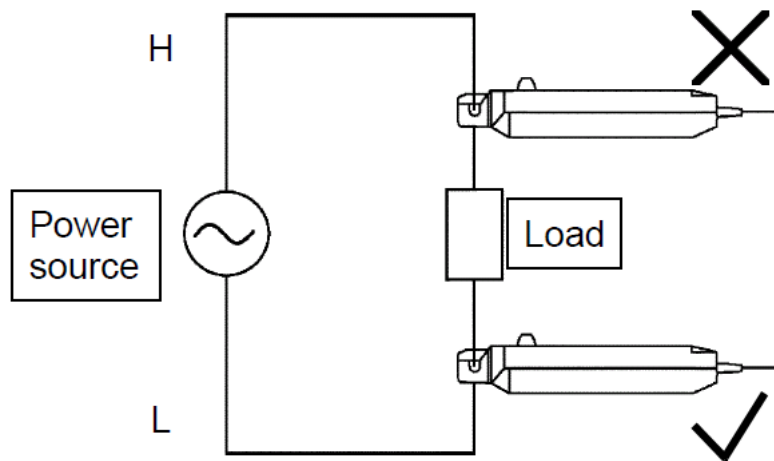

## 4 Maintenance and service

If service or calibration is needed, contact your Rohde & Schwarz service center. Return a defective product to the Rohde & Schwarz service center for diagnosis and exchange.

### 4.1 Cleaning

1. Discharge any static electricity at your hands before cleaning the facing surfaces of the sensor head.

Thus, you ensure that no high voltage caused by static electricity is applied to the product. Application of a high voltage can damage the internal Hall elements or circuitry. You can attract static electricity to your hands by touching a nearby metal object.

2. Clean the outside of the product using a soft cloth moistened with either distilled water or isopropyl alcohol. Keep in mind that the casing is not waterproof.

**Note:** Do not use cleaning agents. Solvents (thinners, acetone), acids and bases can damage the labeling or plastic parts.

3. Dry the product completely before using it.

### 4.2 Contacting customer support

#### Technical support – where and when you need it

For quick, expert help with any Rohde & Schwarz product, contact our customer support center. A team of highly qualified engineers provides support and works with you to find a solution to your query on any aspect of the operation, programming or applications of Rohde & Schwarz products.

#### Contact information

Contact our customer support center at [www.rohde-schwarz.com/support](http://www.rohde-schwarz.com/support), or follow this QR code:



Figure 4-1: QR code to the Rohde & Schwarz support page

### 4.3 Returning for servicing

Use the original packaging to return your R&S RT-ZC20 to your Rohde & Schwarz service center. A list of all service centers is available on:

[www.services.rohde-schwarz.com](http://www.services.rohde-schwarz.com)

If you cannot use the original packaging, consider the following:

1. Use a sufficiently sized box.
2. Protect the product from damage and moisture (e.g. with bubble wrap).
3. Use some kind of protective material (e.g. crumpled newspaper) to stabilize the product inside the box.
4. Seal the box with tape.
5. Address the package to your nearest Rohde & Schwarz service center.

### 4.4 Calibration interval

The recommended calibration interval for R&S RT-ZC20 current probe is one year. For servicing, send the probe to your nearest Rohde & Schwarz service center (see [Chapter 4.3, "Returning for servicing"](#), on page 23).

## 4.5 Storage and transport

Protect the product against dust. Ensure that the environmental conditions, e.g. temperature range and climatic load, meet the values specified in the data sheet.

Store the product in a shock-resistant case, e.g. in the shipping case.

Unless otherwise specified in the data sheet, the maximum transport altitude without pressure compensation is 4500 m above sea level.

## 4.6 Disposal

Rohde & Schwarz is committed to making careful, ecologically sound use of natural resources and minimizing the environmental footprint of our products. Help us by disposing of waste in a way that causes minimum environmental impact.

### Disposing electrical and electronic equipment

A product that is labeled as follows cannot be disposed of in normal household waste after it has come to the end of its service life. Even disposal via the municipal collection points for waste electrical and electronic equipment is not permitted.



**Figure 4-2: Labeling in line with EU directive WEEE**

Rohde & Schwarz has developed a disposal concept for the eco-friendly disposal or recycling of waste material. As a manufacturer, Rohde & Schwarz completely fulfills its obligation to take back and dispose of electrical and electronic waste. Contact your local service representative to dispose of the product.



## 5 R&S RT-ZA13 probe power supply

This unit is a special-purpose power supply for the current probes.

You can connect up to four current probes to the power supply.

### Front view

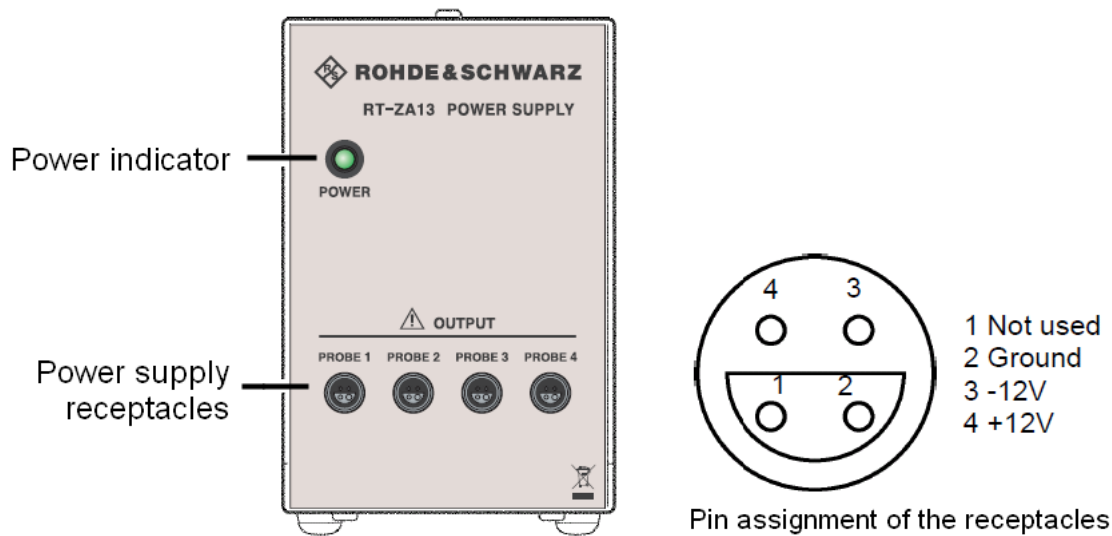

### Rear view

