

R&S® RT-ZPR20 R&S® RT-ZPR40 Power-Rail Probe User Manual



1800503502

Version 04

ROHDE & SCHWARZ

Make ideas real



This manual describes the following R&S®RT-ZPR models:

- R&S®RT-ZPR20 (1800.5006.02)
- R&S®RT-ZPR40 (1800.5406.02)

© 2022 Rohde & Schwarz GmbH & Co. KG
Muehldorfstr. 15, 81671 Muenchen, Germany
Phone: +49 89 41 29 - 0
Email: info@rohde-schwarz.com
Internet: www.rohde-schwarz.com

Subject to change – data without tolerance limits is not binding.

R&S® is a registered trademark of Rohde & Schwarz GmbH & Co. KG.

All other trademarks are the properties of their respective owners.

1800.5035.02 | Version 04 | R&S®RT-ZPR20 R&S®RT-ZPR40

Throughout this manual, products from Rohde & Schwarz are indicated without the ® symbol and without product type numbers, e.g. R&S®RT-ZPR20/40 is indicated as R&S RT-ZPR20/40, and R&S®ProbeMeter is indicated as R&S ProbeMeter.

Contents

1 Safety and regulatory information.....	5
1.1 Safety instructions.....	5
1.2 Labels on the product.....	7
1.3 Warning messages in the documentation.....	7
2 Product description.....	9
2.1 Key characteristics and key features.....	9
2.2 Unpacking and checking.....	10
2.3 Description of the probe.....	10
2.4 Probe box.....	11
2.5 Accessories and items.....	11
3 Connecting the probe.....	16
3.1 Handling the probe.....	16
3.2 Connecting the probe to the oscilloscope.....	16
3.3 Identification of the probe.....	18
3.4 Connecting the probe to the DUT.....	18
4 Features and characteristics.....	24
4.1 Measurement principles.....	24
4.2 Offset compensation and dynamic range.....	28
4.3 AC Coupling mode.....	29
4.4 R&S ProbeMeter.....	30
5 Maintenance and service.....	31
5.1 Cleaning.....	31
5.2 Contacting customer support.....	31
5.3 Returning for servicing.....	32

5.4 Calibration interval.....	32
5.5 Storage.....	33
5.6 Disposal.....	33
5.7 Spare parts.....	33

1 Safety and regulatory information

The product documentation helps you to use the product safely and efficiently. Follow the instructions provided here and in the [Chapter 1.1, "Safety instructions"](#), on page 5.

Intended use

The product is intended for the development, production and verification of electronic components and devices in industrial, administrative, and laboratory environments. Use the product only for its designated purpose. Observe the operating conditions and performance limits stated in the data sheet.

The R&S RT-ZPR20/40 power-rail probe is designed for measurements on circuits that are only indirectly connected to the mains or not connected at all. It is not rated for any measurement category.

The probe is designed for usage with oscilloscopes that have a Rohde & Schwarz probe interface. Supported Rohde & Schwarz oscilloscopes are listed in the probe's data sheet.

Where do I find safety information?

Safety information is part of the product documentation. It warns you of potential dangers and gives instructions on how to prevent personal injury or damage caused by dangerous situations. Safety information is provided as follows:

- In [Chapter 1.1, "Safety instructions"](#), on page 5. The same information is provided in many languages as printed "Safety Instructions". The printed "Safety Instructions" are delivered with the product.
- Throughout the documentation, safety instructions are provided when you need to take care during setup or operation.

1.1 Safety instructions

Products from the Rohde & Schwarz group of companies are manufactured according to the highest technical standards. To use the products safely, follow the instructions provided here and in the product documentation. Keep the product documentation nearby and offer it to other users.

Safety instructions

Use the product only for its intended use and within its performance limits. Intended use and limits are described in the product documentation such as the data sheet, manuals and the printed "Safety Instructions". If you are unsure about the appropriate use, contact Rohde & Schwarz customer service.

Using the product requires specialists or specially trained personnel. These users also need sound knowledge of at least one of the languages in which the user interfaces and the product documentation are available.

Reconfigure or adjust the product only as described in the product documentation or the data sheet. Any other modifications can affect safety and are not permitted.

Never open the casing of the product. Only service personnel authorized by Rohde & Schwarz are allowed to repair the product. If any part of the product is damaged or broken, stop using the product. Contact Rohde & Schwarz customer service at <https://www.rohde-schwarz.com/support>.

In these safety instructions, the term "product" covers instruments (oscilloscopes), probes and their accessories.

Choosing the operating site

Only use the product indoors. The product casing is not waterproof. Water that enters can electrically connect the casing with live parts, which can lead to electric shock, serious personal injury or death if you touch the casing. If Rohde & Schwarz provides accessories designed for outdoor use of your product, e.g. a protective cover, you can use the product outdoors.

Unless otherwise specified in the data sheet, you can operate the product up to an altitude of 2000 m above sea level.

The product is suitable for pollution degree 2 environments where nonconductive contamination can occur. For more information on environmental conditions such as ambient temperature and humidity, see the data sheet.

Performing measurements

Take the following measures for your safety:

- To ascertain voltage-free state, use an appropriate voltage tester. Any measurement setup including an oscilloscope is not suitable for this purpose.
- The maximum input voltage on channel inputs and the external trigger input must not exceed the value specified in the data sheet.
- Observe all voltage and current ratings of the instrument, the probes, and the accessories. Exceeding the allowed voltages can lead to an electric shock.

Warning messages in the documentation

Limits and ratings are marked on the products and listed in the data sheets. Consider that the rated voltage depends on the frequency. The voltage limitation curves or values are provided in the data sheet.

- Never cause any short circuits when measuring sources with high output currents.
- Use only probes and accessories that comply with the measurement category (CAT) of your measurement task. The measurement category of the products is defined in the data sheet. If you use other than Rohde & Schwarz accessories, make sure that they are suitable for the instrument and the measurement task.
- Set the correct attenuation factor on the instrument according to the probe being used. Otherwise, the measurement results do not reflect the actual voltage level, and you might misjudge the actual risk.
- Prevent the probe from receiving mechanical shock. Avoid putting excessive strain on the probe cable or exposing it to sharp bends. Touching a broken cable during measurements can cause injuries.
- Set up all probe connections to the instrument before applying power.

1.2 Labels on the product

Labels on the casing inform about:

- Personal safety
- Product and environment safety
- Identification of the product

Table 1-1: Meaning of safety labels

	<p>Potential hazard Read the product documentation to avoid personal injury or product damage.</p>
---	--

1.3 Warning messages in the documentation

A warning message points out a risk or danger that you need to be aware of. The signal word indicates the severity of the safety hazard and how likely it will occur if you do not follow the safety precautions.

WARNING

Potentially hazardous situation. Could result in death or serious injury if not avoided.

CAUTION

Potentially hazardous situation. Could result in minor or moderate injury if not avoided.

NOTICE

Potential risks of damage. Could result in damage to the supported product or to other property.

2 Product description

2.1 Key characteristics and key features

The R&S RT-ZPR20/40 power-rail probe is designed for power integrity measurements. The R&S RT-ZPR20/40 is specifically built to measure small signals in the millivolt range with very large DC-offset components up to ± 60 V. It is thus perfectly suited to measure small perturbations on DC power rails.

The probe consists of a probe box with an SMA connector and various accessories for different applications.

Since the probe is equipped with the Rohde & Schwarz probe interface, it can be connected to any Rohde & Schwarz base unit that is compatible with this interface and has the required firmware. When connected to the front panel of a supported Rohde & Schwarz oscilloscope, the probe is controlled via the software dialog of the oscilloscope. For a list of compatible base units, see the data sheet of the probe.

The key characteristics of the probe are the following:

- Bandwidth:
 - DC to 2.0 GHz for R&S RT-ZPR20
 - DC to 4.0 GHz for R&S RT-ZPR40
- Extremely low noise, only 10 % additional to your scope noise
- Dynamic range: ± 850 mV
- High offset capability: ± 60 V
- Maximum non-destructive input voltage: ± 60 V DC or ± 5 V AC (peak) between center conductor and ground
- AC coupling with low-frequency cutoff at 10 Hz
- DC input resistance: 50 k Ω
- Extremely low zero and gain errors over temperature
- R&S ProbeMeter with dynamic range ± 60 V and measurement error < 0.1 %
- Rohde & Schwarz probe interface

2.2 Unpacking and checking

1. Unpack the product carefully.
2. Retain the original packing material. Use it when transporting or shipping the product later.
3. Using the delivery notes, check the equipment for completeness.
4. Check the equipment for damage.

If the delivery is incomplete or equipment is damaged, contact Rohde & Schwarz.

Delivery notes

The delivery contains the following items:



- R&S RT-ZPR20/40 power-rail probe
- Carrying case
- Accessory boxes
- Pigtail cables
- User manual
- Data sheet
- Calibration certificate
- Documentation of calibration values (if ordered)
- Safety instructions for oscilloscopes and accessories (multilingual)
- R&S RT-ZA25 power rail browser kit

Accessories supplied with the probe are listed in [Chapter 2.5.1, "Supplied accessories"](#), on page 11.

2.3 Description of the probe

The probe consists of the active probe box with an Rohde & Schwarz probe interface to connect to the oscilloscope, and an SMA connector to connect to the DUT. Use the SMA interface to connect the supplied solder-in and extension cables or the power rail browser.

2.4 Probe box

The probe box connects the probe to the oscilloscope via the Rohde & Schwarz probe interface. The Rohde & Schwarz probe interface contains a male precision 7 mm (276 mil) BNC connector and six pogo pin connectors. This interface provides the required supply voltage and is also used for simultaneously transmitting analog signals and digital data. All the analog voltages required by the probe are generated in the probe box. This approach ensures you can operate future probes on any base unit that features a Rohde & Schwarz probe interface. The probe box provides an SMA connector to screw on different accessories suitable for various measurement tasks.

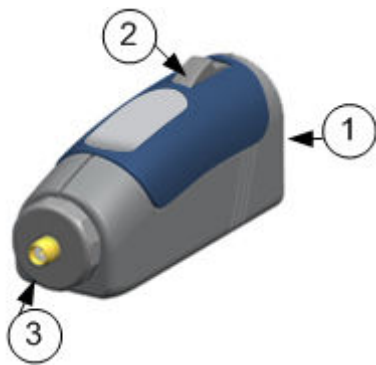

- (1) Rohde & Schwarz probe interface with 7 mm (276 mil) coaxial connector and 6 pogo pins
- (2) Release knob
- (3) SMA connector

Connect the probe only to an instrument with Rohde & Schwarz probe interface. Never connect it to a usual BNC jack, because this can damage the probe interface.



2.5 Accessories and items

2.5.1 Supplied accessories

Before you can use the probe for measurements, connect one of the accessories to the SMA connector at the probe box.

[Table 2-1](#) shows the accessories that are supplied with the R&S RT-ZPR20/40 power-rail probe.

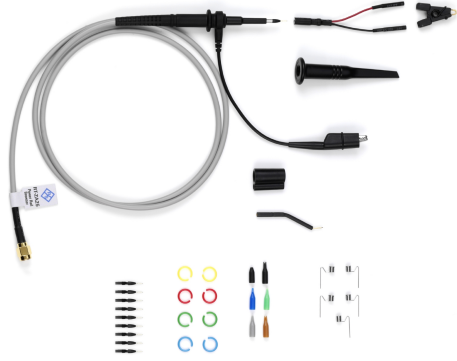
Table 2-1: Supplied accessories

Item	Quantity	Description
	1	<p>R&S RT-ZA25 power rail browser kit includes:</p> <ul style="list-style-type: none"> • Power rail browser • Ground lead with alligator clip • Ground spring (5) • IC cap (5) • Tip insulating cap • Tip (5) • Spring tip (5) • Sprung hook • Micro SMD clip • Dual adapter • Flexible ground lead with adapter • Coding rings (8) • Short tube • Long tube
	3	R&S RT-ZA26 pigtail cable, 15 cm
	1	<p>SMA extension cable, 1 m (R&S RT-ZPR20)</p> <p>SMA extension cable low loss, 1 m (R&S RT-ZPR40)</p>

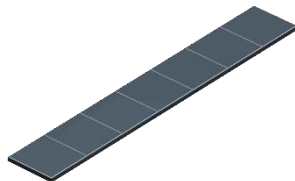

Item	Quantity	Description
	1	Solder wire, lead free, 5 m
	7	Adhesive pads

For a list of spare parts, see [Chapter 5.7, "Spare parts"](#), on page 33.

2.5.2 Optional accessories

If the delivered accessories do not meet individual customer requirements, Rohde & Schwarz offers different accessory sets for sale. The order numbers are provided in the data sheet.

Table 2-2: Optional accessories

Item	Description
	<p>R&S RT-ZA9 probe box to N / USB adapter</p> <p>The adapter connects the R&S RT-ZPR20/40 power-rail probe to any other oscilloscope or any other measurement instrument (e.g. a network or spectrum analyzer).</p> <p>Using the USB interface of the adapter, the probe can be powered and controlled from any conventional PC. However, full software functionality is only provided by the supported oscilloscopes (see data sheet).</p>
	<p>R&S RT-ZA10 SMA adapter</p> <p>SMA adapter with SMA (female) jack to BNC (male) plug.</p>

Item	Description
	<p>R&S RT-ZA50 probe interface extender</p> <p>The adapter is a breakout box that leads out the R&S probe interface to the following standard connectors: USB-C for power and control, SMA for signal and DC jack for auxiliary supply.</p> <p>Together with the R&S RT-ZA51 probe to 3.5 mm adapter, it moves the R&S probe interface closer to your test setup.</p>
	<p>R&S RT-ZA51 probe to 3.5 mm adapter</p> <p>The probe adapter has an R&S probe interface and standard connectors USB-C, 3.5 mm and DC jack. Using this adapter, you can power and control your Rohde & Schwarz probe without an appropriate Rohde & Schwarz oscilloscope.</p> <p>Together with the R&S RT-ZA50 probe to 3.5 mm adapter, it moves the R&S probe interface closer to your test setup.</p>
	<p>R&S RT-ZAP probe positioner</p> <p>Use the R&S RT-ZAP probe positioner to position and stabilize your probe.</p>
	<p>R&S RT-ZF20 power deskew fixture</p> <p>The R&S RT-ZF20 power deskew fixture is a tool to align the time delay (skew) of any combination of Rohde & Schwarz voltage and current probes. The fixture can be used with any oscilloscope.</p>

2.5.3 Service accessories

To order accessories for servicing the probe, contact your Rohde & Schwarz service center. The following accessories are available:

Table 2-3: Service accessories

Item	Description
R&S RT-ZK1	The service kit is used to calibrate the probe, to do performance tests, and for servicing. The service kit includes all adapters and accessories to connect the probe to the required measuring instruments.
R&S RT-ZPR20/40 Service Manual	The service manual contains a detailed description of the performance test to verify the specifications, and other important service procedures.

3 Connecting the probe

Read and observe [Chapter 1.1, "Safety instructions"](#), on page 5.

3.1 Handling the probe

The R&S RT-ZPR20/40 can withstand a moderate amount of physical and electrical stress. To avoid damage, treat the probe with care:

- Handle the probe by the probe box.
- Prevent the probe from receiving mechanical shock.
- Avoid strain on the probe cable and route it carefully.
- Do not spill liquids on the probe.

3.2 Connecting the probe to the oscilloscope

The probe is designed for usage with oscilloscopes that have a Rohde & Schwarz probe interface. Supported Rohde & Schwarz oscilloscopes are listed in the probe's data sheet.

To ensure proper grounding, connect the oscilloscope to an outlet with protective conductor terminal.

1. If the extension cable is connected to the probe box, disconnect it. To avoid damage to the device, connect the cable only to a grounded probe box.
2. If your DUT is floating and not grounded, connect the DUT ground to the oscilloscope ground before connecting the probe to your DUT.
3. **NOTICE!** Risk of damaging the probe.
Connect the probe only to an instrument with Rohde & Schwarz probe interface. Never connect it to a usual BNC jack, because this can damage the probe interface.

Connect the probe box (1) to the Rohde & Schwarz probe interface of the base unit (2).

The probe snaps in when connected properly to the port.

Connecting the probe to the oscilloscope

4. Connect the extension cable to the probe box.

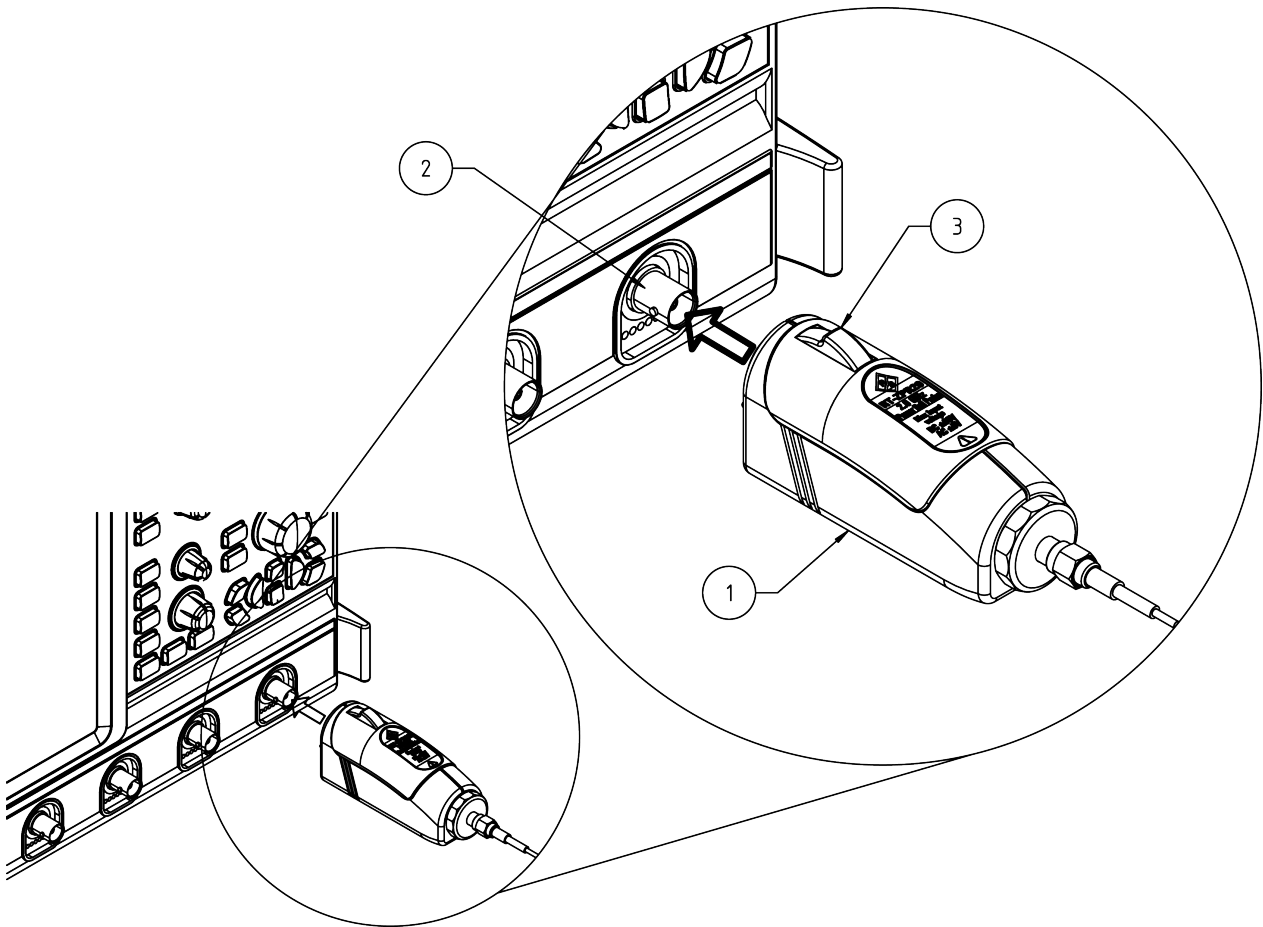

Figure 3-1: Connecting the probe to the Rohde & Schwarz oscilloscope

Disconnecting

1. Disconnect the accessories from the probe box before changing a probing point, or before disconnecting the probe box from the oscilloscope.
2. To disconnect the probe:
 - a) Press and hold the release button (3).
 - b) Pull the probe box away from the oscilloscope.

During usage, the probe slightly heats up. Warming is normal behavior and not a sign of malfunction.

3.3 Identification of the probe

When the probe is connected to the oscilloscope, the oscilloscope recognizes the probe and reads out the probe-specific parameters.

The oscilloscope settings for attenuation and offset are automatically adjusted. After the probe is connected to the oscilloscope and the settings are adjusted, the waveform is shown for the channel to which the probe is connected.

The complete probe information is shown in the probe settings dialog. For more information, refer to the user manual of your oscilloscope.

3.4 Connecting the probe to the DUT

This chapter describes how to connect the probe to the DUT using different accessories supplied for the R&S RT-ZPR20/40 probe. The various accessories are described and their use is explained.

The recommended configurations are designed to give the best probe performance for different probing situations, to measure with confidence in the performance and signal fidelity. Using the recommended connection configurations is your key to making accurate oscilloscope measurements with known performance levels.

Using solder-in accessories

Some solder-in accessories are very fine and sensitive. Stabilize the probe using appropriate means (e.g. adhesive pads, probe positioner) in order to protect the solder joint from excessive mechanical stress.

Before soldering or unsoldering the pigtail cable, disconnect the pigtail cable from the probe box.

Observe voltage limits

The maximum non-destructive input voltage is ± 60 V DC or ± 5 V AC (peak). A higher input voltage can destroy the probe.

Observe operating temperature range

The R&S RT-ZPR20/40 probe box has a specified operating temperature range from 0 °C to 40 °C, whereas the pigtail and extension cables can withstand wider

Connecting the probe to the DUT

temperature ranges (see [Chapter 3.4.2, "R&S RT-ZA26 pigtail cable"](#), on page 21). Do not subject the probe box to temperatures outside of its operating range.



3.4.1 R&S RT-ZA25 power rail browser kit

The R&S RT-ZA25 power rail browser kit allows handheld probing with maximum convenience at the DUT and is sufficient up to 350 MHz bandwidth.

To avoid damaging the browser parts, use them carefully:

- Do not apply a side load to the browser.
 - Do not apply too much force when browsing. The weight of the probe in your hand is sufficient.
 - Always remove the browser from the DUT before disconnecting the probe from the oscilloscope.
1. **CAUTION!** Risk of injuries. Always observe the maximum rating of ± 60 V DC or ± 5 V AC (peak). The R&S RT-ZA25 is not equipped with a protective impedance and must not be used to measure higher voltages.
Connect the R&S RT-ZA25 power rail browser to the SMA interface of the R&S RT-ZPR20/40 probe box.
 2. Use the browser in the same way as conventional passive probes.

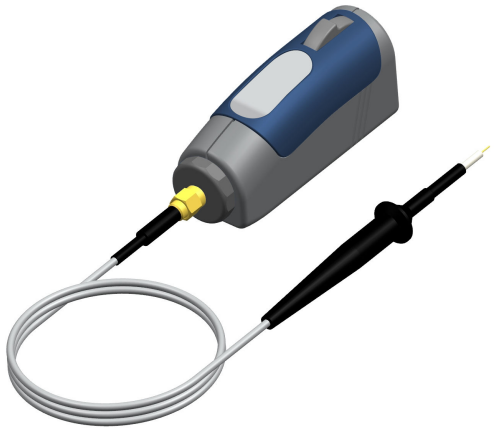
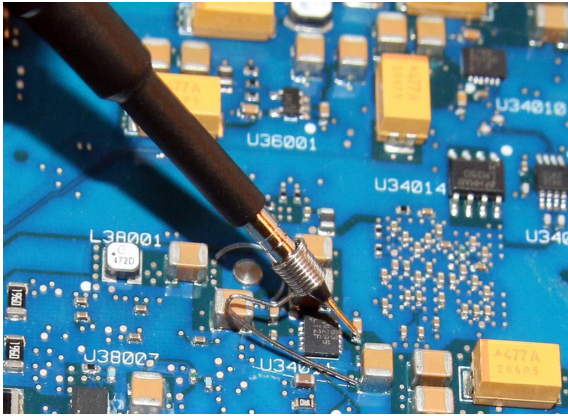
Connecting the probe to the DUT

 A blue and grey power rail browser probe with a black handle and a yellow connector. A coiled grey cable is attached to the handle.	<p>R&S RT-ZA25 power rail browser Bandwidth: > 350 MHz Length: 1 m Temperature range: 0 °C to +40 °C</p>
 A close-up view of a probe tip with a ground spring and a signal tip, making contact with a blue printed circuit board (PCB). Various components and labels like U36001, U34014, L38001, U38007, and U340 are visible on the board.	<p>For highest bandwidth and signal integrity, use the ground spring and spring loaded or rigid signal tips.</p>
 A coiled grey cable with a black handle and a black adapter at the end. The adapter has two gold-colored signal tips.	<p>For convenient probing and medium bandwidth, use the flexible ground lead with adapter.</p>

Connecting the probe to the DUT



Use the long-distance ground lead with alligator clip to contact far away ground points. Due to the larger loop inductance, bandwidth is decreased.

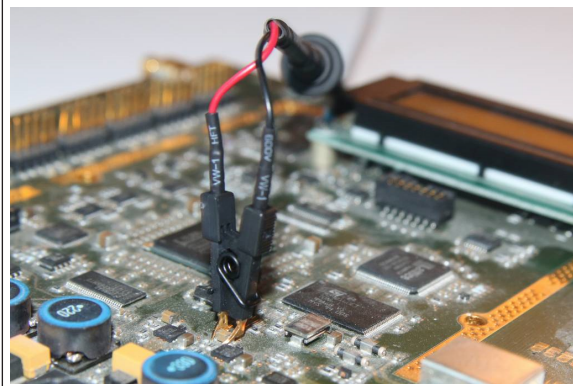

Use the dual adapter to plug onto pin strips or to connect the micro SMD clip.
Use the micro SMD clip to connect surface mount devices, e.g. 0805, 0402 capacitors.



3.4.2 R&S RT-ZA26 pigtail cable

The R&S RT-ZA26 pigtail cable is a semi-permanent solder-in connection that supports the full bandwidth of the probe.

When using the R&S RT-ZA26 pigtail cable, observe the valid temperature ranges for the R&S RT-ZPR20/40 probe box. See also "[Observe operating temperature range](#)" on page 18.

1. Disconnect the cable from the probe box before soldering or unsoldering the pigtail cable.
2. Solder the conductors of the pigtail cable.
3. Connect the R&S RT-ZA26 pigtail cable to the SMA extension cable.
4. Connect the other end of the SMA cable to the R&S RT-ZPR20/40 probe box.

Connecting the probe to the DUT

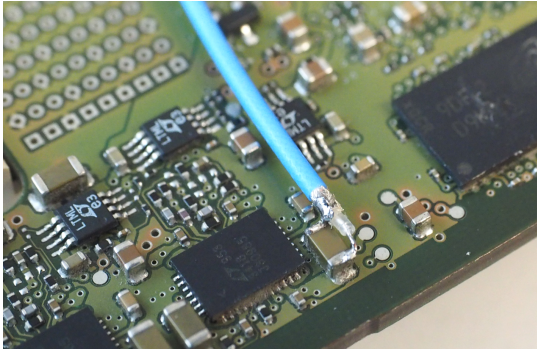
	<p>The R&S RT-ZA26 pigtail cable is well suited for creating solid contact with test points that are hard to reach (e.g. IC pins, SMT parts).</p> <p>Bandwidth:</p> <ul style="list-style-type: none"> • > 2 GHz (R&S RT-ZPR20) • > 3.5 GHz (R&S RT-ZPR40) <p>Length: 15 cm (1.15 m with SMA extension cable)</p> <p>Temperature range: -55 °C to +125 °C</p>
	<p>Never connect the R&S RT-ZA26 pigtail cable directly to the probe box. Always use the SMA extension cable.</p>
	<p>For measurements, solder the center conductor to the signal and the outer shield conductor to the ground.</p>

3.4.3 SMA extension cable

The supplied SMA extension cable is a semi-permanent screw connection that supports the full bandwidth of the probe.

Connecting the probe to the DUT

	<p>The SMA extension cable is well suited for connections to existing SMA (m) ports at your test circuit. Due to the design of the coaxial interface, ground loop impedance is minimized. Thus, this connection provides highest signal integrity. Connection to other coaxial interfaces like SMA (f), BNC, SMP, SMB is possible using the appropriate adapter. Coaxial adapters are not part of the R&S RT-ZPR20/40 accessories set.</p> <p>Bandwidth:</p> <ul style="list-style-type: none">• > 2 GHz (R&S RT-ZPR20)• > 4 GHz (R&S RT-ZPR40) <p>Length: 1 m</p> <p>Temperature range:</p> <ul style="list-style-type: none">• -55 °C to +125 °C (SMA extension cable)• -45 °C to +85 °C (SMA extension cable low loss)
---	---

4 Features and characteristics

4.1 Measurement principles

The R&S RT-ZPR20/40 power-rail probe provides an electrical connection between the DUT and the oscilloscope. The probe transfers the voltage of the electrical signal tapped off the DUT to the oscilloscope, where it is displayed graphically.

Although a probe has a wide variety of specifications, these specifications can be grouped into two classes of basic requirements:

- High signal integrity of the transferred signal: With an ideal probe, the output signal that is transferred to the base unit would be identical to the input signal between the probe tips. Furthermore, signal integrity would be extremely high. Every real probe, however, transfers the input signal in altered form. A good probe causes only minimum alterations. How the probe can fulfill this requirement is mainly determined by its bandwidth.
- Low loading of the input signal: Every probe is a load for the signal to be measured. This means that the signal to be measured changes as soon as the probe is connected. A good probe should cause only a minimum change to the signal, so that the function of the DUT is not adversely affected. How well the probe can fulfill this requirement is mainly determined by its input impedance.

The parameters of a probe are usually specified for a minimized connection between the probe and the DUT. With longer connections, the connection inductance has a significant effect on the measurement. The high-frequency behavior of the power rail probe is typically characterized with $0\ \Omega$ source impedance. [Figure 4-1](#) shows the R&S RT-ZPR20/40 power-rail probe that is connected to the DUT.

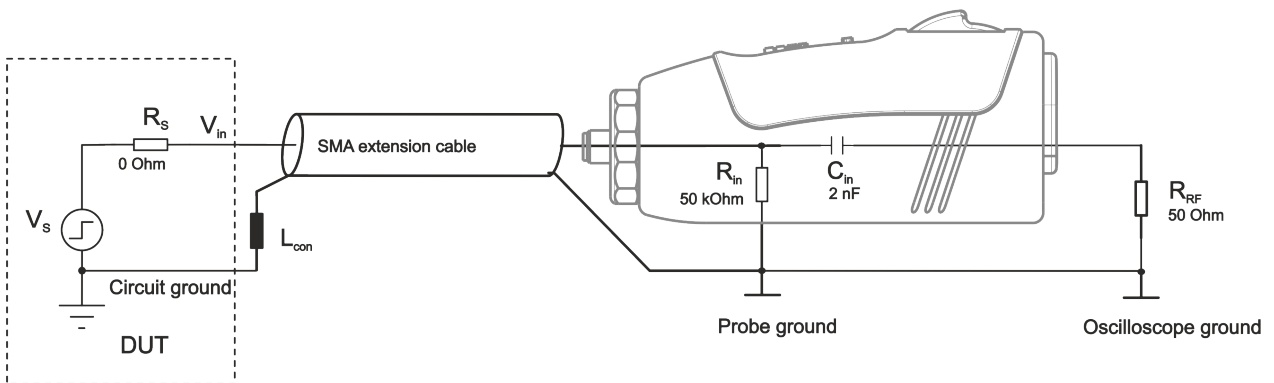

Figure 4-1: Equivalent circuit model of the R&S RT-ZPR20/40 probe

Abbreviation	Description
V_s	Voltage at the test point without probe connected
V_{in}	Voltage at the test point with probe connected, corresponds to the input voltage of the probe
R_s	Source impedance of the DUT
R_{in}	DC input resistance of the probe
R_{RF}	RF input resistance
C_{in}	Coupling capacitance
L_{con}	Parasitic inductance of the ground connection

4.1.1 Step response

Figure 4-2 shows the step response of the R&S RT-ZPR20/40 with an ideal input step.

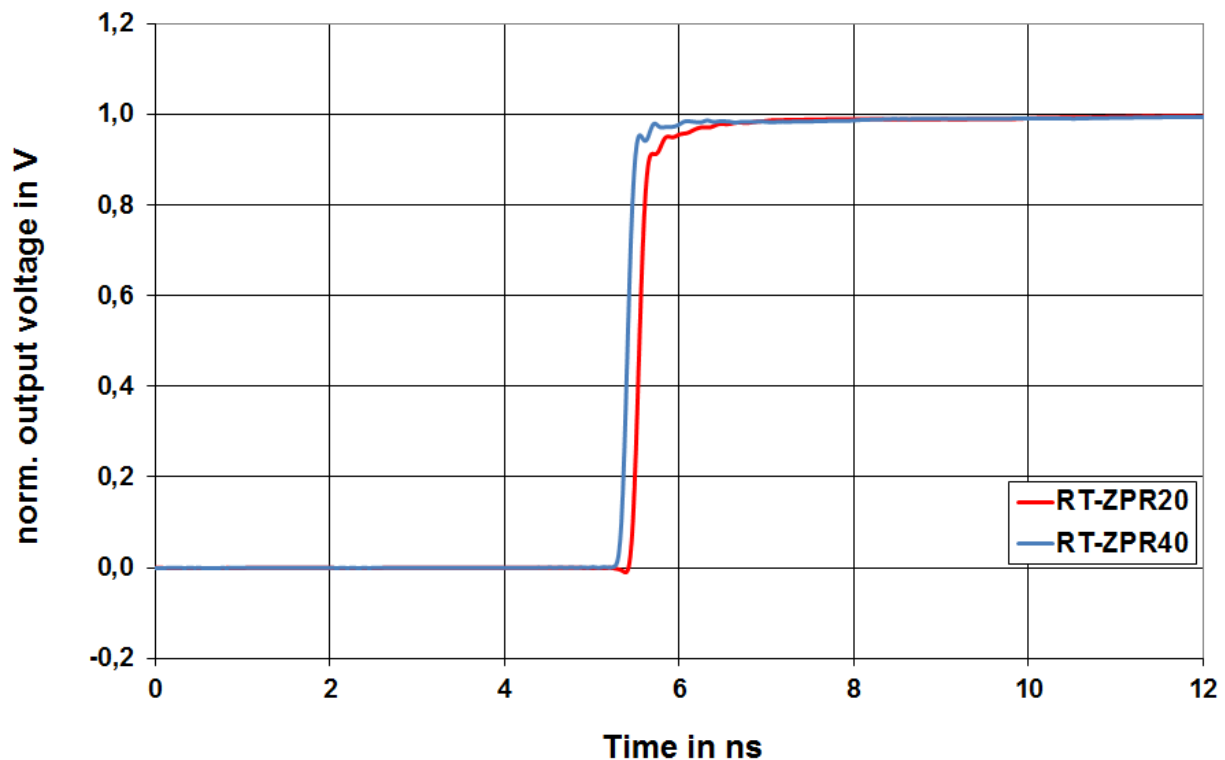

Figure 4-2: Example of the step response of the R&S RT-ZPR20/40 probe with the supplied SMA extension cable

4.1.2 Frequency response

The R&S RT-ZPR20/40 probe is a dedicated power rail probe, designed for measurements at low impedance voltage sources such as DC power supplies with an output impedance < 1 Ohm.

A DUT with an output impedance (R_S) higher than 1 Ohm leads to a mismatch between DC gain and AC gain. The mismatch causes a step at 1 MHz and thus non-flat frequency response.

In the time domain, a non-ideal frequency response occurs as a step which only gradually approaches the final DC value.

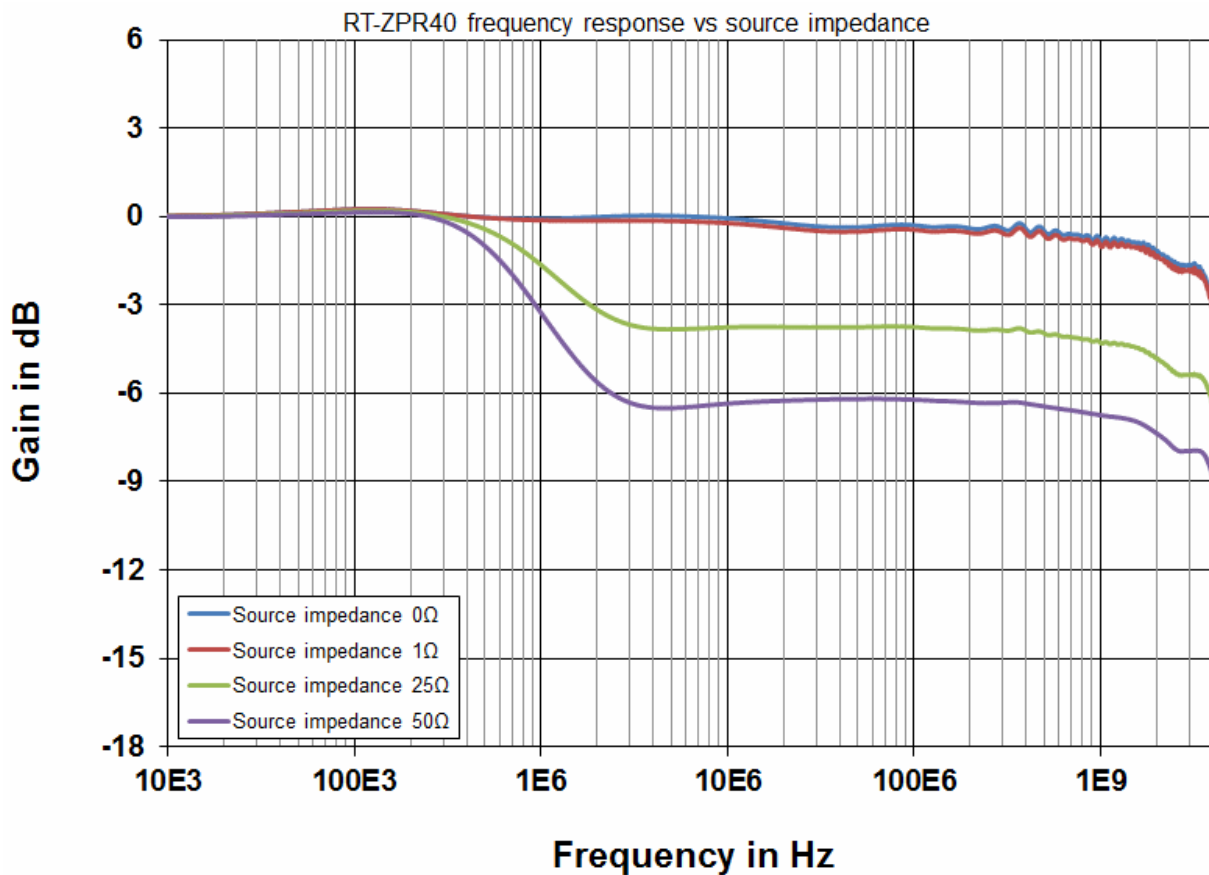

Figure 4-3: Example of the frequency response of the R&S RT-ZPR40 probe with SMA extension cable for different source impedances

4.1.3 Input impedance

The input signal loading caused by the probe is determined by its input impedance Z_{in} . Figure 4-1 illustrates an equivalent circuit model. The resulting input impedance versus frequency is indicated in Figure 4-4.

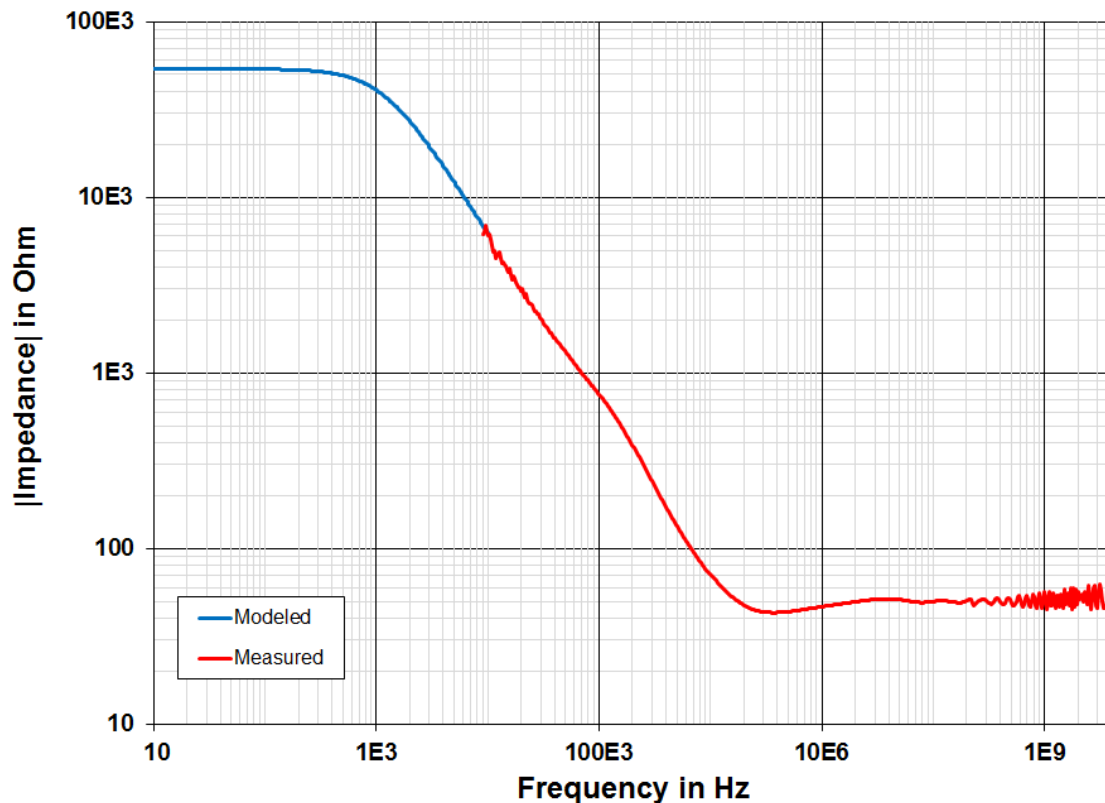

Figure 4-4: Example of the input impedance of the R&S RT-ZPR20/40 probe with SMA extension cable as a function of frequency

4.2 Offset compensation and dynamic range

The dynamic range for the R&S RT-ZPR20/40 power rail probe determines the maximum voltage swing that may occur between the input terminal and ground.

The dynamic range of the R&S RT-ZPR20/40 is ± 0.850 V. If this range is exceeded, an unwanted signal clipping may occur.

The R&S RT-ZPR20/40 probe features a very comprehensive offset compensation function. The compensation of DC components directly inside the probe box even in front of the active probe amplifier is possible with an extremely wide compensation range of ± 60 V. This function is useful when measuring AC signals with a high superimposed DC component.

- Adjust the offset at the oscilloscope. You can use the vertical [Position] knob, or the offset setting in the channel or probe setup.

For details, refer to the user manual of your oscilloscope.

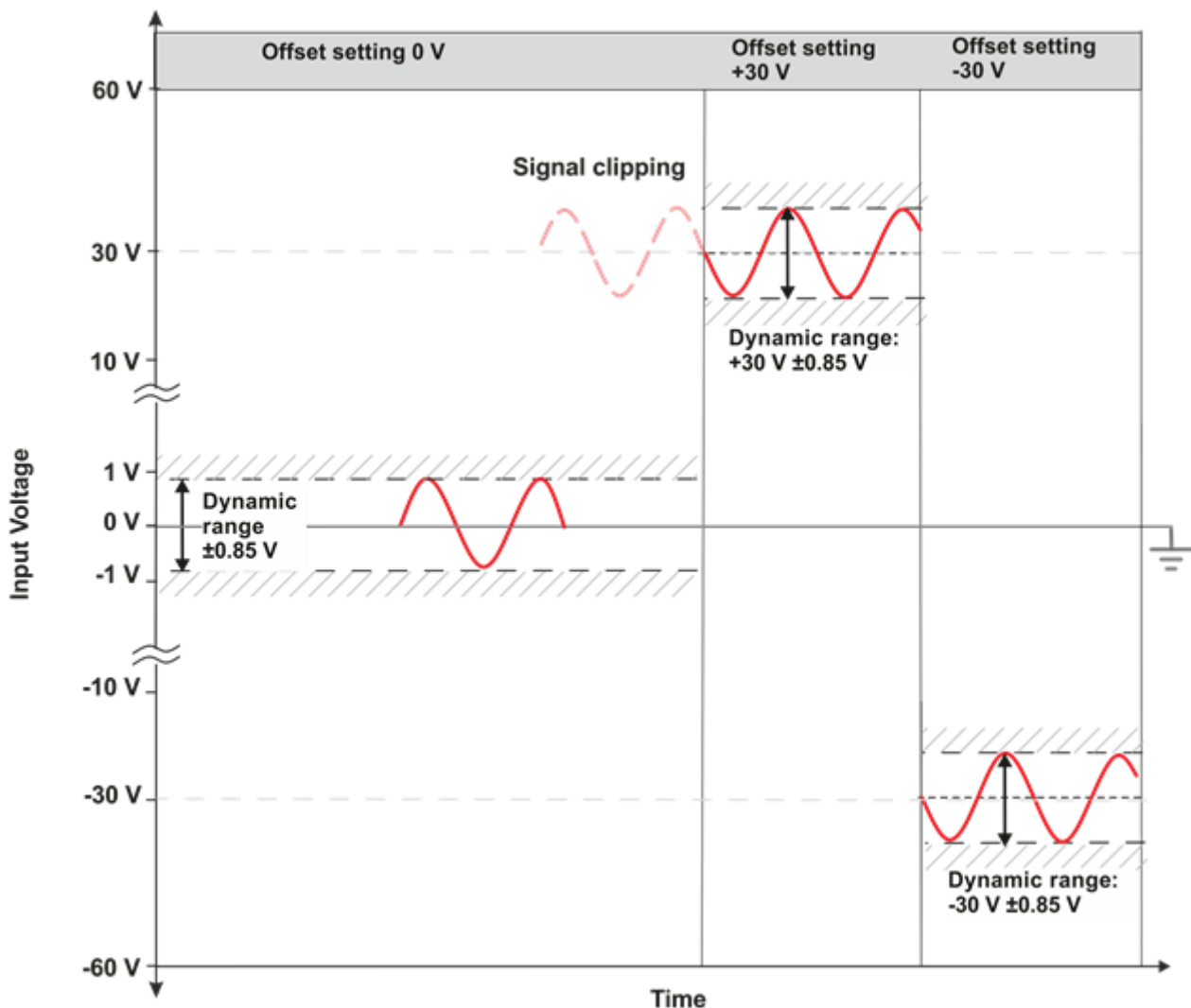

Figure 4-5: Offset compensation voltage and dynamic range

4.3 AC Coupling mode

The R&S RT-ZPR20/40 power-rail probe features an internal AC coupling mode with a low frequency cutoff at 10 Hz to block DC components of the input signal. The AC coupling is set inside the probe, the full bandwidth of the probe remains.

"AC coupling" is part of the probe settings of the channel to which the probe is connected. For more details, see the oscilloscope's user manual.

4.4 R&S ProbeMeter

The R&S ProbeMeter is an integrated voltmeter that measures DC voltages with higher precision compared to the oscilloscope's DC accuracy. The DC voltage is measured continuously and runs parallel to the time domain measurement of the oscilloscope.

High-precision measurements are achieved by immediate digitization of the measured DC voltage at the probe tip.

When the R&S ProbeMeter is active, the measured values are displayed on the oscilloscope. The R&S ProbeMeter state is part of the probe settings of the channel to which the probe is connected. For details, refer to the user manual of the Rohde & Schwarz oscilloscope.

Advantages of the R&S ProbeMeter:

- Measures DC voltages of different levels, no need to adjust the measurement range of the oscilloscope.
- True DC measurement (integration time > 100 ms), not mathematical average of displayed waveform.
- High measurement accuracy and low temperature sensitivity.
- Simple means of setting the oscilloscope's trigger level and vertical scaling if a waveform is not visible.
- Independent of oscilloscope settings for position, vertical scale, horizontal scale, and trigger.
- Measurement range ± 60 V

5 Maintenance and service

Like all Rohde & Schwarz products, Rohde & Schwarz probes and adapters are of high quality and require only minimum service and repair. However, if service or calibration is needed, contact your Rohde & Schwarz service center. Return a defective product to the Rohde & Schwarz service center for diagnosis and exchange.

5.1 Cleaning

1. Clean the outside of the product using a soft cloth moistened with either distilled water or isopropyl alcohol. Keep in mind that the casing is not waterproof.

Note: Do not use cleaning agents. Solvents (thinners, acetone), acids and bases can damage the labeling or plastic parts.

2. Dry the product completely before using it.

5.2 Contacting customer support

Technical support – where and when you need it

For quick, expert help with any Rohde & Schwarz product, contact our customer support center. A team of highly qualified engineers provides support and works with you to find a solution to your query on any aspect of the operation, programming or applications of Rohde & Schwarz products.

Contact information

Contact our customer support center at www.rohde-schwarz.com/support, or follow this QR code:



Figure 5-1: QR code to the Rohde & Schwarz support page

5.3 Returning for servicing

Use the original packaging to return your R&S RT-ZPR20/40 to your Rohde & Schwarz service center. A list of all service centers is available on:

www.services.rohde-schwarz.com

If you cannot use the original packaging, consider the following:

1. Use a sufficiently sized box.
2. Protect the product from damage and moisture (e.g. with bubble wrap).
3. Use some kind of protective material (e.g. crumpled newspaper) to stabilize the product inside the box.
4. Seal the box with tape.
5. Address the package to your nearest Rohde & Schwarz service center.

5.4 Calibration interval

The recommended calibration interval for R&S RT-ZPR20/40 power-rail probe is two years. For servicing, send the probe to your nearest Rohde & Schwarz service center (see [Chapter 5.3, "Returning for servicing"](#), on page 32).

5.5 Storage

Protect the product against dust. Ensure that the environmental conditions, e.g. temperature range and climatic load, meet the values specified in the data sheet.

Store the product in a shock-resistant case, e.g. in the shipping case.

5.6 Disposal

Rohde & Schwarz is committed to making careful, ecologically sound use of natural resources and minimizing the environmental footprint of our products. Help us by disposing of waste in a way that causes minimum environmental impact.

Disposing electrical and electronic equipment

A product that is labeled as follows cannot be disposed of in normal household waste after it has come to the end of its service life. Even disposal via the municipal collection points for waste electrical and electronic equipment is not permitted.



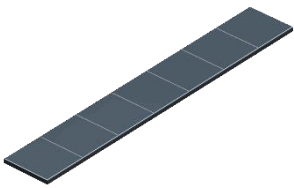





Figure 5-2: Labeling in line with EU directive WEEE



Rohde & Schwarz has developed a disposal concept for the eco-friendly disposal or recycling of waste material. As a manufacturer, Rohde & Schwarz completely fulfills its obligation to take back and dispose of electrical and electronic waste. Contact your local service representative to dispose of the product.

5.7 Spare parts

The following accessories can be ordered at the Rohde & Schwarz service center. Use the order numbers provided in the following table.

Table 5-1: Accessories spare parts

Pos	Item	Description	Part Number
1		Adhesive pads	1800.4268.00
2		Solder wire, lead free, 5 m	1800.4097.00
3		SMA extension cable, 1 m For R&S RT-ZPR20	1800.5241.00
4		SMA extension cable low loss, 1 m For R&S RT-ZPR40	1337.9081.00
Spare parts for the R&S RT-ZA25 power rail browser kit			
5		Ground lead with alligator clip	1800.5335.00
6		Dual adapter	1800.5341.00

Pos	Item	Description	Part Number
7		Micro SMD clip	1800.5358.00
8		Flexible ground lead with adapter	1800.5364.00

The following accessories can be ordered from Rohde & Schwarz. The order numbers are listed in the data sheet.

- R&S RT-ZA25 power rail browser kit
- R&S RT-ZA26 pigtail cable, 15 cm

Table 5-2: Parts for ESD prevention

Pos.	Item	Material number
1	ESD wrist strap	0008.9959.00
2	ESD grounding cable	1043.4962.00