

Massive MIMO

Eight things to consider when testing antenna arrays

Massive MIMO makes it possible to increase data throughput and coverage in real-world networks. Such active antenna arrays become indispensable for 5G base stations. Get a concise overview of key aspects of massive MIMO technology and related testing challenges.

Further information and more detailed explanations are available in application notes, webinars and videos at

www.rohde-schwarz.com/5G

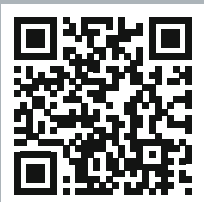

1. What is massive MIMO?

Multiple input multiple output (MIMO) is a technology that has been in use for many years. MIMO utilizes many antennas at the transceiver to improve diversity gain. It also takes advantage of uncorrelated propagation paths for higher efficiency and high throughput and/or to allow simultaneous access for different users.

In massive MIMO systems, a very high number of antenna elements is used at the transceiver, which allows two major concepts to be dynamically combined: beamforming and spatial multiplexing, both brought about by the ability of the many antenna elements to focus their energy into smaller regions of space. If an antenna system can do this, we refer to that antenna system as massive MIMO. Massive MIMO is mainly applied at base stations. 5G user devices may implement basic beamforming schemes.

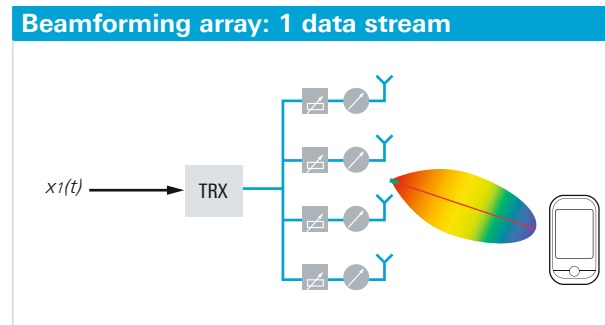
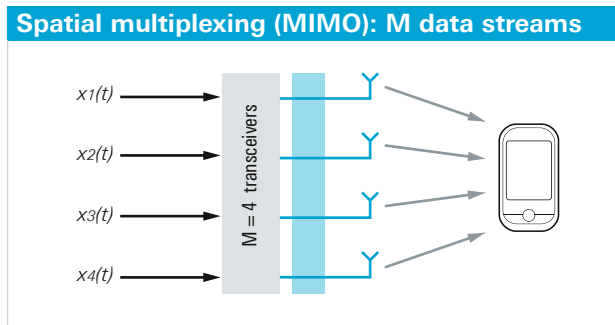

Massive MIMO:
combining beamforming with MIMO results in MU-MIMO with M antennas >> # of UEs

Massive arrays of 128 to 1024 active antenna elements

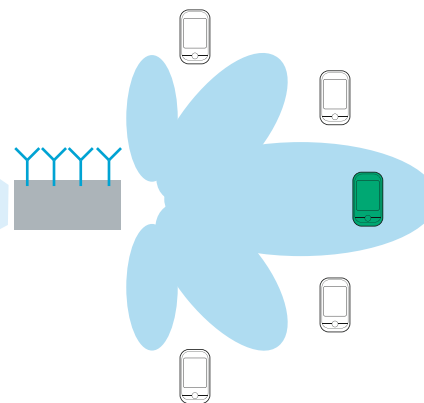
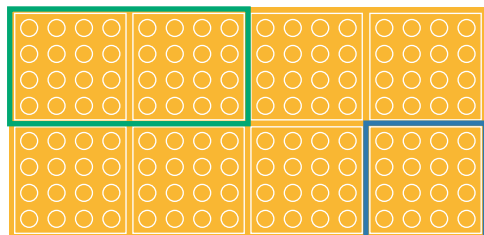

Multi-user MIMO (MU-MIMO)

Increase SINR and capacity for each user, i.e.:

UE1: 32 antennas, beamforming with 16x2 MIMO

UE2: 16 antennas, beamforming with 8x2 MIMO

2. Why use massive MIMO?

There are many advantages to using massive MIMO with beamforming. The most important one is the improvement in energy efficiency that results from increasing the antenna gain by bundling the transmitted energy. Doing this also increases the range and reduces inter-cell interference. At higher frequencies (e.g. millimeterwave), there is the additional challenge of higher path loss, but the advantage of smaller antenna size. At higher frequencies, the large number of antenna elements can be used to generate a very narrow beam with large gain, and at lower frequencies, the large number of antenna elements can be used to generate multiple spatial streams.

Using beamforming strategies in user devices and base station equipment will require the need for over-the-air testing (as opposed to standard conducted testing) to ensure that the beams are pointing in the right direction. At high frequencies, conducted testing becomes much more challenging and expensive, for example due to the high losses associated with the cables.

Massive MIMO improves energy efficiency and capacity

Traditional base station antenna

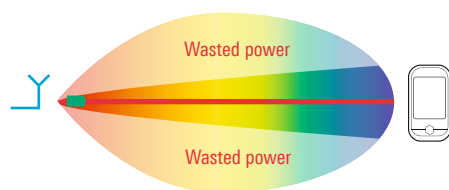

Massive MIMO antenna array

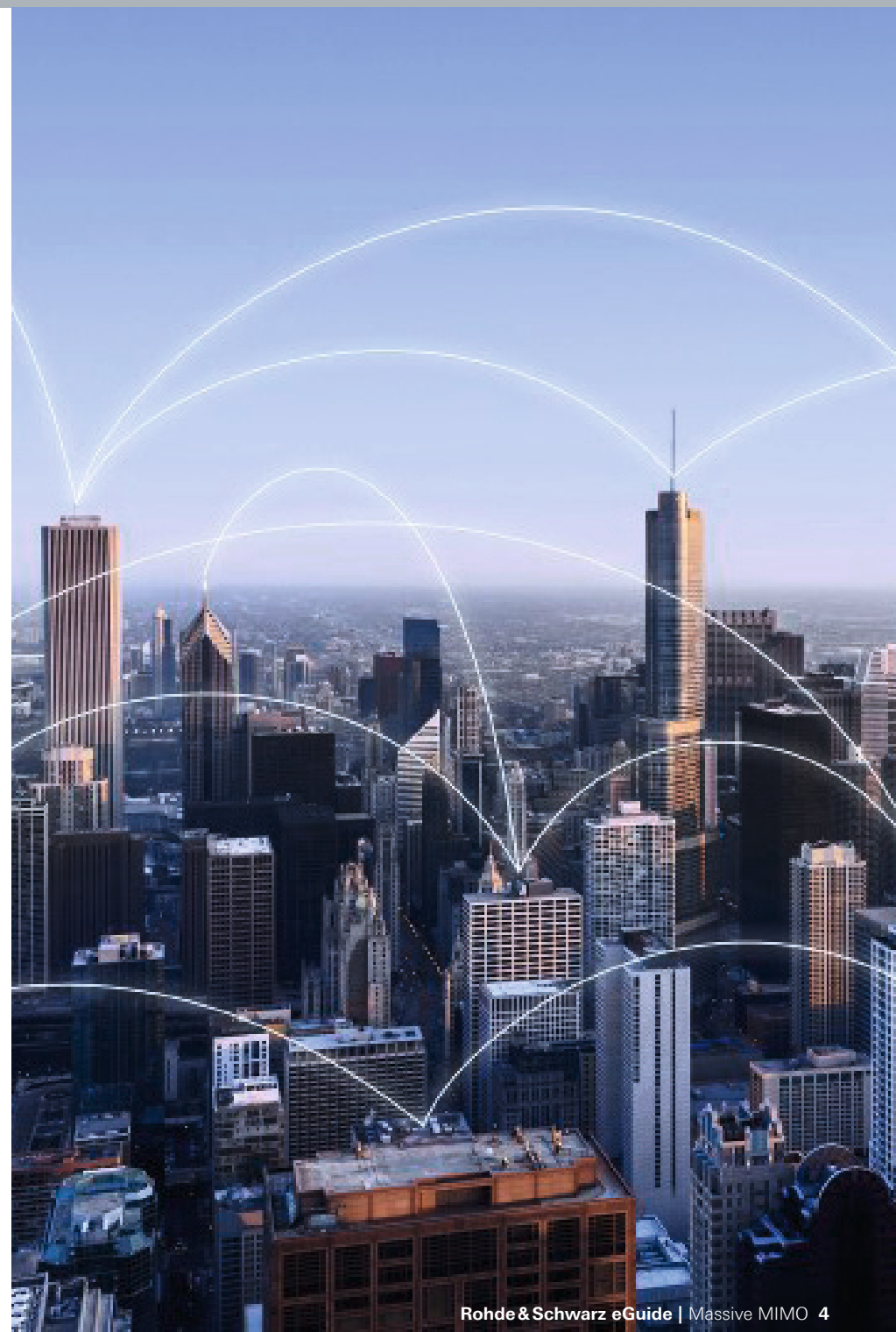
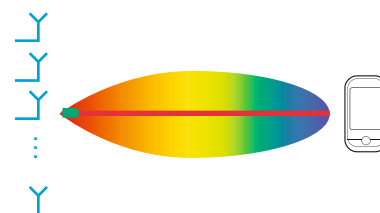

3. What are the biggest challenges with massive MIMO?

Although it has many advantages, massive MIMO has many challenges to consider.

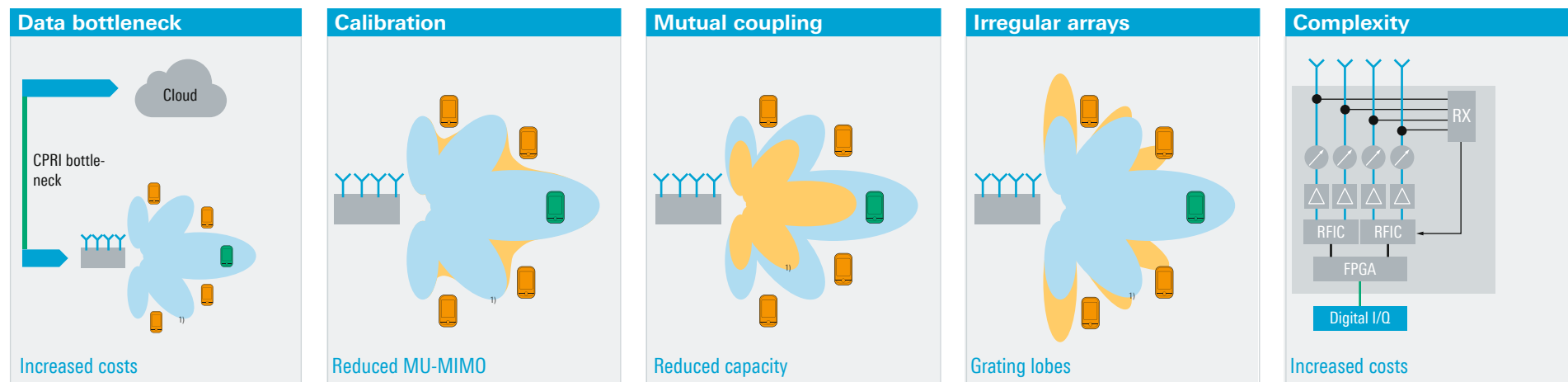

There is the potential to create a data bottleneck due to the large amount of data being sent and received by the massive MIMO antenna systems as part of a centralized RAN system, requiring adequate fiber bandwidth.

Given the large number of antenna elements, beamforming antennas that are not calibrated properly will suffer from unwanted emissions in unwanted directions, e.g. beam squint, which is basically jitter of the beam boresight.

Mutual coupling between antenna elements results in energy loss and thus a reduction in the maximum range.

In going from theory to practice, some antenna arrays will need to be designed in nongeometric shapes that may result in dissipating energy in undesired directions.

Massive MIMO antenna systems represent a new level of complexity from a design, manufacturing, calibration and deployment perspective. And with this new level of complexity also comes the need for new design and test approaches.

¹⁾ ■ ideal pattern
 ■ resulting pattern

4. What are the different types of beamforming used for massive MIMO systems?

Achieving a certain directivity or beamforming requires an antenna array where the RF signal at each antenna element is amplitude and phase weighted. There are three possible ways to apply amplitude and phase shifts.

Analog beamforming

The traditional approach, used for example in radar applications, applies an antenna array combined with phase shifters and power amplifiers to steer the beam into the desired direction, reducing the sidelobes to a minimum. The small amount of hardware makes this a cost-effective method for building a beamforming array of a certain complexity. Typically, an analog beamforming array is connected to one RF chain generating only one beam at a time, and the range of the phase shifters used limits the applicable frequency range.

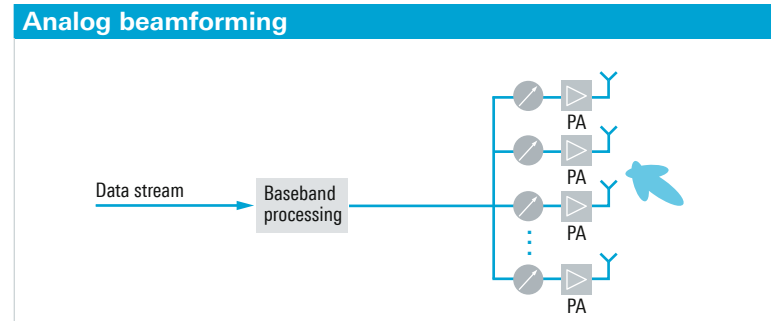

Digital beamforming

The more advanced architecture performs phase and amplitude weighting in the digital domain. Each antenna has its own transceiver and data converters, allowing it to handle multiple data streams and generate multiple beams simultaneously from one array. In addition to beam steering, null steering for interference reduction is also feasible. Digital beamforming requires A/D converters, making it challenging at higher frequencies.

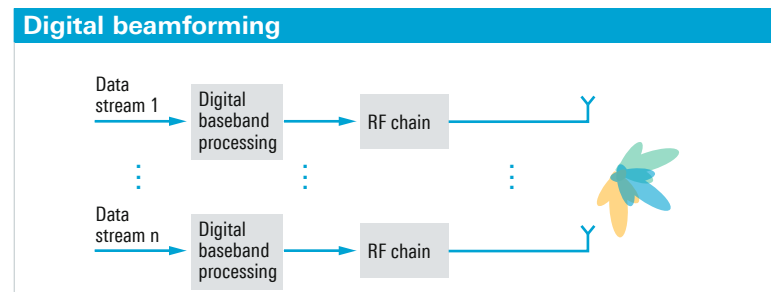

Hybrid beamforming

Hybrid beamforming balances the advantages and disadvantages of analog and digital beamforming. Targeting higher frequency ranges, such designs combine multiple antenna array elements into subarray modules that are connected to a digital preprocessing stage. System designers use hybrid beamforming to balance flexibility and cost tradeoffs while still meeting the required performance parameters such as number of simultaneous beams and frequency range.

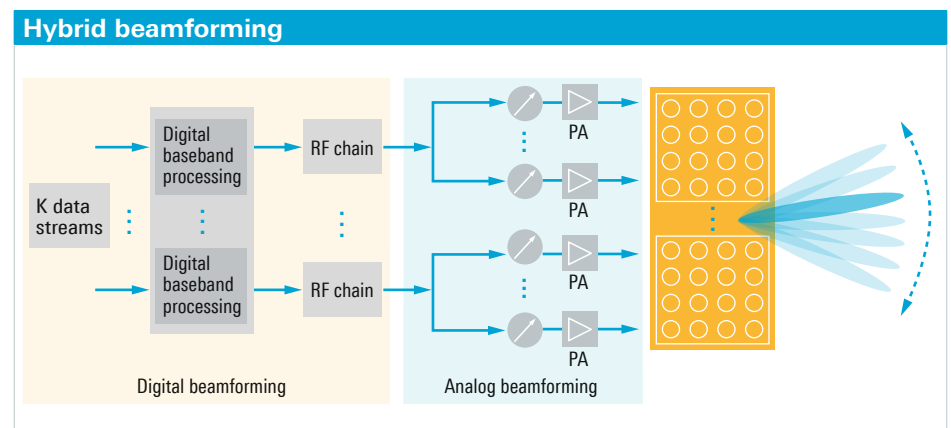

5. How do you connect the antenna array in a test setup?

The directivity of antenna arrays requires an over-the-air test setup, which raises the question of how to apply the test signal to the antenna under test (AUT). Passive antennas utilize the traditional testing approach in which a transceiver unit generates an RF signal that goes into an antenna array that converts the cable based RF signal into an over-the-air radiated signal. The approach of feeding an RF input to the AUT and measuring the RF output makes passive antenna testing straightforward and delivers comparable results.

For more flexibility, new trends are emerging that integrate some physical layer behavior into the antenna itself, with most RF signal generation steps performed in the antenna. These are known as active antennas, smart antennas or radio in-

tegrated circuit antennas. Such antenna arrays use a digital interface like CPRI as the input. This interface may be vendor specific and therefore difficult to access. One key challenge is how to obtain the phase information if the input signal into the AUT is unknown. It is a major challenge to perform EVM measurements in the near field when the phase information on the input signal is not available. Possible workarounds are to steer a beam by using a smaller number of antenna elements to “physically” reduce the aperture size, creating a far-field scenario. Test solutions from Rohde&Schwarz are based on a second transmit antenna placed at a constant distance to the AUT and with known input phase. This makes it possible to determine the phase obtained at the measurement antenna.

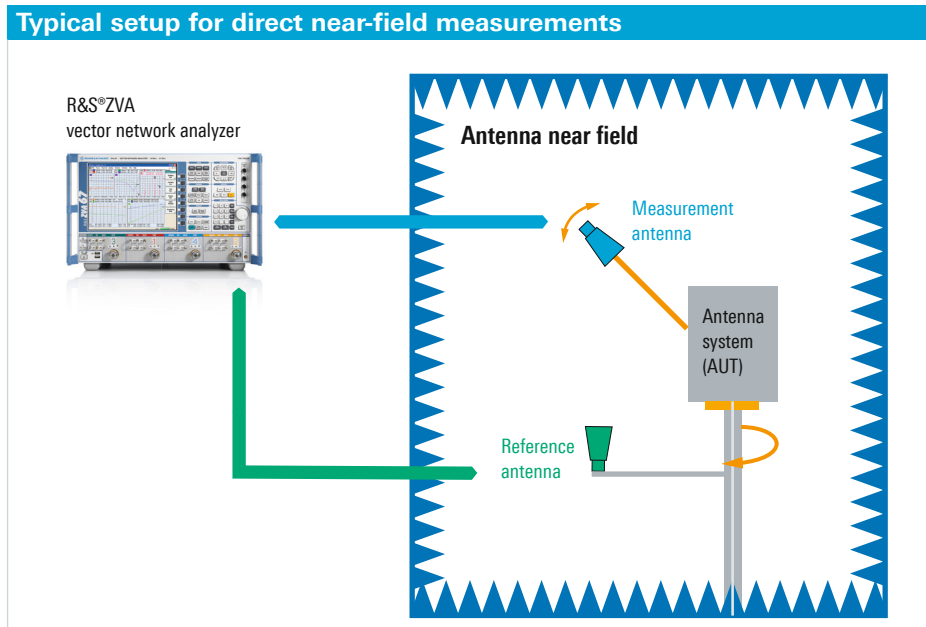

6. Are we in the near field or far field?

The distance between the antenna under test (AUT) and the measurement antenna is relevant for over-the-air (OTA) transmissions. The very near field, or reactive field, is the result of electromagnetic coupling at a distance smaller than the first Fresnel zone, with a typical range of only a few centimeters. This field is not suitable for OTA measurements since a measurement antenna becomes part of the radiating elements. Measurements in the adjacent radiated near field depend on magnitude and phase. It requires multiple sample measurements on a specific trajectory or surface and some postprocessing to convert the data to the far field, i.e. near-field to far-field transformation. The Fraunhofer distance is the border between the near field and far field and is calculated as $2D^2/\lambda$, where D is the aperture size of the antenna array and λ is the wavelength.

Rohde&Schwarz has proposed additional methods for near-field and far-field estimation. One is based on propagation aspects, presenting a kind of “trial and error approach” that uses power measurement variations when changing the measurement distance. Another approach is based on the half-power beamwidth that reduces the aperture size D into the size of the “radiating part” D* that is typically smaller. A further approach considers that only the main beam is of importance for massive MIMO OTA measurements such as EVM, resulting in a significantly reduced distance between the AUT and the measurement antenna.

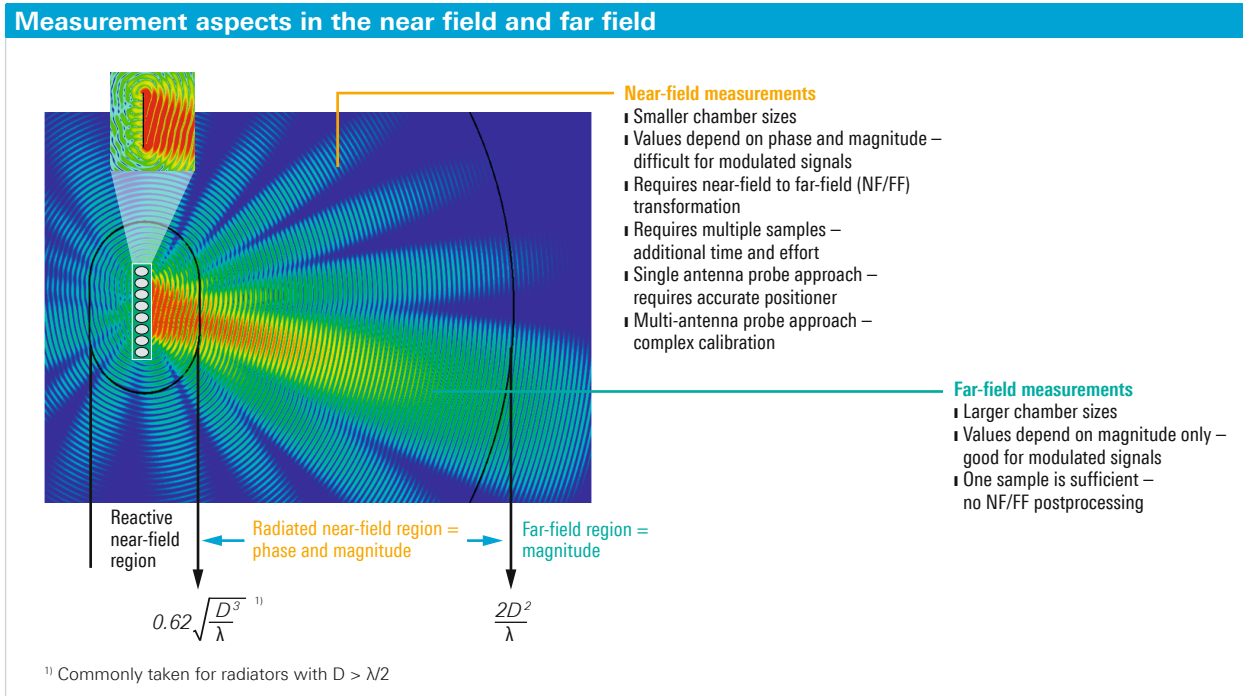

7. How do you create far-field conditions at short distances?

The theory recommends testing massive MIMO over the air under far-field conditions, especially EVM measurements, since the phase varies in the near field. The easiest method of generating far-field conditions is to extend the distance between the AUT and the measurement antenna as described by the Fraunhofer

equation. However, the increasing sizes of antenna arrays can lead to distances of dozens of meters. Therefore, several approaches deal with near-field to far-field transformation. There are three technical methods for generating far-field conditions at shorter distances.

Fresnel lens (Fourier optics)

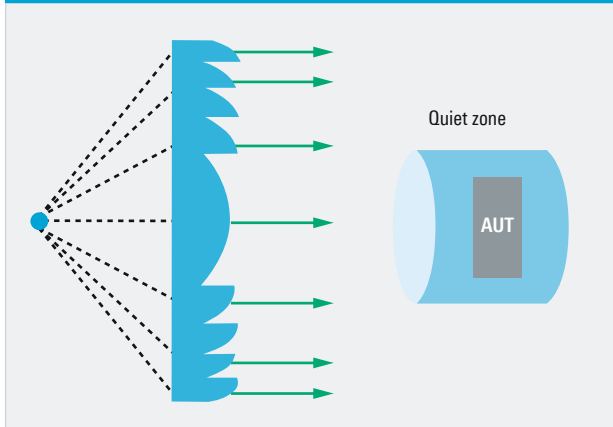

The idea of using a Fresnel lens is well known in the optical world. This principle uses a specifically shaped fiber lens to generate a planar wavefront. In the RF world, this method is rather complex and involves high costs, making it unfeasible for industrial applications.

Reflector: compact antenna test range (CATR)

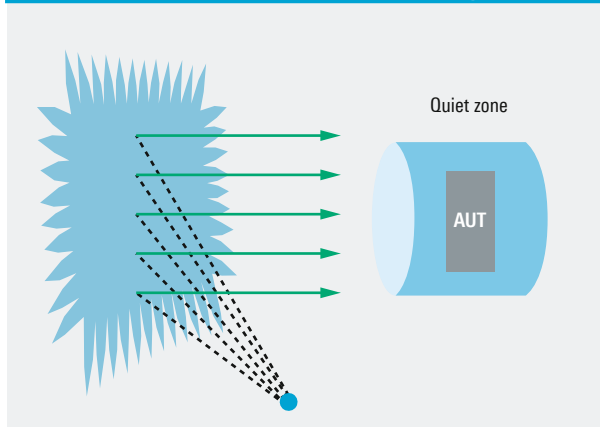

CATR is also well known in the industry. This concept uses a reflector that performs a “hardware” Fourier transformation to generate a cylindrical quiet zone – a zone where the observed phase difference to a plane wave is below a user-specific tolerance. The reflector size of a CATR system is typically around three times the size of the required quiet zone. The reflector material surface typically requires a roughness of about $\lambda/100$, and there are various reflector terminations such as serrated or rolled edges.

Plane wave converter (PWC)

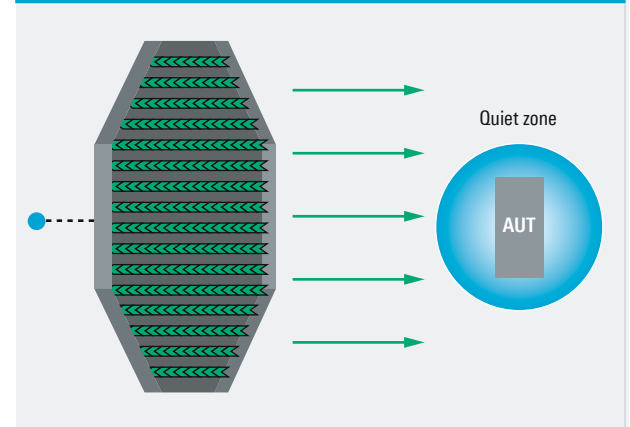

Based on antenna array design methods, Rohde & Schwarz developed a new PWC measurement system. Not aiming at directivity, the plane wave converter uses a large antenna array and phase shifters to generate a spherical plane wave of around 1 m diameter at a distance of approximately 1.5 m from the AUT.

8. What test equipment is needed for massive MIMO measurements?

Massive MIMO testing addresses a wide range of applications, taking into account technical aspects such as near field, far field, frequency, antenna type and parameters to be tested. Test configurations and tests considerably differ when testing in R&D, manufacturing and in the field. Upcoming application areas such as beamforming certification and verification and production-oriented testing will generate new demands when it comes to high accuracy, speed, costs, etc. Rohde&Schwarz has the widest range of products covering chambers, test equipment and software – a “one-stop-shop” for massive MIMO testing. In general, there are four key components to any massive MIMO measurement system.

Shielded chamber

Various sizes to cover near-field and far-field aspects, shielding and absorption capability, chamber access, etc.

Measurement antenna

Key considerations are frequency range, size and calibration.

AUT fixture or positioner

Massive MIMO testing of values such as EIRP, EIS and TRP requires a spherical pattern measurement with accurate and reproducible results, which means that the AUT and measurement antenna must be tightly secured at a known location for both calibration and measurements. In some cases, the spherical pattern is obtained based on rotation principles. Positioner precision is a must have for accurate results – especially in the case of near-field measurements where the data needs to be transformed into the far field.

T&M equipment

The required test and measurement equipment depends on the individual massive MIMO testing needs. A typical massive MIMO test system includes vector network analyzers, signal generators, signal analyzers, wireless communications testers, power sensors, etc.

Test setup based on a plane wave converter for active antenna arrays

Passive measurements

2D/3D antenna characterization

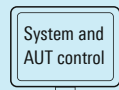

R&S®AMS32
OTA performance measurement software



R&S®ZVA
vector network analyzer

Active measurements

RF transceiver characterization:
adds RF measurements on modulated signals, e.g. EVM

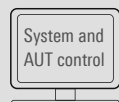

R&S®AMS32
OTA performance measurement software



R&S®SMW200A
vector signal generator



R&S®FSW
signal and spectrum analyzer

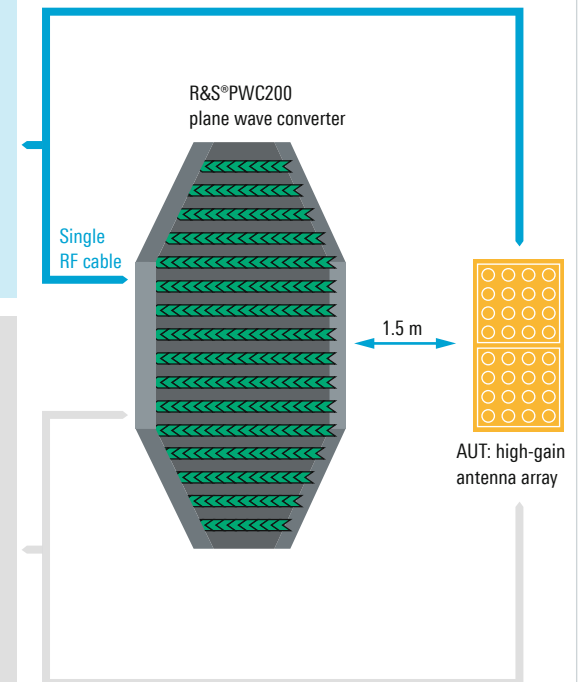

About Rohde & Schwarz

The Rohde & Schwarz electronics group offers innovative solutions in the following business fields: test and measurement, broadcast and media, secure communications, cybersecurity, monitoring and network testing. Founded more than 80 years ago, the independent company which is headquartered in Munich, Germany, has an extensive sales and service network with locations in more than 70 countries.

www.rohde-schwarz.com

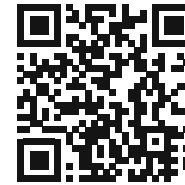

www.rohde-schwarz.com/5G

Regional contact

- Europe, Africa, Middle East | +49 89 4129 12345
customersupport@rohde-schwarz.com
- North America | 1 888 TEST RSA (1 888 837 87 72)
customer.support@rsa.rohde-schwarz.com
- Latin America | +1 410 910 79 88
customersupport.la@rohde-schwarz.com
- Asia Pacific | +65 65 13 04 88
customersupport.asia@rohde-schwarz.com
- China | +86 800 810 82 28 | +86 400 650 58 96
customersupport.china@rohde-schwarz.com



R&S® is a registered trademark of Rohde & Schwarz GmbH & Co. KG
PD 5216.2018.92 | Version 01.00 | October 2018 (he)
Trade names are trademarks of the owners
Massive MIMO
Data without tolerance limits is not binding | Subject to change
© 2018 Rohde & Schwarz GmbH & Co. KG | 81671 Munich, Germany



5216201892